

■ MONOTRIPHASE
○ TRIPHASE

☒ 230/400 V
☒ 400 V

GRU A MONTAGGIO RAPIDO
GRUE A MONTAGE RAPIDE
GRUA DE RAPIDO MONTAJE
GRUA DE MONTAGEM RAPIDA
QUICK SELFERECTING CRANE
HYDRAULISCHER SCHNELLMONTAGEKRAN

Montaggio – Montage – Erection – Montage – Montaje

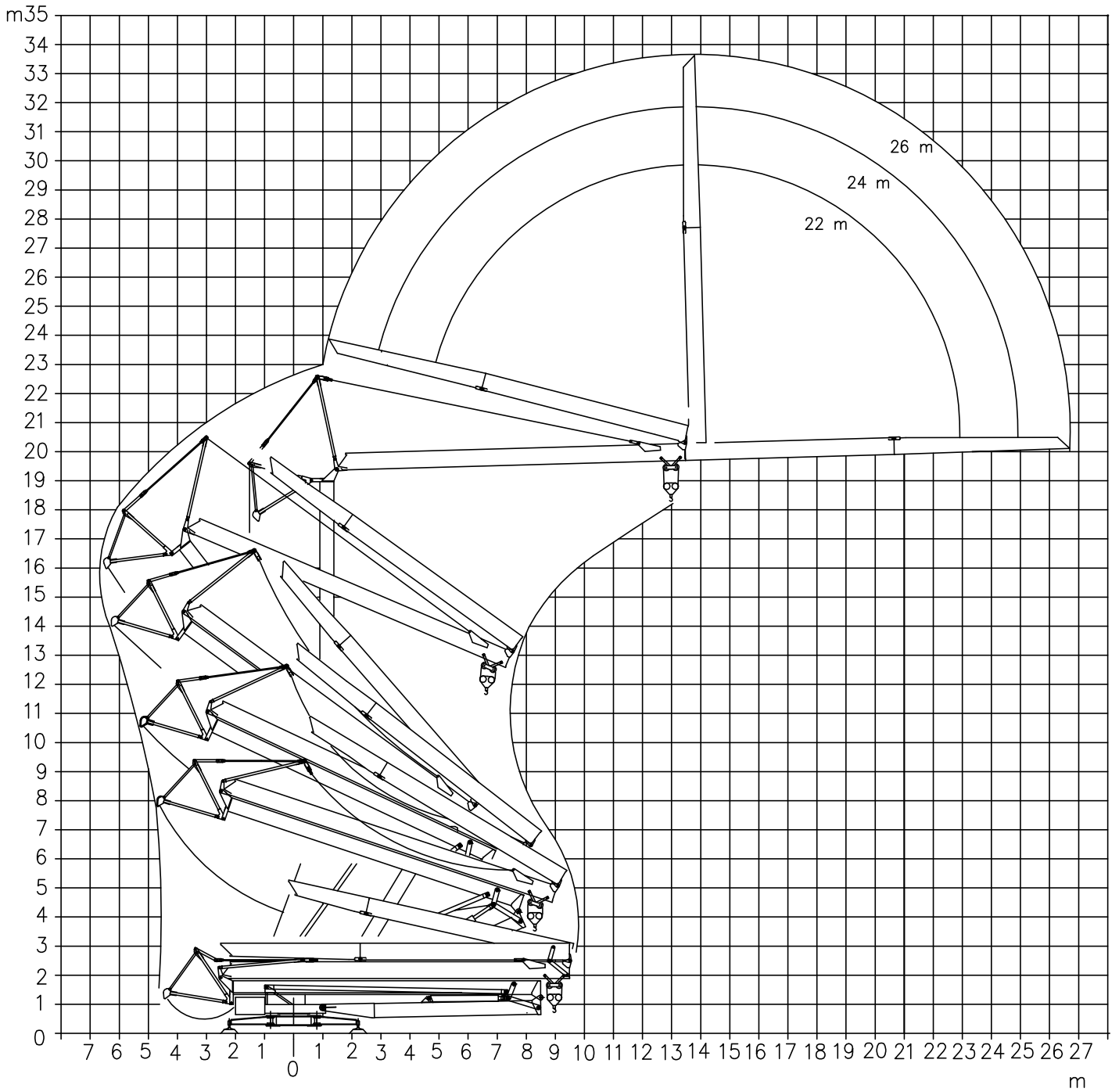



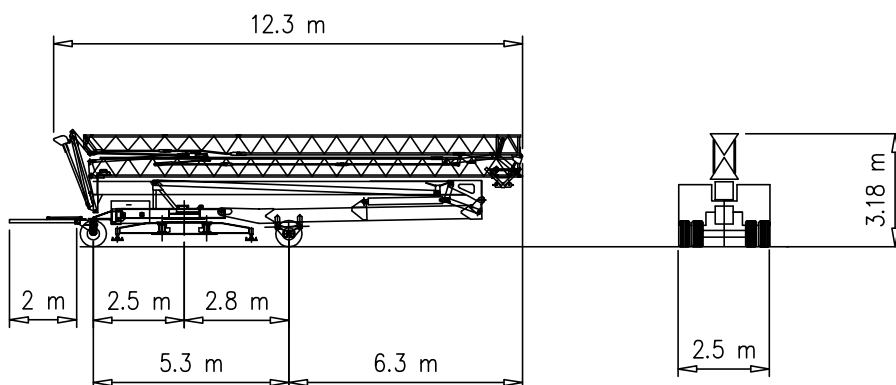







Trasporto – Transport – Transport – Transport – Transporte

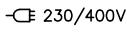

P1	kg	5620
P2	kg	9300
Ptot	kg	14920

Curve di carico – Courbes de charges – Load diagrams – LastKurven – Curvas de cargas

 TRIPHASE	 400 V	3	21	23	25	m	 MONOTRIPHASE	 230/400V	3	21	23	25	m
		600	600	600	600				kg	500	500	500	
 TRIPHASE	 400 V	3	10.8	12	14	16	18	20	22	24	26	m	
		2000	2000	1765	1465	1250	1080	950	850	760	700		kg
		3	11.8	12	14	16	18	20	22	24	m		
2000	2000	1930	1600	1365	1185	1045	930	850	kg				
3	12.4	14	16	18	20	22	m						
2000	2000	1720	1480	1230	1100	1000		kg					
 MONOTRIPHASE	 230/400V	3	13	14	16	18	20	22	24	26	m		
		1500	1500	1465	1250	1080	950	850	760	700		kg	
		3	15	16	18	20	22	24	m				
1500	1500	1365	1185	1045	930	850	kg						
3	15.5	16	18	20	22	m							
1500	1500	1480	1230	1100	1000		kg						
 TRIPHASE	 400 V	3	12	m									
		2000	2000		kg								
 MONOTRIPHASE	 230/400V	3	12	m									
		1500	1500		kg								

Reazioni – Reactions – Réactions – Eckdrücke – Reacciones – Reações

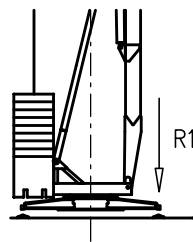





R1 ● 11.2 t ■ 7.7 t

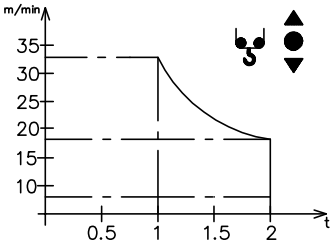

▲ 8.2 t ○ 13.4 t

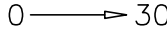

- | | | |
|-------------------------------|---------------------------------------|--------------------------------------|
| ● Reazioni in servizio | ● Reactions in service | ● Réactions en service |
| ■ Reazioni fuori servizio | ■ Reactions out of service | ■ Réactions hors service |
| ▲ Peso della gru senza assali | ▲ Dead weight without transport axles | ▲ Poids de construction sans essieux |
| ○ Peso zavorra rotante | ○ Ballast weight | ○ Poids du lest |
-
- | | | |
|--|--|---|
| ● Reaktionskräfte in betrieb | ● Reacciones en servicio | ● Em serviço |
| ■ Reaktionskräfte außer betrieb | ■ Reacciones fuera de servicio | ■ Fora de serviço |
| ▲ Konstruktionsgewicht ohne transportachse | ▲ Peso de la grua sin tren de transporte | ▲ Peso de la grua sem carro de transporte |
| ○ Ballastgewicht | ○ Peso de lastre | ○ Peso de lastre rotativo |

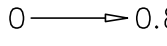

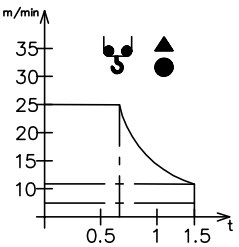
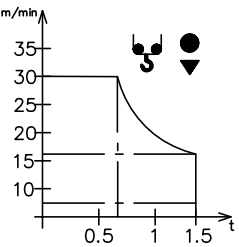
Meccanismi – Mechanisms – Mécanismes – Antriebe – Mecanismos – Montagem

3 PH	V7,5.30 Sollevamento Hoisting Levage Heben Elevaciòn Elevaçao					V7,5.32 5.5 kW (7.5 Hp) 12 kVA 
		m/min	4	16		
		t	2.0	2.0	1.0	

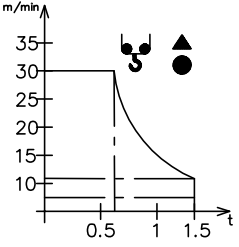
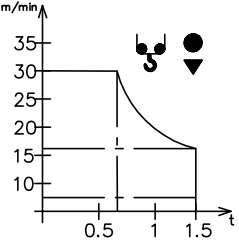
3 PH	Carrello Trolleying Distribution Katzfahren Distribuciòn Distribuiçao		1a		m/min	1.85 kW (2.5 Hp)
			1a			
	Rotazione Slewing Orientation Schwenken Orientaciòn Rotaçao		2a		giri/min tr/min rp/min	2.2 kW (3 Hp)
			0 → 0.8			

1/3 PH	V7,5.30 230 Volt Sollevamento Hoisting Levage Heben Elevaciòn Elevaçao						V7,5.32 5.5 kW (7.5 Hp) 11 kVA 	
		m/min	4	11				25
		t	1.5	1.5				0.7
								
			4	16	30			
			1.5	1.5	0.7			

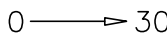
1/3 PH	V7,5.30 400 Volt Sollevamento Hoisting Levage Heben Elevaciòn Elevaçao						V7,5.32 5.5 kW (7.5 Hp) 11 kVA 	
		m/min	4	11				30
		t	1.5	1.5				0.7
								
			4	16	30			
			1.5	1.5	0.7			

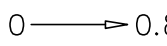
1/3 PH	Carrello Trolleying Distribution Katzfahren Distribuciòn Distribuiçao		1a		m/min	1.85 kW (2.5 Hp)
			1a			
	Rotazione Slewing Orientation Schwenken Orientaciòn Rotaçao		2a		giri/min tr/min rp/min	2.2 kW (3 Hp)
			0 → 0.8			

Rete elettrica – Réseau – Mains supply – Netzstrom – Red – Rede electrica	400V – 50 Hz
---	--------------

Potenza elettrica necessaria – Puissance électrique nécessaire Necessary electric power – Anschlusswert – Potencia electrica necesaria	3PH 12 kVA 1/3PH 11 kVA
---	----------------------------

 FMgru s.r.l.
 via Emilia 11-29010 Pontenure PC ITALY
 tel. 0523/510446 ric.aut. fax 0523/510365
 www.fmgru.it e-mail: info@fmgru.com

DIN 15018
 2000/14/CE



Documento commerciale non contrattuale
Per tutte le informazioni tecniche riferirsi
alle corrispondenti istruzioni

Unverbindliches Vertriebsdokument.
Für technische Informationen, siehe die
entsprechenden Anweisungen.

This commercial document is not legally
binding. For any technical information, please
refer to the corresponding instructions.

Documento comercial no contractual
Para cualquier información técnica,
ver la noticia correspondiente.

Code: 15ICA37B40A0	
Ed. Data	Rev Data
1 05.06.03	1 18.03.10