

**LINK-BELT
SPEEDER**

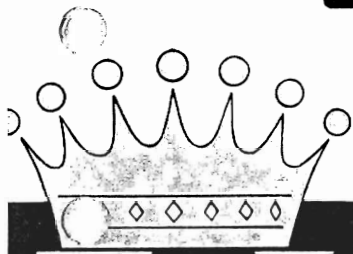

K-608
series

*Heavy-duty 3-yd.,
completely convertible
shovel-cranes*

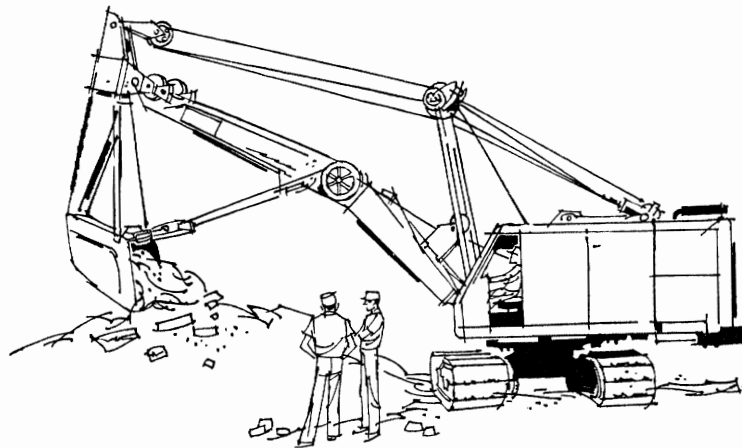
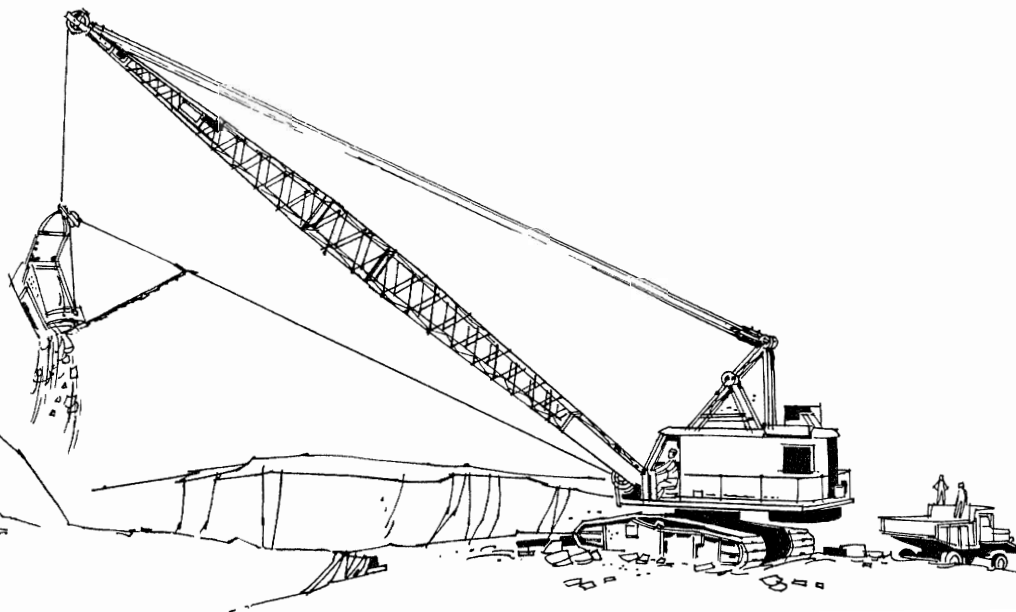
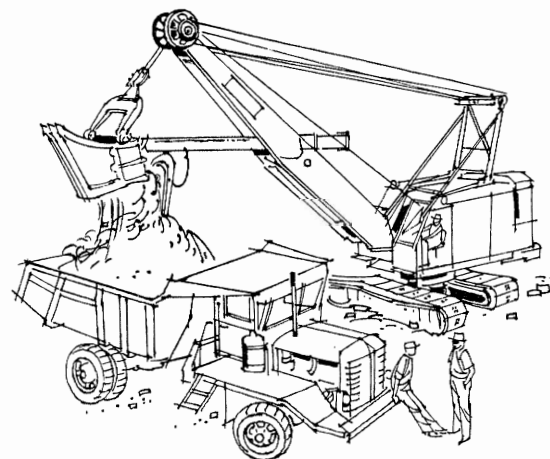



*perfect combination
of King-size*

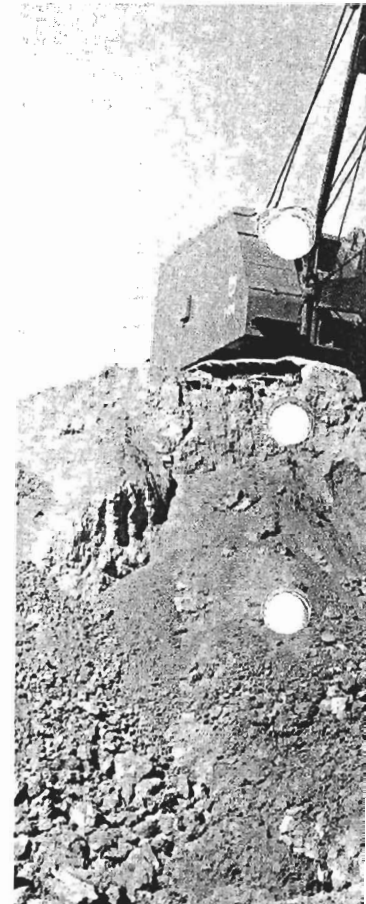

capacity, strength, power, speed and mobility

*out-produces larger machines . . .
out-maneuvers smaller rigs*

Here's a 3-yard machine with everything. Although it is definitely in the heavy weight class, it has the reflexes and speed of a "lightweight." The operator puts it through its paces at the mere flick of a fingertip. Response is fast, positive, smooth and precise. What's more, you've never seen power that follows the load like this. The engine torque converter package automatically provides perfectly matched power for any load. You get heaping dippers in a hurry . . . hoist, swing and dump or spot heavy loads with surprising speed and pin-point precision . . . eliminate needless wear and shock on the power train . . . save on fuel costs too.

Further, K-608 series machines are precision-made of quality components—with an extra measure of stamina to take full advantage of available engine power. There's extra size, strength and heft in shafts, gears, clutches and structural members.

Result—the K-608 series shovel-cranes are setting new high performance standards in the 3-yard class.

Table of contents

	PAGES
The King-size concept	3
Lower machinery	4-5
On-the-job maneuverability	6
Job-to-job transportability	7
Upper machinery	8-9
Centerpin trunnion and oscillating rollers	10-11
Speed-o-Matic controls	12-13
Shovel attachment	14-15
Crane attachment	16-17
Dragline attachment	18
Hoe attachment	19
The K-608 at work	Back cover

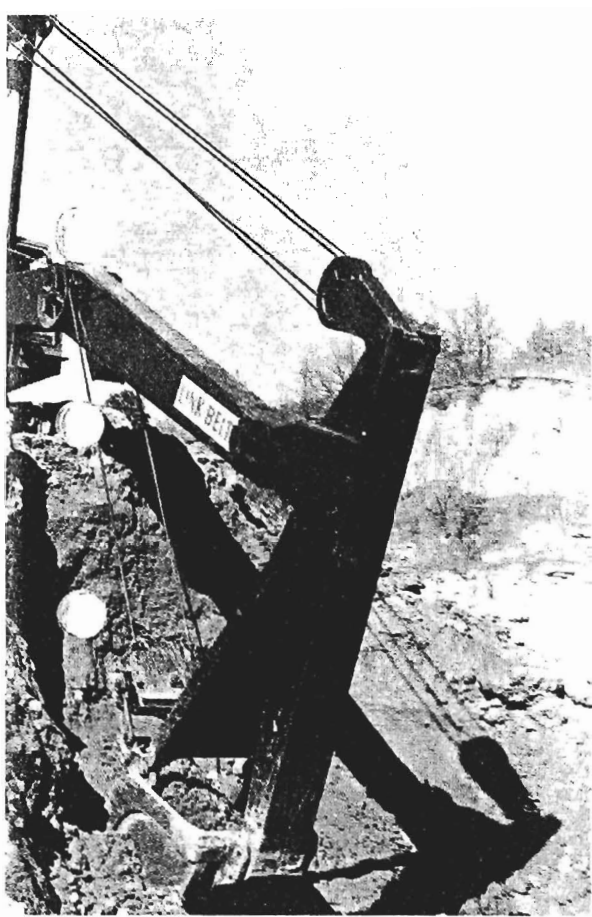

BIG REACH, BIG PULL, BIG BITE — The 3-yard K-608 series hoe has the reach, weight and power for deep digging and tough jobs.

SPEED, POWER, GUTS — The K-608 shovel socks dipper into cut with reserve power to hoist and swing, combines high productivity with low maintenance.

INSTANT RESPONSE, PERFECT CONTROL — K-608 draglines with free-spooling drums, plus power hydraulic controls, provide operator with long reach, extreme accuracy.

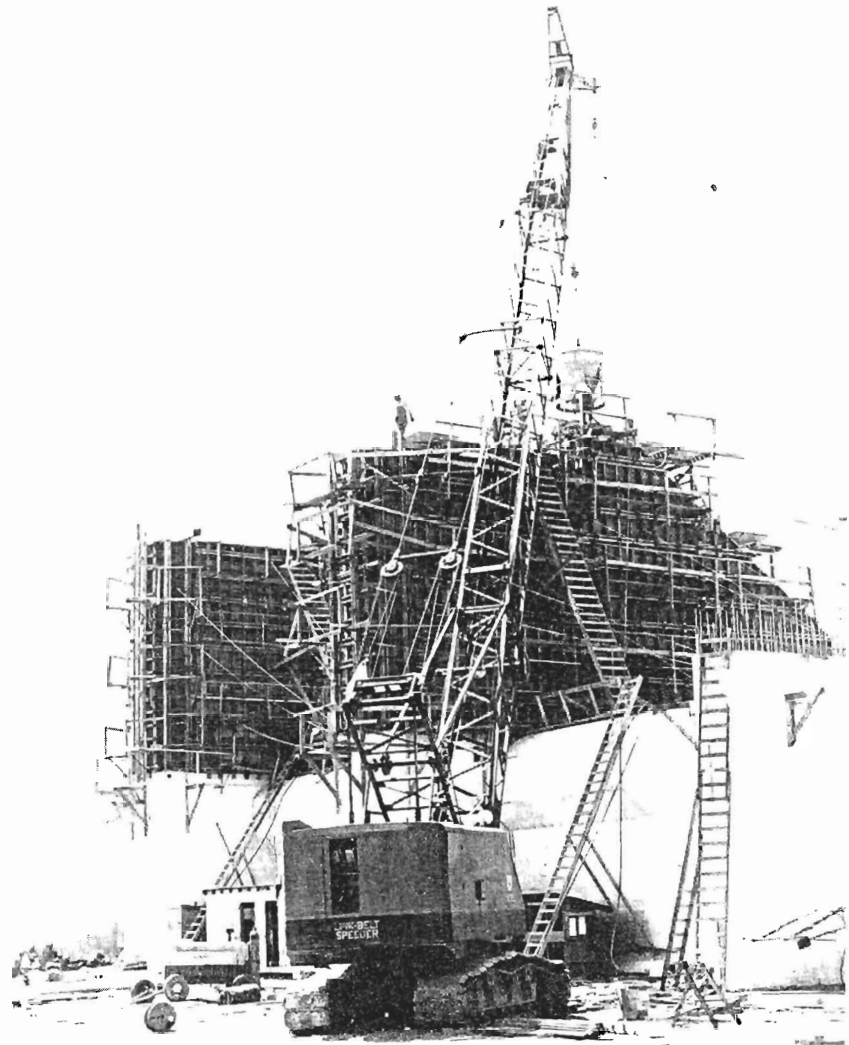
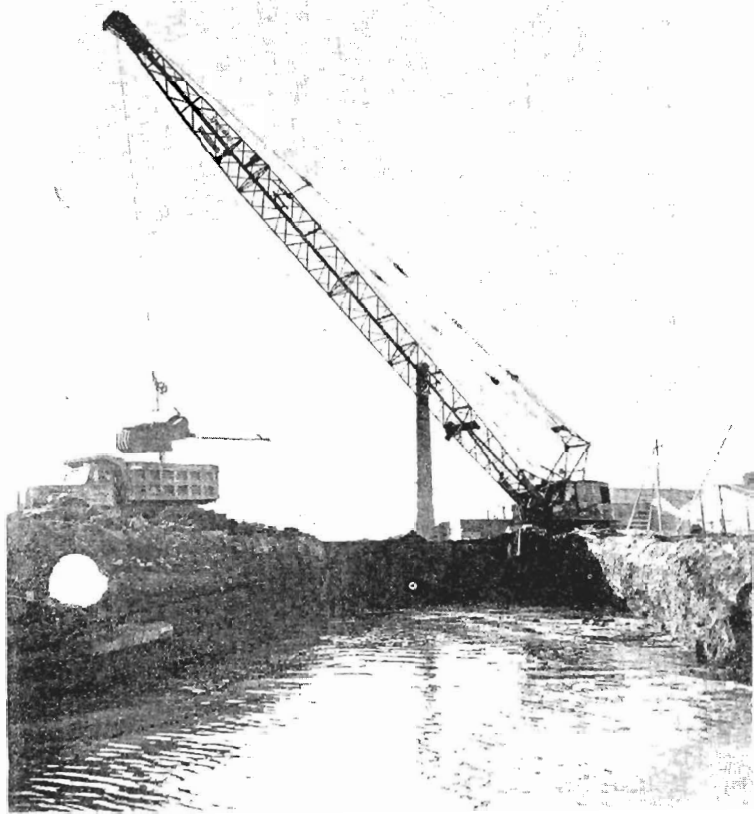

POSITIVE ACTION, NEEDLE-THREADING ACCURACY — Here's ability to handle large or small loads . . . spot 'em on a dime . . . with maximum safety—minimum effort.



*advanced structural
and component design
gives you . . .*

**extra
strength
...mobility
...stability**

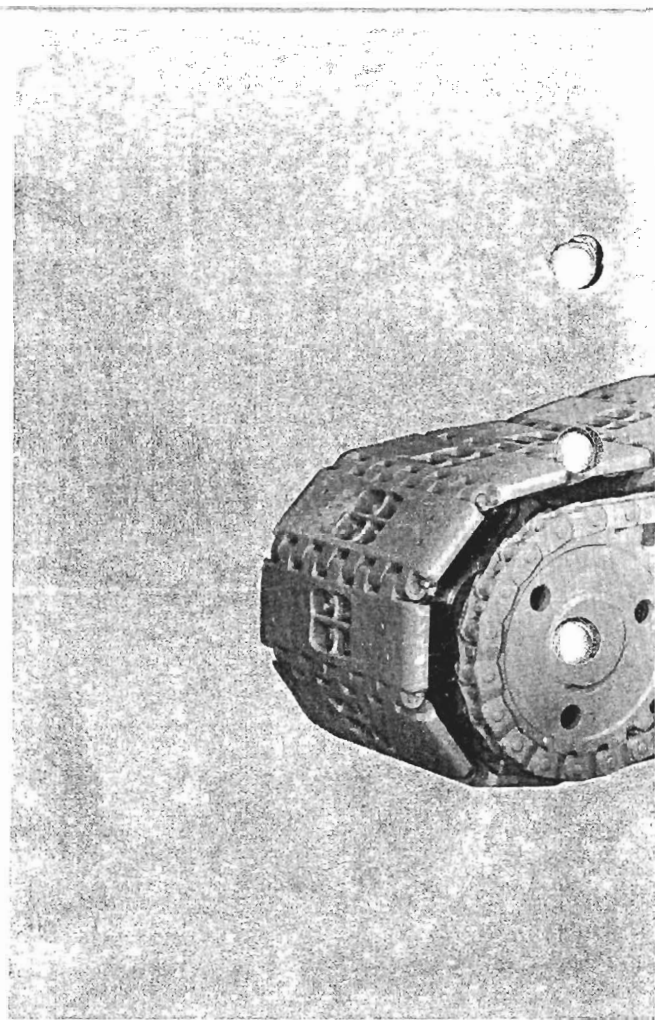

Whether your work requires the 7-roller side frame K-608 or the 9-roller side frame K-608L, you can be sure you'll get massive strength . . . ability to work in any footing.

Lower frames, including side frames, are of all-welded construction for great strength-to-weight ratio. Further, deep box section design and stress relieving of frames provides additional over-all strength.

Typical, too, of the K-608 Series' advanced design is the way the one piece traction shaft can be easily removed from the line-bored lower frame.

Fast, effortless hydraulic power steer

Hydraulics do the work, respond to the operator's fingertip pressure on the Speed-o-Matic levers . . . provide instant travel, or steer. No time wasted to "feel in" driving lugs or jaw clutches.

Result—you can easily walk the K-608 Series machines out of sprocket-high mud . . . maneuver quickly and easily in tight quarters . . . increase speed and safety on the job and when loading for job-to-job moves.

In addition, powerful springs individually set the traction brakes for positive steer . . . also act as automatic digging locks. There's no danger of runaway.

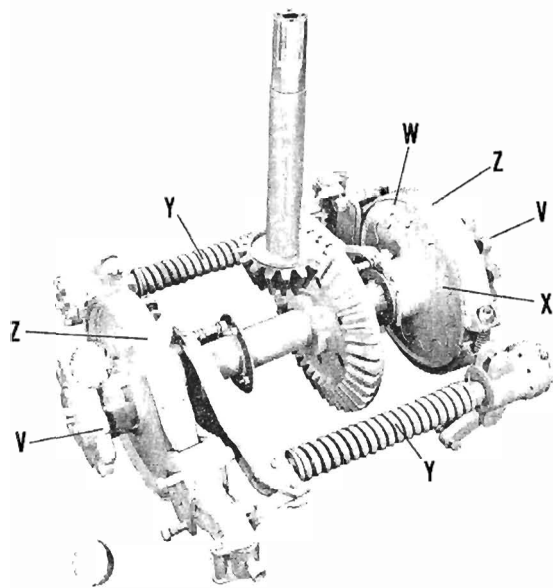
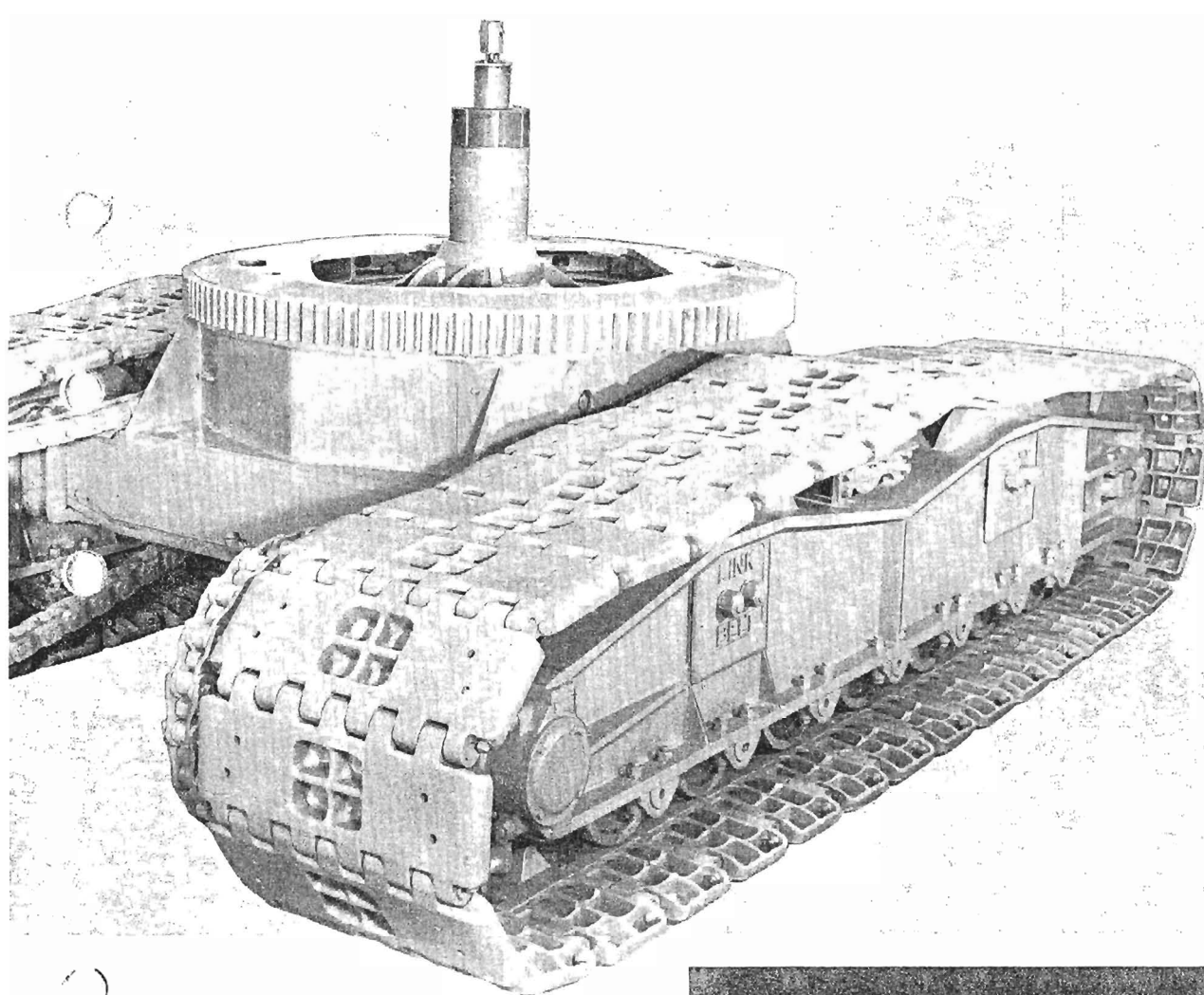

This illustration shows the power steer mechanism. The drive chain sprockets (V) are splined to brake drums (W) which float on the shaft and revolve only when sliding jaw clutches (X) are engaged with brake drums. Jaw clutches for either track can be engaged independently or simultaneously for steering. Spindles (Y) automatically apply the brakes (Z) which act as digging locks that hold the machine on any grade it can climb. Traction shaft bevel gears are machine cut, fully enclosed and run in oil.

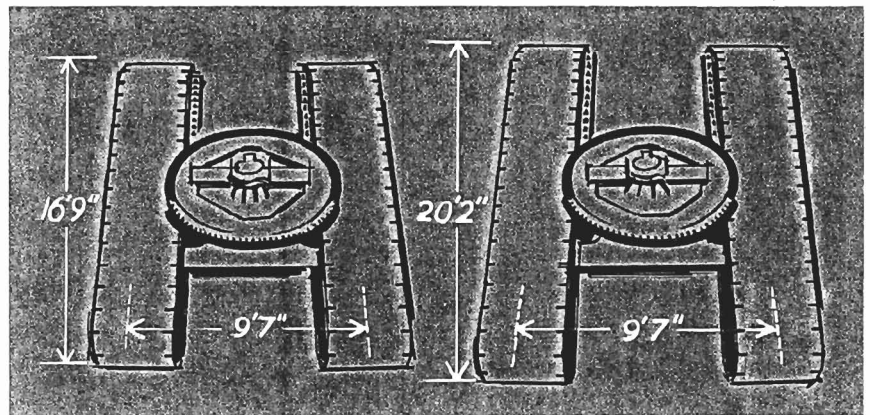

7-ROLLER SIDE FRAME LOWER (K-608)
—For crane, shovel, hoe, clamshell and dragline work. Over-all length 16' 9"; ground bearing length 14' 6". With standard 36" shoes, over-all width is 12' 7" and with optional 40" shoes, it's 12' 11".

9-ROLLER SIDE FRAME LOWER (K-608L)
—For greater ground bearing area and maximum stability. Over-all length 20' 2"; ground bearing length 17' 11". With standard 40" shoes, over-all width is 12' 11" and with optional 36" shoes, it's 12' 7".

PRECISION ALIGNMENT ASSURED
—Crawler base weldments are jig line-bored on machine tools that hold tolerances to utmost precision for perfect original fit, less wear and continuing alignment in the field.

STRESS-RELIEVING — By sustained heating of weldments, followed by gradual cooling, stresses incurred in welding are relieved. It's but one of many ways Link-Belt Speeder goes about building a machine with exceptional staying power.

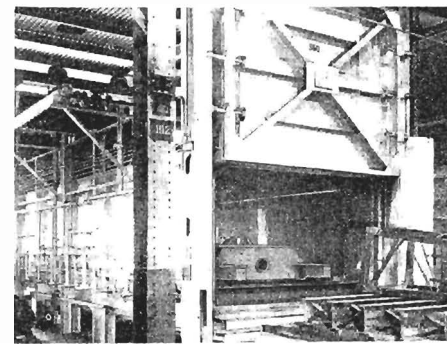
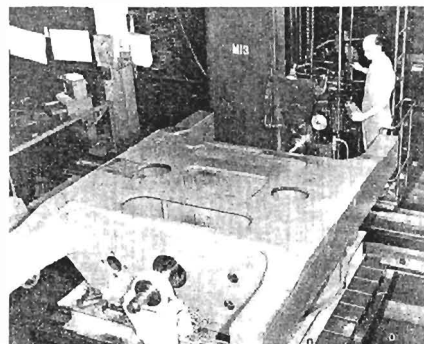

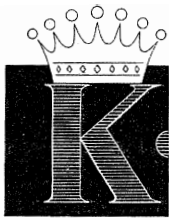

K-608 series / lower (continued)

on-the-job

maneuverability

THIS—

Improved fixed crawler drive shaft and sprockets are always in perfect alignment with drive chain and track. Shaft bearing supports are fully incorporated.

POSITIVE SPROCKET ALIGNMENT ENDS COMPROMISE ADJUSTMENT

Fixed shaft bearing supports hold sprocket shaft in positive alignment on the driving end of the crawler side frames. Chain adjustment is made by repositioning shims between cross frames and crawler side frames. There's no need to make

NOT THIS—

Misalignment is exaggerated in this diagram for illustrative purposes—but even slight misalignment which is difficult to prevent with any adjustable crawler drive shaft, causes serious bind and wear.

handline screw adjustments to "even up" tread and drive chain wear. There's no chance for twisting or side-cutting. Operation is smooth, power is fully utilized and crawlers, chains and bushings have longer, efficient life.

The speed of shifting from swing to travel, plus the ease with which the machine moves about, is truly startling. Speed-o-Matic hydraulic power shifting and steering increases safety and quickens maneuverability in tight quarters. There's no time or effort wasted for manual engagement of jaw clutches.

With its high (18 to 24 inch) ground clearance, fully enclosed traction mechanism and flat underbody, the K-608 walks through gumbo . . . clears obstructions that foul other rigs.

In addition, staggered lug, self-cleaning track shoes minimize need for maintenance.

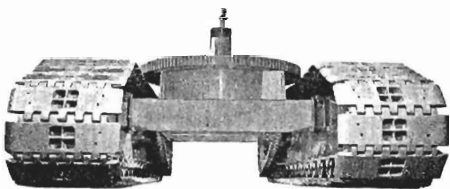

HIGH CLEARANCE, CLEAN UNDERBODY
—The 7-roller lower has 18-in. clearance . . . the 9-roller lower has 24-in. clearance. Both lowers have totally enclosed, fully protected traction shaft mechanisms.

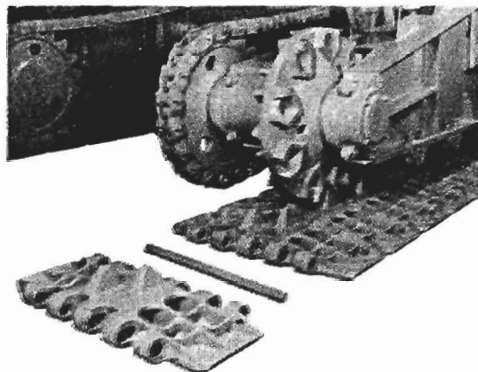

SELF-CLEANING TRACKS — Tread shoe lugs and drive sprocket lugs are non-clogging, staggered, double-row design. Short pitch, multiple-hinged shoes and full-floating track pins provide for smooth travel, prevent stress concentrations and minimize wear.

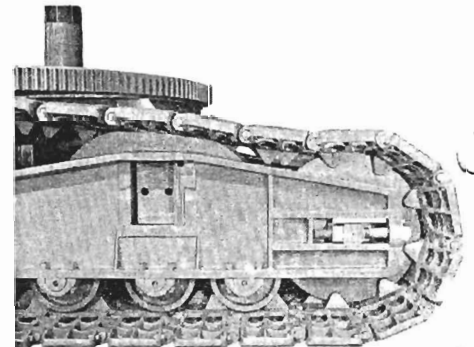

TRACK TAKE-UP — To prevent track buckling, slack is easily taken up at the idler end of the crawler side frames by screw-type adjustments.

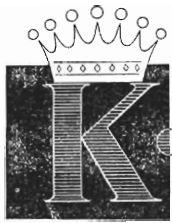

608 series / lower (continued)

job-to-job

transportability

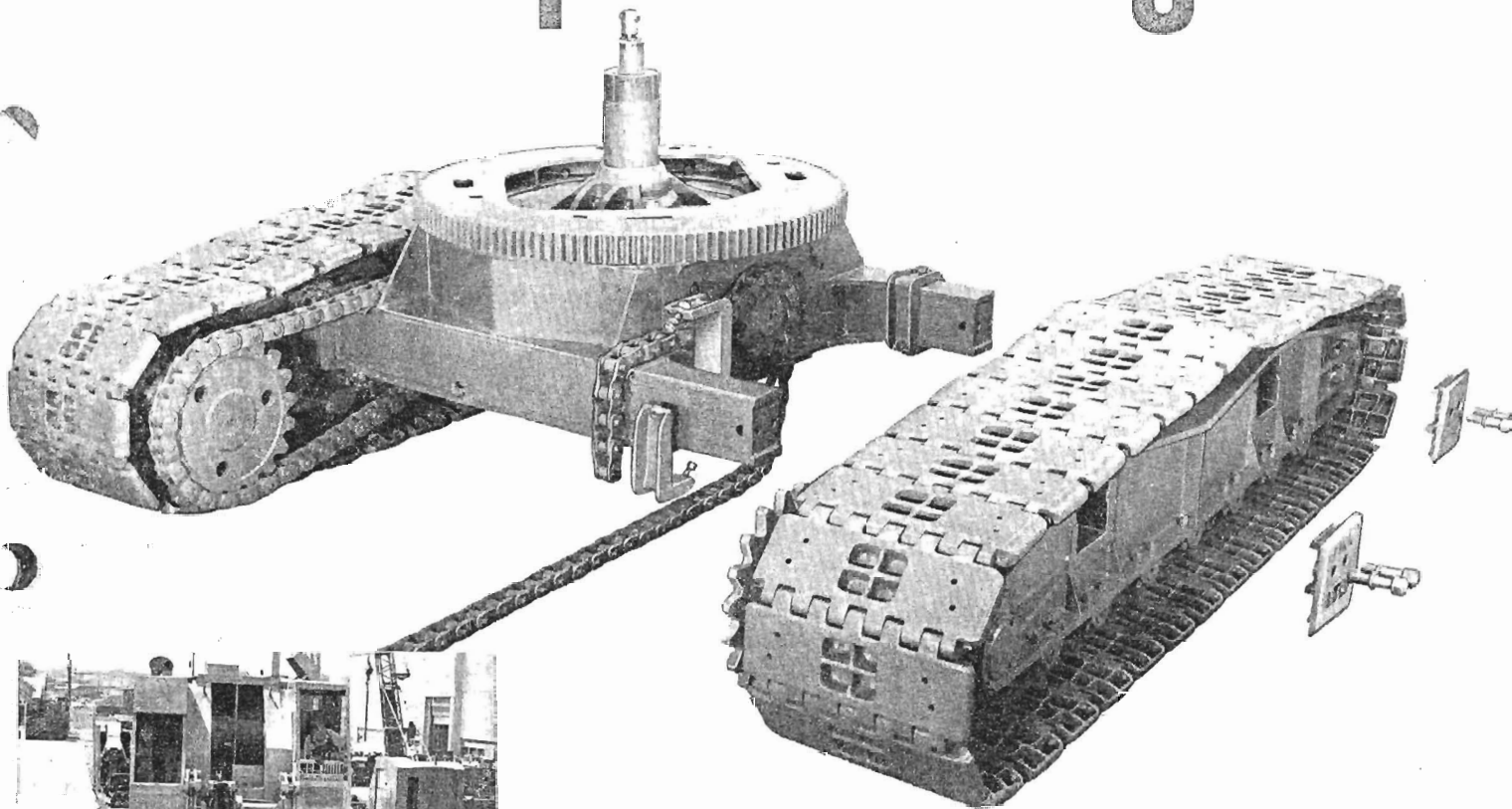

A Power steer to put the K-608 up the ramp and onto the rail car.

The advanced design of the K-608 series provides for job-to-job transport in considerably less time than many big rig owners believe possible. Telescopic crawler side frames can be moved in to reduce over-all width to 11' 7" with 36" shoes and 10' 6" with shoes removed. Crawler side frames can be removed by "breaking" the drive chain and removing the end plates and bolts from the cross axles (as illustrated).

When necessary, counterweight and/or front end attachment can be removed.

Then, too, hydraulic power steer makes it possible to "inch" left or right, jockey up narrow ramps for safe and easy loading. Either track can be operated independently. As a safety precaution, brakes automatically lock when steer clutches are not engaged.

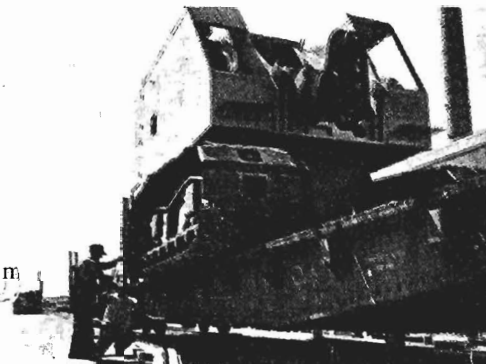

m Position machine properly on car. Pull bolts and end plates from cross axle.

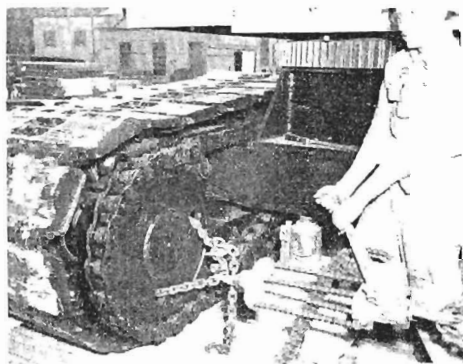

Jack up lower frame, break drive chain, remove cross-axle collars and retract crawler side frames.

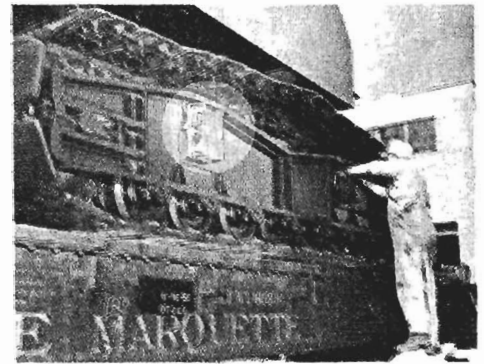

Insert locking pins in cross axles. Secure machine as required.



*Component design
and capacity—*

keyed for King-size production

The upper machine on K-608 Series machines provides a perfect combination of strength and design to handle the bonus horsepower available . . . precision machined components to assure smooth, low-loss power flow—easy convertibility to any front-end attachment . . . and precise “feel of the load” through Speed-o-Matic controls.

Other features offered on the K-608 Series uppers are positive independent chain crowd . . . extensive use of anti-friction bearings . . . free spooling drums . . . splined shafting . . . large Speed-o-Matic controlled external contracting band type drum brakes . . . variety of diesel engines available plus optional electric motor drive . . . torque converter drives . . . optional independent boomhoist . . . optional hydraulic swing brake . . . and many other profit producers.

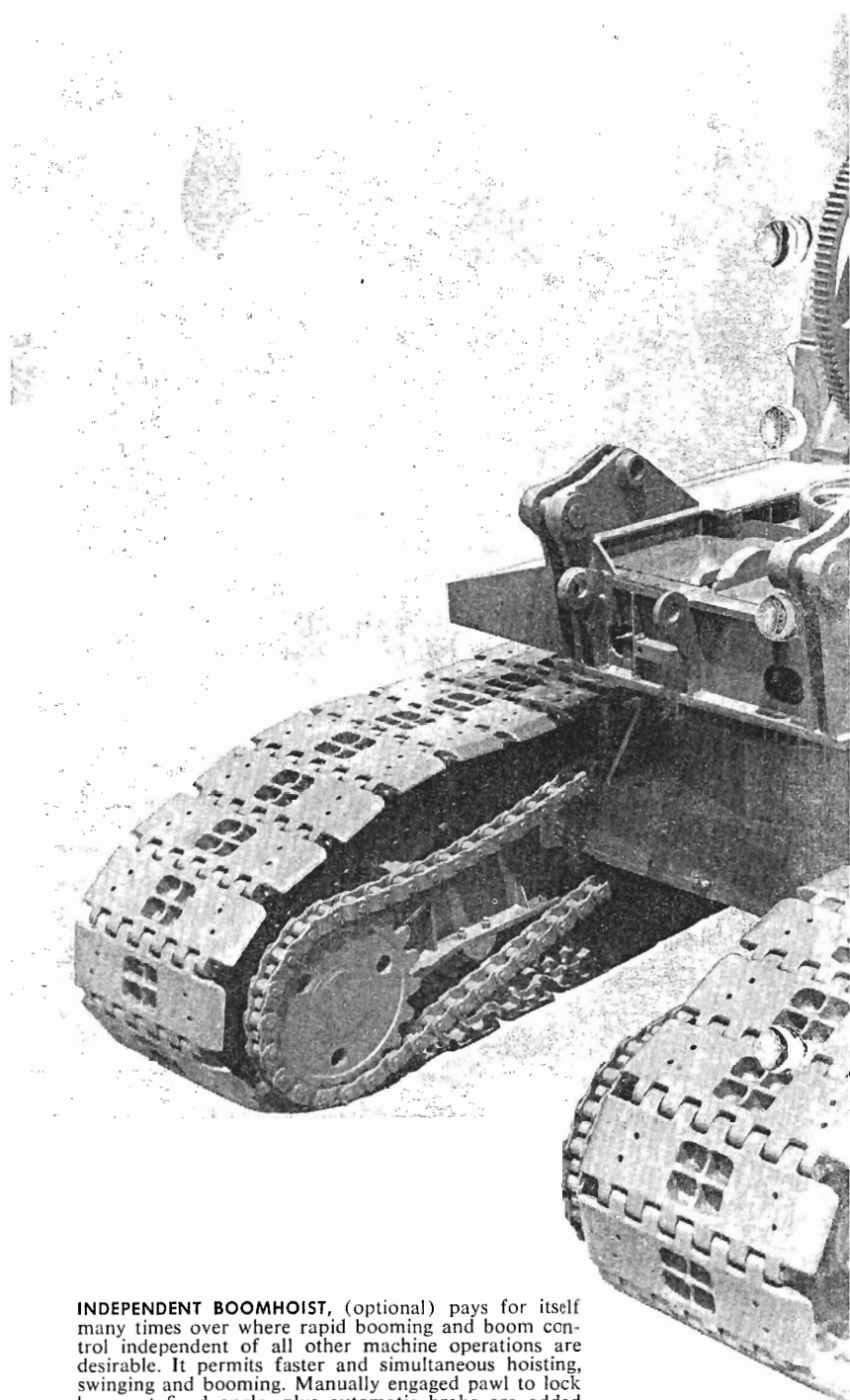

INDEPENDENT BOOMHOIST, (optional) pays for itself many times over where rapid booming and boom control independent of all other machine operations are desirable. It permits faster and simultaneous hoisting, swinging and booming. Manually engaged pawl to lock boom at fixed angle, plus automatic brake are added safety features. (Not available when machine is equipped as a shovel.)

STANDARD BOOMHOIST is a safe, fool-proof worm gear unit, driven by the main reverse clutches through a sliding spur gear. Brake is automatically applied. (Standard boomhoist not shown.)

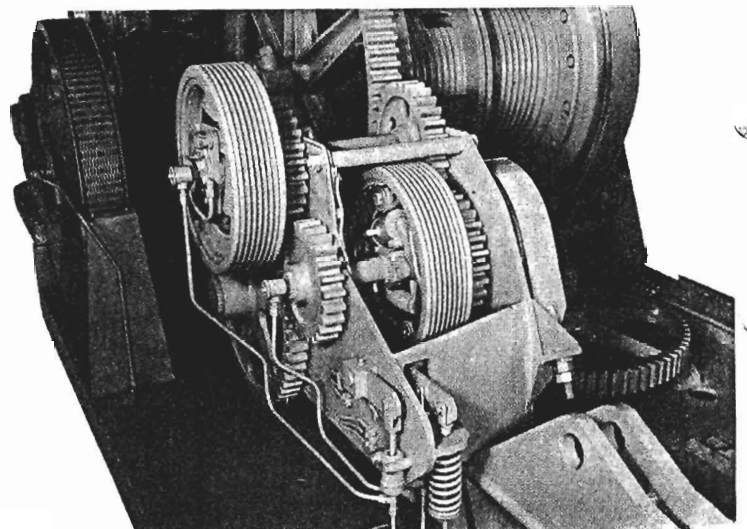

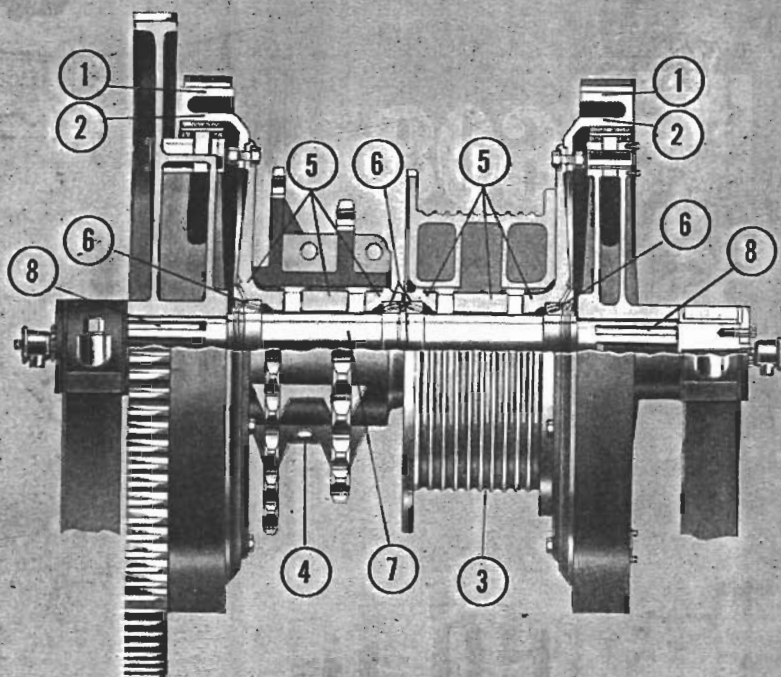
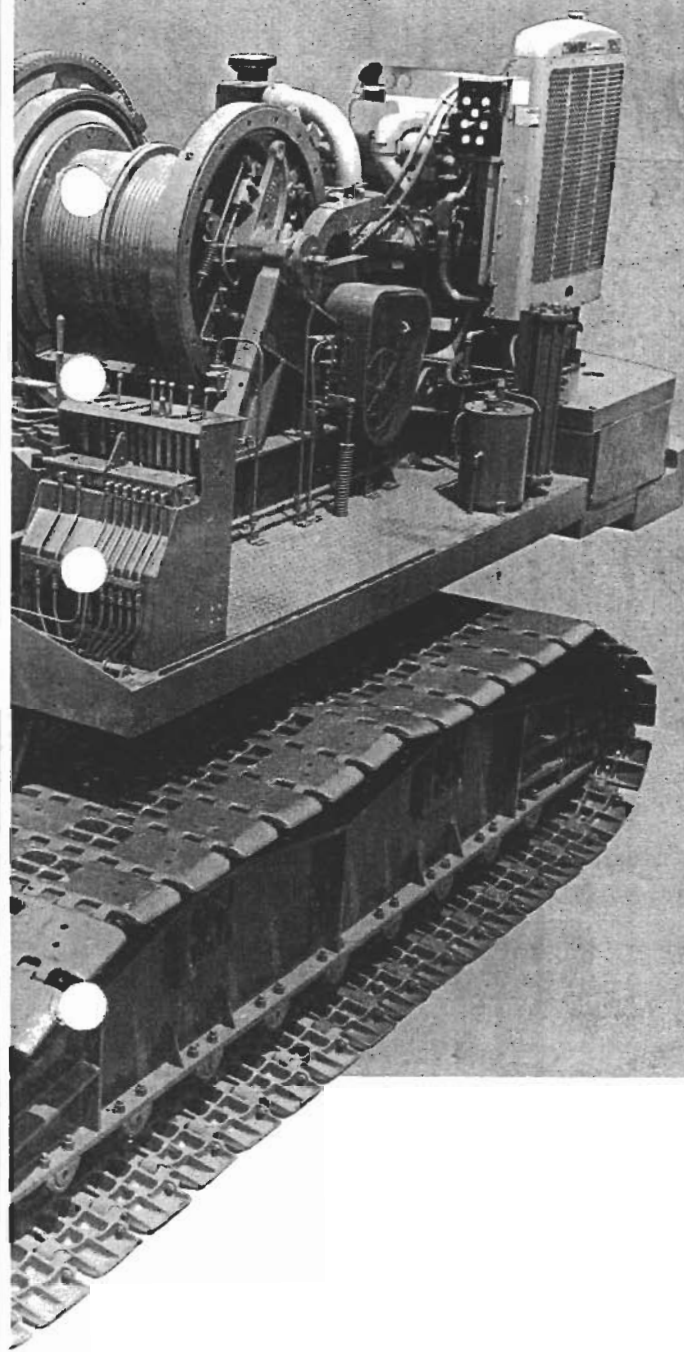

FREE-SPOOLING DRUMS

Alloy cast iron brake drum surface (1) for more reliable friction qualities is integral with clutch surface (2). The two surfaces are separated to prevent damaging heat concentration, allow cooler, longer lasting brake-clutch operation.

Easily removable, split cable lagging (3) and split shovel chain sprocket (4) attached to drum casting (5), which floats on anti-friction bearings (6) on the high-strength, precision-turned, alloy steel shaft (7).

Clutch spiders splined (8) to shaft.

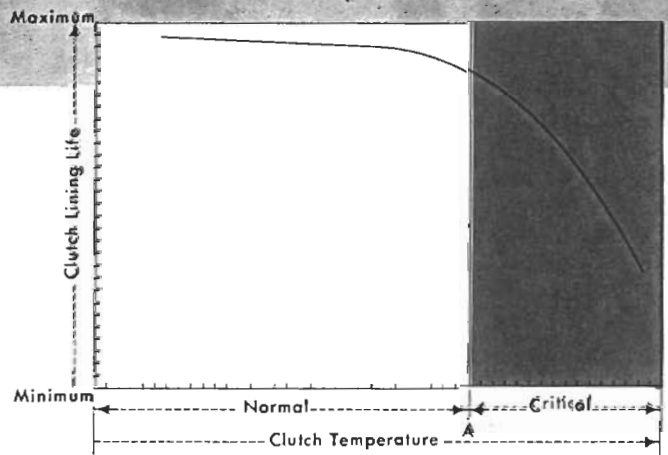

COOLED CLUTCHES. Chart (above) illustrates that clutch heat, up to a certain normal temperature (A), has very little effect on clutch life. As temperature increases beyond (A), lining life decreases out of proportion to the increase in clutch heat.

The K-608 features a unique blower system (below) that keeps hard working swingers extra cool—extends their life—minimizes service time by holding temperature below (A) where optimum clutch life can be expected.

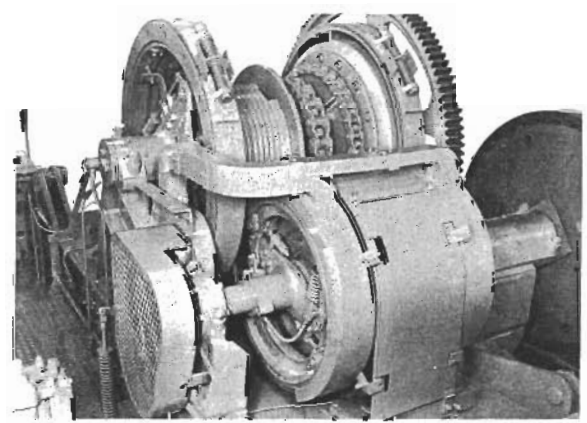

*ever before has a machine of this size
been so readily accessible . . . so easy to maintain*

- ☆ All-welded, stress-relieved, structural steel side housing arranged to provide easy access.
- ☆ Machined surfaces are provided to assure accurate power train alignment.
Deep, all-welded, stress-relieved frame provides more than ample reserve strength for the roughest going.
- ☆ Upper frame is jig line-bored to assure match and fit . . . eliminates uneven bearing—further minimizes chance for misalignment.
- ☆ Enclosed chain drive, running in oil, is the most efficient power transmission on the market. Shock-absorbing characteristics minimize engine and machinery wear, extend life.
- ☆ All gears have machine-cut teeth for smooth meshing and long life.
- ☆ Drum laggings are split for easy removal . . . fast, front-end attachment changes.

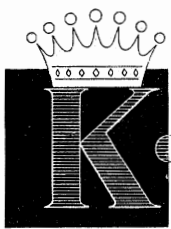

608 series / upper and lower

Exclusive centerpin trunnion

eliminates concentrated

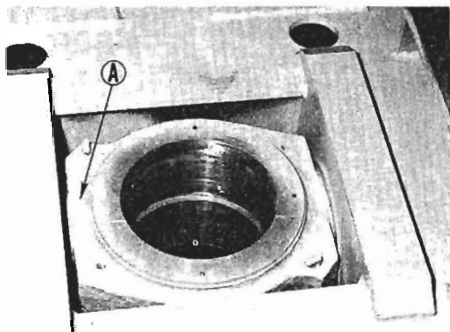

Centerpin trunnion (A) at left, is mounted on trunnion axles (B), see illustrations below, permitting the upper to oscillate freely when under load.

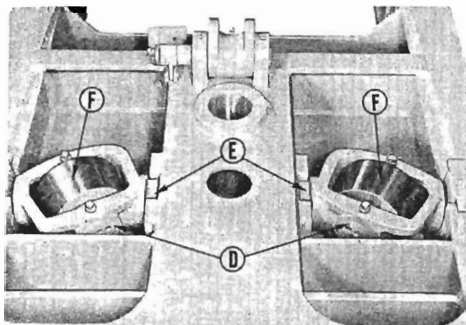
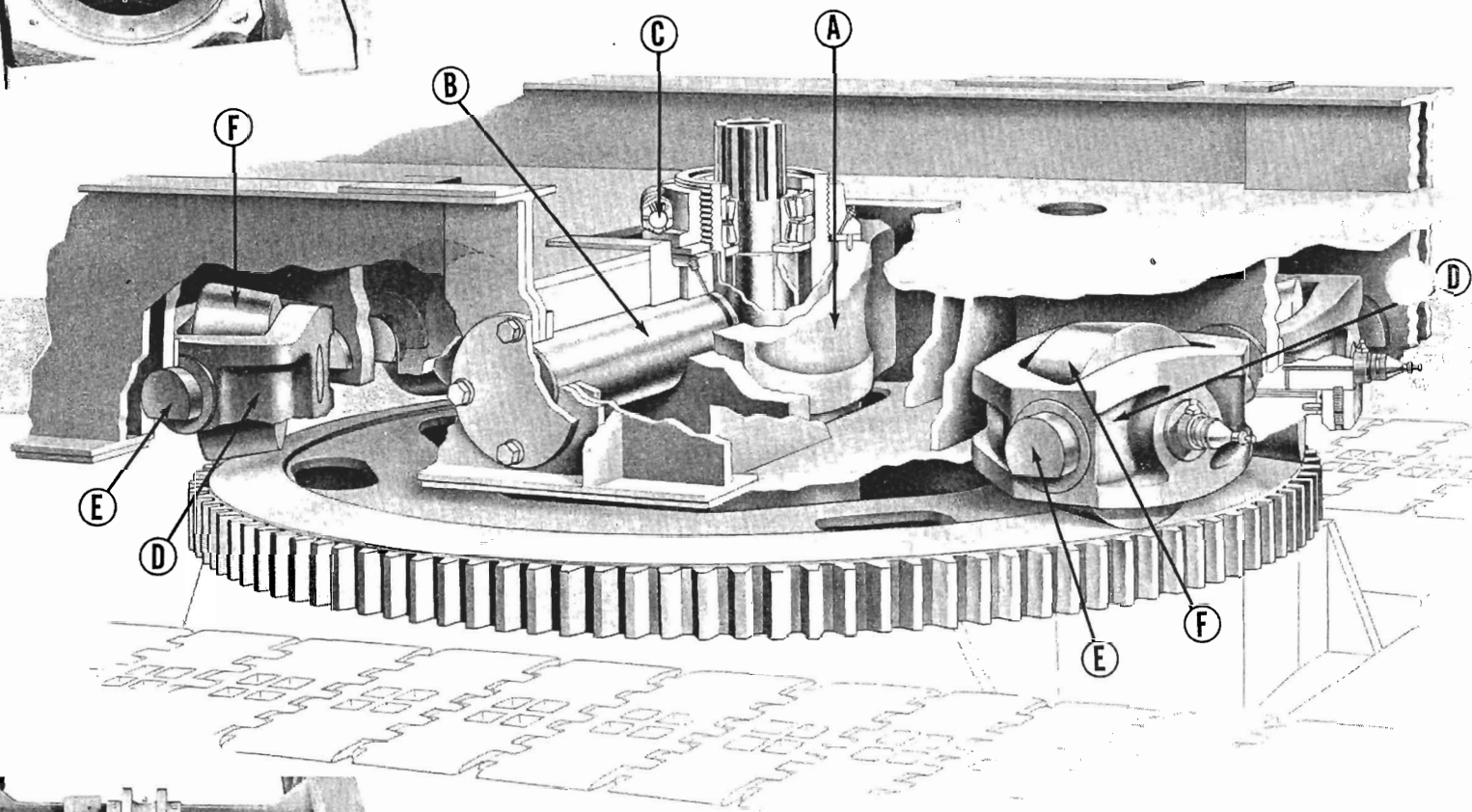

Looking at the underside of the upper rotating base—conical roller mounting brackets (D), which have cast integral trunnion axles (E), contain conical rollers (F). Note centerpin trunnion axles (B) in centerpin bearing housing.

and oscillating roller design

centerpin loadings

Exclusive, self-aligning centerpin trunnion distributes load evenly.

The effectiveness of this design in preventing centerpin and centerpin bushing wear is amazing.

The centerpin trunnion assembly equally distributes loads against the full face of the centerpin and centerpin bushing . . . prevents shearing or slapping action—even under the heaviest loadings. The trunnion also evenly distributes vertical loadings against the centerpin nut (C). There's negligible wear . . . more confidence on the part of the operator to take on tough cuts or lifts without "babying" the machine.

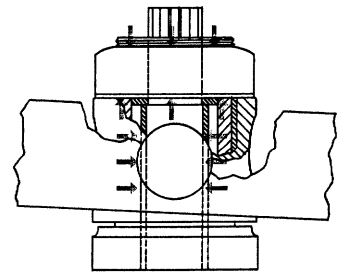

THIS—In the Link-Belt Speeder design, the rotating base is trunnioned to the centerpin. Note, despite tilting action of the upper, there's perfect alignment of the centerpin and the centerpin bushing plus full-length distribution of loadings to minimize stress and wear on centerpin. There are no concentrated bending loads on the centerpin and no prying action on the centerpin nut.

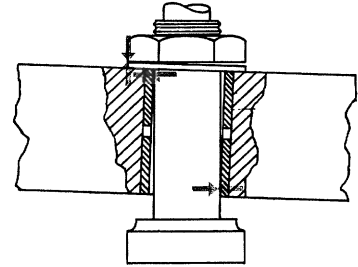

NOT THIS—Without the exclusive centerpin trunnion design, tilting action of the rotating base causes concentrated bending forces on the centerpin and prying action on the centerpin nut. These concentrated stresses and unequal loadings gouge the centerpin bushing when swinging. This creates soaring maintenance and repair costs—not to mention the cost of downtime.

Only Link-Belt Speeder oscillating conical rollers assure full-face contact with the roller path under all conditions . . . preserve roller, roller bushing and roller path life.

Conical roller design combined with the matched taper on the roller path allows roller to follow a true circular path without the peening or scuffing typical of cylindrical rollers.

This feature provides further evidence of the advanced design and engineering that go into Link-Belt Speeder K-608 Series models. Like the self-aligning, centerpin trunnion above, these pivoted, oscillating roller assemblies eliminate concentrated stress and punishment. Precision-machined conical rollers and tapered roller path pay off in longer life, less maintenance and uninterrupted work schedules.

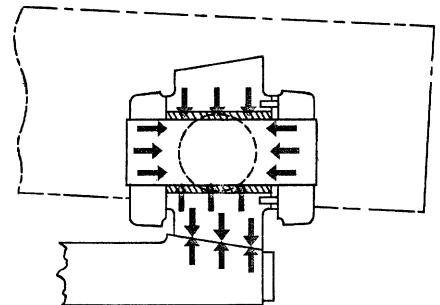

THIS—When normal tilting action of the upper revolving frame occurs, the roller brackets pivot. This action maintains full-face contact between roller and roller path, distributing loads evenly and equally. This design also permits closer, tighter adjustment of the upper to the lower . . . eliminates shock loadings.

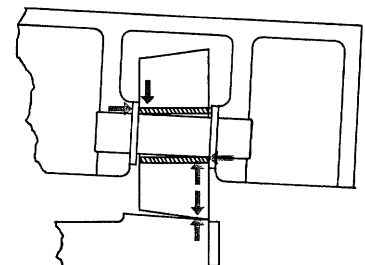

NOT THIS—In conventionally designed machines with fixed rollers, the rollers cannot oscillate and automatically adjust for full-face contact. Result—pin-point loading, extreme bushing and shaft wear, peening of the roller edges and roller path.



608 series / control system

Exclusive Speed-o-Matic power hydraulic controls

reduce operator fatigue... make response fast, precise

SPEED-O-MATIC CLUTCHES

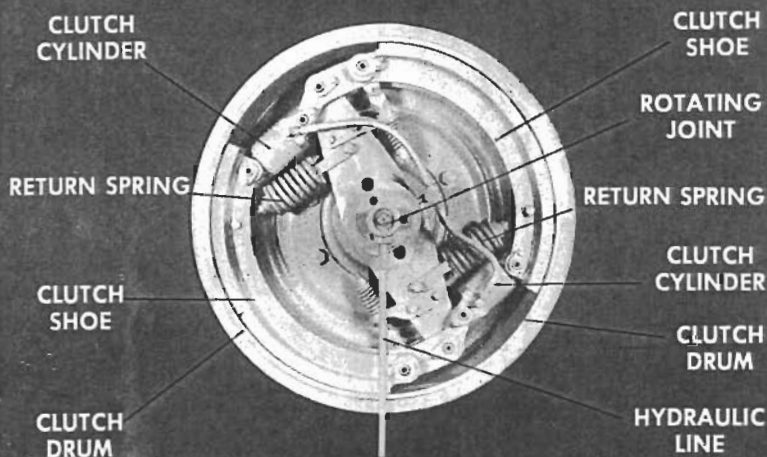

SWING CLUTCH is an internal-expanding, two-shoe type.

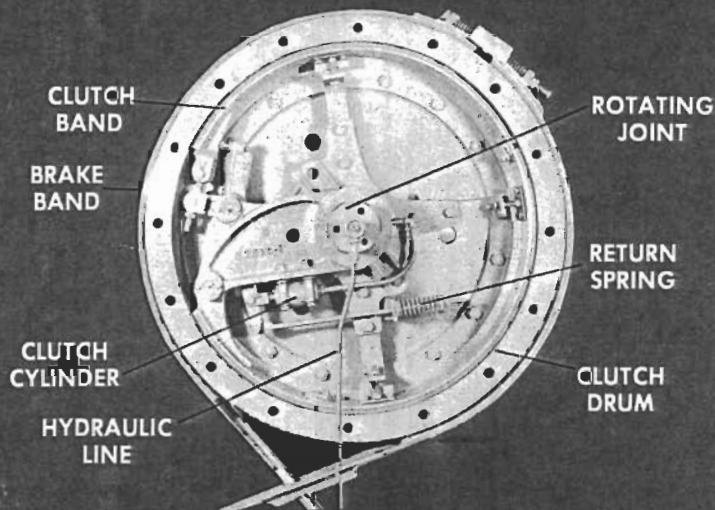

DRUM CLUTCH is internal-expanding, band-type.

*Developed by Link-Belt Speeder—
proved outstanding in the field*

Speed-o-Matic, standard on all Link-Belt Speeder models—has been thoroughly proved by the success of thousands of Link-Belt Speeder owners since 1936. Speed-o-Matic is a true power hydraulic control system. It's far superior to manual, air or hydraulic-booster type controls.

At the flick of his wrist, the Link-Belt Speeder operator can put his machine through its paces. Response is fast, and positive—without jerk, jump or lag. And there's perfect "feel" of the load at all times through variable pressure control valves.

*Self-adjusting
hydraulic-actuated clutches*

Speed-o-Matic clutches make it unnecessary for the operator to adjust clutches in the morning and again as the work progresses. Weeks, and in many cases months, may pass before even a minor adjustment is needed. That's because hydraulic-actuated pistons automatically compensate for normal lining wear and heat expansion.

Oil, under pressure, flows from hydraulic tubing through rotating joint and into clutch cylinder. When variable pressure control valve is actuated, pressure within the cylinder increases proportionately to the pressure exerted on the control lever. This causes the cylinder piston to extend, which in turn engages the clutch with the clutch drum.

Oil under pressure does the work

In the Speed-o-Matic control system, oil pressure (provided by a compact, engine-driven pump) does all the work . . . delivers power for all operating functions of the machine. This system is unaffected by day-to-day atmospheric variations, does not require priming or bleeding. Only seasonal oil changes are required. It eliminates control rods, collars, bell cranks and other fast-wearing parts normally found in mechanical or booster-actuated clutches. Also, Speed-o-Matic ends the annoyance and hazards of jerk, jump or lag common to other systems.

As shown in the diagram at right, oil pressure in the accumulator tank is maintained between 900 and 1050 psi with pump working against pressure approximately 5% of the time. By means of variable pressure control valves, the operator can meter pressure to each operating clutch. This means the operator is always sure of prompt, positive, smooth response.

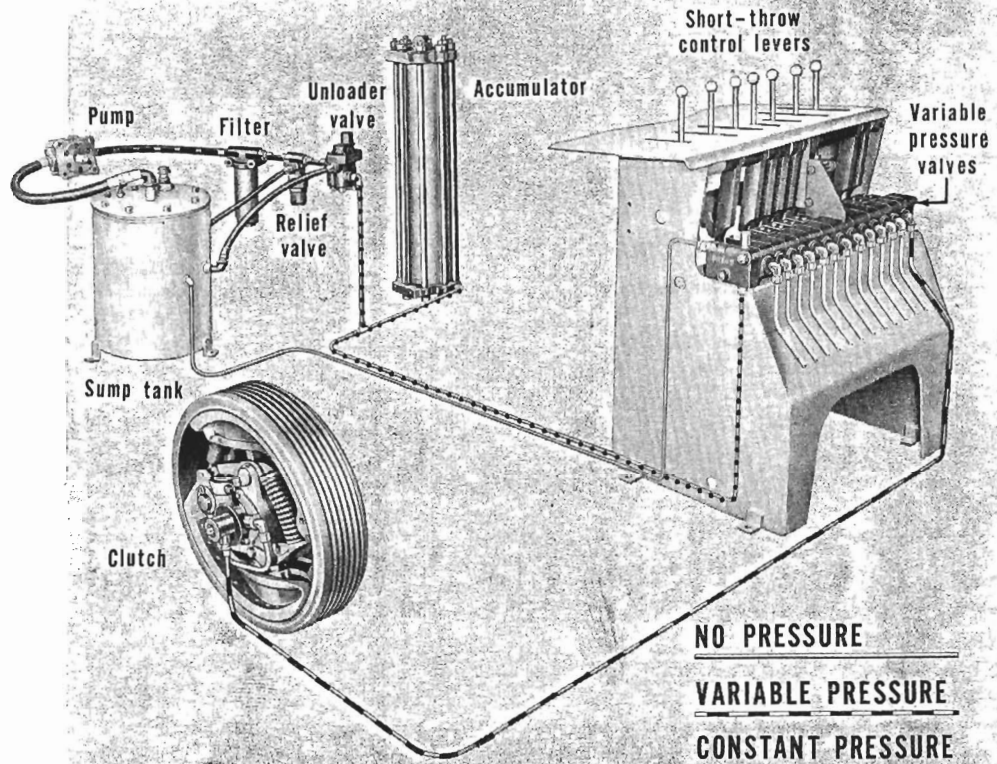

Short-throw levers make operation a breeze

Conveniently located, Speed-o-Matic controls make the operator's job far less fatiguing . . . keep him fresh and alert throughout the shift . . . minimize end-of-the-shift letdown . . . encourage the operator to take fullest advantage of the machine's high productive potential.

Time studies reveal that the operator can realize up to 25% more productive cycles per 8-hour shift than can the man with a manually controlled machine.

The fingertip-operated Speed-o-Matic control levers on the standard control stand at right are:

1. Swing and travel (also standard boomhoist)
2. Swing-travel gear shift
3. Swing jaw clutch
4. Swing lock
5. Steer control
6. Steer control
7. Hydraulic shift for standard boomhoist
8. Right drum (shovel crowd and retract)
9. Left drum (hoist and dipper trip)

Other controls are:

10. Master clutch
11. Right drum Speed-o-Matic brake pedal
12. Left drum Speed-o-Matic brake pedal

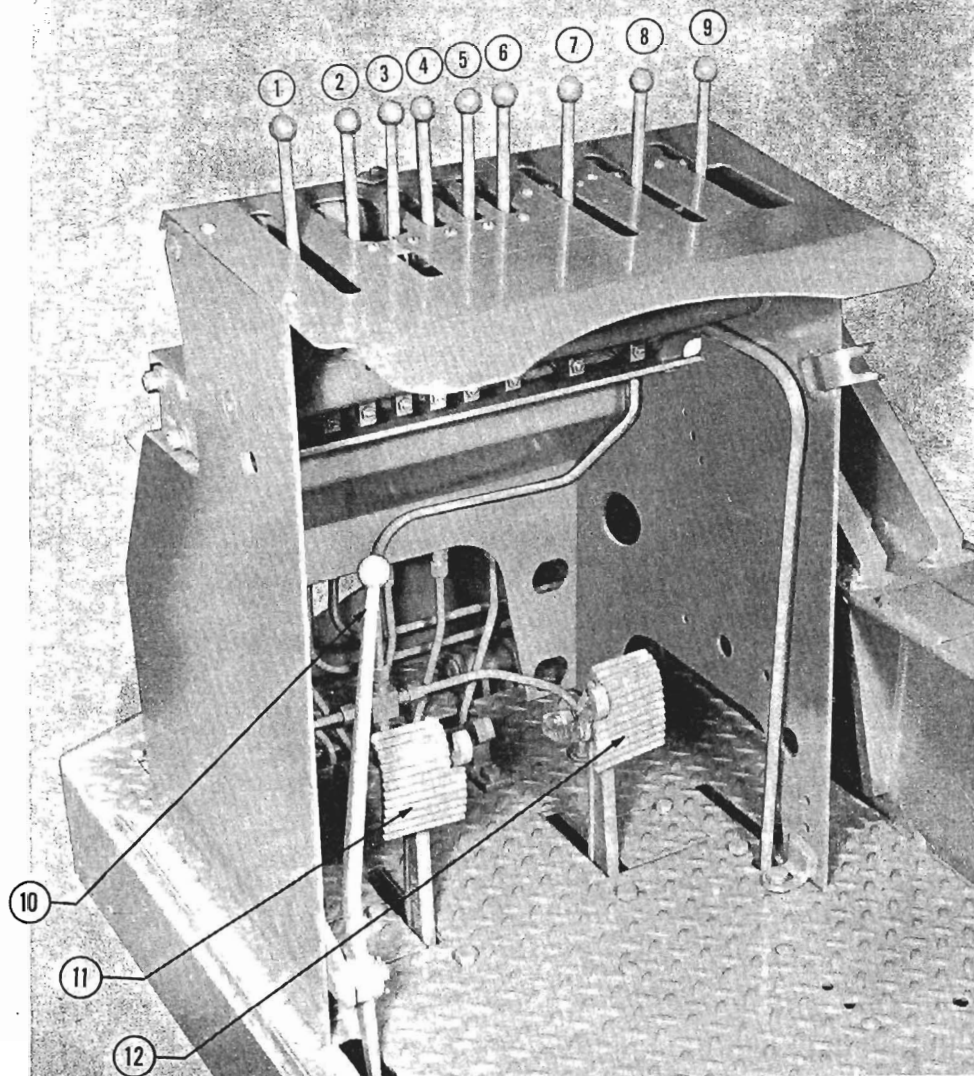



608 series / shovel attachment

King-size strength

Here's a machine that's built for heavy rock work. Witness the boom and dipper stick . . . all-welded and stress-relieved.

A one-piece saddle block (see photo below) provides maximum support at all times. Replaceable wear plates protect dipper stick and saddle block.

When it comes to crowding—socking the bucket in, coming up with a full load—positive independent chain crowd really does the job. You get full application of every bit of horsepower at the K-608 shovel's command!

An optional stripping shovel attachment with extra long boom and stick is also available—giving that extra reach for greater profits!

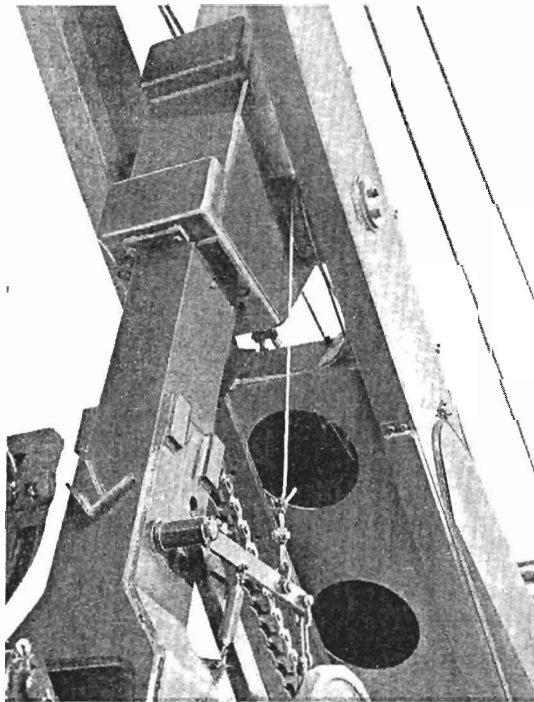
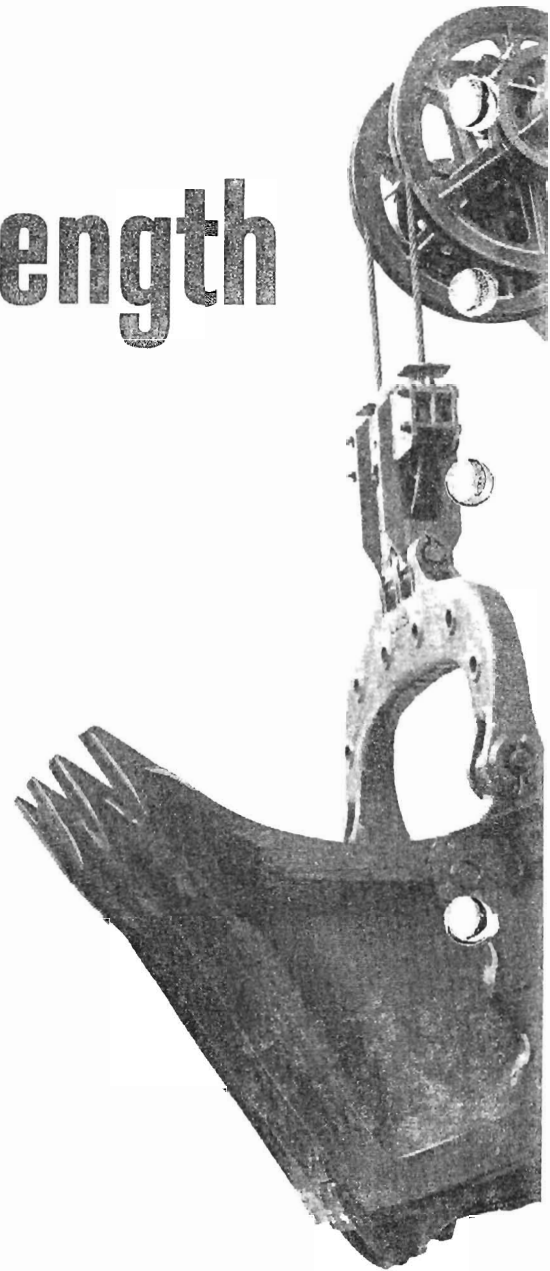

HYDRAULIC DIPPER TRIP—Speed-o-Matic controlled, this dipper trip on the hoist lever is easily instantaneously actuated. Bucket door is released by a flick of the wrist.

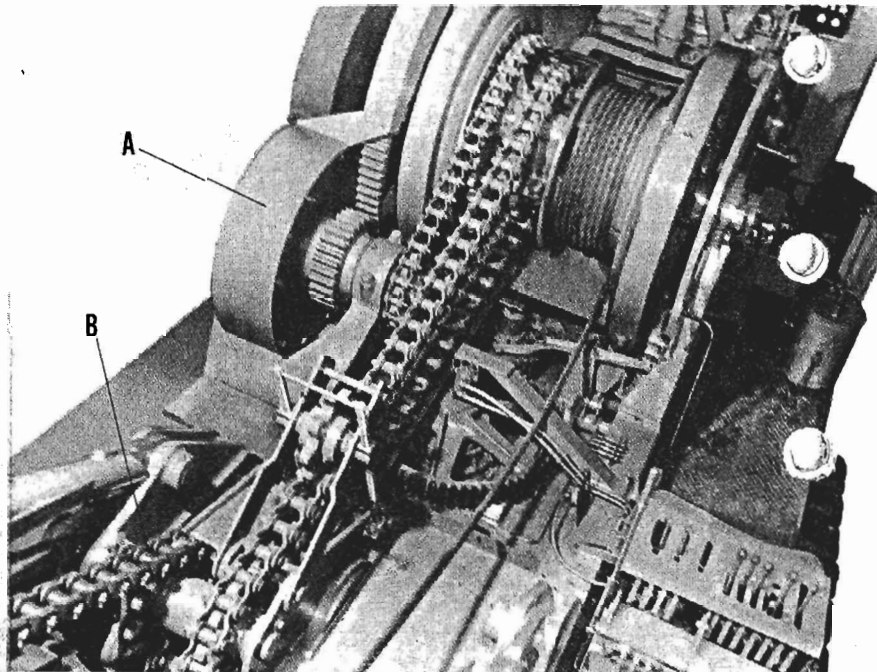



to take advantage of King-size power

RETRACT UNIT—Retract unit ("A" in photo at left) which is located ahead of and driven by main drum gear, is quick acting and positive, controlled by same short throw lever as the crowd. Operator thus has one-hand control of crowding and retracting the dipper.

Twin sprocket ("B" in photo at left) is located in line with boom foot hinge pins. No chain adjustment is required when changing boom angle. In the normal position the sprocket position provides maximum crowding effort for those tough jobs. By turning the sprocket end-for-end the crowding and retracting speed can be increased 20% when maximum crowding effort is not required and higher speed for lighter digging is desirable.



combines brute strength with needle-threading precision

Whether you're using a hook block, sling, clamshell, magnet, grapple or any similar attachment—the K-608 Series crane provides distinct advantages over other rigs. The upper section of this 60 foot basic boom has an open throat design for close radius hoisting without cable-boom interference. 5, 10, 20, and 30 foot boom sections are available for rated lengths up to 150 feet. It's sturdy, stable and able. Speed-o-Matic power hydraulic controls provide perfect feel, plus pin-point precision.

Other important optional features include:

- Operator's catwalk
- Rigid boom backstop
- Independent boomhoist.
- Pin-connected boom
- High capacity 20-40 foot jib
- Extender cable arrangement
- Elevated cab
- High capacity 3rd drum

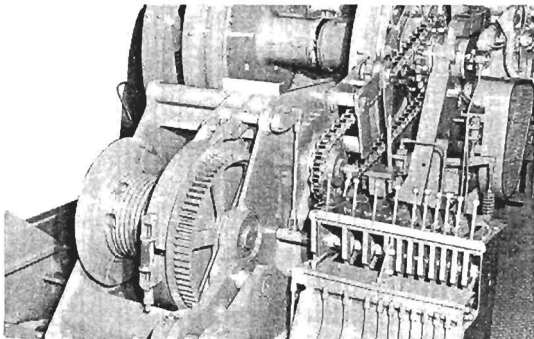

HIGH-CAPACITY THIRD DRUM — this feature is particularly valuable for pile driving and for operations that require "snaking in" a load. High in speed and line capacity . . . it's completely independent of all other machine functions.

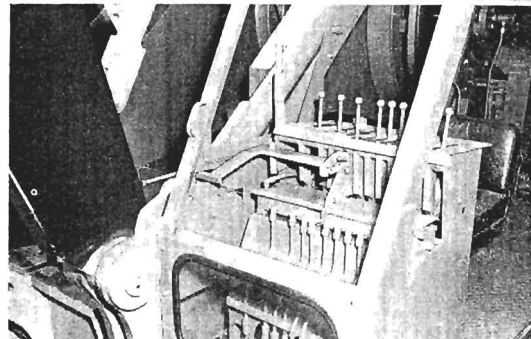

BOOMHOIST LEVER KICK-OUT is available on K-608 Series cranes equipped with independent rapid boomhoist for safe, close radius booming. The possibility of booming up beyond the danger point is eliminated.

TRIPLE SHEAVE ARRANGEMENT, optional, allows multiple-reaving of hoist line between boompoint and hook block. Roller type cable guards are standard for single, double or triple boompoint sheave arrangement. Roller guards and boompoint sheaves are mounted on anti-friction bearings.

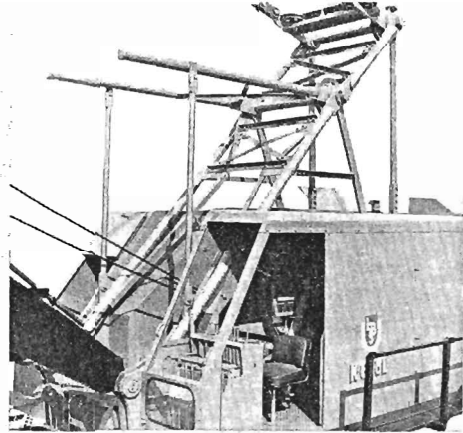
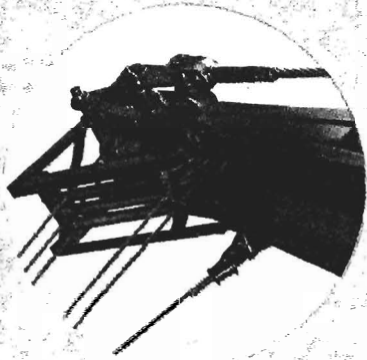

FIXED HIGH GANTRY — Standard — for crane, clamshell and dragline operations.

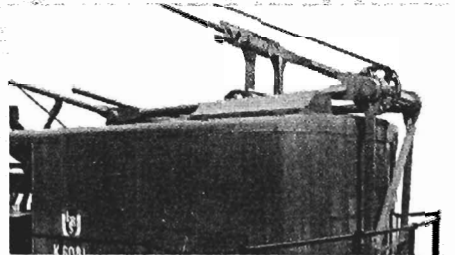

RETRACTABLE HIGH GANTRY — optional — can be raised or lowered under power in seconds.

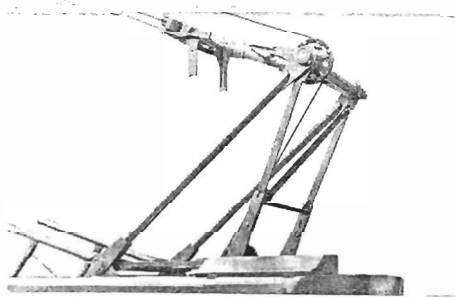

BUTT CONNECTIONS are precision machined so that loadings are transmitted down chord angles equally from boom section to boom section.

HYDRAULIC SWING BRAKE — A Speed-o-Matic actuator swing brake is available in addition to standard swing lock and particularly valuable on erection jobs. This brake holds the upper securely in the desired position, prevents drift and acts as drag to prevent overswing.

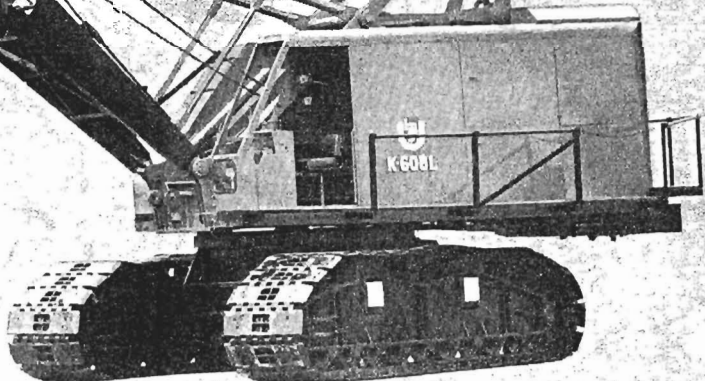
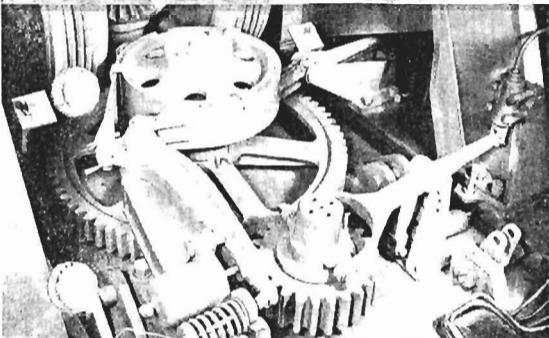

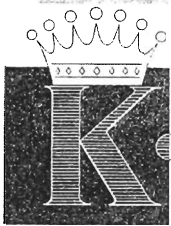

K-608 series / dragline



long reach, big line pull, fast cycles

With K-608 Series draglines, you get a two-way step-up in production. First, with bonus horsepower and exceptional maneuverability—you speed cycles. Second, with extra strength plus easy accessibility for maintenance—the K-608 Series spends more time in actual productive effort.

What's more, there is plenty of stability plus excellent flotation (with either the 7-roller K-608 or the 9-roller K-608L lowers).

Check this partial list of dragline features

- Dragline boom has capacities equal to those of lifting crane booms for added versatility.
- Extender cables (optional) facilitate insertion or removal of boom extensions without disturbing boomhoist cable reeving.
- Free-spooling drums on anti-friction bearings permit bucket casting with no drag.
- Anti-friction bearings for boom peak sheaves require only bi-monthly instead of daily greasing.
- Choice of laggings helps tailor the machine to the job.
- Fixed high gantry is standard.

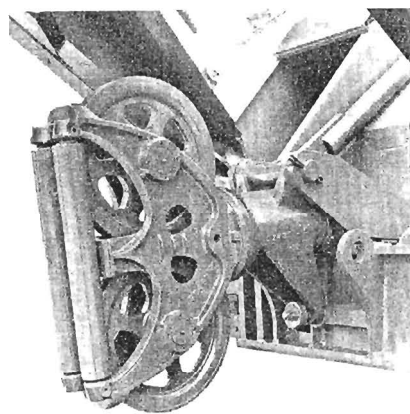

FULL-REVOLVING FAIRLEADER ASSURES LONGER CABLE LIFE.

Fairleader is equipped with anti-friction bearings in the barrel, sleeves and front guide rollers. Unit is designed to adjust itself automatically to the inhaul cable pull, insuring full cable support. This eliminates excessive cable bending. Front guide rollers, rather than conventional rub plates, eliminate excessive cable rubbing and crimping.

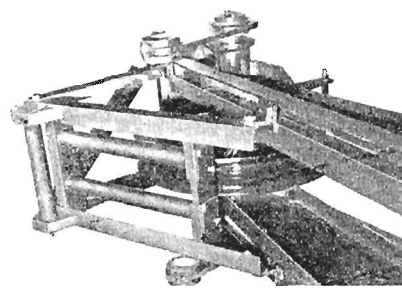

WIDE-MOUTH SINGLE BOOMPOINT SHEAVE

is specially designed for dragline, demolition and similar operation. It provides broad deep seat for cable when load line is off-lead to the boom.

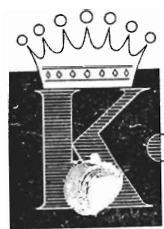

608 series / hoe

the weight to bite

--the power to pull

Answers the need for an agile, mobile . . . more powerful, deeper-digging . . . big capacity hoe

Here's a 3-yard hoe that will pay handsome dividends on those deep trenching or excavation jobs. Link-Belt Speeder engineers have provided a perfect combination of weight in boom, arm and pitch brace, with bonus usable horsepower to hoist and swing simultaneously. Result—easy deep-digging, faster inhaul and more positive side-casts.

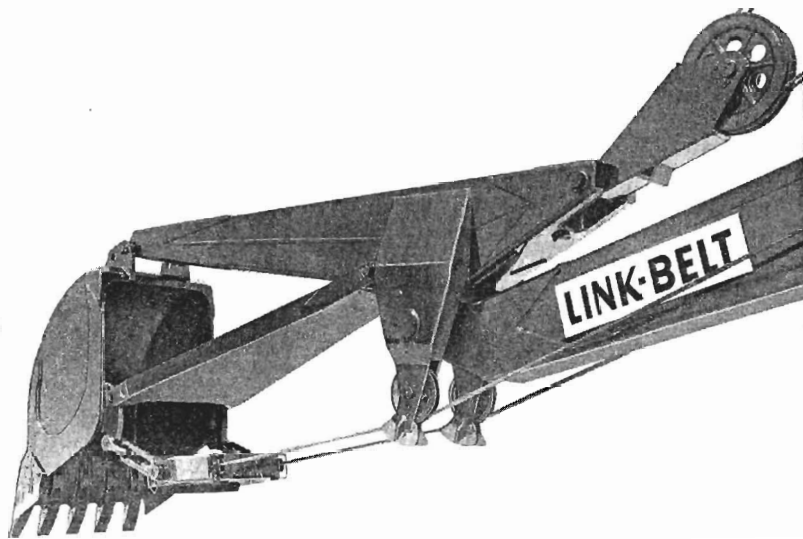
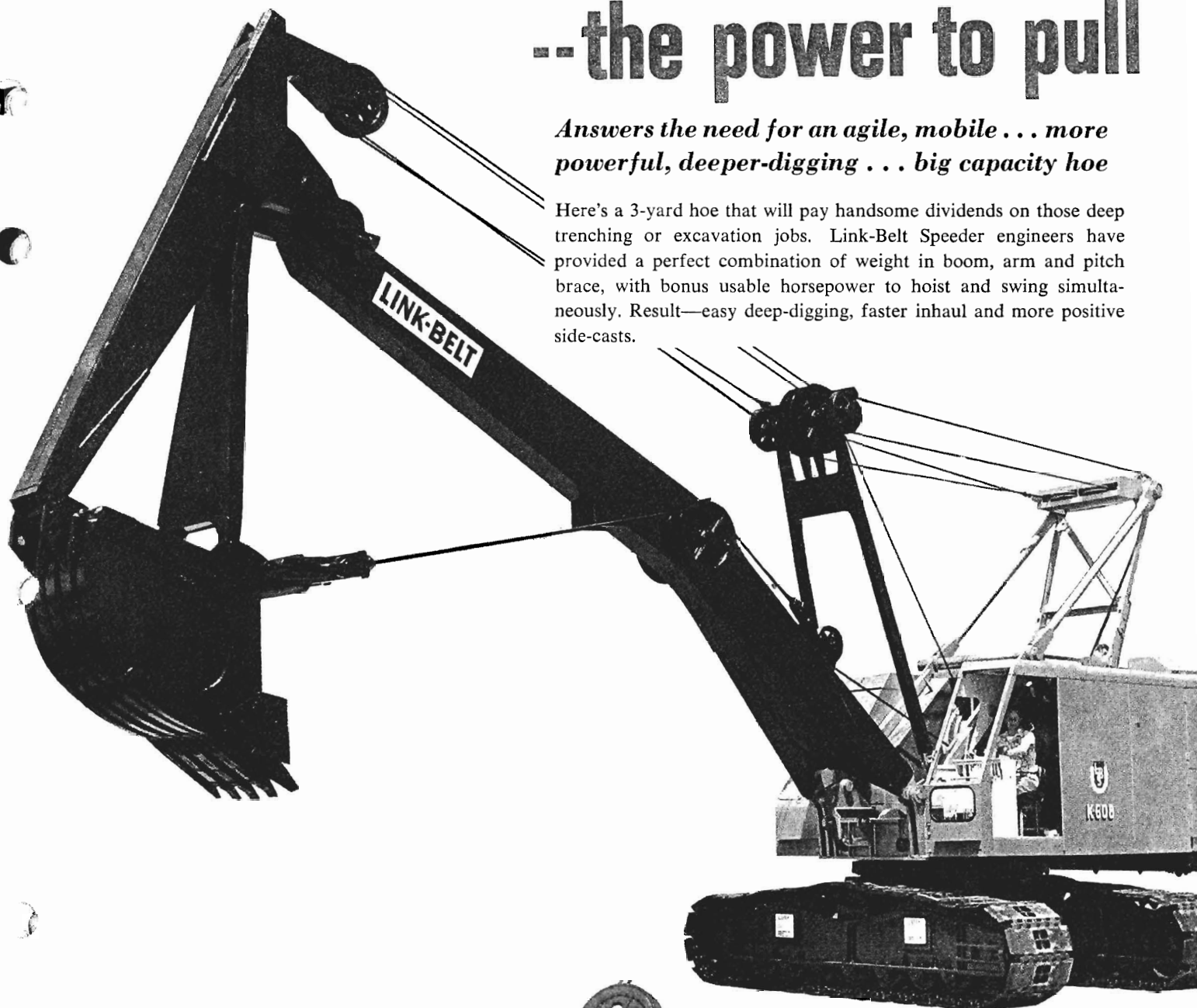

MASSIVE BOX SECTION ARM—with adjustable connection to rear of bucket. High arch pitch brace does not interfere with bucket fill. 3-yard hoe bucket is designed with recessed lugs for operation with, or without, side cutters. Two-piece heat-treated bucket teeth with replaceable points.

Bucket padlock sheave fully enclosed. Replaceable hardened steel cable guides.

Extra-wide, arm-mounted cable guides lead cable into deflector sheaves which deflect the inhaul cable when the arm is in an extended position.

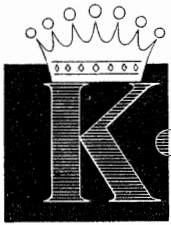

608 series / shovel-cranes

*Move up to King-size
profit with the
King-size K-608*

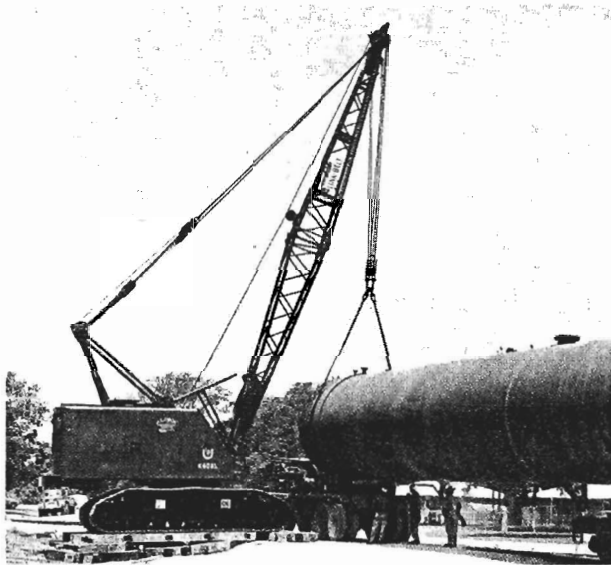
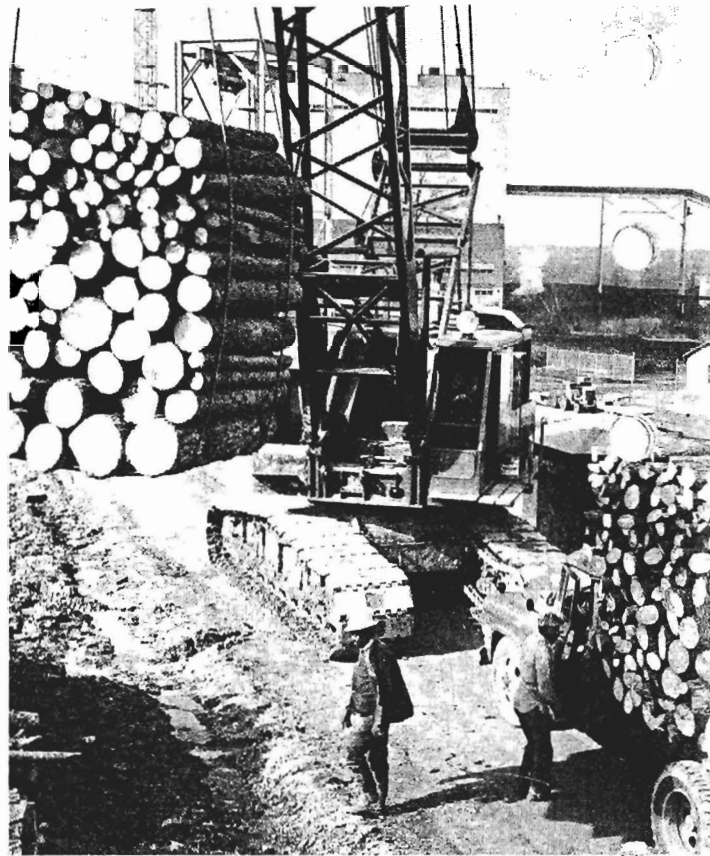
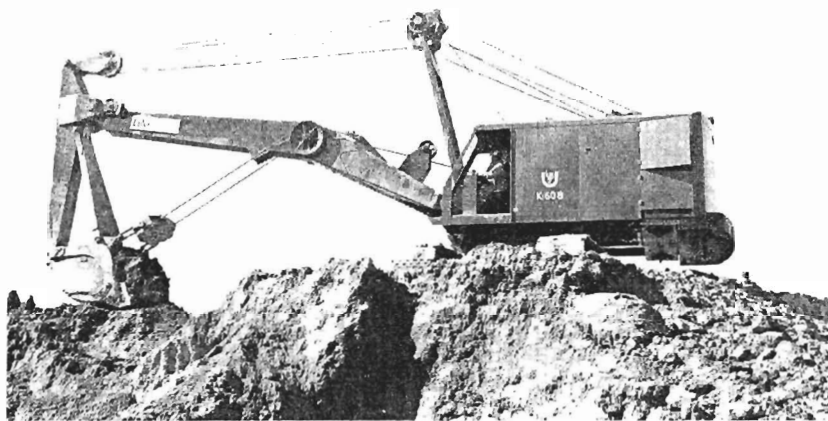

LINK-BELT SPEEDER

Link-Belt Speeder Corporation
Cedar Rapids, Iowa

Link-Belt Speeder (Canada) Ltd.
Woodstock, Ontario

A complete line of rubber-tired and crawler-mounted shovel-cranes— $\frac{1}{2}$ to 3-yd., 8 to 75-ton capacities, and three models of diesel pile hammers.

