



MAC 25-4
25 Tonne Lifting Capacity
Pick & Carry Crane
Datasheet
Metric

MAC 25-4



Features: MAC 25-4

- ▶ 25 tonne at 1.41 m radius
- ▶ 1.8 tonne at 15.71 m radius
- ▶ 18 m maximum hook height
- ▶ Hook block (6 parts) capacity 25 tonne
- ▶ Single line 4.2 tonne

WORKS FOR YOU.™

Key

..... 3

Dimensions

Crane dimensions 4, 5
Range diagram 6
Area of operation 7

Load charts

Fallblock, Front counterweight
 Third boom retracted 8
 Third boom extending 9
Fallblock, Rear counterweight
 Third boom retracted 10
 Third boom extending 11

Technical description

Boom and Jib 12
Winch 12
Engine and transmission 12
Hydraulic system 13
Chassis 13
Tyres 13
Vehicle performance 14
Cab, controls, and operator aids 14

	Boom length		Speed
	Hook height		Slewing / Allowable slewing range
	Boom with jib		Crane / Crane in standard configuration
	Telescoping mode		Gradeability
	Boom elevation angle		Gross vehicle weight
	Working radius		Counterweight on front
	Hook and block		Counterweight on rear
	On rubber		Controls
	Main winch		Cab
	Winch speed		Air conditioning / Cab heating
	Engine		Operator aids / Load limiter / Load indicator
	Transmission		Rope – Standard / Optional
	Hydraulics		Rope diameter
	Steering		Rope length
	Tyres		Maximum line pull

DIMENSIONS

MAC 25-4

Crane Dimensions

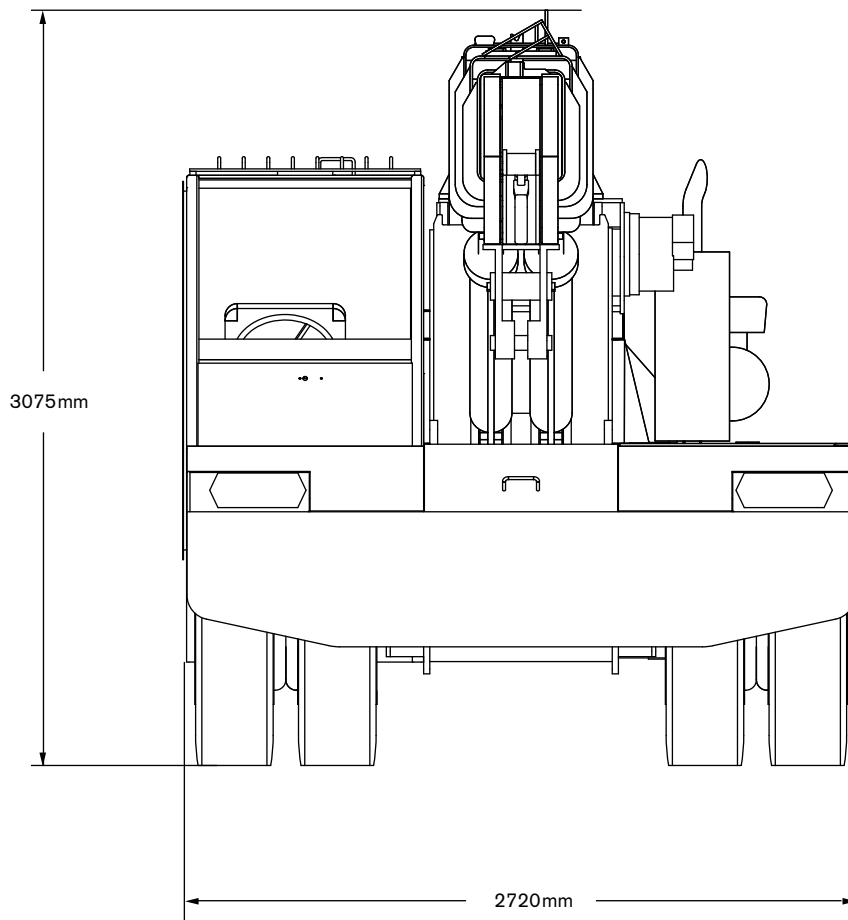

RADIUS LOAD CHART

MAC 25-4

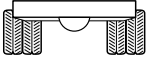

Pick & Carry 0.4 m/s (1.44 km/h); On rubber 66.6%

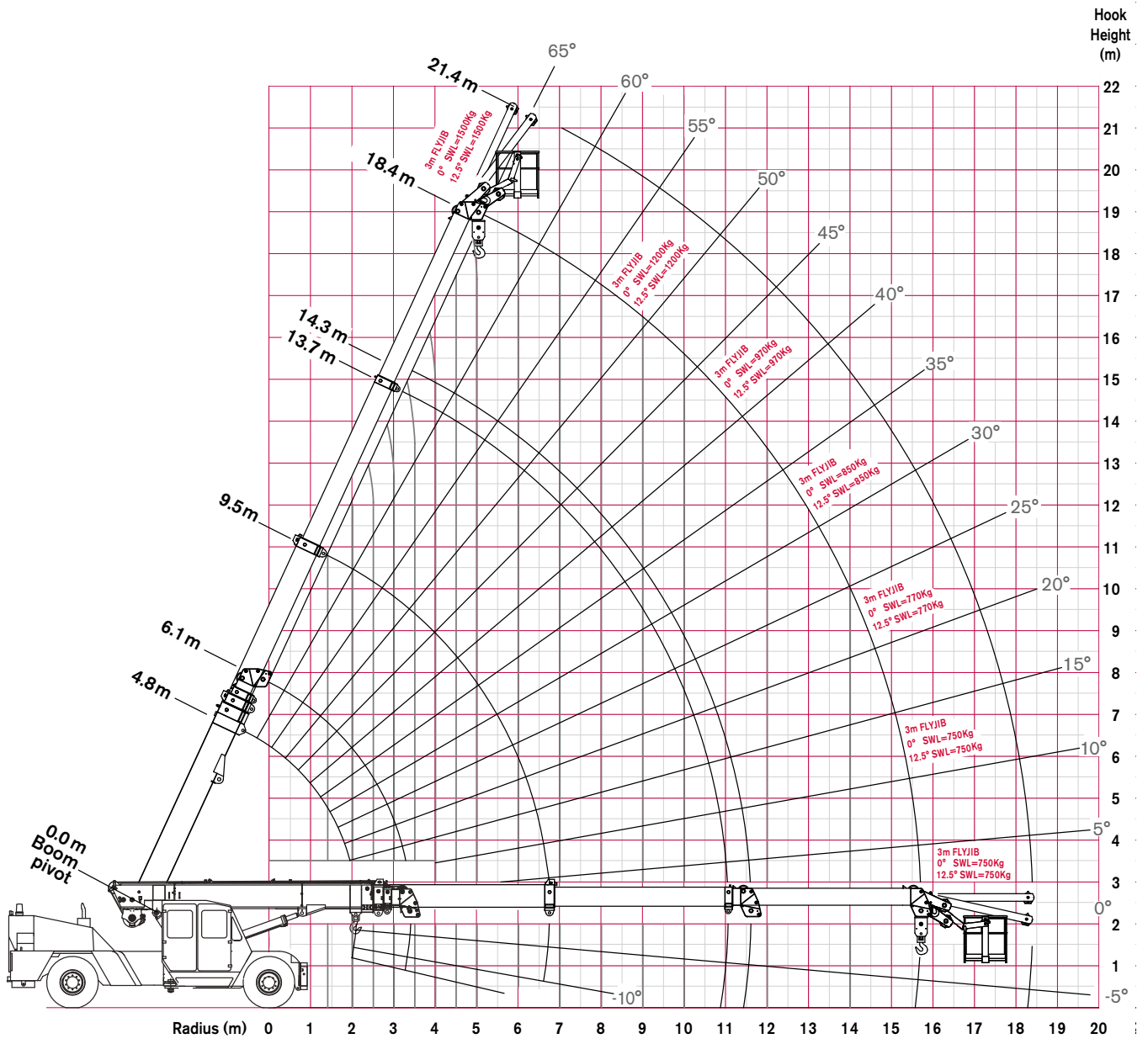

Radius (m)	0	1	2	3	4	5	6	7	8	9	10	11	12	13	14	15	16	17	18	19	20	
SWL (tonnes) 0° ARTIC	25	23	18.1	14.8	12.5	11.1	9.7	7.6	6.1	5.1	4.3	3.6	2.7	2.2	1.8							
SWL (tonnes) 40° ARTIC	25	20	16.2	13.2	11.1	9.9	8.6	6.7	5.4	4.4	3.7	3.1	2.3	1.9	1.5							

AREA OF OPERATION

MAC 25-4

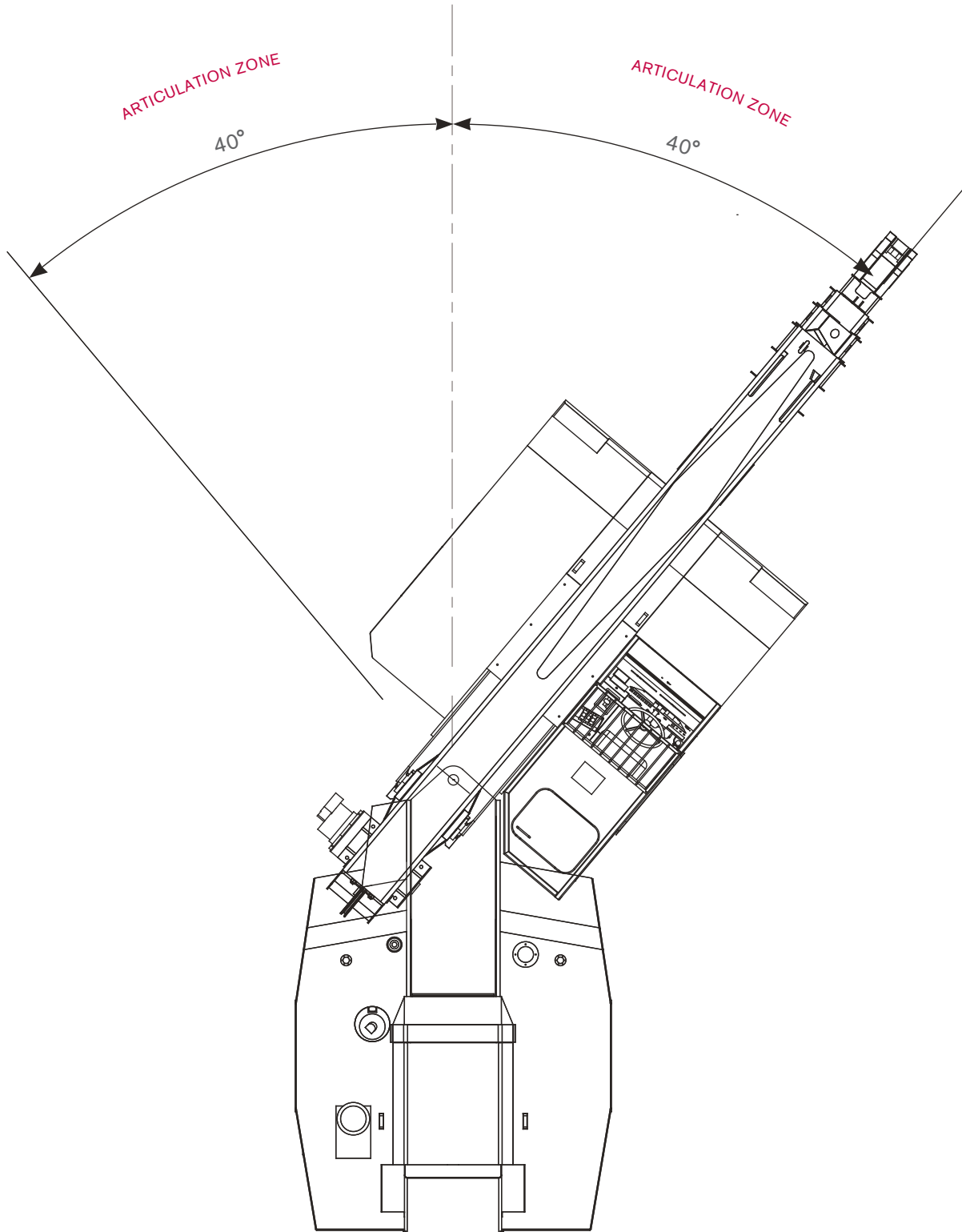

LOAD CHART

MAC 25-4

Fallblock, Front Counterweight, 3rd Boom Retracted

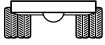

Pick & Carry 0.4 m/s (1.44 km/h); On rubber 66.6%



6.1–14.0 m

AS 1418.5

		Boom Length (m)														
		6.1	6.5	7.0	7.5	8.0	8.5	9.0	9.5	10.0	11.0	12.0	13.0			14.0
m	kg	kg	kg	kg	kg	kg	kg	kg	kg	kg	kg	kg	kg	kg	m	
1.4	24000	23950	23950	23950	23900	23900	23550								1.4	
	23450	23450	23400	23400	23400	23350	23350									
	49°	52°	56°	58°	61°	63°	65°									
2.0	20100	20050	20050	20000	19950	19950	19900	19850	19850						2.0	
	18050	18000	17950	17900	17900	17850	17850	17800	17800							
	41°	45°	49°	52°	55°	58°	60°	62°	64°							
2.5	15800	15750	15750	15700	15700	15650	15650	15600	15600	15550					2.5	
	15100	15100	15050	15050	15000	15000	14950	14950	14900	14900						
	14150	14100	14100	14050	14050	14000	14000	13950	13950	13900						
3.0	12900	12900	12850	12850	12850	12800	12800	12750	12750	12700	12700				3.0	
	12350	12350	12300	12300	12300	12250	12250	12200	12200	12150	12150					
	11500	11500	11500	11450	11450	11450	11400	11400	11350	11350	11300					
3.5	10850	10800	10800	10800	10800	10750	10750	10750	10700	10700	10650	10650			3.5	
	10350	10350	10350	10350	10300	10300	10300	10250	10250	10200	10200	10200				
	9650	9650	9650	9600	9600	9600	9550	9550	9550	9500	9500	9100				
4.0	(3.5)	19°	28°	35°	40°	44°	47°	50°	53°	57°	61°	63°			4.0	
	9600	9250	9250	9250	9250	9250	9250	9200	9200	9150	9150	9150	9100			
	9200	8850	8850	8850	8850	8850	8800	8800	8800	8750	8750	8700	8700			
5.0		8300	7300	7100	7100	7100	7050	7050	7050	7000	7000	7000	7000		5.0	
		7950	6950	6750	6750	6750	6750	6750	6750	6700	6700	6700	6650			
		7350	6450	6250	6250	6250	6250	6250	6250	6200	6200	6200	6050			
6.0		(4.4)	(4.9)	17°	26°	32°	37°	40°	46°	51°	55°	58°			6.0	
					6450	5750	5650	5650	5650	5600	5600	5600	5600			
					6150	5500	5350	5350	5350	5350	5350	5300	5300			
7.0					5700	5050	4950	4950	4950	4900	4900	4900	4900		7.0	
					(5.4)	(5.9)	16°	24°	30°	38°	44°	49°	53°			
								5200	4700	4600	4600	4600	4600	4550		
8.0								4950	4450	4350	4350	4350	4350	4350	8.0	
								4550	4100	4000	4000	4000	4000	3950		
								(6.4)	(6.9)	15°	29°	37°	42°	47°		
9.0										4250	3800	3800	3800	3800	9.0	
										4050	3600	3600	3600	3600		
										3700	3300	3300	3300	3300		
10										(7.4)	14°	27°	35°	41°	10	
											3550	3200	3200	3200		
											3350	3050	3050	3000		
11												3050	2750	2750	11	
												(8.4)	14°	26°		34°
													3000	2750		2750
12													2850	2550	12	
													2550	2300		2300
													(9.4)	13°		25°
													2550	2350	12	
													2400	2200		
													2150	1950		
													(10.4)	13°		
														2200	12	
														2050		
														1850		
														(11.4)		

- RC (kg) at 0° articulation
- RC (kg) at 25° articulation
- RC (kg) at 40° articulation
- Boom angle
- Radius at 0° boom angle
- Loads above red line are structural

Notes to lifting capacity

Lifting capacities do not exceed 66.6% of tipping load. Weight of hook blocks and slings is part of the load, and is to be deducted from the capacity ratings. Consult Rated Capacity Manual for further details.

Data published herein is intended as a guide only and shall not be construed to warrant applicability for lifting purposes. Crane operation is subject to the computer charts and Rated Capacity Manual both supplied with the crane.

LOAD CHART

MAC 25-4

Fallblock, Front Counterweight, 3rd Boom Extending

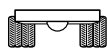

Pick & Carry 0.4 m/s (1.44 km/h);
On rubber 66.6%



15.0–18.42 m

AS 1418.5

m	Boom Length (m)				m
	15.0	16.0	17.0	18.4	
kg	kg	kg	kg	kg	m
1.4					1.4
2.0					2.0
2.5					2.5
3.0					3.0
3.5					3.5
4.0					4.0
5.0	7050 6750 5800 61°	7150 6800 5500 63°	7250 6900 5350 65°		5.0
6.0	5650 5350 4850 56°	5700 5450 4700 59°	5800 5500 4550 61°	5900 5600 4350 64°	6.0
7.0	4600 4400 4050 51°	4700 4450 4050 54°	4800 4550 3950 57°	4850 4650 3800 60°	7.0
8.0	3850 3650 3350 45°	3950 3750 3450 49°	4000 3800 3450 52°	4100 3900 3350 56°	8.0
9.0	3250 3100 2800 39°	3350 3150 2900 44°	3400 3250 2950 47°	3500 3300 2950 52°	9.0
10	2800 2600 2400 33°	2850 2700 2450 38°	2950 2750 2500 42°	3000 2850 2600 47°	10
11	2400 2250 2000 24°	2500 2350 2100 32°	2550 2400 2150 37°	2650 2500 2250 43°	11
12	2050 1900 1700 12°	2150 2000 1800 24°	2200 2100 1850 31°	2300 2150 1950 38°	12
13	1950 1800 1600 (12.4)	1850 1750 1550 12°	1950 1800 1600 23°	2000 1900 1700 32°	13
14		1750 1450 (13.4)	1700 1400 12°	1800 1500 25°	14
15			1600 1300 (14.4)	1550 1300 17°	15
15.71				1400 1150 (15.8)	15.71

- RC (kg) at 0° articulation
- RC (kg) at 25° articulation
- RC (kg) at 40° articulation
- Boom angle
- Radius at 0° boom angle
- Loads above red line are structural

Notes to lifting capacity

Lifting capacities do not exceed 66.6% of tipping load. Weight of hook blocks and slings is part of the load, and is to be deducted from the capacity ratings. Consult Rated Capacity Manual for further details. Data published herein is intended as a guide only and shall not be construed to warrant applicability for lifting purposes. Crane operation is subject to the computer charts and Rated Capacity Manual both supplied with the crane.

LOAD CHART

MAC 25-4

Fallblock, Rear Counterweight, Third Boom Retracted

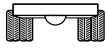

Pick & Carry 0.4 m/s (1.44 km/h); On rubber 66.6%



6.1–14.0 m

AS 1418.5

		Boom Length (m)													
		6.1	6.5	7.0	7.5	8.0	8.5	9.0	9.5	10.0	11.0	12.0	13.0		
m	kg	kg	kg	kg	kg	kg	kg	kg	kg	kg	kg	kg	kg	kg	m
1.4	25000	25000	25000	2500	24500	23950	23550								1.4
	24800	24800	24800	24750	24550	24000	23600								
	49°	52°	56°	58°	61°	63°	65°								
2.0	22950	22950	22900	22900	22850	22800	22800	22750	22750						2.0
	20550	20550	20500	20450	20450	20400	20350	20350	20300						
	41°	45°	49°	52°	55°	58°	60°	62°	64°						
2.5	18100	18100	18050	18000	18000	17950	17950	17900	17900	17850					2.5
	17300	17300	17250	17250	17200	17200	17150	17150	17150	17100					
	16150	16150	16100	16100	16050	16050	16000	16000	15950	15100					
3.0	14800	14800	14800	14800	14750	14750	14700	14700	14700	14650	14550				3.0
	14200	14150	14150	14150	14100	14100	14050	14050	14050	14000	13450				
	13200	13200	13200	13150	13150	13100	13100	13100	13050	12650	11450				
3.5	12500	12450	12450	12450	12450	12400	12400	12400	12350	12350	12300	12300			3.5
	11950	11900	11900	11900	11900	11850	11850	11850	11800	11800	11750	11600			
	11100	11100	11100	11050	11050	11050	11000	11000	11000	10850	9900	9100			
4.0		11100	10700	10700	10700	10700	10650	10650	10650	10600	10600	10600	10550		4.0
		10600	10200	10200	10200	10200	10200	10150	10150	10150	10100	10100	10100		
		9850	9500	9500	9500	9500	9450	9450	9450	9400	8750	8050	9400		
5.0			9650	8500	8250	8250	8250	8250	8200	8200	8200	8150	8150		5.0
			9200	8100	7850	7850	7850	7850	7850	7800	7800	7800	7750		
			8500	7500	7250	7250	7250	7250	7250	7250	7050	6500	6100		
6.0					7550	6750	6600	6600	6600	6600	6550	6550	6550		6.0
					7200	6450	6250	6250	6250	6250	6250	6250	6200		
					6650	5950	5800	5800	5800	5800	5750	5450	5100		
7.0							6100	5550	5400	5400	5400	5400	5400		7.0
							5800	5250	5150	5150	5150	5100	5100		
							5350	4850	4750	4750	4700	4700	4350		
8.0									5050	4550	4550	4550	4550		8.0
									4800	4300	4300	4300	4300		
									4400	3950	3950	3950	3850		
9.0										4250	3850	3850	3850		9.0
										4000	3650	3650	3650		
										3650	3300	3300	3300		
10											3600	3300	3300		10
											3400	3100	3100		
											3100	2800	2800		
11												3100	2850		11
												2950	2700		
												2650	2400		
12													2700		12
													2550		
													2250		

- RC (kg) at 0° articulation
- RC (kg) at 25° articulation
- RC (kg) at 40° articulation
- Boom angle
- Radius at 0° boom angle
- Loads above red line are structural

Notes to lifting capacity

Lifting capacities do not exceed 66.6% of tipping load. Weight of hook blocks and slings is part of the load, and is to be deducted from the capacity ratings. Consult Rated Capacity Manual for further details.

Data published herein is intended as a guide only and shall not be construed to warrant applicability for lifting purposes. Crane operation is subject to the computer charts and Rated Capacity Manual both supplied with the crane.

LOAD CHART

MAC 25-4

Fallblock, Rear Counterweight, Third Boom Extending

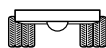

Pick & Carry 0.4 m/s (1.44 km/h);
On rubber 66.6%



15.0–18.42 m

AS 1418.5

m	Boom Length (m)				m
	15.0	16.0	17.0	18.4	
kg	kg	kg	kg	kg	m
1.4					1.4
2.0					2.0
2.5					2.5
3.0					3.0
3.5					3.5
4.0					4.0
5.0	8200 7850 5800 61°	8300 7900 5600 63°	8400 7950 5400 65°		5.0
6.0	6600 6300 4850 56°	6700 6350 4700 59°	6750 6450 4550 61°	6850 6400 4400 64°	6.0
7.0	5450 5150 4200 51°	5550 5250 4050 54°	5600 5350 3950 57°	5700 5400 3800 60°	7.0
8.0	4600 4350 3650 45°	4650 4400 3550 49°	4750 4500 3450 52°	4800 4600 3350 56°	8.0
9.0	3900 3700 3250 39°	4000 3750 3150 44°	4050 3850 3050 47°	4150 3950 2950 52°	9.0
10	3350 3150 2900 33°	3450 3250 2850 38°	3500 3300 2750 42°	3600 3400 2650 47°	10
11	2900 2750 2500 24°	3000 2850 2550 32°	3050 2900 2500 37°	3150 3000 2400 43°	11
12	2550 2400 2150 12°	2650 2450 2200 24°	2700 2550 2300 31°	2800 2600 2200 38°	12
13	2400 2250 2000 (12.4)	2300 2150 1950 12°	2400 2250 2000 23°	2450 2300 2050 32°	13
14		2200 1850 (13.4)	2100 1750 12°	2200 1850 25°	14
15			2000 1650 (14.4)	1950 1650 17°	15
15.71				1800 1450 (15.8)	15.71

- RC (kg) at 0° articulation
- RC (kg) at 25° articulation
- RC (kg) at 40° articulation
- Boom angle
- Radius at 0° boom angle
- Loads above red line are structural

Notes to lifting capacity

Lifting capacities do not exceed 66.6% of tipping load.

Weight of hook blocks and slings is part of the load, and is to be deducted from the capacity ratings.



Consult Rated Capacity Manual for further details.

Data published herein is intended as a guide only and shall not be construed to warrant applicability for lifting purposes. Crane operation is subject to the computer charts and Rated Capacity Manual both supplied with the crane.



Boom and Jib

	Four section boom: Main boom and three powered sections	
	Maximum hook height	18 m
	Boom elevation angle range (min. / max.)	-10° / 65°
	Maximum hook height with jib	22 m
	40° articulation each side of centre providing a total 80° slewing arc	80°
	Machinery hook	15 tonne

Winch

	Winch: Fully compensated hook height when telescoping boom 1 and 2 Anti two-block system	
	Maximum line pull	4.2 tonne
	Two speed winch	41 m/min / 82 m/min
	Hook block, two, four, or six part, maximum rated capacity	25 tonne





Engine and Transmission

	Mercedes OM 906 EUROMOT 3a turbo charged and intercooled diesel engine with hinged engine cover and mid cover for easy serviceability	205 kW
	Engine torque	1100 Nm
	Fuel capacity	440 l
	Fuel type	diesel
	Allison 3000	6-speed automatic
	Transfer Case: Styer VG 750 2:1 ratio High/low range via airshift 2WD/4WD via airshift, disconnect to rear axle	

Hydraulic System

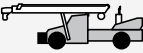
	Hydraulic Pump: Load sensing axial piston Maximum pump flow rate Maximum working pressure	150 litre/min 250 bar
	Hydraulic tank with top mounted return and in-tank suction filters	380 l

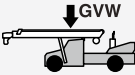
Chassis

	Drive axles: Kessler D71 PL477 heavy duty high speed planetary axle Front axle fitted with driver selectable diff lock and reinforced for pick and carry operation	
	Removable counterweight on front: Front axle Rear axle	11,900 kg 12,000 kg
	Removable counterweight on rear: Front axle Rear axle	9,900 kg 14,000 kg
	Total:	23,900 kg
	Full power Orbitrol with twin hydraulic double acting rams Priority flow from main pump supply plus electro-hydraulic emergency supply Turning Circle: Outside wheels radius	7.9 m
	Brakes: Air operated high capacity Large wedge style twin circuit service and spring applied park brakes on both front and rear axles Crane operation hold brake on right side front wheel Driver selectable engine exhaust brake is available in all gears - automatically selects converter lockup	
	Suspension: Two semi-elliptic springs on front and rear axle with automatic hydraulic spring lockouts on front axle	



Tyres

	14.00 x 20 bias ply duals 20 in x 10 in heavy duty ISO 10 stud 335 PCD spigot mount rims
---	---

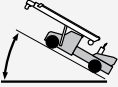
Vehicle performance

	Maximum rated travel speed	75 kph
	Gradeability	45%

Cab, Controls, and Operator aids

	Two person, insulated lock up cabin: <ul style="list-style-type: none">ISRI Suspension driver's and passenger seats, including retracting seat beltsColour LCD displayMP3 player with integrated GPS with Bluetooth handsfreeReversing cameraCentralised greasingCruise controlEngine monitoringService diagnostics
	Dynamic calculating rated capacity indicator with audio/visual overload pre-warning and motion cut-outs
	3 pilot control levers for crane functions
	Air conditioned and heated

BRISBANE

585 Curtin Avenue East
Eagle Farm QLD 4009
AUSTRALIA

Ph: +61 7 3868 9600
Fax: +61 7 3268 2489

MELBOURNE

187 Osborne Avenue
Clayton South VIC 3169
AUSTRALIA

Ph: +61 3 9551 8644
Fax: +61 3 9551 8143

SYDNEY

114 Hassall Street
Wetherill Park NSW 2164
AUSTRALIA

Ph: +61 2 8786 4444
Fax: +61 2 8786 4455

PERTH

39 Catalano Road
Canning Vale WA 6155
AUSTRALIA

Ph: +61 8 9232 0000
Fax: +61 8 9232 0051

Effective Date: July 2014. Product specifications and prices are subject to change without notice or obligation. The photographs and/or drawings in this document are for illustrative purposes only. Refer to the appropriate Operator's Manual for instructions on the proper use of this equipment. Failure to follow the appropriate Operator's Manual when using our equipment or to otherwise act irresponsibly may result in serious injury or death. The only warranty applicable to our equipment is the standard written warranty applicable to the particular product and sale and Terex makes no other warranty, express or implied. Products and services listed may be trademarks, service marks or trade-names of Terex Corporation and/or its subsidiaries in the USA and other countries. All rights are reserved. Terex® is a registered trademark of Terex Corporation in the USA and many other countries. Copyright 2014 Terex Corporation.

Terex Cranes, Global Marketing, Dinglerstraße 24, 66482 Zweibrücken, Germany
Tel. +49 (0) 6332 830, Email: info.cranes@terex.com, www.terexcranes.com



www.terexcranes.com

Brochure Reference: TC-DS-M-E-MAC25-4-07/14



WORKS FOR YOU.™