

Operator's Manual

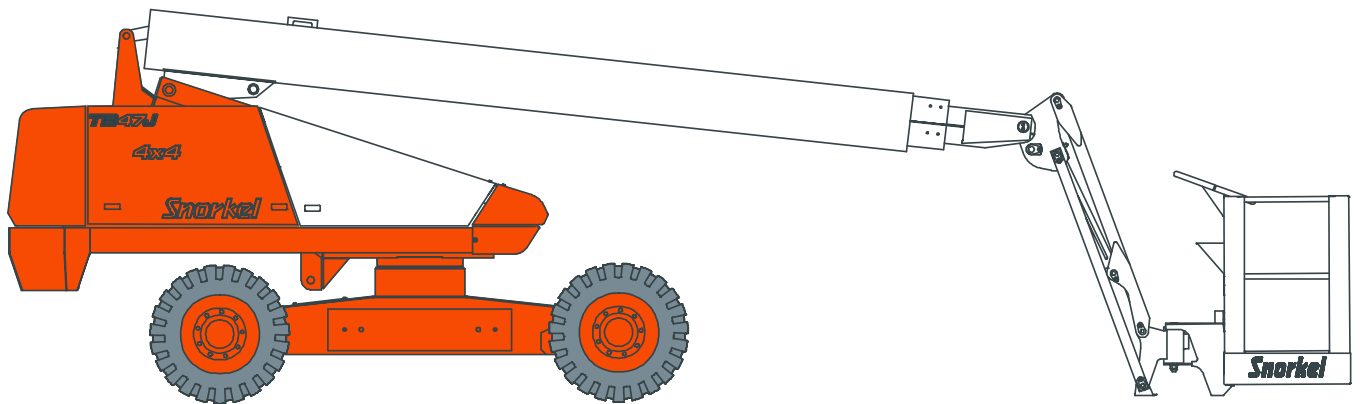

TB47J

Part Number 0075239EE
July, 2005

CE

Snorkel
INTERNATIONAL

DANGER

The aerial platform is not electrically insulated. Death or serious injury will result from contact with, or inadequate clearance from, an energized conductor.

Do not go closer than the minimum safe approach distance as defined by the Minimum Safe Approach Distance section in Chapter 3 – Safety.

Regard all conductors as energized.

Allow for electrical wire sag and aerial platform sway.

If the platform, booms, or any part of the aerial platform contacts a high-voltage electrical conductor, the entire machine can become electrically charged.

If that happens, remain on the machine and do not contact any other structure or object. This includes the ground, adjacent buildings, poles, and any other objects that are not part of the aerial platform.

Such contact could make your body a conductor to the other object, creating an electrical shock hazard resulting in death or serious injury.

If an aerial platform is in contact with an energized conductor the platform operator must warn ground personnel in the vicinity to stay away. Their bodies can conduct electricity creating an electrical shock hazard resulting in death or serious injury.

Do not approach or leave the aerial platform until the electricity has been turned off.

Do not attempt to operate the lower controls when the platform, booms, or any part of the aerial platform is in contact with a high-voltage electrical conductor or if there is an immediate danger of such contact.

Personnel on or near an aerial platform must be continuously aware of electrical hazards, recognizing that death or serious injury can result from contact with an energized conductor.

Table of Contents

Chapter 1 – Introduction

Aerial Platform Features	1
Options	1
Operator's Manual	1
Safety Alerts	1
Operation	1
Maintenance	2
Owner and User Responsibilities	2
Additional Information	2

Chapter 2 – Specifications

Component Identification	3
Working Envelope	4
General Specifications	5
Aerial Platform	5
Platform	5
Function Speed	5
Drive System	5
Tires	5
Electrical System	5
Hydraulic System	5
Engine	5
Fuel Tank Capacity	5
Ambient Air Temperature Operating Range	5
Maximum Wind Speed	5
Engine Specifications	6
Engine Oil Viscosity	7
Cummins B3.3	7
Deutz F3L-2011F	7

Chapter 3 – Safety

Electrocution Hazards	9
Minimum Safe Approach Distance	9
Prestart Inspection	10
Work Place Inspection and Practices	10
Operation	10
Tip-Over and Falling Hazards	10
Electrical System	11
Hydraulic System	11
Engine and Fuel Handling Precautions	11
Placards and Decals	12

Chapter 4 – Safety Devices

Emergency Stop Controls	13
Emergency Power System	13
Emergency Lowering Knob	13
Ground Operation Switch	14
Platform Foot Switch	14
Guardrails	14
Lanyard Anchors	14
Tilt Alarm	14
Platform Overload Sensing System	15

Engine Protection Systems	15
High Engine Temperature Alarm	15
Low Oil Pressure Alarm	15
Horn	16
Drive Motion Alarm	16
Flashing Light	16
Driving Lights	16
Platform Work Lights	16

Chapter 5 – Gauges and Displays

Hour Meter	17
Engine Temperature Gauge	17
Ammeter	17
Engine Air Filter Gauge	17
Fuel	17
Engine Oil	18
Hydraulic Fluid Filter Gauge	18
Fluid Level and Temperature Gauge	18

Chapter 6 – Controls

Battery Disconnect Switch	19
Lower Controls	19
Emergency Stop Button	19
Control Selector Switch	19
Start Switch	19
Ground Operation Switch	20
Rotation Switch	20
Boom Elevation Switch	20
Boom Extend/Retract Switch	20
Jib Articulation Switch	20
Platform Level Switch	20
Platform Rotation Switch	20
Engine/Emergency Power Switch	20
Throttle Switch	20
Circuit Breaker Reset Buttons	20
Upper Controls	21
Start Switch	21
Emergency Stop Button	21
Speed Knob	21
Drive/Boom Selector Switch	22
Boom Joystick	22
Drive Joystick	22
Drive Range Switch	22
Jib Articulation Switch	22
Boom Extend/Retract Switch	22
Platform Rotate Switch	22
Platform Level Switch	22
Engine/Emergency Power Switch	22
Throttle Switch	22
Horn Button	23
Platform Foot Switch	23
Machine/Generator Switch	23
Driving and Platform Work Lights	23

Table of Contents

Chapter 7 – Prestart Inspection

Operator's Manual	25
Engine	25
Oil Level	25
Coolant	25
Radiator	26
Fuel Tank	26
Fuel Line	26
Air Filter	26
Charging System	26
Cold Weather Start Kit—Block Heater	26
Electrical System	26
Emergency Power Battery	27
Battery Fluid Level	27
Battery Terminals	27
Cables and Wiring Harness	27
Hydraulic System	27
Fluid Level	27
Fluid Filter	28
Hoses, Tubes, and Fittings	28
Tires and Wheels	28
Lower Control Station	28
Operating Controls	29
Emergency Stop	29
Emergency Power	29
Emergency Lowering	29
Level Sensor	29
Flashing Light	30
Sandblast Protection Kit	30
Structures	30
Weldments	30
Slide Pads	30
Wire Ropes	30
Fasteners	31
Upper Control Station	31
Guardrail System	31
Lanyard Anchors	32
Operating Controls	32
Emergency Stop	32
Emergency Power	32
Hom	32
Electrical Power Outlet	32
Drive Motion Alarm	32
Driving and Work Lights	32
Platform Control Cover	32
Tow Kit	32

Placards and Decals	33
Prestart Inspection Checklist	37

Chapter 8 – Operation

Cold Weather Start-Up	39
Engine Cold Weather Start Kit	39
Cummins — Block Heater	39
Deutz — Manifold Preheater	39
Hydraulic System Cold Weather Warm-Up	39
Preparing for Operation	40
Lower Controls	40
Upper Controls	40
Boom Operation	41
Platform Overload Sensing System	41
Driving and Steering	42
Drive Speeds	42
Motion Warning Alarm	43
Four Wheel Drive	43
AC Generator	43
Air Line	43
Driving Lights	43
Platform Work Lights	43

Chapter 9 – Stowing and Transporting

Stowing	45
Tucked Stow	45
Transporting	45
Driving	46
Winching	46
Hoisting	47
Securing for Transport	48

Chapter 10 – Emergency Operation

Emergency Power System	49
Lower Controls	49
Upper Controls	49
Emergency Lowering	50
Towing	50

Chapter 11 – Troubleshooting

Troubleshooting Chart	53
-----------------------------	----

Appendix A – Glossary

Limited Warranty

Chapter 1 – Introduction

Aerial Platform Features

The aerial platform is a boom-supported elevating work platform used to raise personnel, their tools, and material to the workstation. The booms are raised and lowered with hydraulic cylinders. Hydraulic motors on the drive wheels provide power to move the aerial platform.

The standard machine includes the following features.

- Proportional boom lift, swing, and drive control
- 170 degree hydraulic platform rotation
- Two safety lanyard attachments
- Manual lowering valve at chassis
- Hydraulic oil level and temperature gauges
- Lifting lugs
- Tie-down lugs
- Horn
- 3.5 degree tilt alarm
- Electronic ignition
- Hour meter
- Ammeter
- Coolant temperature gauge
- High engine temperature shut down
- Low oil pressure shut down
- Foam filled tires
- Battery operated emergency power system
- 360 degree continuous turntable rotation
- 76 cm x 152 cm (30" x 60") steel platform
- Platform gravity gate
- Platform overload sensing system
- Five year limited warranty

The machine may be powered with one of the following engines.

- Cummins B3.3 – Diesel
- Deutz F3L-2011F – Diesel

The aerial platform has been manufactured to conform to European Directive 98/37/EC and European Standard EN280.

Options

The following options may be provided on the machine.

- Platform control cover
- Platform work lights – flood lights
- Flashing light – amber
- Platform swinging gate
- Sandblast protection kit
- Driving lights – two headlights and two rear lights
- Spark arrestor muffler – Deutz engines
- Cold weather start kit Cummins – block heater
- Cold weather start kit Deutz – manifold preheater
- AC generator – hydraulic powered, 220 VAC
- Drive motion alarm
- Road tread tires
- Flotation tires
- Airline to platform
- Tow kit

- 76 cm x 234 cm (30" x 92") aluminum 226 kg (500 lb) capacity platform
- 76 cm x 152 cm (30" x 60") aluminum 272 kg (600 lb) capacity platform

Operator's Manual

This manual provides information for safe and proper operation of the aerial platform. Read and understand the information in this Operator's Manual before operating the aerial platform on the job.

Additional copies of this manual may be ordered from Snorkel. Supply the model and manual part number from the front cover to assure that the correct manual will be supplied.

All information in this manual is based on the latest product information at the time of publication. Snorkel reserves the right to make product changes at any time without obligation.

Safety Alerts

A safety alert symbol is used throughout this manual to indicate danger, warning, and caution instructions. Follow these instructions to reduce the likelihood of personal injury and property damage. The terms danger, warning, and caution indicate varying degrees of personal injury or property damage that can result if the instruction is not followed.

Danger

Indicates an imminently hazardous situation which, if not avoided, will result in death or serious injury. This signal word is to be used in the most extreme situations.

Warning

Indicates a potentially hazardous situation which, if not avoided, could result in death or serious injury.

Caution

Indicates a potentially hazardous situation which, if not avoided, may result in minor or moderate injury. It may also be used to alert against unsafe practices.

Notes

Notes are used to provide special information or helpful hints to assist in aerial platform operation, but do not indicate a hazardous situation.

Operation

The aerial platform has built-in safety features and has been factory tested for compliance with Snorkel specifications and industry standards. However, any personnel lifting aerial platform can be potentially dangerous in the hands of untrained or careless operators.

Warning

The potential for an accident increases when the aerial platform is operated by personnel who are not trained and authorized. Death or serious injury can result from such accidents. Read and understand the information in this manual and on the placards and decals on the machine before operating the aerial platform on the job.

Training is essential and must be performed by a qualified person. Become proficient in knowledge and actual operation before using the aerial platform on the job. You must be trained and authorized to perform any functions of the aerial platform. Operation of the aerial platform must be within the scope of the machine specifications.

The operator bears ultimate responsibility for following all manufacturer's instructions and warnings, regulations and safety rules of their employer and/or any state or federal law.

Maintenance

Every person who maintains, inspects, tests, or repairs the aerial platform must be qualified to do so. Following the daily prestart inspection in this Operator's Manual will help keep the aerial platform in optimum working con-

dition. Other maintenance functions must be performed by maintenance personnel who are qualified to work on the aerial platform.

Do not modify this aerial platform without prior written consent of the Snorkel Engineering Department. Modification may void the warranty, adversely affect stability, or affect the operational characteristics of the aerial platform.

Owner and User Responsibilities

All owners and users of the aerial platform must read, understand, and comply with all applicable regulations. Ultimate compliance to national safety regulations is the responsibility of the user and their employer.

Additional Information

For additional information contact your local dealer or Snorkel at:

Snorkel International
P.O. Box 1160
St. Joseph, MO 64502-1160 USA
785-989-3000

<http://www.snorkelusa.com>

Chapter 2 – Specifications

Component Identification

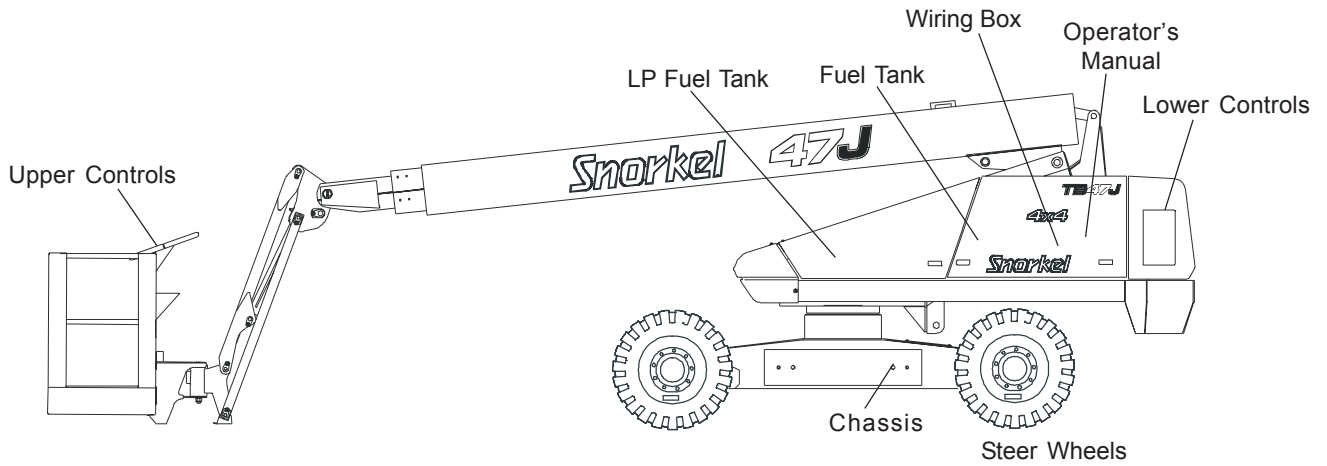

Right Side

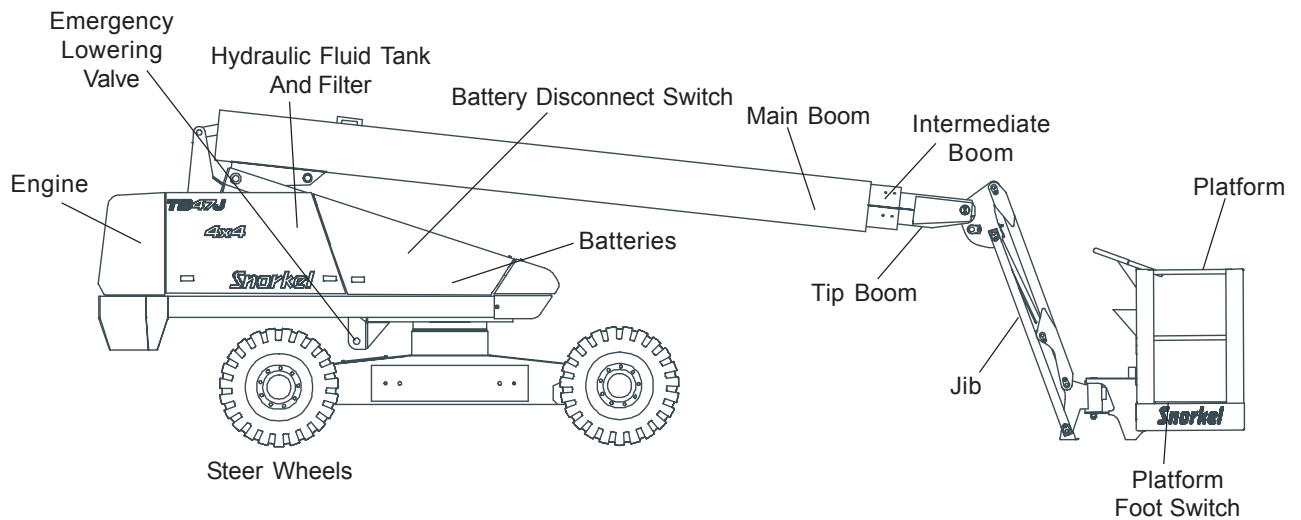

Left Side

Working Envelope

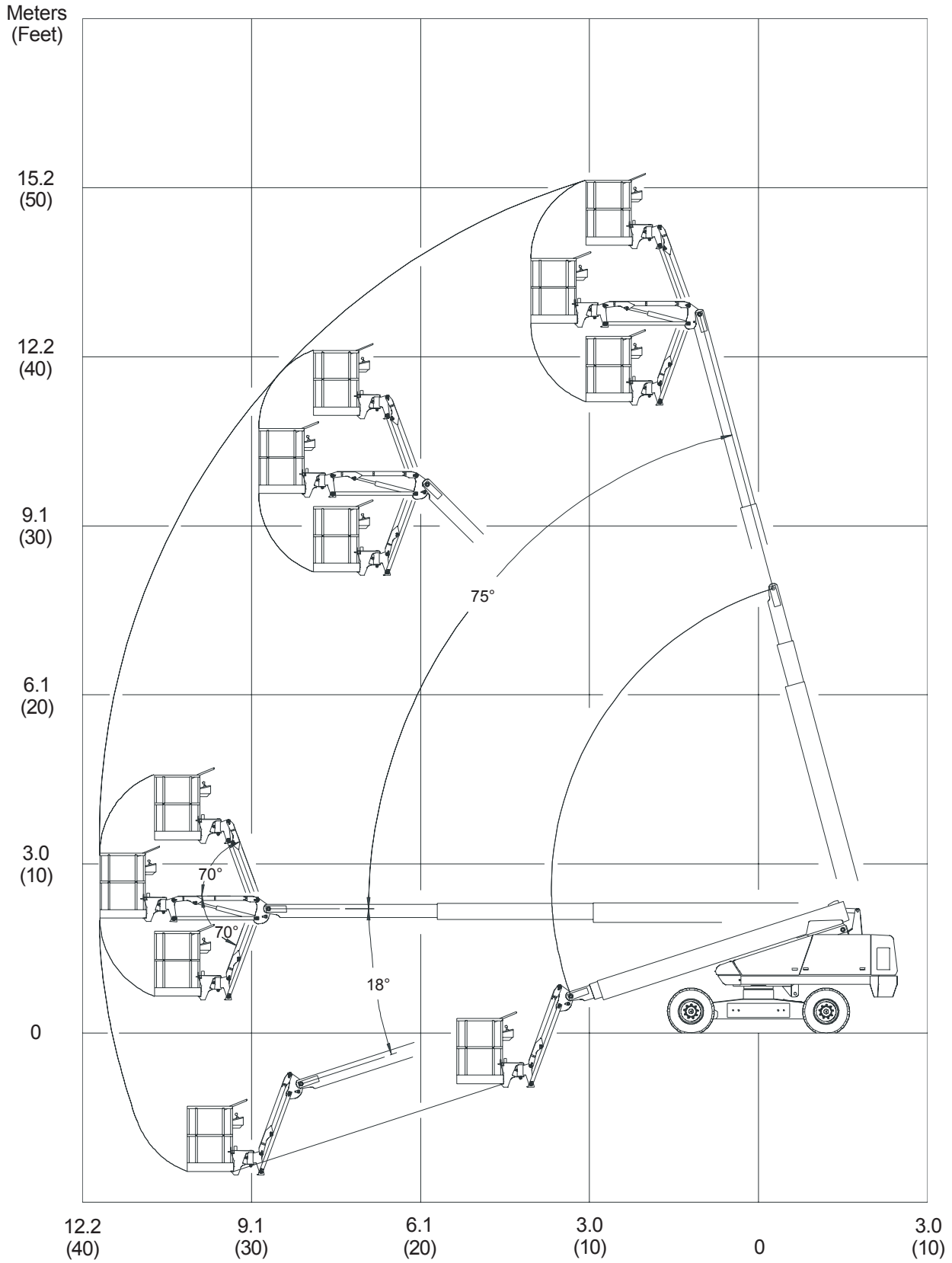

General Specifications

Aerial Platform

Working height	16 m (52' 6")
Maximum platform height	14.2 m (46' 6")
Horizontal reach	11.9 m (39')
Main boom	
Articulation	-18° to +75°
Extension	2.5 m (8' 4.75")
Turntable rotation	360° continuous
Turning radius, inside	
Two wheel drive	1.6 m (5' 2")
Four wheel drive	1.7 m (5' 6")
Wheelbase	2.4 m (8')
Ground clearance	25 cm (10")
Maximum wheel load	2,495 kg (5,500 lbs)
Maximum ground pressure	3.8 kg/cm ² (54 psi)
Weight, GVW	
Approximate	6,123 kg (13,500 lbs)
Stowed width	2.4 m (7' 11.5")
With flotation tires	2.6 m (8' 7.5")
Stowed length	8.1 m (26' 9")
Stowed length, tucked stow	6.5 m (21' 3.5")
Stowed height	2.3 m (7' 9")
Stowed height, tucked stow	2.4 m (7' 11.5")

Platform

Dimensions	
Standard steel	76 cm x 152 cm (30" x 60")
Rated work load	227 kg (500 lb)
Optional aluminum	76 cm x 234 cm (30" x 92")
Rated work load	227 kg (500 lb)
Optional aluminum	76 cm x 152 cm (30" x 60")
Rated work load	227 kg (600 lb)
Rotation	90° CW to 80° CCW
Maximum number of occupants	2 people
Optional AC generator	220 VAC

Function Speed

Turntable rotation, 360 degrees	108 to 113 seconds
Main boom	
Up	65 to 70 seconds
Down	65 to 70 seconds
Extend	40 to 45 seconds
Retract	25 to 30 seconds
Jib	
Up	25 to 35 seconds
Down	25 to 35 seconds
Platform rotation, 170 degrees	8 to 15 seconds
Drive	
High, booms stowed	4.8 km/h (3.0 mph)
Low, booms elevated	1.6 km/h (1.0 mph)

Drive System

Standard	Four wheel drive
Optional	Two wheel drive
Gradeability	25%

Tires

Street tread, 10 ply	30 cm x 42 cm (12" x 16.5")
Bar lug, 10 ply	30 cm x 42 cm (12" x 16.5")
Flotation, 10 ply	33/16LL-16.1
Foam filled, 10 ply	Street tread or bar lug

Electrical System

Voltage	12 V DC negative chassis ground
Source	Two - 12 V 600 CCA batteries
Fluid recommended	distilled water

Hydraulic System

Maximum pressure	20,684 kPa (3,000 psi)
Reservoir capacity	62.4 l (16.5 US gal)
System capacity	94.6 l (25 US gal)
Maximum operating temperature	93°C (200°F)
Hydraulic fluid recommended	
Above -13°C (10°F)	Mobil DTE-13M (ISO VG32)
Below -13°C (10°F)	Mobil DTE-11M (ISO VG15)

Engine

Diesel	Cummins B3.3
Diesel	Deutz F3L-2011F

Fuel Tank Capacity

Diesel	75.7 l (20 US gal)
--------	--------------------

Ambient Air Temperature Operating Range

Celsius	-18°C to 43°C
Fahrenheit	0°F to 110°F

Maximum Wind Speed

Gust or steady	45 km/h (28 mph)
----------------	------------------

Engine Specifications

Engine	CID	Fuel Grade	Coolant	Operating Temperature	Oil Capacity	Oil Grade
Cummins B3.3 Diesel	3.26 liter (199 cu. in.)	ASTM No. 2D fuel with a minimum Cetane number of 40. ¹ For operating temperatures below 0°C (32°F) use winterized No. 2D.	50% water 50% Antifreeze ²	60°C to 100°C 140°F to 212°F	7.5 liter (2 gal) total 1.5 liter (1.6 qt) Low to High	SAE 15W-40 ³ API: CH4/SG
Deutz F3L-2011F Diesel	2.0 liter (125 cu. in.)	<ul style="list-style-type: none"> • DIN 51 601 (February 1986).¹ • BS 2869: A1 and A2 (with A2 refer to Deutz manual about sulfur content)¹ • ASTM D 975-88: 1-D and 2-D • CEN EN 590 or DIN EN 590 • NATO Code F-54 and F-75 • For operating temperatures below 0°C (32°F) use winter grade diesel. 	Air	78°C to 95°C 172°F to 203°F	6.0 liter (1.59 US gal)	API: CD or higher ³

Note 1: Refer to the engine manufacturers manual for specific fuel recommendations and specifications.

Note 2: Ethylene glycol or Propylene glycol may be used. Refer to the Cummins® Operation and Maintenance Manual B3.3 Series Engines for specific coolant recommendations and specifications.

Note 3: Refer to the engine manufacturers manual for specific lubricating oil recommendations and specifications.

Engine Oil Viscosity

Cummins B3.3

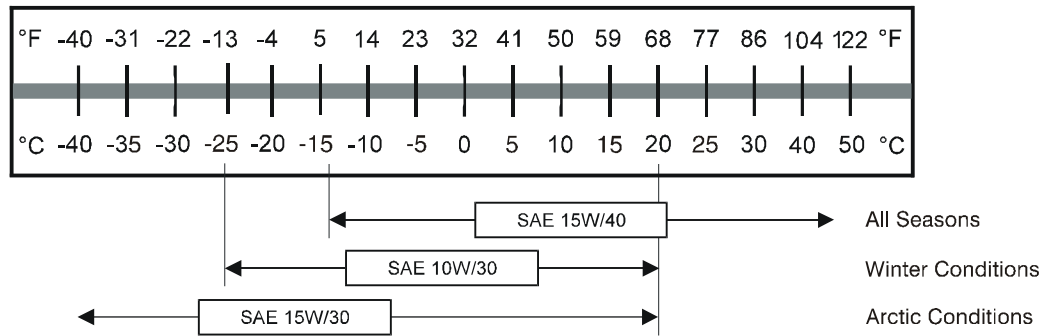

Deutz F3L-2011F

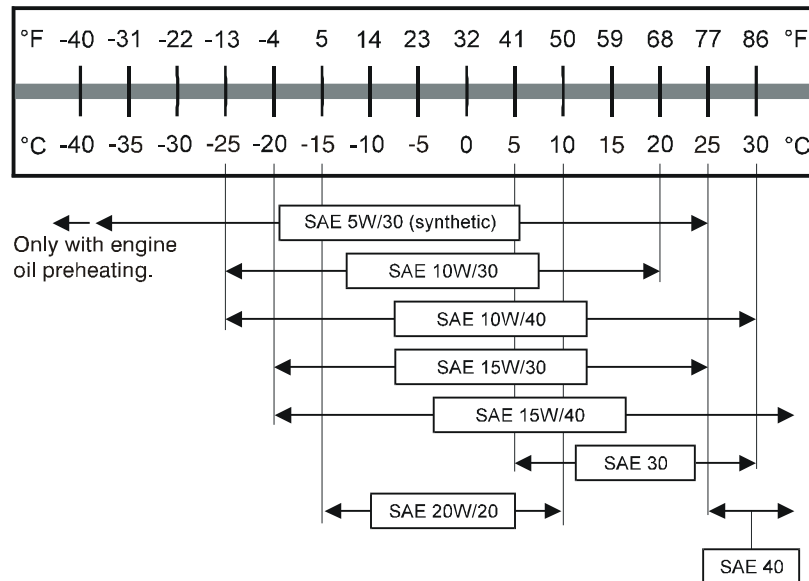

Chapter 3 – Safety

Knowledge of the information in this manual, and proper training, provide a basis for safely operating the aerial platform. Know the location of all controls and how they operate to act quickly and responsibly in an emergency.

Safety devices reduce the likelihood of an accident. Never disable, modify, or ignore any safety device. Safety alerts in this manual indicate situations where accidents may occur.

If any malfunction, hazard or potentially unsafe condition relating to capacity, intended use, or safe operation is suspected, stop aerial platform operation and seek assistance.

The operator bears ultimate responsibility for following all manufacturer's instructions and warnings, regulations and safety rules of their employer and/or any state or federal law.

Electrocution Hazards

The aerial platform is made of metal components and is not insulated. Regard all conductors as energized. Do not operate outside during a thunderstorm.

Minimum Safe Approach Distance

Minimum safe approach distances to energized power lines and their associated parts must be observed while operating the aerial platform.

⚠ Danger

The aerial platform is not electrically insulated. Death or serious injury will result from contact with, or inadequate clearance from, an energized conductor. Do not go closer than the minimum safe approach distance as defined by ANSI.

ANSI publications define minimum distances that must be observed when working near bus bars and energized power lines. Table 1 and Figure 3 are reprinted courtesy of Scaffold Industry Association, ANSI/SIAA92.5

Voltage Range (Phase to Phase)	Minimum Safe Approach Distance	
	Feet	Meters
0 to 300V	Avoid Contact	
Over 300V to 50kV	10	3.05
Over 50kV to 200kV	15	4.60
Over 200kV to 350kV	20	6.10
Over 350kV to 500kV	25	7.62
Over 500kV to 750kV	35	10.67
Over 750kV to 1000kV	45	13.72

Table 1 – Minimum Safe Approach Distance

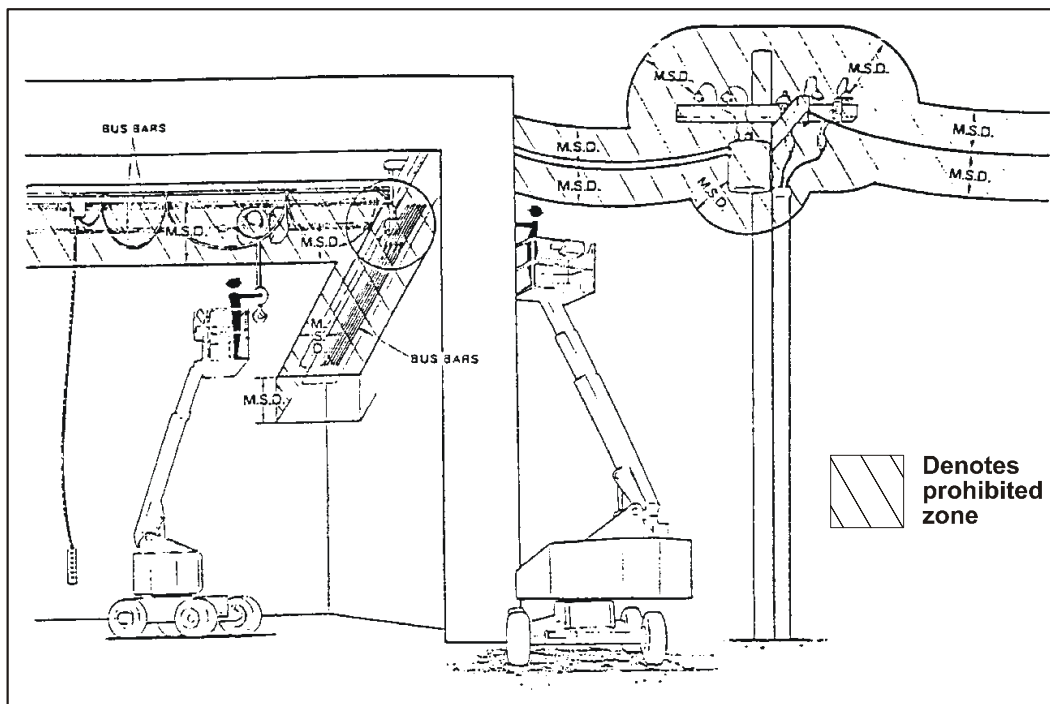

Figure 3 – Minimum Safe Approach Distance

Prestart Inspection

Perform a prestart inspection before each shift as described in Chapter 7. Do not use the aerial platform on the job unless you are trained and authorized to do so.

Work Place Inspection and Practices

Do not use the aerial platform as a ground connection when welding. The welding ground clamp must be attached to the same structure that is being welded. Electrical current flow can be very intense, causing serious internal damage to some components.

Inspect the area before and during aerial platform use. The following are some potential hazards that may be in the work place.

- Debris
- Slopes
- Drop-offs or holes
- Bumps and floor obstructions
- Overhead obstructions
- Unauthorized persons
- High voltage conductors
- Wind and weather conditions
- Inadequate surface and support to withstand load forces applied by the aerial platform in all operating configurations

Before using the aerial platform in any hazardous (classified) location, make certain it is approved and of the type required by ANSI/NFPA 505 for use in that particular location.

Know and understand the job site traffic-flow patterns and obey the flagmen, road signs, and signals.

While operating the aerial platform, a good safety practice is to have qualified personnel in the immediate work area to:

- Help in case of an emergency.
- Operate emergency controls as required.
- Watch for loss of control by platform operator.
- Warn the operator of any obstructions or hazards that may not be obvious to them.
- Watch for soft terrain, sloping surfaces, drop-offs, etc. where stability could be jeopardized.
- Watch for bystanders and never allow anyone to be under, or to reach through the booms while operating the aerial platform.

Danger

Pinch points may exist between moving components. Death or serious injury will result from becoming trapped between components, buildings, structures, or other obstacles. Make sure there is sufficient clearance around the machine before moving the chassis, booms, or platform. Allow sufficient room and time to stop movement to avoid contact with structures or other hazards.

Always look in the direction of movement. Drive with care and at speeds compatible with the work place conditions. Use caution when driving over rough ground, on slopes, and when turning. Do not engage in any form of horse-play or permit riders any place other than in the platform.

Secure all accessories, containers, tools, and other materials in the platform to prevent them from accidentally falling or being kicked off the platform. Remove all objects that do not belong in or on the aerial platform.

Never steady the platform by positioning it against another platform.

Do not operate the aerial platform if it is damaged or not functioning properly. Qualified maintenance personnel must correct the problem before putting the aerial platform back into service.

Operation

Use three points of support when entering or exiting the platform. For example, use two hands and one foot when climbing into the platform.

Never cover the platform floor grating or otherwise obstruct your view below. Make sure the area below the platform is free of personnel before lowering.

Keep both feet positioned firmly on the platform floor. Operate the controls slowly and deliberately to avoid jerky and erratic operation. Always stop the controls in neutral before going in the opposite direction.

Do not dismount while the aerial platform is in motion or jump off the platform.

Properly stow the aerial platform and secure it against unauthorized operation at the end of each work day, before transporting, or if it is left unattended.

Tip-Over and Falling Hazards

Operate the aerial platform only on a firm, flat, level surface capable of withstanding all load forces imposed by the aerial platform in all operating conditions. Refer to the General Specifications chart for the maximum wheel load and ground pressure. Raise the booms only when the aerial platform is on level ground.

Danger

The aerial platform can tip over if it becomes unstable. Death or serious injury will result from a tip-over accident. Do not drive or position the aerial platform for elevated use near any drop-off, hole, slope, soft or uneven ground, or other tip-over hazard. Do not raise the boom in winds above 45 km/h (28 mph).

All platform occupants must wear a fall restraint device connected to a lanyard anchor point.

It is best not to transfer from the platform to another structure or from the structure to the platform, unless that is the safest way to do the job. Judge each situation separately taking the work environment into account. If it is necessary to transfer from the platform to another structure the following guidelines apply:

1. Where possible, place the platform over a roof or walking structure to do the transfer.
2. Transfer your anchorage from one structure to the other before stepping across.
3. Remember that you might be transferring to a structure where *personal fall arrest* is required.
4. Use the platform entrance, do not climb over or through the guardrails.

Do not operate the aerial platform in windy or gusty conditions. Do not add anything to the aerial platform that will increase the wind loading such as billboards, banners, flags, etc.

Never operate the aerial platform without all parts of the guardrail system in place and the gate closed. Make sure that all protective guards, cowlings, and doors are securely fastened.

Do not exceed the platform capacity as indicated on the platform rating placard on the platform. Do not carry loads that extend beyond the platform guardrails without prior written consent from Snorkel.

Do not operate the aerial platform from trucks, trailers, railway cars, floating vessels, scaffolds, or similar equipment unless the application is approved in writing by Snorkel.

Do not use the aerial platform as a crane, hoist, jack, or for any purpose other than to position personnel, tools, and materials.

Do not climb on the guardrails or use ladders, planks, or other devices to extend or increase the work position from the platform.

Take care to prevent rope, electrical cords, and hoses, etc., from becoming caught in or on the aerial platform. If the platform or booms becomes caught on an adjacent structure or other obstacle and is prevented from normal motion, reverse the control to free the platform. If control reversal does not free the platform, evacuate the platform before attempting to free it.

Electrical System

Charge the batteries in a well-ventilated area free of flame, sparks, or other hazards that might cause fire or explosion.

Do not operate any of the aerial platform functions while the battery charger is plugged in.

Warning

Batteries give off hydrogen and oxygen that can combine explosively. Death or serious injury could result from a chemical explosion. Do not smoke or permit open flames or sparks when checking the batteries.

Battery acid can damage the skin and eyes. Serious infection or reaction can result if medical treatment is not given immediately. Wear face and eye protection when working near the batteries.

Batteries contain sulfuric acid that can damage your eyes or skin on contact. Wear a face shield, rubber gloves, and protective clothing when working around batteries. If acid contacts your eyes, flush immediately with clear water and get medical attention. If acid contacts your skin, wash off immediately with clear water.

Hydraulic System

The hydraulic system contains hoses with hydraulic fluid under pressure.

Danger

Hydraulic fluid escaping under pressure can have enough force to inject fluid into the flesh. Serious infection or reaction will result if medical treatment is not given immediately. In case of injury by escaping hydraulic fluid, seek medical attention at once.

Do not place your hand or any part of your body in front of escaping hydraulic fluid. Use a piece of cardboard or wood to search for hydraulic leaks.

Engine and Fuel Handling Precautions

Refer to the engine manufacturer's Operator's Manual for complete information on safe engine operation, maintenance, and specifications.

Danger

Engine exhaust contains carbon monoxide, a poisonous gas that is invisible and odorless. Breathing engine exhaust fumes will cause death or serious illness. Do not run the engine in an enclosed area or indoors without adequate ventilation.

Be careful not to run the diesel fuel tank empty. Bleed the fuel system if air enters the lines between the tank and the injection pump.

Allow the engine to return to idle before shutting the engine off.

Do not smoke or permit open flames while fueling or near fueling operations.

Never remove the fuel cap or fill the fuel tank while the engine is running or hot. Never allow fuel to spill on hot machine components.

Maintain control of the fuel filler nozzle when filling the tank. Spilled fuel is a potential fire hazard.

Do not overfill the fuel tank. Allow room for expansion.

Clean up spilled fuel immediately.

Tighten the fuel tank cap securely. If the fuel cap is lost, replace it with an approved cap from Snorkel. Use of a non-approved cap without proper venting may result in pressurization of the tank.

Never use fuel for cleaning purposes.

For diesel engines, use the correct fuel grade for the operating season.

Caution

Engine coolant escaping under pressure can cause serious burns. Shut the engine off and let it cool before removing the radiator cap.

Let the engine and radiator cool before adding coolant.

Placards and Decals

The aerial platform is equipped with placards and decals that provide instruction for operation and accident prevention. Do not operate the aerial platform if any placards or decals are missing or not legible.

Chapter 4 – Safety Devices

This aerial work platform is manufactured with safety devices, placards, and decals to reduce the likelihood of an accident. For the safety of all personnel, do not disable, modify, or ignore any safety device. Safety devices are included in the daily prestart inspection.

Warning

The potential for an accident increases when safety devices do not function properly. Death or serious injury can result from such accidents. Do not alter, disable, or override any safety device.

If any safety devices are defective, remove the aerial platform from service until qualified maintenance personnel can make repairs.

Emergency Stop Controls

There is an emergency stop control at the lower and upper controls.

At the lower controls, the emergency stop is a two-position push button (refer to Figure 4.1). Push the emergency stop button in to disconnect power to all control circuits. Pull the button out to restore power.

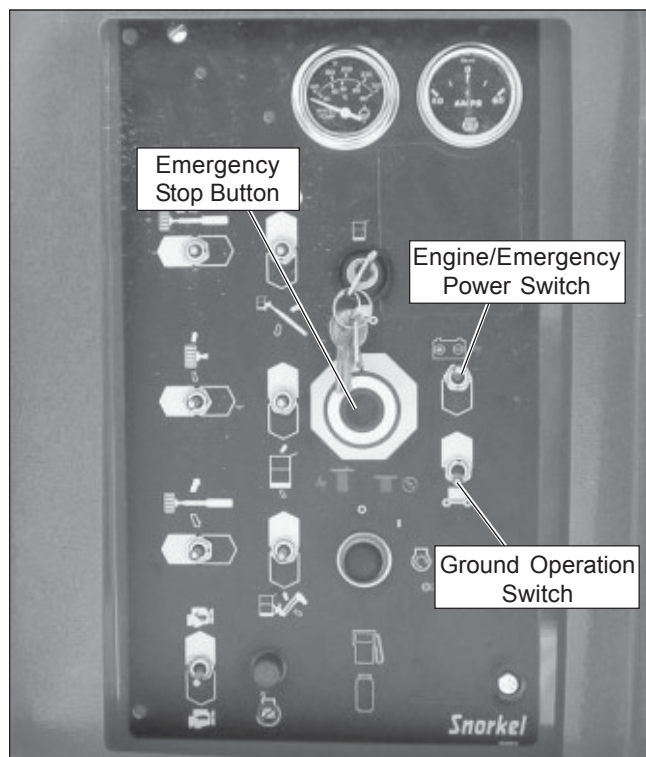

Figure 4.1 – Lower Controls

Note

The lower controls override the upper controls. If the upper control emergency stop button is engaged, the lower controls can still be used to operate the aerial platform.

At the upper controls, the emergency stop is a two-position push button (refer to Figure 4.2).

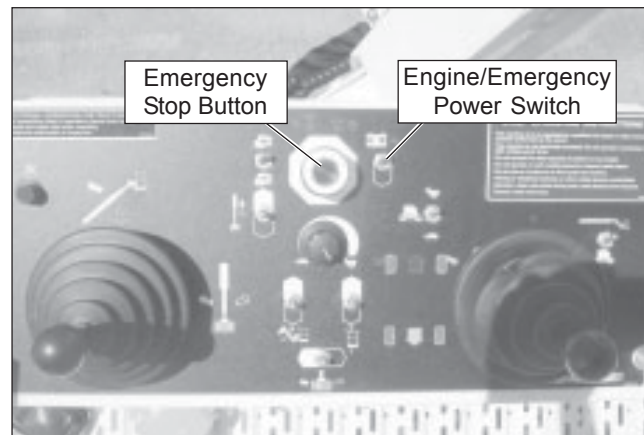

Figure 4.2 – Upper Controls

Push the emergency stop button in to disconnect power to the upper control circuits. Pull the button out to restore power.

Emergency Power System

The emergency power system includes a back-up pump, motor, and battery. Use this system to operate the boom and turntable functions to lower the platform if the main power system fails due to engine or pump failure. Hold the engine/emergency power switch (refer to Figure 4.1 and 4.2) down to activate the emergency power system.

The length of time the pump can be operated depends on the capacity of the battery.

Emergency Lowering Knob

The emergency lowering knob may be used to lower the booms if the engine will not start and the emergency power system will not work. The knob is on the base end of the main boom lift cylinder (refer to Figure 4.3) under the left side of the turntable.

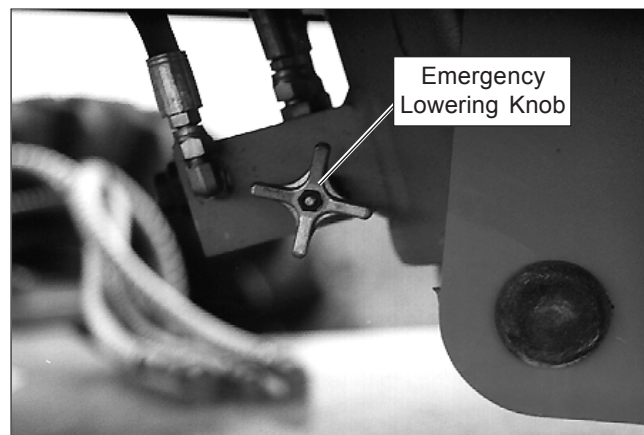

Figure 4.3 – Emergency Lowering Knob

Ground Operation Switch

The ground operation switch (refer to Figure 4.1) prevents boom and platform movement if a control switch on the lower control panel is accidentally moved.

Hold the switch up to operate the machine from the lower controls.

Platform Foot Switch

Stepping down on the platform foot switch (refer to Figure 4.4) activates the upper controls.

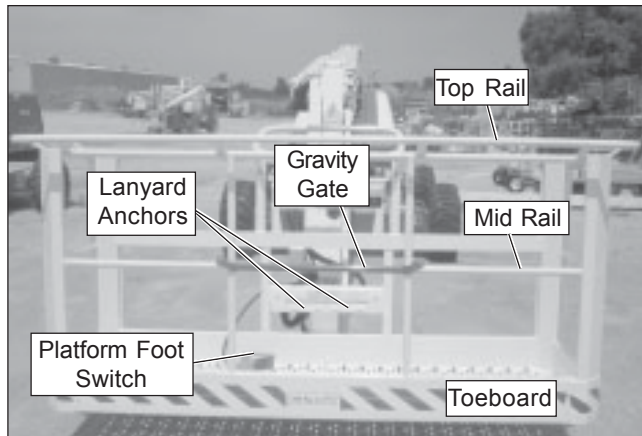

Figure 4.4 – Platform

The foot switch must be engaged and a control must be moved to operate the boom, drive, and/or platform from the upper controls.

Guardrails

The guardrail system includes a top rail, mid rail, and toeboards around the sides of the platform (refer to Figure 4.4).

A gravity gate (refer to Figure 4.4) or an optional swinging gate (refer to Figure 4.5) allows for access to the platform.

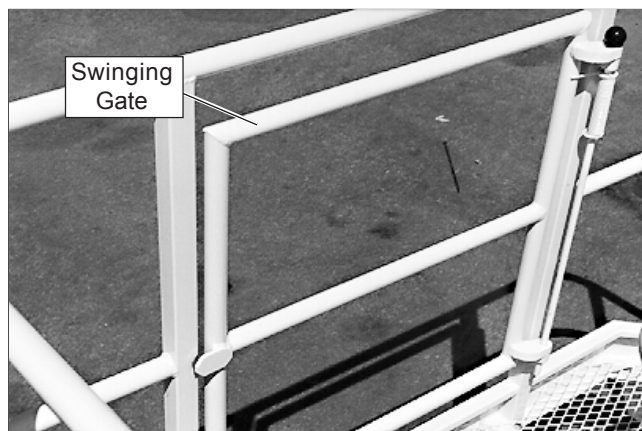

Figure 4.5 – Platform

The gates close automatically after entering or exiting the platform. The gate is part of the guardrail system and must be securely fastened after entering the platform.

Lanyard Anchors

Two lanyard anchors for fall restraint anchorage are provided below the upper controls at the front of the platform (refer to Figure 4.4).

Note

The lanyard anchors are not for lifting or tying the machine down.

All personnel in the platform must connect their fall restraint device to a lanyard anchor before raising the platform. Do not use the aerial platform for *personal fall arrest* anchorage.

Tilt Alarm

If the aerial platform chassis is out of level more than 3.5 degrees when the main boom is raised or extended, an alarm will sound. The tilt alarm is located under the upper control box (refer to Figure 4.6).

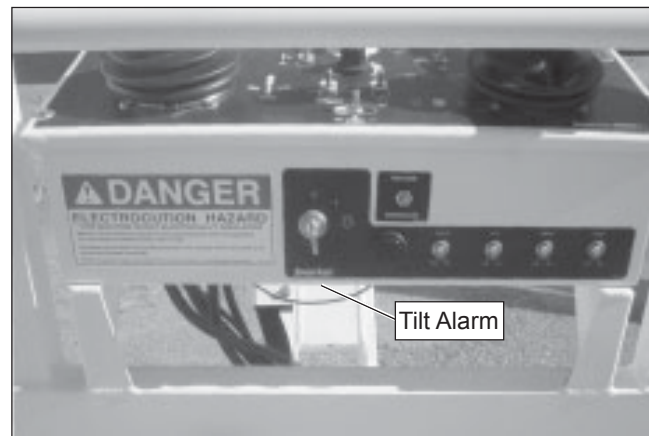

Figure 4.6 – Tilt Alarm

⚠ Danger

The aerial platform can tip over if it becomes unstable. Death or serious injury will result from a tip-over accident. Do not drive or position the aerial platform for elevated use near any drop-off, hole, slope, soft or uneven ground, or other tip-over hazard.

Retract and lower the main boom and then drive to a level surface when the tilt alarm sounds.

The tilt alarm is for added protection and does not justify operating on anything other than firm, flat, level surfaces.

Platform Overload Sensing System

Boom and drive functions are stopped when the platform load reaches or exceeds rated capacity. The horn will sound intermittently and the red light (refer to Figure 4.7) will illuminate when the platform rated work load is exceeded.

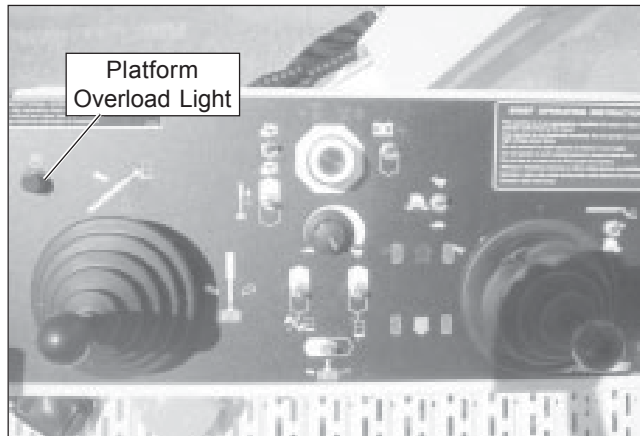

Figure 4.7 – Upper Controls

The horn will sound and the light will flash until the excess load is removed from the platform. At that time, the boom and drive functions are again operational.

If the overload exceeds rated platform capacity by more than 20 percent, the system will error out, stopping all boom and drive functions. The horn will then sound continuously and the red light will stay illuminated at the upper and lower controls (refer to Figure 4.8).

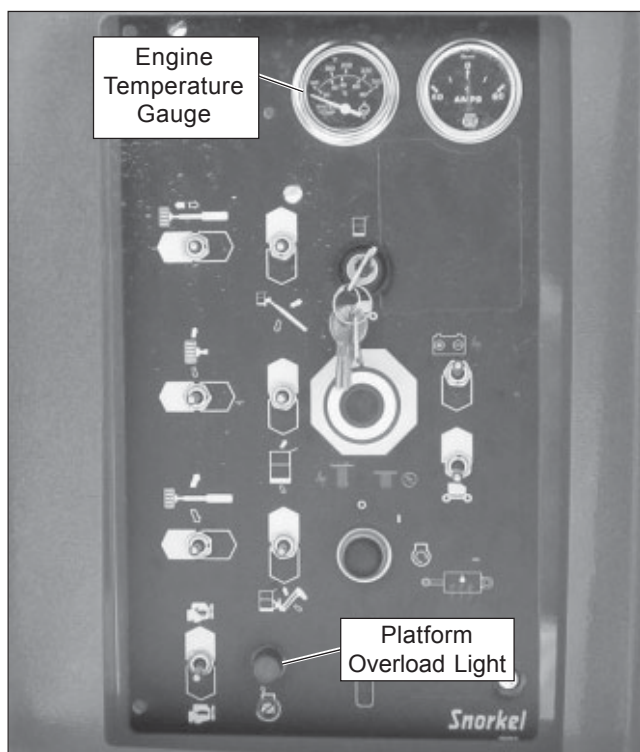

Figure 4.8 – Lower Control Panel

The horn will sound and the light will stay on until the excess load is removed from the platform and the start switch is turned off and back on, resetting the system. At that time, the boom and drive functions are operational.

⚠ Danger

The aerial platform can tip over if it becomes unstable. Death or serious injury will result from a tip-over accident. Do not exceed the capacity values indicated on the platform rating placard.

The overload sensing system is not active when the machine is being driven with the main boom below horizontal and fully retracted. This allows the machine to be driven without the system sensing an overload due to rough ground conditions.

To eliminate repeated tripping of the system during machine operation, there is a five second delay in machine functions following:

- starting the engine.
- placing the drive/boom selector switch in the boom position when the main boom is below horizontal and fully retracted.
- removing excess load from the platform.

Engine Protection Systems

A constant tone alarm will sound to warn against high engine temperature or low oil pressure.

The engine will shut-down if the operating temperature exceeds a preset level or if the oil pressure is too low for safe operation. An engine temperature gauge is on the lower control panel (refer to Figure 4.8).

High Engine Temperature Alarm

If the coolant in a Cummins engine exceeds the engine operating temperature an alarm will sound and the engine will shut off.

If the oil in a Deutz engine exceeds 110°C (230°F) an alarm will sound and the engine will shut off. Any time there is no alternator current being produced, an alarm will sound and the engine will shut off. This prevents high engine temperature if the fan belt breaks.

Do not restart the engine until the condition that caused the overheating has been corrected.

Low Oil Pressure Alarm

The low oil pressure alarm sounds when the engine oil pressure is near the lower limit for safe engine operation. If the alarm sounds, lower the platform to the ground and then turn the engine off. Do not restart the engine until the condition that caused the low oil pressure has been corrected.

If the engine oil pressure falls below a safe operating value the engine will shut off. The engine can be restarted with low oil pressure, but it will only run a few seconds before it shuts off again.

Horn

The horn may be used to warn personnel on the ground. The horn button is on the right side of the upper control box. The horn is operational when the machine is set up for operation from the upper controls.

Drive Motion Alarm

An optional drive motion alarm may be provided on the machine. When the drive/steer control is moved out of neutral the alarm sounds, in short beeps, to warn personnel in the work area to stand clear.

Flashing Light

An optional amber flashing light may be located on the top of the boom near the base end (refer to Figure 4.9). The flashing light warns personnel that the aerial platform is in the area.

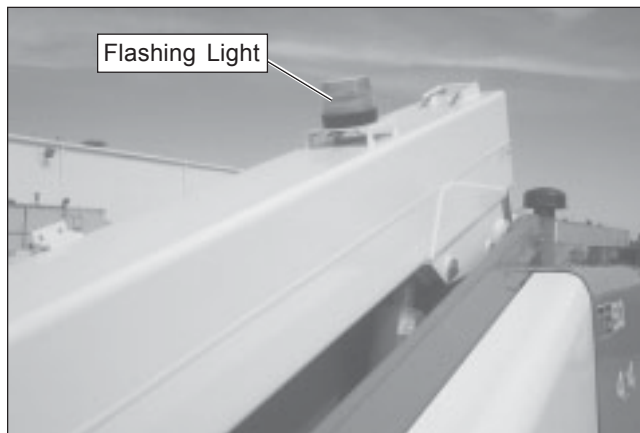

Figure 4.9 – Flashing Light

The light flashes at about one flash per second when the engine is running.

Driving Lights

Optional headlights and blinking tail lights may be installed on the machine. The headlights are located on the top of the front cowling. The tail lights are mounted on the sides of the rear cowling.

Driving lights help improve visibility while driving the aerial platform and help others see it too. Driving lights are not for driving on public roadways.

Platform Work Lights

Optional platform work lights may be located on the top rail of the platform, one on each side of the upper control panel.

Use the platform lights to improve visibility while working aloft in dimly lit areas. Do not use the platform work lights to drive on public roadways.

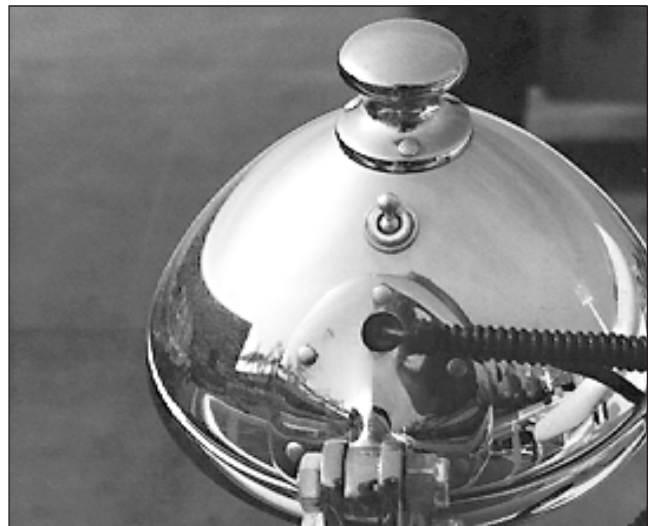

Figure 4.10 – Platform Work Lights

Chapter 5 – Gauges and Displays

The aerial platform is equipped with several gauges to monitor the condition of the machine before and during operation.

Hour Meter

The hour meter is located on the wiring box on the left side of the lower controls (refer to Figure 5.1). It measures the accumulated engine operating time.

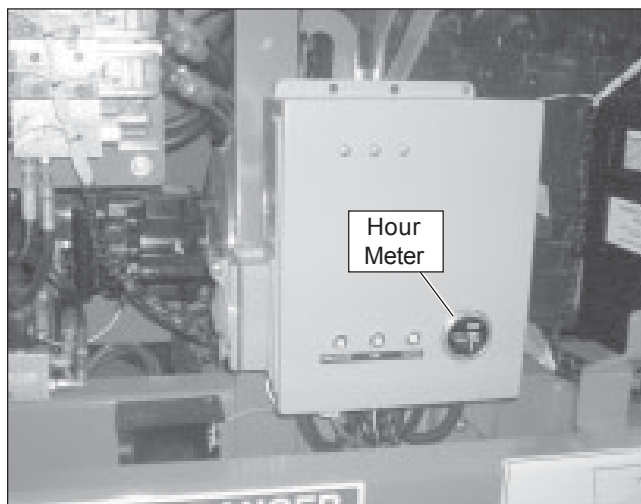

Figure 5.1 – Wiring Box

Engine Temperature Gauge

The temperature gauge is located on the lower control panel (refer to Figure 5.2).

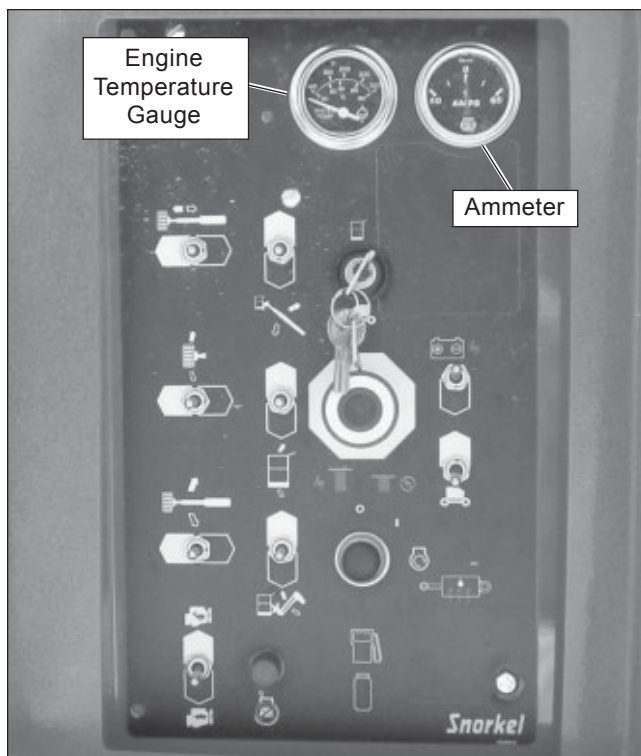

Figure 5.2 – Lower Controls

On liquid cooled engines it shows the temperature of the water and antifreeze mixture in the engine block. The gauge on air cooled engines shows the temperature of the engine oil as the oil leaves the filter.

Ammeter

The ammeter is located on the lower control panel (refer to Figure 5.2). The ammeter displays the level of current flow from the alternator to the batteries.

After the engine has been running for a few minutes under normal operating conditions, the ammeter gauge indicator should read “0.”

Engine Air Filter Gauge

The air filter gauge (refer to Figure 5.3) is located above the lower control panel. The gauge measures the air pressure between the intake manifold and the air filter.

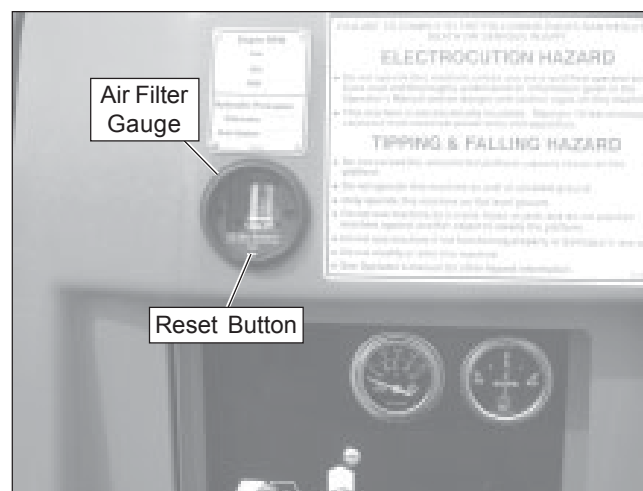

Figure 5.3 – Air Filter Gauge

The yellow indicator disk inside the sight glass stays at its highest level when the engine is turned off.

When the yellow indicator disk reaches the red area, it's time to change the filter element. After changing the filter, press the reset button to reset the indicator disk to the bottom of the sight glass.

Fuel

The fuel tank is translucent (refer to Figure 5.4). The amount of fuel in the tank can be gauged by raising the doors on the right side of the machine and looking at the tank.

Note

Do not run a diesel fuel tank empty. Air in the fuel line makes the engine hard to start.

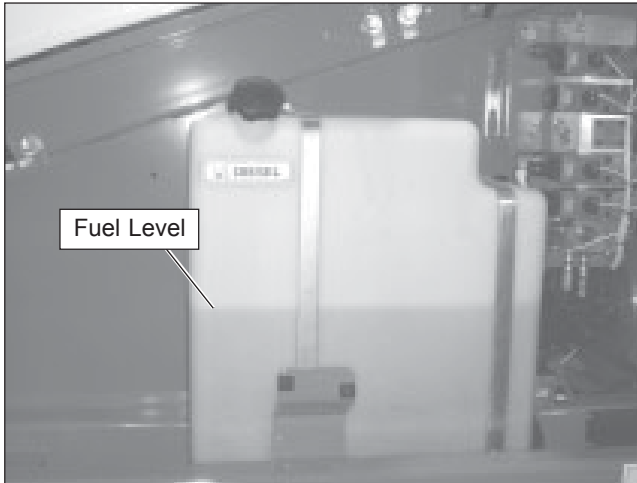

Figure 5.4 – Fuel Tank

Engine Oil

The engine oil level is measured with a dipstick. The dipstick is the only way to accurately determine the engine oil level. The engine oil level should always be between the add and full marks on the dipstick.

Hydraulic Fluid Filter Gauge

The fluid filter gauge (refer to Figure 5.5) is located on the return line filter on the left side of the reservoir. The reservoir is behind the door on the left side of the turntable. During high pump flow situations, the gauge indicates the condition of the filter. When the needle on the gauge is in the red zone, it is time to change the filter.

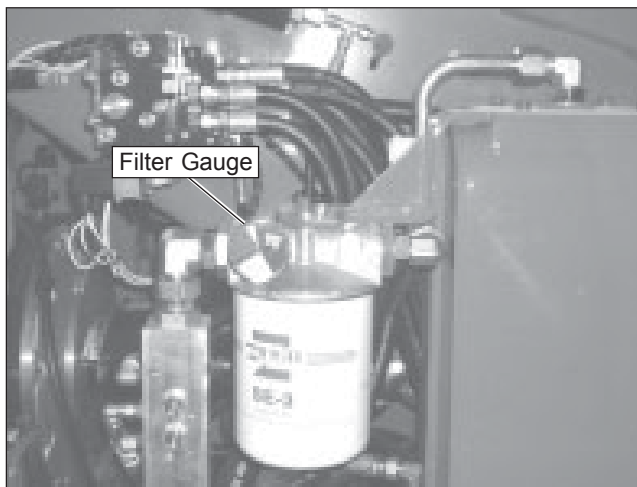

Figure 5.5 – Hydraulic Fluid Filter Gauge

Fluid Level and Temperature Gauge

A gauge on the right end of the reservoir displays the level and temperature of the hydraulic fluid (refer to Figure 5.6).

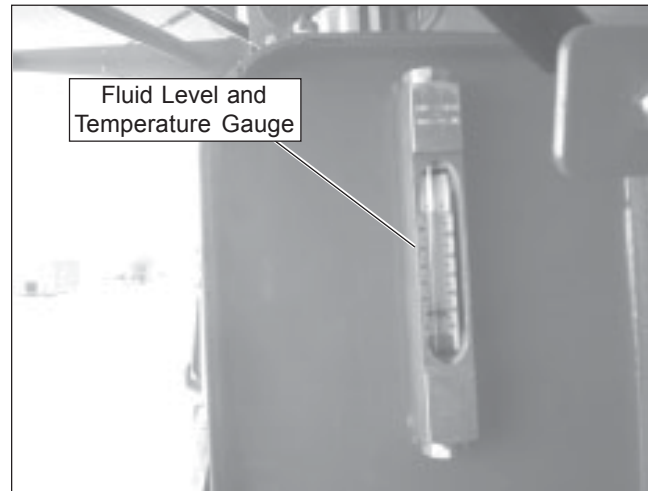

Figure 5.6 – Hydraulic Fluid Gauge

If the temperature rises above 93°C (200°F) stop machine operation and let the fluid cool before resuming operation.

Chapter 6 – Controls

⚠ Danger

Pinch points may exist between moving components. Death or serious injury can result from being trapped between components, buildings, structures, or other obstacles. Make sure all personnel stand clear while operating the aerial platform.

Controls to position the platform are located on the lower control panel on the turntable and on the upper control panel in the platform. Drive controls are located on the upper control panel only.

Battery Disconnect Switch

The battery disconnect is located behind the door on the left side of the turntable above the batteries (refer to Figure 6.1).

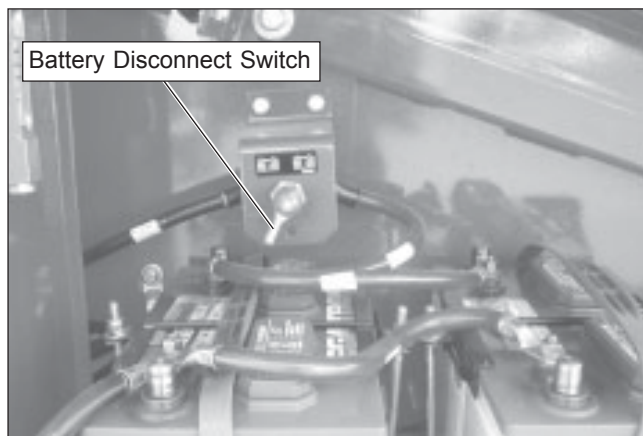

Figure 6.1 – Battery Disconnect Switch

The battery disconnect removes electrical power from all electrically controlled functions when in the off position. Place the switch in the on position to electrically connect the battery to the electrical system.

⚠ Caution

Only authorized personnel should operate the aerial platform. Unqualified personnel may cause injury to coworkers or property damage. Lock the battery disconnect switch in the off position before leaving the aerial platform unattended.

Turn the battery disconnect switch off to prevent unauthorized use of the aerial platform.

Lower Controls

The lower controls (refer to Figure 6.2) are located on the right side of the turntable. Boom and platform functions can be operated from the lower controls. The following are located on the lower control panel.

- Emergency stop button
- Control selector switch
- Start switch

- Ground operation switch
- Rotation switch
- Boom elevation switch
- Boom extend/retract switch
- Jib articulation switch
- Platform level switch
- Platform rotation switch
- Engine/emergency power switch
- Throttle switch

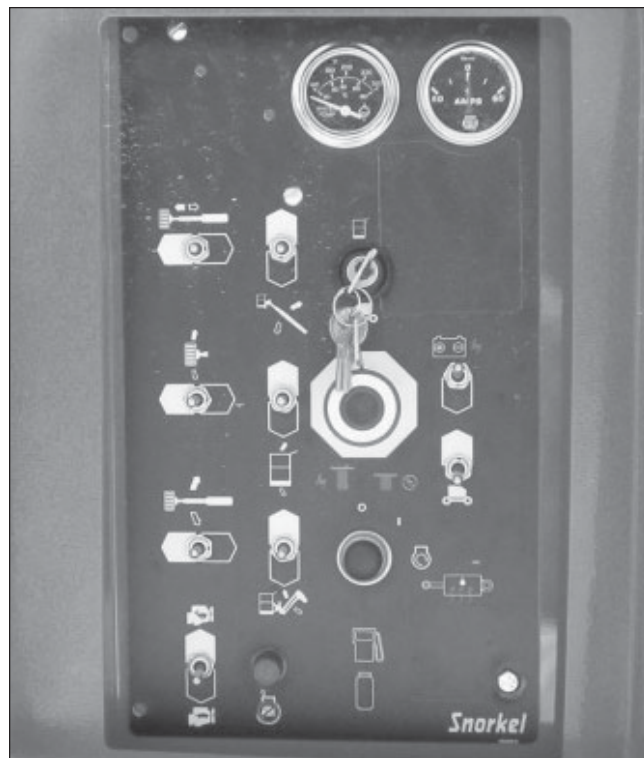

Figure 6.2 – Lower Controls

Emergency Stop Button

The emergency stop is a two-position, red push button. Push the button in to disconnect power to all control circuits. Pull the button out to restore power.

Control Selector Switch

Use the control switch to select between off, lower control, and upper control operation. Insert the key in the switch and turn the switch to the upper controls position to operate the aerial platform from the upper controls and in the lower controls position for lower controls operation.

Start Switch

The start switch works like an automobile ignition switch. Push the start button until the engine starts, then release it to on. If the engine dies, the control switch must be turned to off before the engine can be restarted.

An alarm sounds when the switch is turned on to warn others that the machine engine is being started.

Ground Operation Switch

Hold the switch upward continually to operate the machine from the lower controls. This switch is spring returned to the off position.

Rotation Switch

The rotation switch (refer to Figure 6.2) is used to rotate the turntable in a clockwise or counterclockwise direction. The switch is spring returned to the center off position.

Hold the switch to the right to rotate the turntable counterclockwise. Hold the switch to the left to rotate the turntable clockwise.

Boom Elevation Switch

The boom elevation switch (refer to Figure 6.2) is used to raise or lower the main boom. The switch is spring returned to the center off position.

Hold the switch up to raise the main boom. Hold the switch down to lower the main boom.

Boom Extend/Retract Switch

The boom extend/retract switch (refer to Figure 6.2) is used to extend or retract the booms. The switch is spring returned to the center off position.

Hold the switch to the left to extend the tip boom. Hold the switch to the right to retract the tip boom.

Jib Articulation Switch

The jib switch (refer to Figure 6.2) is used to raise or lower the jib. The switch is spring returned to the center off position.

Hold the switch up to raise the jib. Hold the switch down to lower the jib.

Note

The jib and platform rotate functions can not be operated at the same time. The platform rotate function will override the jib function.

Platform Level Switch

The platform level switch (refer to Figure 6.2) is used to level the platform floor with respect to the ground. The switch is spring returned to the center off position.

Hold the switch up to tilt the platform floor upward or away from the ground. Hold the switch down to tilt the platform floor downward or toward the ground.

Platform Rotation Switch

The platform rotation switch (refer to Figure 6.2) is used to rotate the platform relative to the end of the tip boom. The switch is spring returned to the center off position.

Hold the switch to the right to rotate the platform counterclockwise. Hold the switch to the left to rotate the platform clockwise.

Engine/Emergency Power Switch

Hold the engine/emergency power switch (refer to Figure 6.2) down to operate aerial platform functions using the emergency power system. Release the switch to disengage the emergency power system.

Note

The emergency power system is for lowering the platform during an emergency and is not intended for normal machine operation.

If the engine is running, it will stop when the switch is placed in the emergency power position.

Throttle Switch

The throttle switch (refer to Figure 6.2) is used to set the engine throttle speed to either low or high idle.

Place the switch in the low position before starting the engine and in the high position for machine operation and for engine and/or hydraulic system warm-up.

The engine has a two speed throttle operation from the lower controls. When the throttle switch is in the low position the engine is at idle. Placing the switch in the high position increases the engine speed to mid-range.

Placing the ground controls switch in the on position also increase the engine speed to mid-range.

Circuit Breaker Reset Buttons

The wiring box next to the lower control panel has a circuit breaker for the main, run, and throttle control circuits. There is a reset button for each circuit breaker on the front of the wiring box (refer to Figure 6.3).

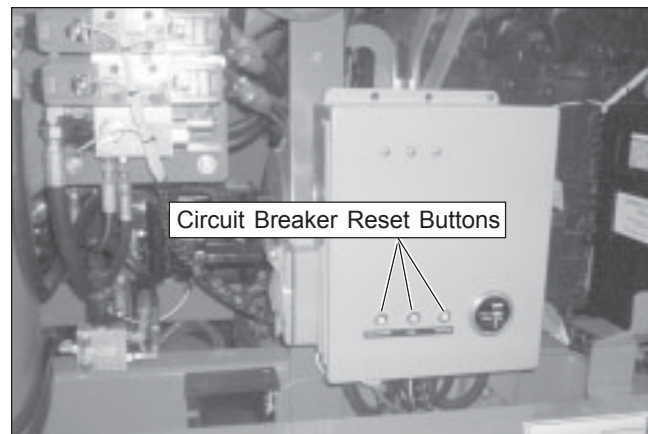

Figure 6.3 – Wiring Box

The upper control panel has a circuit breaker for the swing (turntable rotation), lift, drive and main control circuits. The circuit breakers are on the front of the upper control panel (refer to Figure 6.4).

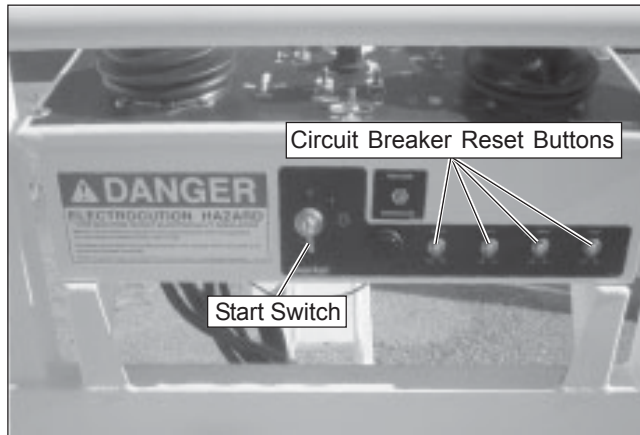

Figure 6.4 – Upper Control Panel Front

The circuit breakers protect the electrical wiring and components from electrical overload in case of a short circuit or other fault.

⚠ Caution

A tripped circuit breaker indicates a malfunction in the electrical system. Component damage can result if the cause of the malfunction is not corrected. Do not operate the aerial platform if the circuit breaker trips repeatedly.

Push the button to reset the circuit breaker.

Upper Controls

The upper controls (refer to Figure 6.5) are located on the control panel at the platform. Boom, platform, and drive functions can be operated from the upper controls. The following controls are located on the upper control panel.

- Start switch
- Emergency stop button
- Speed knob
- Drive/boom selector switch
- Boom joystick
- Drive joystick
- Drive range switch
- Jib articulation switch
- Platform level switch
- Boom extend/retract switch
- Engine/emergency power switch
- Throttle switch
- Platform rotate switch

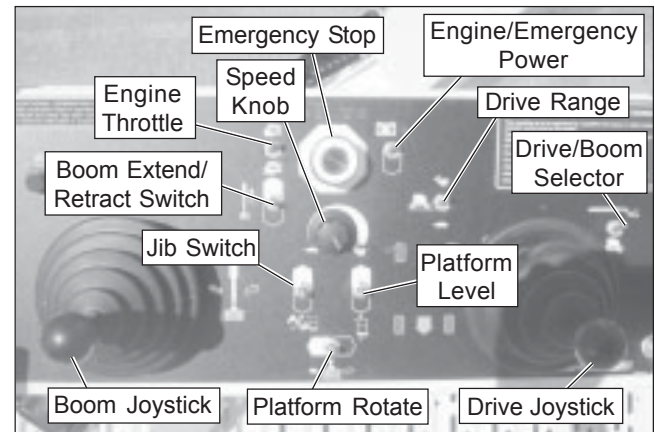

Figure 6.5 – Upper Control Panel Top

Start Switch

The engine can be started from the platform using the anti-restart master switch on the front of the upper control panel (refer to Figure 6.4).

This switch is similar to an automobile ignition switch. Turn the switch to start until the engine starts, then release it to on. If the engine dies, the switch must be turned to off before it can be turned back to start.

An alarm sounds when the switch is turned on to warn others that the machine engine is being started.

Note

On some machines it may be necessary to pause about three seconds in the on position before going to start so the starter can engage.

Turn the switch to off to turn the engine off and save fuel if the platform is to stay in a particular position for a long time.

Emergency Stop Button

The emergency stop is a two-position, red push button on the top of the upper control panel (refer to Figure 6.5). Push the button in to disconnect power to all control circuits at the upper controls. Pull the button out to restore power.

Note

The lower controls override the upper controls. If the upper control emergency stop button is engaged the lower controls can still be used to operate the aerial platform.

Push the emergency stop button in when the upper controls are not in use to protect against unintentional operation.

Speed Knob

Use the boom speed control knob (refer to Figure 6.5) to control the speed of the following boom functions.

- Boom extend/retract
- Jib up/down
- Platform rotate clockwise/counterclockwise

Set the knob to slow when beginning a boom movement. The speed may be increased by slowly rotating the knob toward fast. For smooth operation, rotate the knob to slow when ending boom movement.

Drive/Boom Selector Switch

Place the drive/boom selector switch (refer to Figure 6.5) in the drive position to drive the aerial platform.

Place the drive/boom selector switch in the boom position to operate the boom functions.

Note

Boom and drive functions can not be operated at the same time.

Boom Joystick

The boom joystick (refer to Figure 6.5) is used to raise and lower the main boom and to rotate the turntable. The boom and turntable functions may be operated simultaneously.

Note

The distance the joystick is moved is proportional to the speed of the function.

Hold the joystick forward to raise the main boom and backward to lower the boom.

Hold the joystick to the right to rotate the turntable counterclockwise and to the left to rotate the turntable clockwise.

Drive Joystick

The drive joystick (refer to Figure 6.5) is used to control forward and reverse motion of the aerial platform. It is also used to steer the machine. The steering and drive functions may be operated simultaneously.

Note

The distance the joystick is moved is proportional to the speed of the function.

Hold the joystick forward to move the aerial platform forward and backward to move in reverse as indicated by the directional arrows on the chassis.

Hold the joystick to the right to steer the aerial platform to the right and to the left to steer to the left as indicated by the directional arrows on the chassis.

Note

The steering wheels are not self-centering. Set the steering wheels straight ahead after completing a turn.

Drive Range Switch

The drive range switch (refer to Figure 6.5) has two positions to select drive wheel operation:

- HI – high speed and low torque operation.
- LO – low speed and high torque operation.

Jib Articulation Switch

The jib switch (refer to Figure 6.5) is used to raise or lower the jib. The switch is spring returned to the center off position.

Hold the switch up to raise the jib. Hold the switch down to lower the jib.

Note

The jib and platform rotate functions can not be operated at the same time. The platform rotate function will override the jib function.

Boom Extend/Retract Switch

The boom extend/retract switch (refer to Figure 6.5) is used to extend or retract the tip and intermediate booms. The switch is spring returned to the center off position.

Hold the switch down to extend the booms. Hold the switch up to retract the booms.

Platform Rotate Switch

The platform rotate switch (refer to Figure 6.5) is used to rotate the platform relative to the end of the tip boom. The switch is spring returned to the center off position.

Hold the switch to the left to rotate the platform clockwise. Hold the switch to the right to rotate the platform counterclockwise.

Platform Level Switch

The platform level switch (refer to Figure 6.5) is used to level the platform floor with respect to the ground. The switch is spring returned to the center off position.

Hold the switch up to tilt the platform floor upward or away from the ground. Hold the switch down to tilt the platform floor downward or toward the ground.

Engine/Emergency Power Switch

The engine/emergency power switch (refer to Figure 6.5) is spring returned to the engine position for aerial platform engine operation.

Place the switch in the emergency power position and hold to operate aerial platform functions using the emergency power system. Release the switch to disengage the emergency power system.

Note

The emergency power system is for lowering the platform during an emergency and is not intended for normal machine operation.

If the engine is running, it will stop when the switch is placed in the emergency power position.

Throttle Switch

The throttle switch (refer to Figure 6.5) is used to set the engine throttle speed to either low or high idle.

Place the switch in the low position for normal machine operation and in high to drive at maximum speed.

The engine has a three speed throttle operation from the upper controls. Independent of the throttle switch, the platform foot switch, when depressed, increases the engine speed from low to mid-range.

High engine speed is obtained when the main boom is horizontal, the foot switch is depressed, the throttle switch is in the high position, and the drive joystick is moved out of neutral into the forward or reverse position.

The machine can be driven in mid-range engine speed with the throttle switch place in the low position.

Horn Button

The horn button is on the right side of the upper control panel. Press the button to sound the horn.

Platform Foot Switch

The upper controls are interlocked through the platform foot switch (refer to Figure 6.6). Step down on and hold the platform foot switch to activate the drive and boom functions from the upper controls.

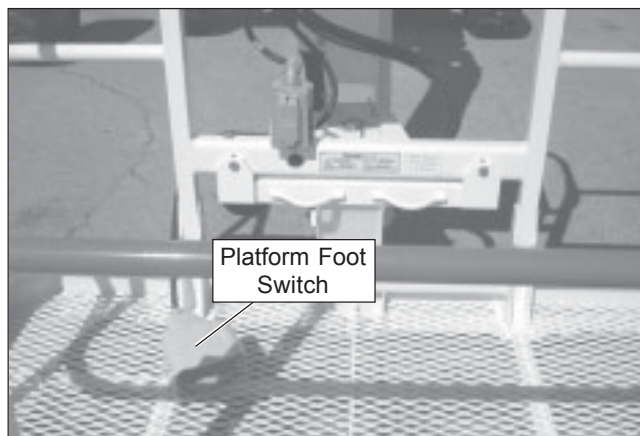

Figure 6.6 – Platform

Machine/Generator Switch

The switch for the optional AC generator is located on the front of the upper control panel.

With the engine running, place the switch in the generator position to provide electrical power to the electrical outlet at the platform. Place the switch in the machine position to turn off the generator and resume machine operation.

Machine functions will not operate while the switch is in the generator position.

Driving and Platform Work Lights

The control for the optional driving lights is on the back of each light. Place the switch in the on position to operate the driving lights.

The control for the optional platform work lights is on the back of each light (refer to Figure 6.7).

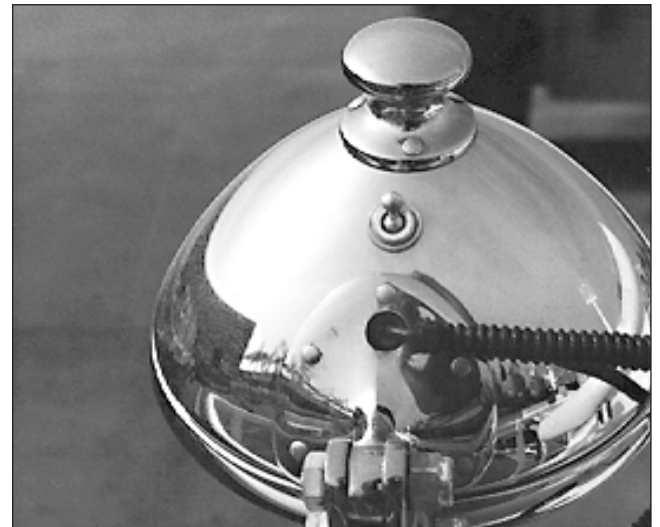

Figure 6.7 – Platform Work Lights

Chapter 7 – Prestart Inspection

Potential service and safety problems may be detected by inspecting the aerial platform. This chapter includes information on properly inspecting the aerial platform and includes a prestart inspection check list at the end of the chapter to ensure that no areas are overlooked.

Warning

The potential for an accident increases when operating an aerial platform that is damaged or malfunctioning. Death or serious injury can result from such accidents. Do not operate the aerial platform if it is damaged or malfunctioning.

Perform a prestart inspection at the beginning of each shift, before using the aerial platform on the job. The inspection site must have a smooth and level surface.

Operator's Manual

The manual holder is located behind the front cowling door (refer to Figure 7.1) on the right side of the machine.



Figure 7.1 – Operator's Manual Holder

Check to see that the proper Operator's Manual is in the holder. The manual should be complete with all pages intact and in readable condition.

Engine

Open the engine compartment doors on both sides of the machine and visually inspect the engine and its components with the engine off.

Oil Level

Check the engine oil level before starting the engine so the oil has drained to the pan. The proper oil level is between the add and full marks on the dipstick.

The distance between the top and bottom dipstick marks corresponds to about 1 l (1 quart US). Add oil, if necessary, before starting the engine.

Coolant

Cummins engines are liquid cooled. The coolant reservoir is behind the front cowling door on the left side of the machine (refer to Figure 7.2). When the engine is cold, there should be about 2.5 cm (1") of coolant in the bottom of the reservoir.

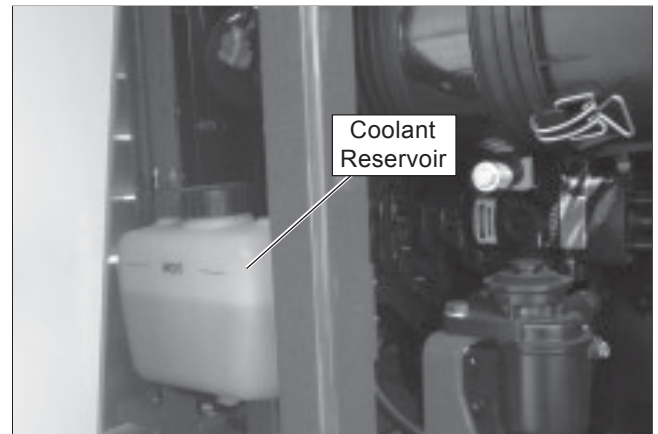

Figure 7.2 – Coolant Reservoir

Caution

Engine coolant escaping under pressure can cause serious burns. Shut the engine off and let it cool before removing the radiator cap.

Add coolant, if necessary, when the engine is cold and not running. When running at operating temperature the coolant should be at the hot level.

Deutz engines are air cooled. Visually inspect the air intake and fan (refer to Figure 7.3) to be sure they are free of obstructions that could stop or slow the flow of air. Inspect the fan belt to see that it is in place and not cracked.

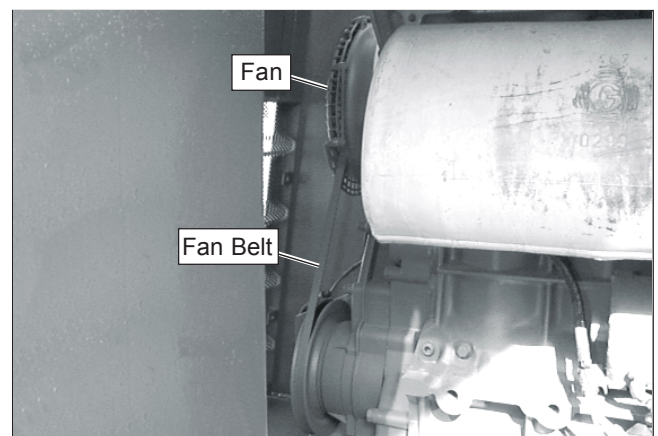

Figure 7.3 – Deutz Air Intake

Radiator

Inspect the radiator hoses and clamps for wear, leakage, or damage. Make sure the hoses are not hardened, cracked, or feel spongy. Make sure the cap is in place and tight.

Coolant leaks are easily visible on the ground. Check under the chassis for coolant that has leaked.

Make sure the radiator core and ventilation openings on the cover are free of bugs, dirt, or foreign material that might restrict airflow.

Fuel Tank

Check the fuel level (refer to Figure 7.4) and add fuel if necessary. Make sure the cap is securely fastened on gasoline or diesel tanks.

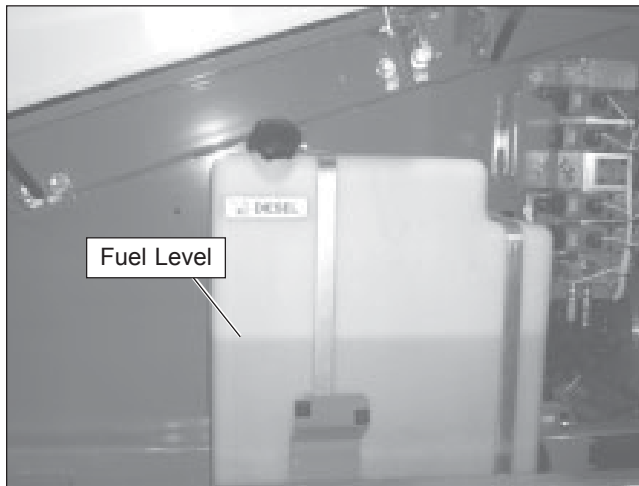

Figure 7.4 – Fuel Tank

Fuel Line

Visually inspect the entire length of the fuel line for leaks and damage. Start at the fuel tank and trace the line to the engine inspecting.

Air Filter

The air filter gauge (refer to Figure 7.5) has an indicator to show when the filter needs replaced.

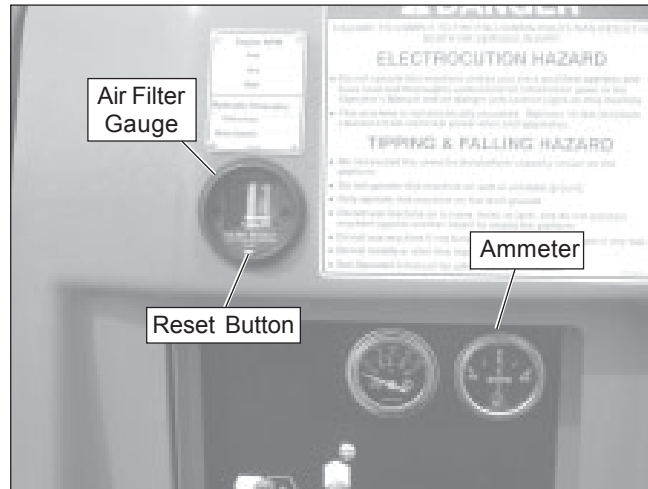

Figure 7.5 – Gauges at Lower Controls

To inspect the air filter:

1. Turn the battery disconnect switch on and close the cowling door.
2. At the lower controls, pull the emergency stop button outward.
3. Insert the key into the control switch and press the start button to turn the engine on.
4. Check the clear zone after running the engine for 30 seconds.
 - If the indicator is in the red area, replace the filter.
 - If the indicator is in the clear area, the filter is OK.
5. Shut off the engine.

Charging System

When the engine is running, the ammeter needle (refer to Figure 7.6) should be to the right of "0." Left of the "0" is discharging.

Cold Weather Start Kit—Block Heater

If the machine engine is a Cummins that is equipped with an optional engine block heater, visually inspect the heater and power cord. Inspect for leaks around the heater and for damage to the power cord.

Electrical System

Electrical power is supplied from either one or two, 600 CCA, 12 volt batteries. These batteries supply 12 volt DC electrical power to operate the aerial platform electrical and electrohydraulic components.

Machines with gasoline engines have one battery and machines with diesel engines have two batteries.

⚠ Warning

Batteries give off hydrogen and oxygen that can combine explosively. Death or serious injury can result from a chemical explosion. Do not smoke or permit open flames or sparks when checking the batteries.

⚠ Caution

Even with low voltage electrical systems, severe arcing can occur. Electrical shock or component damage can result from contact with energized conductors. Use caution when working with any electrical device.

The batteries are behind the door on the left side of the turntable.

Emergency Power Battery

The emergency power battery (refer to Figure 7.6) is behind the door on the right side of the chassis. The battery is automatically charged when the engine is running.

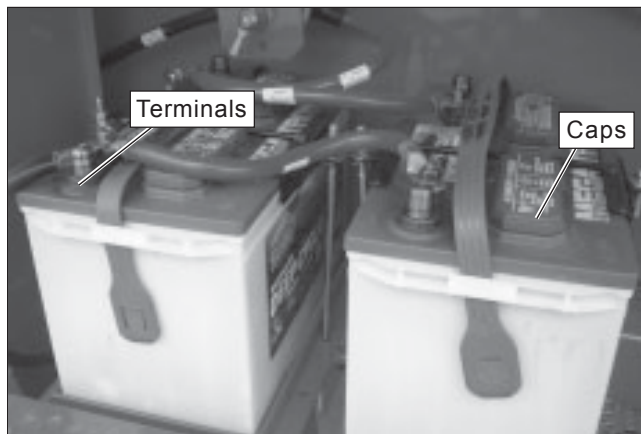

Figure 7.6 – Emergency Power Battery

Include the emergency power battery when inspecting and servicing the electrical system.

Battery Fluid Level

Remove the caps from each battery (refer to Figure 7.6). Visually check the battery fluid level. If the level is not within 6 mm ($\frac{1}{4}$ ") of the bottom of the filler neck inside each hole, add distilled water.

Replace the caps on the batteries. The caps must be in place and tight during machine operation.

Battery Terminals

Check the top of the batteries, the terminals, and cable ends (refer to Figure 7.6). They should be clean and free of corrosion. Clean the top of the batteries if necessary.

Clean the terminals and cable ends with a wire brush or terminal cleaning tool. All cable ends must be securely fastened to the terminals.

Cables and Wiring Harness

Inspect all cables and wiring for wear and/or physical damage such as loose connections, broken wires, and frayed insulation. Check the wiring in areas where a change in routing direction may cause them to become pinched. Make sure the cables and wires are properly routed to avoid sharp edges, pinching, and scuffing.

Hydraulic System

Hydraulic power is supplied from an engine driven variable displacement piston pump.

⚠ Danger

Hydraulic fluid escaping under pressure can have enough force to inject fluid into the flesh. Serious infection or reaction will result if medical treatment is not given immediately. In case of injury by escaping hydraulic fluid, seek medical attention at once.

The hydraulic reservoir is behind the door on the left side of the turntable. The pump is mounted on the engine.

Fluid Level

Check the hydraulic reservoir fluid level with the aerial platform stowed on a level surface. The fluid level must be between the full and add marks as viewed on the sight glass (refer to Figure 7.7).

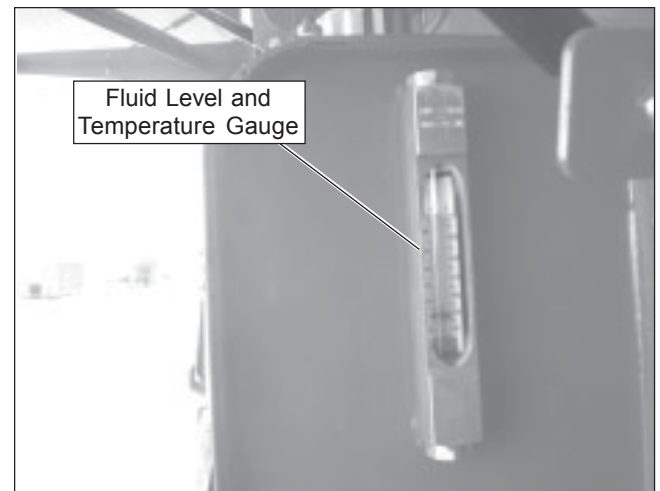

Figure 7.7 – Fluid Level Indicator

⚠ Caution

Not all hydraulic fluid is suitable to use in the hydraulic system. Some have poor lubricating characteristics and can increase component wear. Only use hydraulic fluid as recommended.

Chapter 7 – Prestart Inspection

If necessary, remove the filler cap and add fluid of the proper type. Refer to Chapter 2 for the proper type and grade of hydraulic fluid to use. The need to regularly add fluid indicates a leak that should be corrected.

The sight glass on the reservoir has an internal thermometer to measure the fluid temperature. The temperature should be less than 93°C (200°F).

Fluid Filter

Checking the condition of the hydraulic fluid filter is part of the machine maintenance schedule and should not be performed by the operator.

Hoses, Tubes, and Fittings

Inspect all hydraulic hoses, tubes, and fittings for wear, leakage, or damage (refer to Figure 7.8). Make sure the hoses are properly routed to avoid sharp edges, kinking, and scuffing. Inspect the tubes for dents or other damage that may restrict fluid flow. Make sure all hoses and tubes are held firmly in their support brackets.



Figure 7.8 – Hoses, Tubes, and Fittings

Hydraulic fluid leaks are easily visible on the ground. Check under the chassis for fluid that has leaked.

Tires and Wheels

Visually inspect the tires and wheels (refer to Figure 7.9) to make sure they are suitable for service. Check the wheel lug nuts to see that none are missing, damaged, or loose.



Figure 7.9 – Tires and Wheels

The aerial platform has foam filled tires. Foam filled tires do not have a pressure decal or a valve core.

Inspect for large holes or cuts where foam is coming out of the tire. Look for large imbedded objects, such as angle iron, that can rip a tire open.

Punctures caused by bolts, screws, or nails are not a problem for foam filled tires.

Lower Control Station

With no personnel in the platform, test the operation of each control from the lower controls (refer to Figure 7.10).

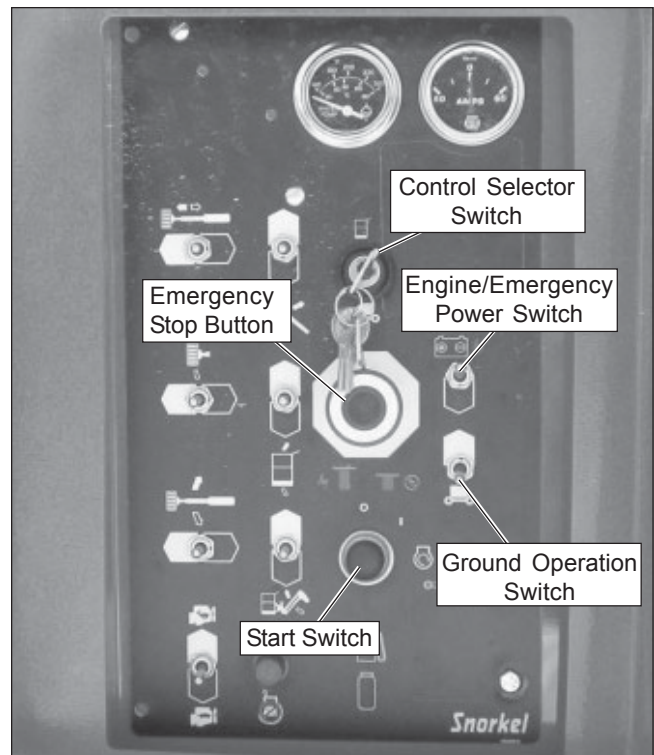

Figure 7.10 – Lower Controls

Operating Controls

Use the following procedure to operate the machine from the lower controls.

1. Turn the battery disconnect switch on.
2. At the lower controls, pull the emergency stop button outward. Insert the key in the control selector switch and turn the switch to the lower control position.
3. Press the start button until the engine starts, then release.
4. Let the engine warm to operating temperature.
5. Hold the ground operation switch upward.

⚠ Danger

Pinch points may exist between moving components. Death or serious injury will result from becoming trapped between components, buildings, structures, or other obstacles. Make sure all personnel stand clear of the aerial platform while performing the prestart inspection.

6. Test the operation of each function in both directions.

Note

When checking the turntable rotation function in the clockwise direction, the turntable will rotate toward you.

Emergency Stop

Push the emergency stop button in to turn off the engine. The lower control functions should not operate with the emergency stop in this position.

Emergency Power

Place the battery disconnect switch, the emergency stop button, and the master switch in the on position.

Hold the engine/emergency power switch in the emergency power position and the ground operation switch in the on position to operate the aerial platform from the lower controls using the emergency power system.

Emergency Lowering

The main boom can be lowered in an emergency using the emergency lowering knob. The emergency lowering knob is at the base of the main boom lift cylinder (refer to Figure 7.11).

Use the following procedure to test the emergency lowering system.

1. Use the lower controls to raise the main boom.

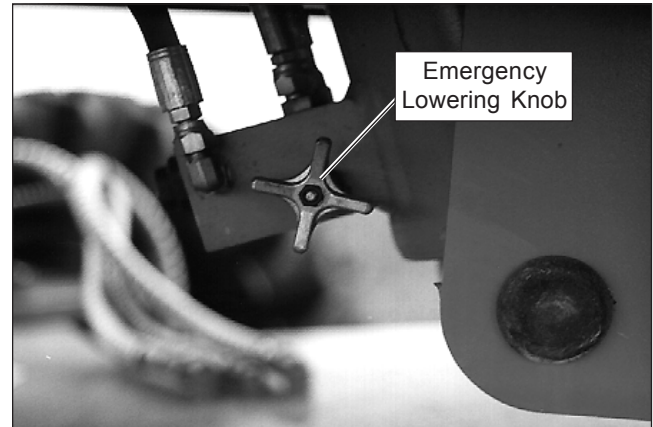

Figure 7.11 – Emergency Lowering Knob

2. Turn the engine off.

⚠ Danger

Pinch points may exist between moving components. Death or serious injury will result from becoming trapped between components. Stand clear of moving components while test operating the machine.

3. Slowly turn the knob to open the bleed down valve. The boom should slowly lower by gravity.

⚠ Warning

The potential for an accident increases when safety devices do not function properly. Death or serious injury can result from such accidents. Fully close the emergency lowering knob before operating the aerial platform.

4. Turn the knob to close the cylinder bleed down valve.

Level Sensor

Use the following procedure to test the level sensor.

1. Position the aerial platform on a smooth, flat, level surface.
2. Remove all persons and materials from the platform.
3. Start the engine and raise the main boom to just above horizontal.
4. Open the rear door on the left side of the machine to access the level sensor (refer to Figure 7.12).

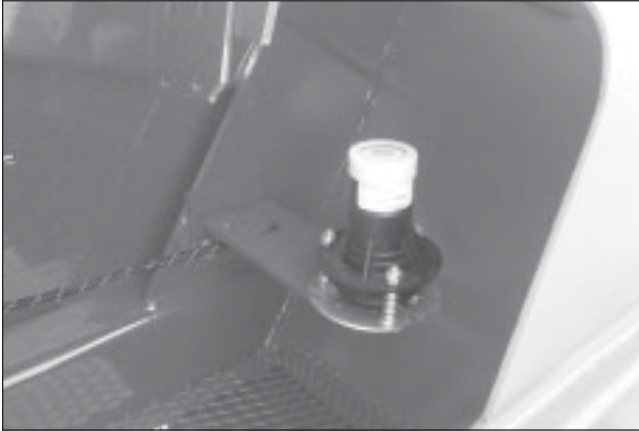

Figure 7.12 – Level Sensor

5. Pull the level sensor to the side as far as possible to activate the tilt alarm.

Warning

The potential for an accident increases when safety devices do not function properly. Death or serious injury can result from such accidents. Do not alter, disable, or override any safety device.

6. If the alarm does not sound, remove the machine from service until the problem is corrected.
7. Lower the main boom.

Flashing Light

If the machine is equipped with an optional flashing light, visually check to see that it flashes. The light should flash when the engine is running.

Sandblast Protection Kit

The optional sandblast protection kit protects the cylinders from abrasion while sandblasting or from paint overspray. Rubber covers protect each cylinder rod as it extends and retracts. The covers prevent sand and paint from damaging the cylinder seals and rod.

Inspect the covers while operating the machine to ensure they are securely fastened and completely cover the cylinder rod. Make sure there are no holes in the covers.

Structures

Visually inspect all weldments and related components. It is important to inspect the fasteners that connect the components.

Weldments

Visually inspect all weldments for abnormal wear, abrasion, or deformation that could cause interference between moving parts.

Inspect the welds on the structural components. Pay particular attention to boom welds. The area to be inspected should be clean and free of dirt and grease. Look for visible cracks in the weld and at the weld to parent material joint. A bright light may be used to provide adequate visibility of the inspection area.

Slide Pads

The main boom has slide pads (refer to Figure 7.13) between the boom sections.

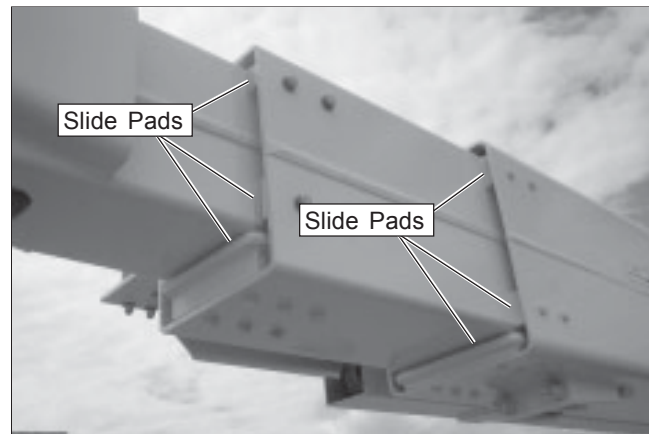

Figure 7.13 – Boom Sections

Use the lower controls to raise the main boom to horizontal. Extend the tip boom about 30 cm (1'). Visually inspect the slide pads to make sure they are in place and are not obviously loose.

Inspect the surface where the pads contact the intermediate and tip booms. The paint must be in place with no signs of bare metal.

Wire Ropes

Visually inspect the wire ropes where they are connected to the outside of the main boom. There is a wire rope connection on the bottom of the tip end of the main boom (refer to Figure 7.14) and also one on the top of the base end of the boom (refer to Figure 7.15).



Figure 7.14 – Bottom of Main Boom at Tip End

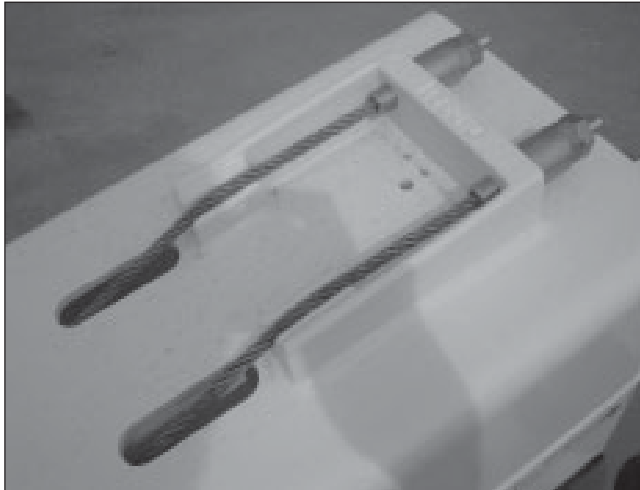

Figure 7.15 – Top of Main Boom at Base End

Also inspect the wire ropes just inside the base end of the main boom (refer to Figure 7.16).



Figure 7.16 – Base End of Main Boom

Fasteners

Visually inspect all fasteners to see that none are missing or loose.

Pay particular attention to all of the bolts, nuts, rollpins, collars, and snap rings that connect the booms and cylinders. They should all be present, tight, and not damaged in any way.

Raise the main boom to access the rotation bearing bolts in the turntable (refer to Figure 7.17).

Inspect the rotation bearing bolts to ensure that none are missing, damaged, or loose.

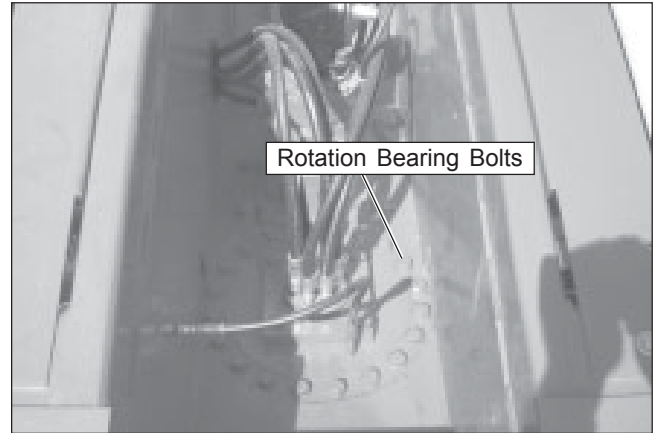

Figure 7.17 – Inside Turntable

Upper Control Station

Inspect the platform and upper controls only if all functions operated properly from the lower controls.

Guardrail System

The guardrail system (refer to Figure 7.18) includes the top rail, mid rail, toeboards and a gravity gate or optional swinging gate.

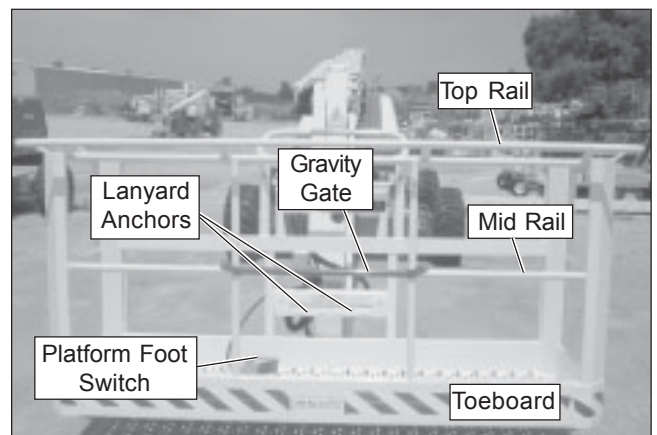

Figure 7.18 – Guardrail System

Inspect all components of the guardrail system. The rails and toeboards must all be in place and free of any damage or deformation. Visually check the rail and toeboard welds for cracks. All bolts and nuts fastening the platform in place must be present and not show any signs of looseness.

Inspect the gravity gate to be sure it is present, is not damaged, and moves freely.

Inspect the optional swinging gate to see that it swings freely, closes firmly, and is not deformed in any way. Make sure the spring closes and secures the gate when the gate is closed.

Lanyard Anchors

There are two lanyard anchors below the upper control panel (refer to Figure 7.18).

Visually inspect the lanyard anchors to make sure they are in place, are not deformed and are securely fastened to the platform.

Operating Controls

Use the following procedure to operate the machine from the upper controls.

1. Turn the battery disconnect switch on.
2. At the lower controls, pull the emergency stop button outward. Insert the key in the control selector and turn the switch to the upper control position.
3. At the upper controls (refer to Figure 7.19), pull the emergency stop button outward.

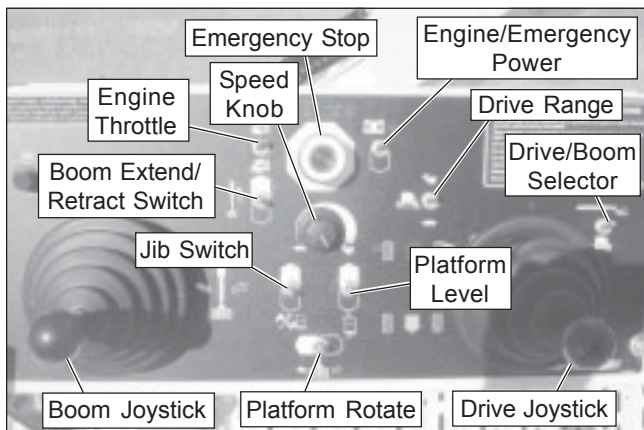

Figure 7.19 – Upper Control Panel Top

4. Turn the master start switch on the front of the upper control panel to start until the engine starts, then release it.
5. Let the engine warm to operating temperature.

Danger

Pinch points may exist between moving components. Death or serious injury will result from becoming trapped between components, buildings, structures, or other obstacles. Make sure all personnel stand clear of the aerial platform while performing the prestart inspection.

6. Place the drive/boom selector switch in the boom position.
7. Test the platform foot switch by moving a boom function switch without stepping on the foot switch. If movement occurs the interlock is not functioning properly. Do not operate the machine until the problem is corrected.

8. Test the operation of each control in both directions from the upper controls.
9. The drive range switch and maximum travel speeds are interlocked through a limit switch on the turntable that senses the main boom position. When the main boom is raised to just below horizontal the machine should travel in low speed only. To operate in high speed the booms must be stowed.

Emergency Stop

Push the emergency stop button in to turn off the engine. The upper control functions should not operate with the emergency stop in this position.

Emergency Power

Pull the emergency stop button up and place the anti-restart master switch in the on position.

Hold the engine/emergency power switch in the emergency power position and step on the platform foot switch to operate the aerial platform from the upper controls using the emergency power system.

Horn

Press the horn button to ensure that it sounds to warn personnel in the area.

Electrical Power Outlet

With the engine running, place the machine/generator control (refer to Figure 7.20) in the generator position to provide electrical power to the outlet at the platform and to the outlet on the end of the generator housing.

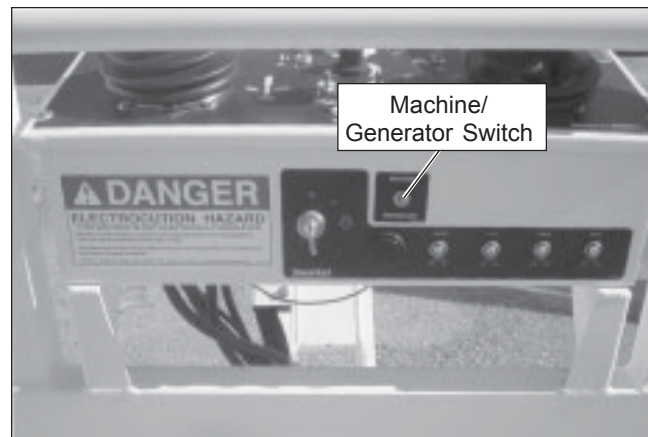

Figure 7.20 – Upper Control Panel Front

Plug an electrical tool into the receptacle at the platform and at the generator and try to operate the tool to verify proper operation of the outlet.

Drive Motion Alarm

The machine may be equipped with an optional drive motion alarm. Drive in both the forward and reverse directions to ensure that the alarm sounds to warn personnel in the area that the aerial platform is in motion.

Driving and Work Lights

The machine may be equipped with driving lights and/or platform working lights. Turn the engine on and use the switch on the back of each light to momentarily turn it on to see that it works.

Platform Control Cover

The machine may be equipped with an optional platform control cover. Inspect the cover to ensure it fits properly over the control panel.

Tow Kit

The machine may be equipped with an optional tow kit. Inspect the tow bar and steering arm to verify the components are present and in working condition.

Placards and Decals

Inspect all safety and operational placards and decals. Make certain they are in place, in good condition, and are legible.

The placards and decals may be cleaned with soap and water, and a soft cloth if the words or pictures cannot be seen.

⚠ Caution

Solvents may contain hazardous ingredients. Follow the manufacturer’s label for proper use and disposal. Wear protective gloves and splash-proof safety glasses when using solvents.

Wet paint overspray may be removed using a natural biodegradable solvent and a soft cloth.

Replace any missing or illegible placards or decals before operating the aerial platform. Placard and decal kits are available from Snorkel dealers.

The safety related placards and decals are illustrated on the following pages.

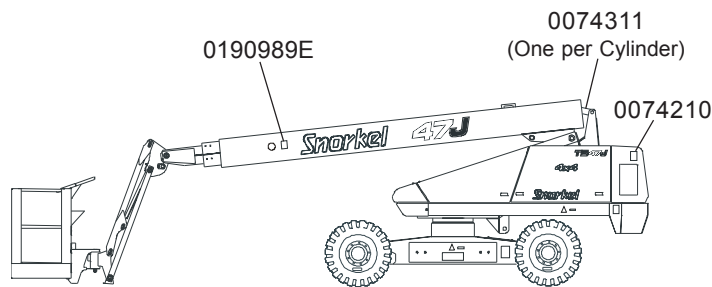

Right Side



0190989E



0074311

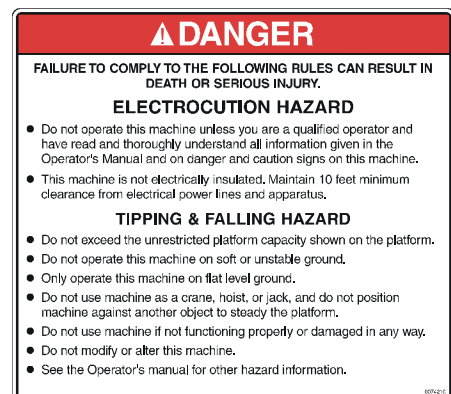

0074210



0162366

This machine is not electrically insulated. Do not operate in proximity to high voltage power lines and parts!

0162336E

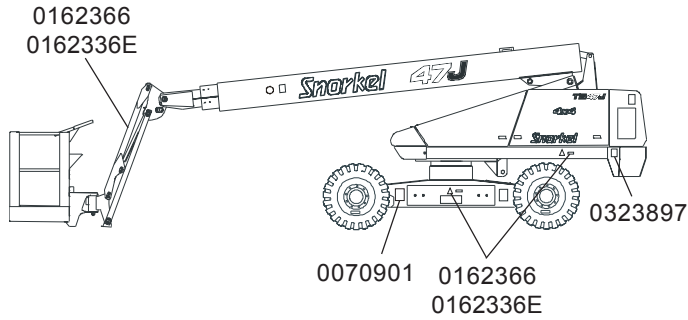

Right Side

Scorkel		SERIAL NUMBER	
MODEL NUMBER		SLOPE SENSOR ALARM SETTING	deg
MONTH / YEAR OF MANUFACTURE		MAXIMUM WHEEL LOAD	lba kg
MAXIMUM MACHINE WEIGHT	lba kg	ENGINE POWERED MODELS ONLY	DRIVE MOTORS BATTERIES
ENGINE POWERED MODELS ONLY	hp kW	MAXIMUM ALLOWABLE MANUAL FORCE (DISC PULL)	lba N
MAXIMUM ALLOWABLE MANUAL FORCE (DISC PULL)	lba N	MAXIMUM WIND SPEED	mph m/s
PLATFORM SIZE	ft cm	MAXIMUM PLATFORM REACH	ft m
MAXIMUM PLATFORM HEIGHT	ft m	MAXIMUM DRIVE HEIGHT	ft m
RATED NUMBER OF OCCUPANTS		UNRESTRICTED PLATFORM CAPACITY	lba kg

CAUTION

Do not remove any weight from this machine. Any weight added must be distributed equally on each axle. Proper stability and axle weights of this machine are based on the platform size shown above.

Also weights with machine in the stowed - travel position.

STEER AXLE	lba	kg
DRIVE AXLE	lba	kg

0070901

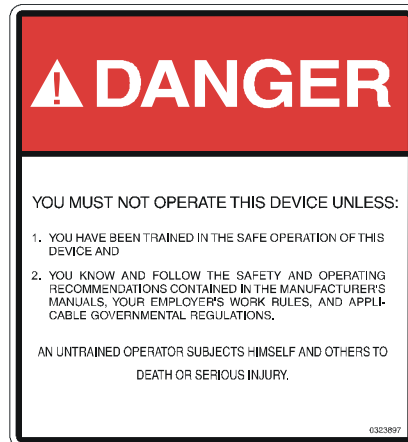

0323897

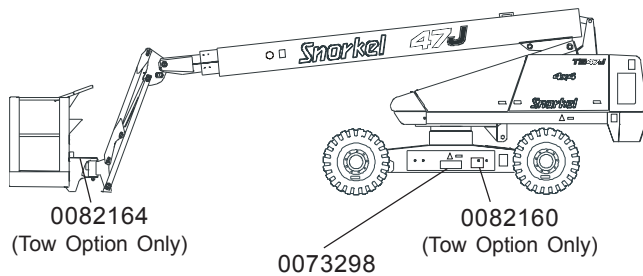

Right Side

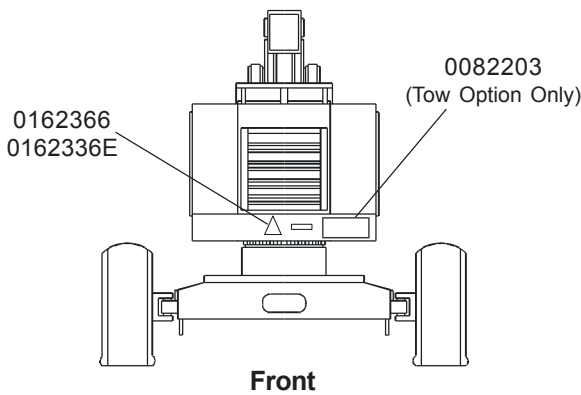

Front



0082164



0073298

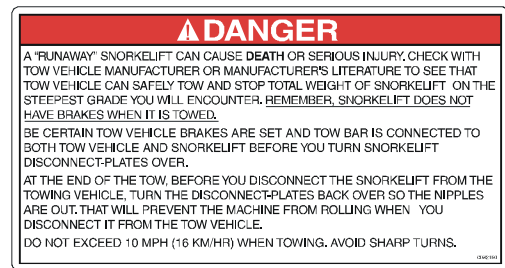

0082160



0162366

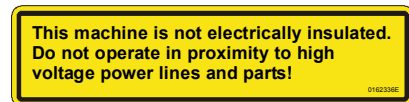

0162336E

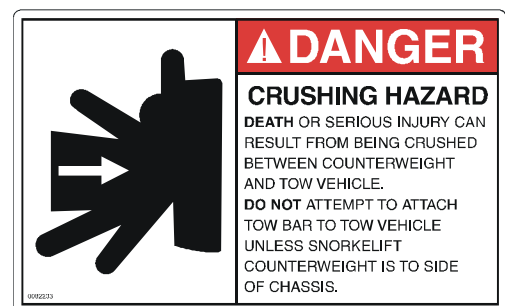

0082203

0151410E
(Cummins Engines Only)

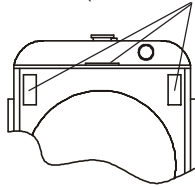

Radiator



0151410E



0162366

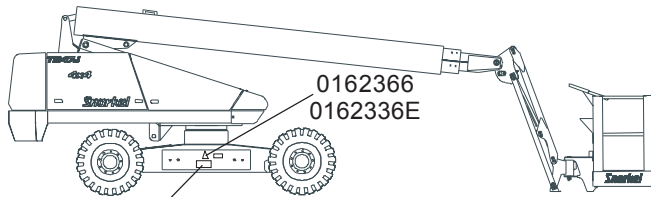

0162366
0162366E

0073298

Left Side

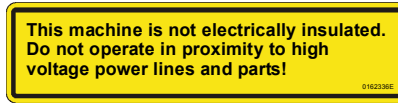

0162366E

0072531

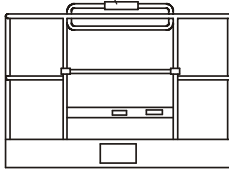

Platform



0073298



0072531

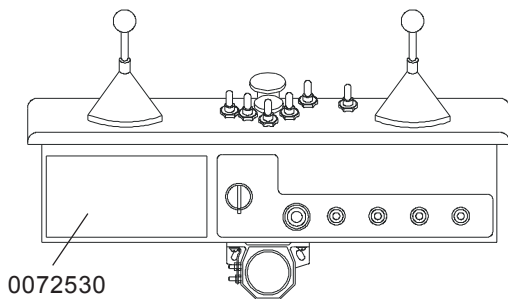

0072530

Upper Control Panel Front

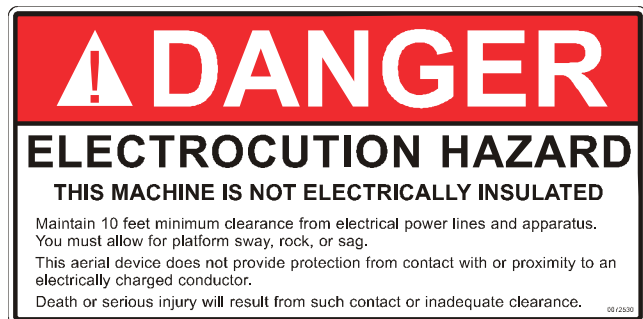

0072530

Prestart Inspection Checklist

Item	Inspect For	Ok
Operator's Manual	In manual holder	
Engine		
Oil level	Between full and add marks	
Coolant	Liquid cooled engines – proper fluid level	
Radiator	Cap tight, good condition and clean	
Air cooled engines	Air intake and fan free of obstructions. Belt in good condition	
Fuel tank and line	Tank full, cap in place and tight/no leaks	
Air filter	Clear indicator	
Charging system	Proper operation	
Cold weather start kit	No damage or deformation	
Electrical System		
Emergency power battery	Condition and charged for proper operation	
Battery fluid level and terminals	Proper level/clean, connectors tight	
Cables and wiring harness	No wear or physical damage	
Hydraulic System		
Fluid level	Between full and add marks	
Fluid filter	Verify operation in the green zone	
Hoses, tubes, and fittings	No leaks	
Cold weather warm-up kit	Proper operation	
Tires and Wheels		
Foam filled	Good condition	
Lower Control Station		
Operating controls	Proper operation	
Emergency stop and emergency power	Shuts off lower controls/proper operation	
Emergency Lowering	Proper operation	
Level Sensor	Sounds tilt alarm	
Flashing Light	Proper operation	
Sandblast Protection Kit	In place and proper operation	
Structures		
Weldments	Welds intact, no damage or deformation	
Slide pads	In place, no damage or deformation	
Fasteners	In place and tight	
Wire ropes	No deformation or broken strands	
Upper Control Station		
Guardrail system and lanyard anchors	Welds intact, no damage or deformation	
Operating controls	Proper operation	
Emergency stop and emergency power	Shuts off upper controls/proper operation	
Horn	Sounds when activated	
Electrical power outlet	Proper operation of outlet and GFCI	
Drive motion alarm	Sounds when aerial platform moves	
Driving and work lights	Proper operation	
Platform control cover	In place and proper operation	
Tow Kit	In place, no damage or deformation	
Placards and Decals	In place and readable	

Chapter 8 – Operation

The aerial platform may be operated from either the lower or upper controls.

Danger

The aerial platform is not electrically insulated. Death or serious injury will result from contact with, or inadequate clearance from, an energized conductor. Do not go closer than the minimum safe approach distance as defined by ANSI or national safety regulations.

Pinch points may exist between moving components. Death or serious injury will result from becoming trapped between components, buildings, structures, or other obstacles. Make sure there is sufficient clearance around the machine before moving the chassis, booms, or platform. Allow sufficient room and time to stop movement to avoid contact with structures or other hazards.

The aerial platform can tip over if it becomes unstable. Death or serious injury will result from a tip-over accident. Operate the aerial platform on a firm, flat, level surface. Avoid travel speeds and/or rough terrain that could cause sudden changes in platform position. Do not drive or position the aerial platform for elevated use near any drop-off, hole, slope, soft or uneven ground, or other tip-over hazard.

The platform rated work load is the total weight of the personnel and equipment that may be lifted in the platform. The work loads are stated on the platform rating placard mounted at the rear of the platform.

Danger

The aerial platform can tip over if it becomes unstable. Death or serious injury will result from a tip-over accident. Do not exceed the capacity values indicated on the platform rating placard.

Capacity values indicate the rated lifting capacity and do not indicate aerial platform stability.

The operator bears ultimate responsibility for ensuring that the aerial platform is properly set up for the particular conditions encountered.

Cold Weather Start-Up

If the ambient temperature is 0°C (32°F) or below, the engine and hydraulic system oil may need to be warmed before operation. Do not operate the engine at more than a fast idle until the engine and hydraulic oil has had a chance to warm. The engine may be equipped with an optional cold weather start kit.

Cold, thick hydraulic oil does not flow well and may cause delay in response to control movement and improper voltage output of the AC generator. Cold oil may also cause cavitation and pump damage. The hydraulic system may be equipped with an optional cold weather warm-up kit.

Engine Cold Weather Start Kit

The optional engine cold weather start kit may be an engine block heater or a manifold air pre-heater. The type of starting assist system depends on the engine manufacturer.

The last two letters of the model number stamped on the serial number placard indicates the engine manufacturer (refer to Figure 8.1). The serial number placard is mounted on the right rear of the chassis.

Last Two Letters of Model Number	Engine Manufacturer	Cold Weather Start System
CU	Cummins	Engine block heater
DZ	Deutz	Manifold air pre-heater

Figure 8.1 – Engine Manufacturer/Start System

Refer to the engine manufacturer below for specific cold weather start-up information for that particular engine type and cold weather start system.

Cummins — Block Heater

Plug the heater cord in eight hours before starting the engine. The heater will warm the engine block to make cold weather starting easier.

Unplug the power cord before starting the engine.

Deutz — Manifold Preheater

At the lower controls, hold the manifold heater switch on for about a minute before turning the master switch to start the engine. A glow plug in the manifold preheats the air to help start the engine. Continue to hold the switch while starting the engine. Do not release the switch until the engine starts.

If the engine does not start within 20 seconds, continue to hold the manifold heater switch and turn the master switch off. Wait for one minute before trying to start the engine again.

Hydraulic System Cold Weather Warm-Up

The hydraulic oil may be warmed by bottoming out the boom extension cylinder. Raise the main boom so it is horizontal and operate the boom retract function while the machine is stowed. With the cylinder bottomed out the oil flow will produce heat to warm the hydraulic oil.

Caution

Not all hydraulic fluid is suitable to use in the hydraulic system. Some have poor lubricating characteristics and can increase component wear. Only use hydraulic fluid as recommended.

Use cold weather hydraulic oil as recommended in the machine General Specifications in temperatures of 0°C (10°F) or below.

Preparing for Operation

Use the following procedure to prepare the aerial platform for operation.

1. Perform a prestart inspection as described in Chapter 7.
2. Place the battery disconnect switch in the on position.
3. Close and latch the doors.
4. Before painting or sandblasting make sure the sandblast protection kit and the platform control cover are properly installed. These options, when used properly will protect the control placards and cylinder rods from paint overspray and abrasion while sandblasting.

Lower Controls

The lower controls override the upper controls. This means that the lower controls can always be used to operate the platform regardless of the position of the upper control emergency stop button.

Boom, turntable, and platform functions may be operated from the lower controls. The lower controls may be used for initial set up of the aerial platform, and for testing and inspection.

Use the following procedure to operate boom, turntable, or platform functions using the lower controls. Refer to Figure 8.2.

1. Pull the emergency stop button (refer to Figure 8.2) outward. Insert the key in the control selector and turn the switch to the lower control position.
2. Press the start button until the engine starts, then release. The engine will not start if the control selector switch is left in the lower control position for 30 seconds or longer before starting the engine. The control selector switch must be turned back to off before the engine will start.
3. Let the engine warm to operating temperature.
4. Hold the ground operation switch up while operating the control toggle switches.
5. Hold the appropriate toggle switch in the desired direction.
6. Release the function toggle switch to stop movement.
7. Place the ground operation switch in the off position when no functions are being operated.

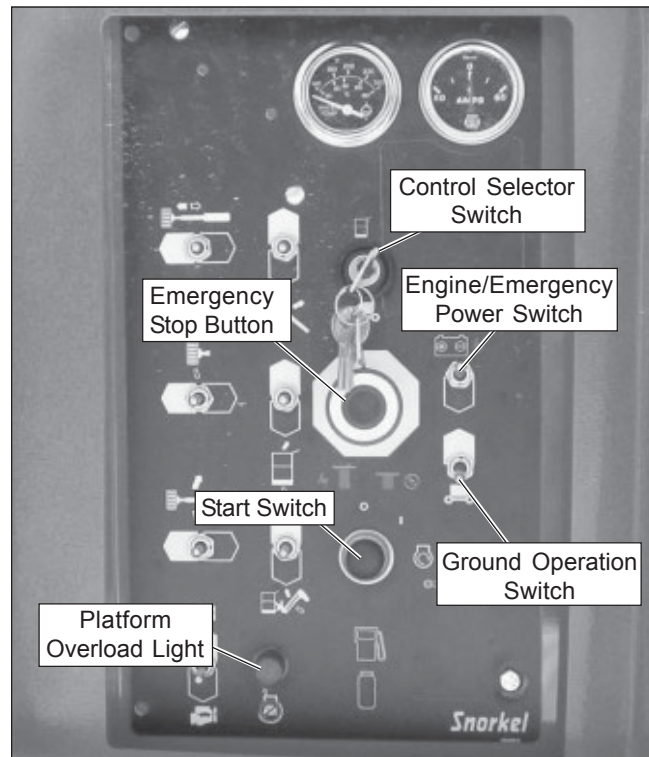

Figure 8.2 – Lower Controls

Upper Controls

The upper controls may be used for driving the aerial platform and positioning the booms and platform while on the job.

Use the following procedure to operate machine functions using the upper controls.

1. At the lower controls, pull the emergency stop button outward. Insert the key in the control selector and turn the switch to the upper control position.
2. Enter the platform and securely close the gate.
3. Attach the fall restraint lanyard to one of the anchor points.
4. Pull the emergency stop outward (refer to Figure 8.3).
5. Turn the anti-restart master switch to on and pause a few seconds while the alarm sounds to alert others that the machine is about to start. Turn the switch to start, then release it to on. The engine will not start if the switch is left in the on position for 30 seconds or longer before turning it to start. The switch must be turned back to off before the engine will start.
6. Let the engine warm to operating temperature.

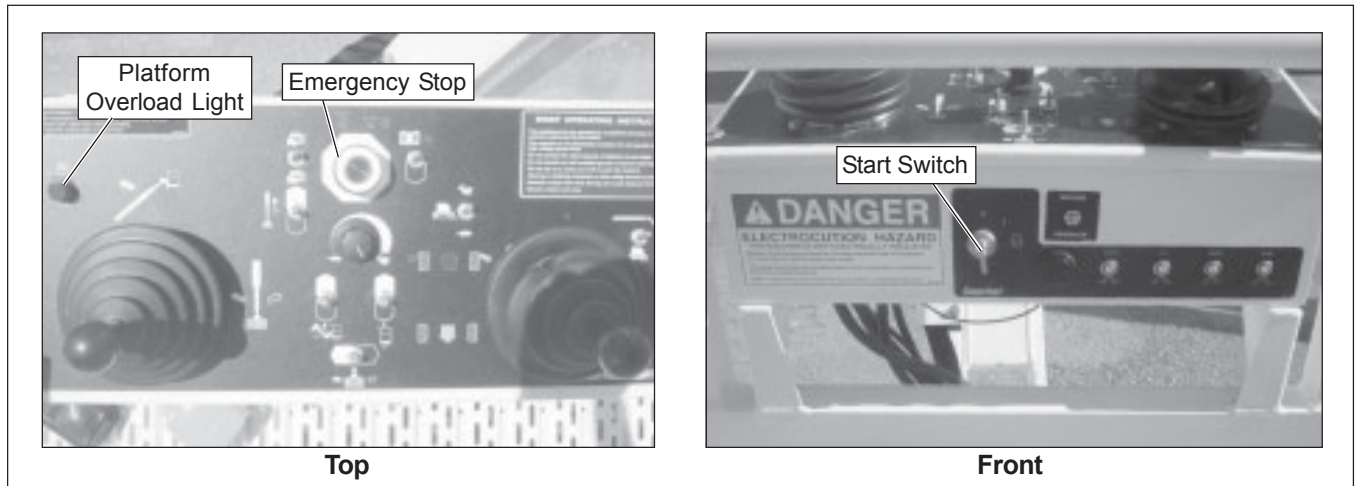

Figure 8.3 – Upper Controls

Boom Operation

Use the following procedure to operate the turntable, boom, or platform functions.

1. Turn the boom speed knob to slow.
2. Step down on the platform foot switch. This switch must be held down to operate the upper controls.

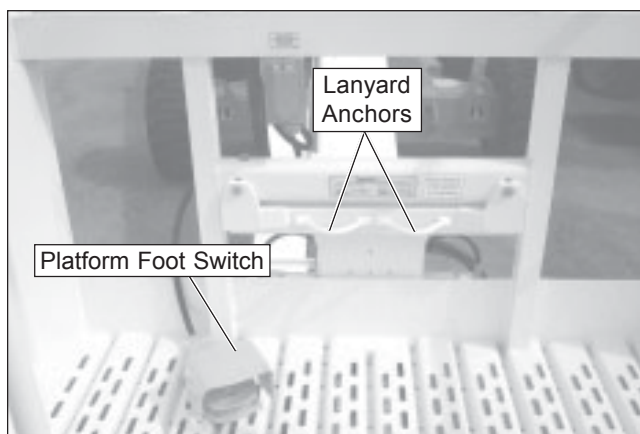

Figure 8.4 – Platform

3. Hold the appropriate control in the desired direction. Always look in the direction of movement.
4. Gradually turn the boom speed knob to control the boom extend, jib, and platform rotate function speed.
5. Releasing the control to its neutral position, or releasing the foot switch will stop movement.

Platform Overload Sensing System

Boom and drive functions are stopped when the platform load reaches or exceeds rated capacity. The horn will sound intermittently and the red light (refer to Figure 8.3) will illuminate when the platform rated work load is exceeded.

The horn will sound and the light will flash until the excess load is removed from the platform. At that time, the boom and drive functions are again operational.

If the overload exceeds rated platform capacity by more than 20 percent, the system will error out, stopping all boom and drive functions. The horn will then sound continuously and the red light will stay illuminated at the upper and lower controls (refer to Figure 8.2).

The horn will sound and the light will stay on until the excess load is removed from the platform and the start switch is turned off and back on, resetting the system. At that time, the boom and drive functions are operational.

⚠ Danger

The aerial platform can tip over if it becomes unstable. Death or serious injury will result from a tip-over accident. Do not exceed the capacity values indicated on the platform rating placard.

The overload sensing system is not active when the machine is being driven with the main boom below horizontal and fully retracted. This allows the machine to be driven without the system sensing an overload due to rough ground conditions.

To eliminate repeated tripping of the system during machine operation, there is a five second delay in machine functions following:

- starting the engine.
- placing the drive/boom selector switch in the boom position when the main boom is below horizontal and fully retracted.
- removing excess load from the platform.

Driving and Steering

Danger

The aerial platform can tip over if it becomes unstable. Death or serious injury will result from a tip-over accident. Do not drive an elevated aerial platform on soft, uneven, or sloping surfaces. Do not drive the machine on grades that exceed 25 percent.

For operation on grades up to 25 percent, it is recommended that the main boom be near horizontal and the jib elevated just enough to provide adequate ground clearance. A 25 percent grade is a 0.76 m (30") vertical rise in 3.05 m (10') horizontal length.

Avoid driving with the platform over the front (steer) end of the chassis. In this position the machine is difficult to control because:

- drive and steer control movements and their resulting machine movements are reversed.
- when driving fast, sudden turns or stops produce more severe reactions to platform occupants.
- more turning space is required to prevent the platform from colliding with obstacles several feet beyond the path of the tires.

Warning

Death or serious injury can result from improperly driving or steering the aerial platform. Read and understand the information in this manual and on the placards and decals on the machine before operating the aerial platform on the job.

The blue and yellow arrows on the chassis indicate the direction the chassis will move when the drive or steer control is moved toward the corresponding color.

When the machine is in the stowed position, with the booms centered between the rear wheels, the direction of drive and steer control movement corresponds with the direction of chassis movement.

When the turntable is rotated from the stowed position, with the booms to either side of or in front of the chassis, the direction of control movement does not correspond with the direction of chassis movement.

To avoid confusion, always drive to the work area or move between work areas with the turntable and booms in the stowed position. After arriving at the work area, the booms may be positioned to the side or the front of the chassis for final positioning. Always look in the direction of movement as indicated by the directional arrows on the chassis.

Use the following procedure to operate the drive and steer functions.

1. Determine the desired drive range for the specific driving conditions.
 - Use high range when traveling across firm, flat, level surfaces. High range can only be activated when the booms are stowed. High range is for high speed, low torque operation.
 - Use low range for driving on loading ramps or other steep grades and when safety considerations demand slow deliberate machine movement. Low range is for low speed, high torque operation.
 2. Place the drive/boom selector switch in the drive position.
 3. Step down on the platform foot switch.
 4. Push the drive joystick forward to move the chassis forward, the direction of the blue arrow. Pull the joystick backward to move the chassis backward, the direction of the yellow arrow. The drive speed is proportional to the joystick position.
 5. To stop drive motion, return the joystick to neutral.
 6. Push the drive joystick to the right to steer to the right, the direction of the yellow arrow. Push the joystick to the left to steer to the left, the direction of the blue arrow.
- Note*
The steering wheels are not self-centering. Set the steering wheels straight ahead after completing a turn.
7. After driving to the desired location, release the foot switch, or push the emergency stop button to apply the parking brakes.

Drive Speeds

The drive speed is proportional to the joystick position. The farther the joystick is moved, the faster the travel speed.

Always slow down and shift the drive system to low range before traveling over rough terrain or any sloped surface.

Drive speed ranges are interlocked through a limit switch that senses the main boom position. When the boom is elevated, only the slowest drive speed will work regardless of the drive range switch position.

Warning

The potential for an accident increases when safety devices do not function properly. Death or serious injury can result from such accidents. Do not alter, disable, or override any safety device.

Do not use the aerial platform if it drives faster than 1.6 km/h (1.0 mile per hour) [13.4 m (44 feet) in 30 seconds] when the booms are elevated from the stowed position.

Motion Warning Alarm

The motion warning alarm sounds loud intermittent beeps when the drive joystick is in the forward or reverse position.

Four Wheel Drive

The machine may be equipped with a four wheel drive system. This system operates full time and requires no action by the operator.

Four wheel drive machines have a “4x4” decal on each side of the chassis and all four of the wheel hubs are drive hubs and look the same.

AC Generator

The generator supplies power to the electrical outlet only when the engine is running and the machine is stationary. The machine functions will not operate when the machine/generator selector switch is in the generator position.

⚠ Caution

Cold hydraulic oil does not flow well and may produce improper generator output voltage. Improper outlet voltage can damage some electrical power tools and equipment. Warm the hydraulic oil before operating the generator.

Do not operate the generator unless the hydraulic oil temperature is at least 38°C (100°F). Refer to Cold Weather Start-Up for a hydraulic oil warm-up procedure.

Start the engine and place the machine/generator selector switch (refer to Figure 8.5) in the generator position.

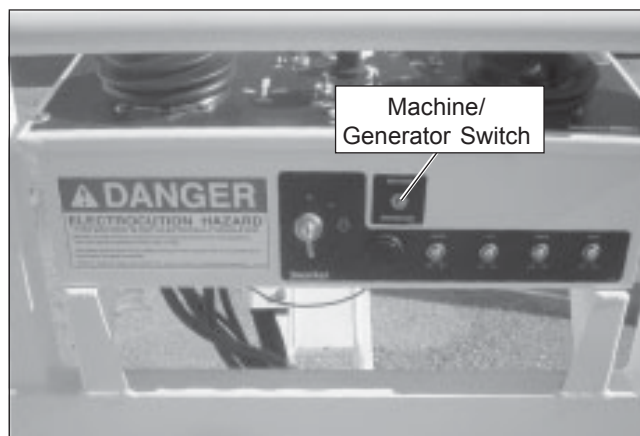

Figure 8.5 – Upper Control Panel Front

The engine will run at high idle while the generator is operating. The generator will continue to operate as long as the engine is running and the switch is in the generator position.

Air Line

The optional air line may be used to conduct air for tool operation at the platform. The input connector is at the rear of the chassis and the output connector is at the platform on the rotator guard. The maximum working pressure of the line is 1,723 kPa (250 psi).

The air line may be used to conduct fluids such as water or antifreeze. Contact Snorkel for compatibility information before using the air line to conduct other fluids.

⚠ Caution

Fluid in the air line can damage some air tools or freeze and damage the line. Drain and blow out the air line after using it to conduct fluids.

Use the following procedure to drain the air line.

1. Close the input connector on the chassis.
2. Open the output connector at the platform.
3. Raise the boom slightly above horizontal.
4. Open the input connector on the chassis.
5. Allow the fluid to drain from the line.
6. Lower the boom and close both connections.

Driving Lights

The optional driving lights are for use in dimly lit areas and are not intended for driving on public roadways. There are two headlights at the front of the chassis and two blinking taillights at the rear of the chassis.

The lights are operational when the battery disconnect switch and the master switch are turned on.

Note

Working with the driving or platform work lights on, while the engine is off, can discharge the batteries enough that the engine will not start or the emergency power system will not operate. If the engine cannot be left running while the lights are on, start and run the engine for at least 15 minutes each hour.

Platform Work Lights

The optional platform work lights (refer to Figure 8.6) are located on the top rail of the platform. The direction a light points can be adjusted by using two 1/2" wrenches to loosen the clamp below the light.

The lights are operational when the upper controls emergency stop button is pulled up and the anti-restart master switch is turned on.

The engine speed increases to high idle when the platform work lights are turned on.

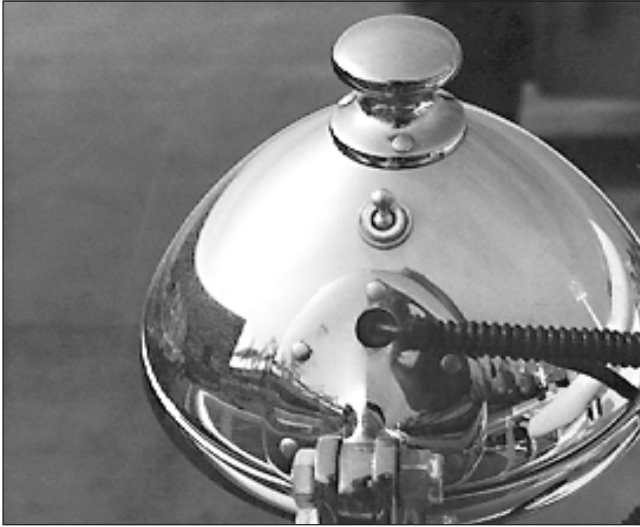

Figure 8.6 – Platform Work Lights

Chapter 9 – Stowing and Transporting

To prevent unauthorized use and damage, properly stow the aerial platform at the end of each work day. It must also be properly stowed while transporting.

Stowing

The properly stowed position is shown in Figure 9.1.

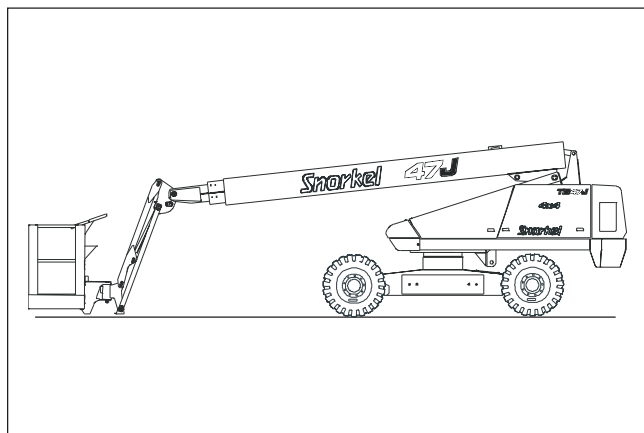

Figure 9.1 – Stowed Position

Use the following procedure to properly stow the aerial platform.

1. Rotate the platform so it is perpendicular to the end of the boom.
2. Fully retract the booms and then lower the main boom until the foot on the jib is near the ground to allow for exiting the platform.
3. Center the booms between the rear wheels.
4. If the engine has just been under load and is hot, set the throttle switch to low and let the engine idle for five minutes.
5. Turn the start switch off and place the platform control box cover over the upper controls if the machine is equipped with that option.
6. Push the lower controls emergency stop button inward. Turn the control selector switch off and remove the key.
7. Turn the battery disconnect switch off.
8. Close and latch the cowling doors.

Tucked Stow

The platform may be tucked underneath the main boom to reduce the overall length of the machine when it is stowed for an extended period of time or for transporting.

The tucked stow position is shown in Figure 9.2.

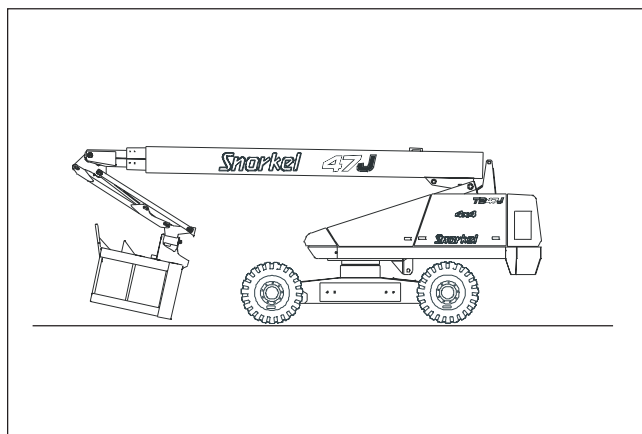

Figure 9.2 – Tucked Stowed Position

Use the following procedure to stow the platform in the tucked position using the lower controls.

1. Rotate the platform so it is perpendicular to the end of the boom.
2. Fully retract the tip boom and then raise the main boom slightly above horizontal.
3. Operate the platform level switch in the down position to tuck the platform beneath the main boom. Watch the position of the platform to make sure it does not contact the ground surface. It may be necessary to slightly raise the main boom to prevent the platform from contacting the ground.
4. Center the booms between the rear wheels.
5. If the engine has just been under load and is hot, set the throttle switch to low and let the engine idle for five minutes.
6. Turn the start switch off and place the platform control box cover over the upper controls if the machine is equipped with that option.
7. Push the lower controls emergency stop button inward. Turn the control selector switch off and remove the key.
8. Turn the battery disconnect switch off.
9. Close and latch the cowling doors.

Transporting

The aerial platform may be moved on a transport vehicle. Depending on the particular situation, the aerial platform may be driven, winched, or hoisted onto a vehicle such as a truck or trailer. Driving is the preferred method.

⚠ Danger

The aerial platform can tip over if it becomes unstable. Death or serious injury will result from a tip-over accident. Do not drive on ramps that exceed 25 percent grade, or where conditions of the ramp could cause driving to be hazardous.

Drive the aerial platform onto the transport vehicle if the ramp incline is within the 25 percent grade capability of the aerial platform.

A 25 percent grade is a 0.76 m (30") vertical rise in 3.05 m (10') horizontal length.

Use a winch to load and unload the aerial platform on ramps that exceed 25 percent grade. A winch may also be used when conditions of the ramp could cause driving to be hazardous.

The equipment used to load, unload, and transport the aerial platform must have adequate capacity. Refer to Chapter 2 to determine the approximate weight of the aerial platform.

The user assumes all responsibility for choosing the proper method of transportation, and the proper selection and use of transportation and tie-down devices, making sure the equipment used is capable of supporting the weight of the aerial platform and that all manufacturer's instructions and warnings, regulations and safety rules of their employer, the DOT and/or any other state or federal law are followed.

Driving

Use the following procedure to drive the aerial platform onto the transport vehicle.

1. Locate the transport vehicle so it is in a straight line with the loading ramp.
2. Chock the vehicle wheels so it cannot roll away from the ramp while the machine is loaded.
3. Remove any unnecessary tools, materials, or other loose objects from the platform.
4. Drive the machine to the foot of the loading ramp with the front wheels nearest the ramp. Make sure the machine is centered with the ramps and that the steering wheels are straight.
5. Rotate the platform so it is perpendicular to the boom.
6. Retract the tip boom and raise the main boom so it is horizontal.
7. Rotate the turntable slightly to the side so you can see the front wheels.
8. Verify that the machine wheels, loading ramps, and transport vehicle are aligned.

⚠ Danger

The aerial platform can tip over if it becomes unstable. Death or serious injury will result from a tip-over accident. Set the drive range to low before driving up or down a grade.

9. Place the drive range switch in the low position.
10. Drive the aerial platform onto the transport vehicle in a straight line through the grade transitions with minimal turning.
11. Rotate the turntable to align the main boom between the rear wheels.
12. When driving down the ramp, always back the machine with the platform on the downhill side only.

Winching

Use the following procedure to winch the aerial platform onto the transport vehicle.

1. Locate the transport vehicle so the aerial platform will not roll forward after it is loaded.
2. Remove any unnecessary tools, materials, or other loose objects from the platform.
3. Drive the machine to the foot of the loading ramp with the front wheels nearest the ramp. Make sure the machine is centered with the ramps and that the steering wheels are straight.
4. Properly stow the aerial platform.
5. Attach the winch to the tie-down lugs (refer to Figure 9.3) on the front of the chassis.

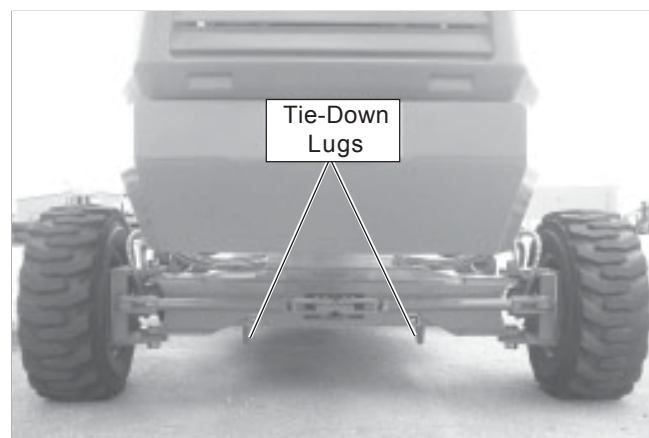

Figure 9.3 – Front Tie-Down Lugs

6. At each drive wheel, remove the two bolts from the disconnect plate (refer to Figure 9.4). Turn the plate over so the nipple points inward. Reinstall the two bolts.

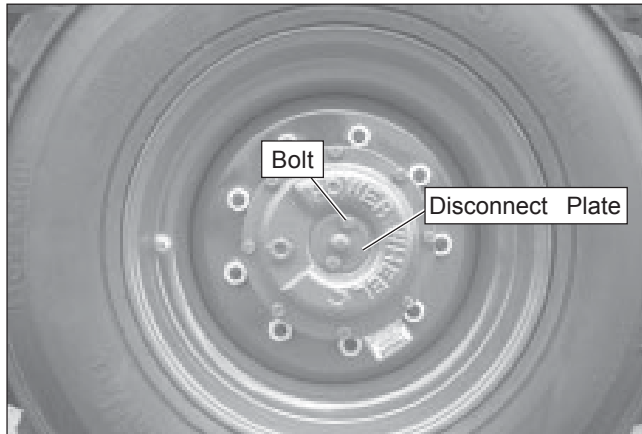

Figure 9.4 – Drive Wheel

7. Use the winch to position the aerial platform on the transport vehicle.

⚠ Warning

The aerial platform is free to move when the drive hubs are disabled. Death or serious injury can result. Re-enable the drive hubs before operating the aerial platform.

8. At each drive wheel, remove the two bolts and return the plate to its original position as shown in Figure 9.4.
9. Start the engine and operate the drive control in forward and reverse several times to engage the drive hubs.

Hoisting

Use a four point sling arrangement attached to the lifting lugs when hoisting the aerial platform. Machine damage can occur if the sling is attached to the booms, turntable, or platform.

⚠ Warning

The potential for an accident increases when the aerial platform is lifted using improper equipment and/or lifting techniques. Death or serious injury can result from such accidents. Use proper equipment and lifting techniques when lifting the aerial platform.

Know the weight of the aerial platform and the capacity of the lifting devices before hoisting. Lifting devices include the hoist or crane, chains, straps, cables, hooks, sheaves, shackles, slings, and other hardware used to support the machine. The gross vehicle weight is stamped on the serial number placard and is listed in Chapter 2.

The user assumes all responsibility for making sure the equipment used is capable of supporting the weight of the aerial platform and that all manufacturer's instructions and warnings, regulations and safety rules of their employer and/or any state or federal law are followed.

Use the following procedure to hoist the aerial platform onto the transport vehicle.

1. Properly stow the aerial platform.

Note

The lifting lugs at the rear of the chassis are farther apart than those at the front. Rotating the turntable 180° will place the counterweight at the rear of the chassis. This will reduce the number of spreader bars needed by one and sometimes two.

2. Inspect the lifting lugs (refer to Figure 9.5) to make sure they are free of cracks, rust, and are in good condition. Have any damage repaired by a qualified service technician before attempting to hoist the machine.

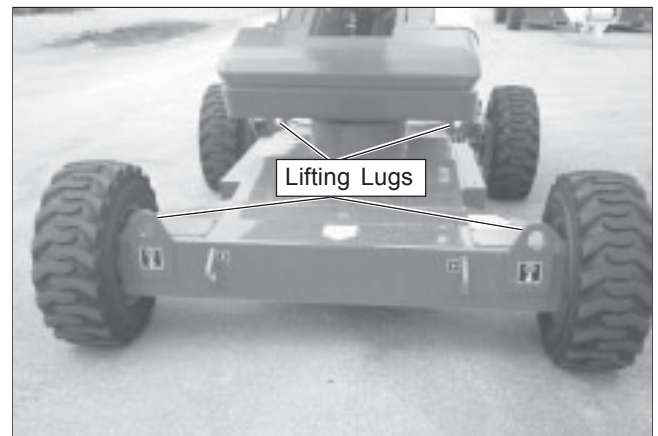

Figure 9.5 – Lifting Lugs

3. Remove all personnel, tools, materials, or other loose objects from the platform.
4. Connect the chains or straps to the lifting lugs using bolted shackles. Hooks that fit properly in the lugs and that have latching mechanisms to prevent them from falling out under a slack line condition may also be used.

Do not run the sling cable through the lifting lugs. Cable damage and/or failure can result from the cable contacting the sharp corners of the lug. There is no effective way of putting a corner protector in the hole of the lifting lug.

5. Use spreader bars of sufficient length to keep the chains, straps, or cables from contacting the turntable or booms. When using cables, use rigid corner protectors at any point where the cable contacts sharp corners to prevent damaging the cable. Careful rigging of the spreaders is required to prevent machine damage.
6. Adjust the length of each chain or strap so the aerial platform remains level when raised off the ground.

7. Use the hoist or crane to carefully raise and position the aerial platform onto the transport vehicle.

Securing for Transport

Use the following procedure to secure the aerial platform on the transport vehicle.

1. Chock the wheels.
2. Raise the main boom about 0.3 m (1').
3. Place a wood block under the jib foot. Lower the platform so the foot rests on the wood block.
4. Remove all personnel, tools, materials, or other loose objects from the platform.
5. Turn the start switch off and place the platform control box cover over the upper controls if the machine is equipped with that option.
6. Push the lower controls emergency stop button inward. Turn the control selector switch off and remove the key.
7. Turn the battery disconnect switch off.
8. Close and latch the cowling doors.
9. Use wire-ties to fasten the platform gate to the guardrails to prevent the gate from bouncing. Also, use wire-ties to fasten the platform foot switch to the platform floor.

10. Use a nylon strap to securely fasten the platform against the wood block. Thread the strap over the toeboard as shown in Figure 9.6.



Figure 9.6 – Platform

Caution

Ratchets, winches, and come-alongs can produce enough force to damage machine components. Do not over tighten the straps or chains when securing the aerial platform to the transport vehicle.

11. Use chains or straps to securely fasten the aerial platform to the transport vehicle using the tie-down lugs as attachment points. Proper tie-down and hauling are the responsibility of the carrier.

Chapter 10 – Emergency Operation

If the main hydraulic system fails, the aerial platform may be lowered and stowed using the emergency power system. The main boom may be lowered using the emergency lowering knob. The machine may be towed if the drive system fails. Refer to Emergency Power System, Emergency Lowering, or Towing for the appropriate procedure.

Emergency Power System

The emergency power system can be used to operate the machine from the lower or upper controls.

⚠ Caution

The emergency power system is for emergency lowering and stowing only. The length of time the pump can be operated depends on the capacity of the battery. Do not use this system for normal operation.

Only use the emergency power system if the main power system fails.

Lower Controls

Use the following procedure to operate the machine using the emergency power system from the lower controls.

1. Place the battery disconnect switch in the on position (refer to Figure 10.1).

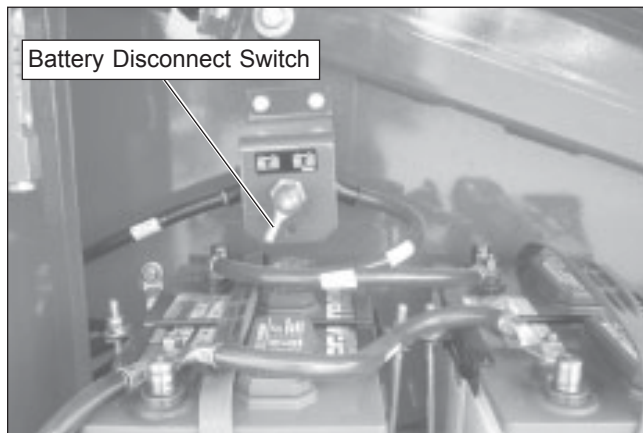

Figure 10.1 – Battery Disconnect Switch

2. Place the key in the control selector switch (refer to Figure 10.2) and turn the control switch to the lower control position.
3. Pull the emergency stop button outward.
4. Hold the ground operation switch in the on position while holding the engine/emergency power switch down in the emergency power position.

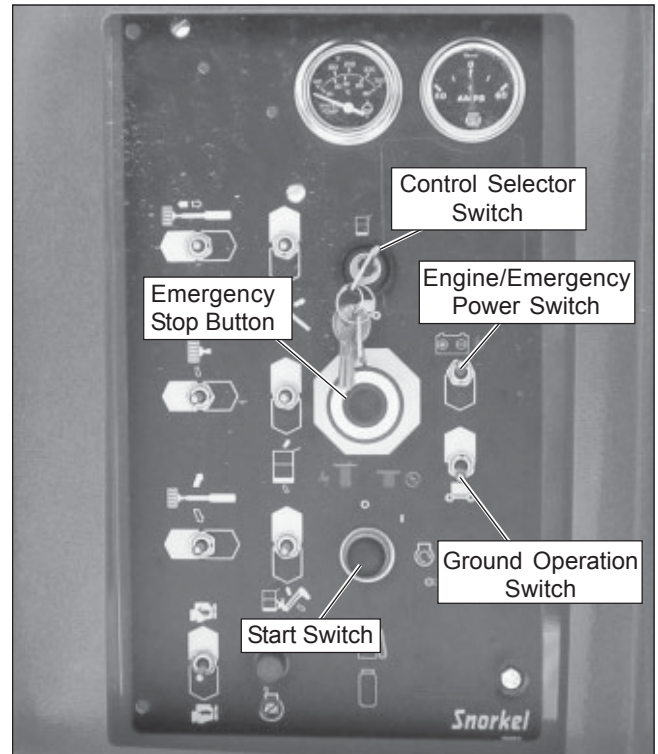

Figure 10.2 – Lower Controls

5. Hold the appropriate function toggle switch in the desired direction.

Upper Controls

For the upper controls to be operational:

- the battery disconnect switch must be in the on position.
- the emergency stop button at the lower controls must be in the on position.
- the controls selector switch at the lower controls must be in the upper controls position.

Use the following procedure to operate the machine using the emergency power system from the upper controls.

1. Pull the emergency stop button outward (refer to Figure 10.3).
2. Turn the start switch on.
3. Place the drive/boom selector switch in the appropriate position.
4. Step down on the platform foot switch (refer to Figure 10.4).

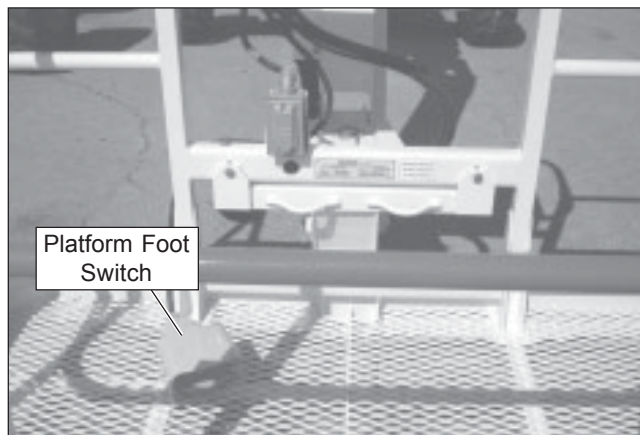
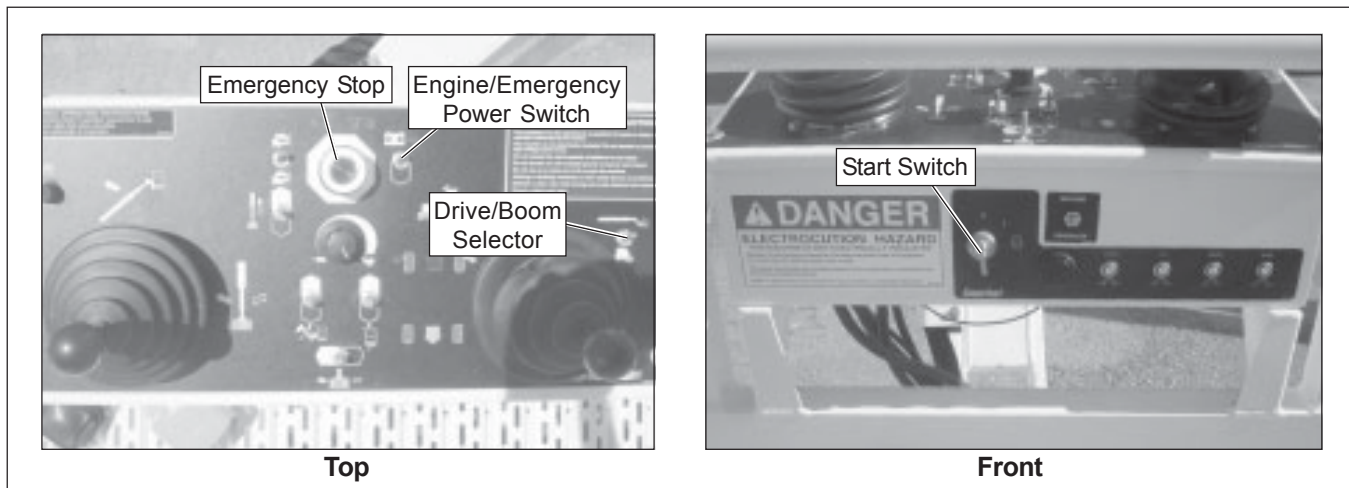

1. Slowly turn the knob (refer to Figure 10.5) to open the bleed down valve. Control the rate of descent by turning the knob.



5. Hold the engine/emergency power switch in the emergency power position.
6. Hold the appropriate function toggle switch in the desired direction.

Emergency Lowering

The main boom can be lowered in an emergency using the emergency lowering knob at the base of the lift cylinder. The emergency lowering knob allows the main boom to be lowered only. Only use this method if the engine will not start and the emergency power system will not work.

⚠ Danger

Pinch points exist between boom components and between the booms and turntable. Death or serious injury will result if the booms or platform lowers onto personnel. Make sure all personnel stand clear while lowering the booms.

Use the following procedure to manually lower the main boom.

⚠ Warning

The potential for an accident increases when safety devices do not function properly. Death or serious injury can result from such accidents. Fully close the emergency lowering knob before operating the aerial platform.

2. Turn the knob to close the cylinder bleed down valve.

Towing

The aerial platform may be towed at slow speeds using the optional tow kit. The tow vehicle must have sufficient capacity to safely tow and stop itself and the aerial platform on the steepest grade and type of surface that may be encountered. Refer to Chapter 2 for the gross vehicle weight of the aerial platform.

⚠ Warning

The aerial platform is free to move when the drive hubs are disabled. Death or serious injury can result. Securely fasten the tow vehicle to the aerial platform before disabling the drive hubs.

Use the following procedure to manually disengage the drive hubs and tow the machine.

1. With the machine in the stowed position, remove the tow bar from the storage cradles at the rear of the chassis and lay the tow bar near the front of the chassis.

⚠ Danger

Pinch points may exist between machine components. Death or serious injury will result from becoming trapped between components. Do not attach the tow bar to the tow vehicle until the counterweight is to the side of the chassis.

2. Rotate the turntable, until the counterweight is to the side of the chassis, to allow room to attach the tow bar.
3. Attach the tow bar to the front steering arm with the tow pin and snap pin.
4. Attach the tow bar to the tow vehicle.
5. Rotate the turntable so the counterweight is back at the front of the chassis. Raise the platform about 1 m (3') above the ground.
6. Shut the engine off and turn the battery disconnect switch off.
7. At each drive wheel, remove the two bolts from the disconnect plate (refer to Figure 10.6). Turn the plate over so the nipple points inward. Reinstall the two bolts.

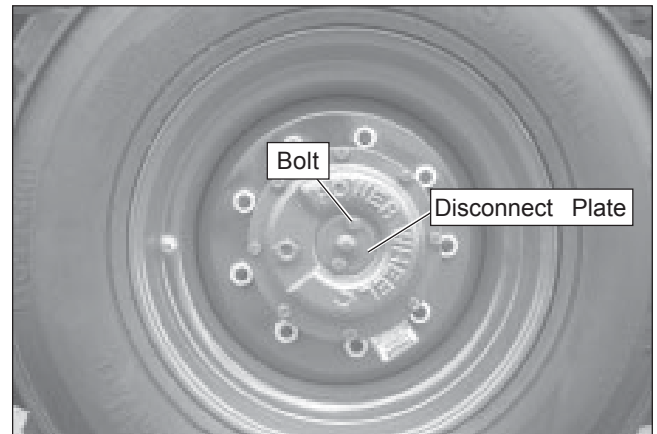

Figure 10.6 – Drive Wheel

8. Pull the steering float valve knob out. The knob is located behind the rear door on the right side of the turntable next to the fuel tank.
9. Do not exceed 16 km/h (10 mph) when towing. Use caution when traveling around a curve or when turning a corner. If the tow bar contacts the chassis the steering mechanism might be damaged or the tow vehicle and the aerial platform could jackknife.

⚠ Warning

The aerial platform is free to move when the drive hubs are disabled. Death or serious injury can result. Re-enable the drive hubs before operating the aerial platform.

10. Push the steering float valve knob in.
11. At each drive wheel, remove the two bolts and return the plate to its original position as shown in Figure 10.6.
12. Unfasten the tow vehicle from the machine and replace the tow bar on the storage cradles.
13. Verify that the drive system operates properly.

Chapter 11 – Troubleshooting

The troubleshooting chart may be used to locate and eliminate situations where machine operation may be interrupted. If the problem cannot be corrected with the

action listed, stow the machine and remove it from service. Repairs must be made by qualified maintenance personnel.

Troubleshooting Chart

Symptom	Possible Cause	Corrective Action
Engine will not start from lower or upper controls.	Out of fuel. The engine will crank, but will not start.	Add correct type of fuel. Try starting the engine for 20 seconds and then let the starter motor cool for 60 seconds. Repeat as necessary.
	Engine is cold.	Cummins engine – plug the block heater in eight hours before starting the engine. Deutz engine – hold the manifold heater switch on for about a minute before starting the engine. Hold the switch on until the engine starts.
	High engine temperature.	Let engine cool. Do not restart the engine until the cause of overheating has been corrected.
	Low oil pressure.	Do not try to start the engine until the cause of low oil pressure has been corrected. The engine can be restarted with low oil pressure, but it will only run a few seconds before it shuts off again.
Engine will not start from lower controls.	Switches are set wrong. The engine will not crank.	Turn the battery disconnect switch on and then at the lower controls: <ul style="list-style-type: none"> • Turn the control selector switch off. • Pull the emergency stop button outward. • Place the control selector switch in the lower control position. • Wait for 5 seconds and then press the start switch to start.
	The control selector switch was left in the lower control position for 30 seconds or longer before starting the engine.	Press the start button within 30 seconds of placing the control selector in the lower controls position.
	The main system circuit breaker on the wiring box has tripped. The engine will not crank.	Push the main system circuit breaker button back in. If the button pops back out, refer the problem to a qualified service technician.

Symptom	Possible Cause	Corrective Action
Engine will not start from upper controls.	Switches are set wrong. The engine will not crank.	<p>Turn the battery disconnect switch on and then at the lower controls:</p> <ul style="list-style-type: none"> • Turn the control selector switch off. • Pull the emergency stop button outward. • Place the control selector switch in the upper control position. <p>From the upper controls:</p> <ul style="list-style-type: none"> • Turn the start switch off. • Pull the emergency stop button outward. • Place the start switch in the on position for 5 seconds and the then turn the switch to start.
	Platform foot switch is activated.	Do not step on foot switch while starting the engine.
	The start switch was left in the on position for 30 seconds or longer before turning it to start.	Turn the start switch back to off, then to start within 30 seconds.
	The main system circuit breaker on the upper control panel or wiring box has tripped. The engine will not crank.	Push the main system circuit breaker button back in. If the button pops back out, refer the problem to a qualified service technician.
Engine dies when the control selector switch at the lower controls is placed in the platform position.	Upper controls are not set-up properly.	At the upper controls, pull the emergency stop button upward and turn the anti-restart master switch on.
Constant tone alarm sounds while the engine is running.	High engine temperature.	Lower the platform and reduce the engine speed to idle for five minutes. Turn the engine off and let it cool. Do not restart the engine until the cause of overheating has been corrected.
	Low oil pressure.	Lower the platform and turn the engine off. Do not restart the engine until the cause of low oil pressure has been corrected.
	No alternator current/broken fan belt.	Turn the engine off. Do not restart the engine until the cause of no alternator current has been corrected or the fan belt is replaced.

Symptom	Possible Cause	Corrective Action
Constant tone alarm sounds and engine shuts off.	High engine temperature.	Let the engine cool. Do not restart the engine until the cause of overheating has been corrected.
	Low oil pressure.	Do not restart the engine until the cause of low oil pressure has been corrected. The engine can be restarted with low oil pressure, but it will only run a few seconds before it shuts off again.
Horn is sounding intermittently and the overload light is flashing.	The load in the platform is greater than the rated capacity.	Remove load from the platform until the alarms stop.
Horn is sounding constantly and the overload light is on.	The platform overload system has an error.	Remove load until at or below rated capacity. Cycle machine power off, then on. If alarm continues, system may need recalibration.
Platform overload sense system does not work while operating the upper controls.	Drive/boom selector switch is in the drive position and the main boom is below horizontal.	Normal operation. The platform overload system is inactive while driving with the boom below horizontal to prevent accidental activation due to rough terrain.
	System needs calibration.	Refer the problem to a qualified service technician.
Boom functions do not immediately return when switching from drive to boom. There is a delay in boom functions after switching the drive/boom switch to the boom position after driving the machine with the boom below horizontal.	Platform overload system delay.	Normal operation. The system includes a 5 second delay to eliminate rapid stop and restart of movements if the overload system trips during operation.
All functions stop working.	Low fluid level in reservoir.	Check fluid level. Add correct type of fluid if necessary.
	Engine or pump failure.	Manually stow the machine using the emergency power system or the emergency lowering knob.
	Circuit breaker is tripped.	Push circuit breaker button in to reset.
	Electrical system malfunction.	Manually lower the boom using the emergency lowering knob.
	Platform overload sensor is tripped.	If horn is sounding and red overload light is on or blinking, remove weight from the platform until the load is at or below rated capacity.
Lower controls do not work.	Battery disconnect switch turned off.	Place switch in the on position.
	Emergency stop switch at lower controls is pushed in to the off position.	Pull the emergency stop button out to the on position.

Symptom	Possible Cause	Corrective Action
Lower controls do not work.	Control selector switch is in the platform position.	Place the switch in the lower control position.
	Ground operation switch not held in the on position.	Hold the ground operation switch in the on position while operating the control toggle switches.
	Platform overload sensor is tripped.	If horn is sounding and red overload light is on or blinking, remove weight from the platform until the load is at or below rated capacity.
Upper controls do not work.	Battery disconnect switch turned off.	Place switch in the on position.
	Emergency stop switch at lower and upper controls is in the off position.	Place the emergency stop in the on position.
	Control selector switch at lower controls is in the lower control position.	Place switch in the upper control position.
	Platform foot switch not engaged.	Step down on platform foot switch while operating controls.
	Platform overload sensor is tripped.	If horn is sounding and red overload light is on or blinking, remove weight from the platform until the load is at or below rated capacity.
Boom functions do not work.	The drive/boom switch is in the drive position.	Place the switch in the boom position.
Boom and drive functions seem sluggish.	Hydraulic oil is cold and thick.	Use cold weather hydraulic oil as recommended for weather conditions. Warm oil before operating the machine.
Boom jerks while it is extended.	Wire ropes are loose.	Refer the problem to a qualified service technician.
Tip boom extend/retract, jib, and platform rotate functions do not work from the upper controls.	Boom speed knob set too slow.	Turn knob toward fast.
Booms drift down.	The emergency lowering valve is open.	Turn the emergency lowering knob to close the valve.
	Hydraulic system malfunction.	Stow the machine and do not operate until repairs are made.

Symptom	Possible Cause	Corrective Action
Drive functions do not work.	The drive/boom switch is in the boom position.	Place the switch in the drive position.
	Machine on too steep a grade.	Lower the booms and drive to a level surface.
	Drive hubs are disengaged.	Turn drive wheel disconnect plates around so nipples point outward.
	Low hydraulic system pressure.	Stow the machine and do not operate until repairs are made.
	Platform overload sensor is tripped.	If horn is sounding and red overload light is on or blinking, remove weight from the platform until the load is at or below rated capacity.
Wheels will not turn when winching.	Drive hubs are engaged.	Turn drive wheel disconnect plates around so nipples point inward.
Only slow drive speed works.	The booms are elevated. High range not selected.	Completely lower the booms. Place the drive range switch in the high position.
Steer wheels do not turn right or left on machines with tow option.	Tow kit steering float valve is open.	Close the steering float valve.
Tilt alarm does not work.	Booms are stowed.	Normal operation. The tilt alarm is not active until the booms are elevated.
Circuit breaker will not reset.	Electrical circuit has not had time to cool.	Wait a minute or two for circuit to cool, then push circuit breaker button in to reset.
	Electrical system malfunction.	Do not operate machine until repairs are made.
Electrical outlet does not work.	Power supply not plugged in.	Plug the power cord into the power-input connector on the generator.
	Machine/generator switch not in the generator position.	With engine running, place the machine/generator switch in the generator position.
Improper AC generator output voltage.	Hydraulic oil is cold and thick.	Use cold weather hydraulic oil as recommended. Warm oil before operating the machine.
Hydraulic fluid temperature 93°C (200°F) or more.	Prolonged boom operation or driving.	Stop operation until fluid cools.
	High pressure fluid return to reservoir caused by kinked or twisted hose.	Remove the kink or twist from the hose. Let fluid cool before resuming operation.
	Hydraulic system component failure.	Stow the machine and do not operate until repairs are made.
Severe hydraulic leak.	Failure of hose, tube, fitting, seal, etc.	Do not operate machine until repairs are made.

Appendix A – Glossary

aerial platform – a mobile device that has an adjustable position platform, supported from ground level by a structure.

ambient temperature – the air temperature of the immediate environment.

ammeter – an instrument for measuring the strength of an electric current in amperes.

authorized personnel – personnel approved as assigned to perform specific duties at a specific location.

base – the relevant contact points of the aerial platform that form the stability support (e.g. wheels, casters, outriggers, stabilizers).

boom – a movable cantilever beam which supports the platform.

center of gravity – the point in the aerial platform around which its weight is evenly balanced.

chassis – the integral part of the aerial platform that provides mobility and support for the booms.

fall restraint – a system that is used while working on a boom lift within the boundaries of platform guardrails to provide restraint from being projected upward from the platform. This system includes a harness or belt, lanyard, and a lanyard anchor. Federal OSHA, ANSI, and Snorkel require the use of additional fall protection beyond the platform guardrails on boom supported aerial platforms.

floor or ground pressure – the maximum pressure, expressed in pounds per square inch, a single wheel concentrates on the floor or ground.

gradeability – the maximum slope that the aerial platform is capable of travel.

guardrail system – a vertical barrier around the platform to prevent personnel from falling.

hazardous location – any location that contains, or has the potential to contain, an explosive or flammable atmosphere as defined by ANSI/NFPA 505.

intermediate boom – a telescopic boom section that extends and retracts from within the main boom. The intermediate boom is between the base, or lower most section of the main boom, and the tip boom.

jib – an articulating boom attached to the tip boom which increases the overall boom reach.

level sensor – a device that detects a preset degree of variation from perfect level. The level sensor is used to sound an alarm if operating on a slope greater than the preset value.

lower controls – the controls located at ground level for operating some or all of the functions of the aerial platform.

main boom – a boom assembly located between the turntable and the platform.

manufacturer – a person or entity who makes, builds or produces an aerial platform.

maximum travel height – the maximum platform height or the most adverse configuration(s) with respect to stability in which travel is permitted by the manufacturer.

maximum wheel load – the load or weight that can be transmitted through a single wheel to the floor or ground.

Minimum Safe Approach Distance – the minimum safe distance that electrical conductors may be approached when using the aerial platform. Also called M.S.A.D.

operation – the performance of any aerial platform functions within the scope of its specifications and in accordance with the manufacturer's instructions, the users work rules, and all applicable governmental regulations.

operator – a qualified person who controls the movement of an aerial platform.

personal fall arrest system – a fall protection system that is used while working on an unprotected edge (such as a roof top with no guardrail). This system includes a harness, lanyard or other connecting device, a fall arrestor, an energy absorber or decelerator, an anchorage connector, and a secure anchorage such as a building beam, girders or columns. An aerial platform is not a fall arrest anchorage.

platform – the portion of an aerial platform intended to be occupied by personnel with their tools and materials.

platform height – the vertical distance measured from the floor of the platform to the surface upon which the chassis is being supported.

prestart inspection – a required safety inspection routine that is performed daily before operating the aerial platform.

qualified person – a person, who by reason of knowledge, experience, or training is familiar with the operation to be performed and the hazards involved.

rated work load – the designed carrying capacity of the aerial platform as specified by the manufacturer.

stow – to place a component, such as the platform, in its rest position.

tip boom – a telescopic boom section that extends and retracts from within the main boom. The tip boom is nearest the platform.

turning radius – the radius of the circle created by the wheel during a 360° turn with the steering wheels turned to maximum. Inside turning radius is the wheel closest to the center and outside turning radius is the wheel farthest from the center.

turntable – the structure above the rotation bearing which supports the main boom. The turntable rotates about the centerline of rotation.

unrestricted rated work load – the maximum designed carrying capacity of the aerial platform allowed by the manufacturer in all operating configurations.

upper controls – the controls located on or beside the platform used for operating some or all of the functions of the aerial platform.

wheelbase – the distance from the center of the rear wheel to the center of the front wheel.

working envelope – the area defined by the horizontal and vertical limits of boom travel that the platform may be positioned in.

working height – platform height plus six feet.

LIMITED WARRANTY

Snorkel warrants each new machine manufactured and sold by it to be free from defects in material and workmanship for a period of one (1) year from date of delivery to a Customer or for one year after the machine has been placed in first service in a Dealer rental fleet, whichever comes first. Any part or parts which, upon examination by the Snorkel Service Department, are found to be defective, will be replaced or repaired, at the sole discretion of Snorkel, through its local Authorized Dealer at no charge.

Snorkel further warrants the structural components; specifically, the mainframe chassis, turntable, booms and scissor arms, of each new machine manufactured by it to be free from defects in material and workmanship for an additional period of four (4) years. Any such part or parts which, upon examination by the Snorkel Service Department, are found to be defective will be replaced or repaired by Snorkel through its local Authorized Dealer at no charge; however, any labor charges incurred as a result of such replacement or repair will be the responsibility of the Customer or Dealer.

The Snorkel Service Department must be notified within forty-eight (48) hours of any possible warranty situation during the applicable warranty period. Personnel performing warranty repair or replacement must obtain specific approval by Snorkel Service Department prior to performing any warranty repair or replacement.

Customer and Dealer shall not be entitled to the benefits of this warranty and Snorkel shall have no obligations hereunder unless the "Pre-Delivery and Inspection Report" has been properly completed and returned to the Snorkel Service Department within ten (10) days after delivery of the Snorkel product to Customer or Dealer's rental fleet. Snorkel must be notified, in writing, within ten (10) days, of any machine sold to a Customer from a Dealer's rental fleet during the warranty period.

At the direction of the Snorkel Service Department, any component part(s) of Snorkel products to be replaced or repaired under this warranty program must be returned freight prepaid to the Snorkel Service Department for inspection. All warranty replacement parts will be shipped freight prepaid (standard ground) from the Snorkel Service Department or from Snorkel's Vendor to Dealer or Customer.

REPLACEMENT PARTS WARRANTY

Any replacement or service part made or sold by Snorkel is not subject to the preceding Limited Warranty beyond the normal warranty period of the machine upon which the part was installed.

THIS WARRANTY EXCLUDES AND SNORKEL DOES NOT WARRANT:

1. Engines, motors, tires and batteries which are manufactured by suppliers to Snorkel, who furnish their own warranty. Snorkel will, however, to the extent permitted, pass through any such warranty protection to the Customer or Dealer.
2. Any Snorkel product which has been modified or altered outside Snorkel's factory without Snorkel's written approval, if such modification or alteration, in the sole judgment of Snorkel's Engineering and/or Service Departments, adversely affects the stability, reliability or service life of the Snorkel product or any component thereof.
3. Any Snorkel product which has been subject to misuse, improper maintenance or accident. "Misuse" includes but is not limited to operation beyond the factory-rated load capacity and speeds. "Improper maintenance" includes but is not limited to failure to follow the recommendations contained in the Snorkel Operation, Maintenance, Repair Parts Manuals. Snorkel is not responsible for normal maintenance, service adjustments and replacements, including but not limited to hydraulic fluid, filters and lubrication.
4. Normal wear of any Snorkel component part(s). Normal wear of component parts may vary with the type application or type of environment in which the machine may be used; such as, but not limited to sandblasting applications.
5. Any Snorkel product that has come in direct contact with any chemical or abrasive material.
6. Incidental or consequential expenses, losses, or damages related to any part or equipment failure, including but not limited to freight cost to transport the machine to a repair facility, downtime of the machine, lost time for workers, lost orders, lost rental revenue, lost profits or increased cost.

This warranty is expressly in lieu of all other warranties, representations or liabilities of Snorkel, either expressed or implied, unless otherwise amended in writing by Snorkel's President, Vice President-Engineering, Vice President-Sales or Vice President-Marketing.

SNORKEL MAKES NO WARRANTIES WHICH EXTEND BEYOND THE DESCRIPTION OF THIS LIMITED WARRANTY. SNORKEL MAKES NO IMPLIED WARRANTY OF MERCHANTABILITY OR FITNESS FOR A PARTICULAR PURPOSE AND DISCLAIMS ALL LIABILITY FOR INCIDENTAL OR CONSEQUENTIAL DAMAGES, INCLUDING BUT NOT LIMITED TO INJURY TO PERSONS OR PROPERTY.

The Customer shall make all warranty claims through its local Authorized Dealer and should contact the Dealer from whom the Snorkel product was purchased for warranty service. Or, if unable to contact the Dealer, contact the Snorkel Service Department for further assistance.

Effective July 1995

