

WALLBOARD CRANES

30000 WB SERIES 50000 WB SERIES

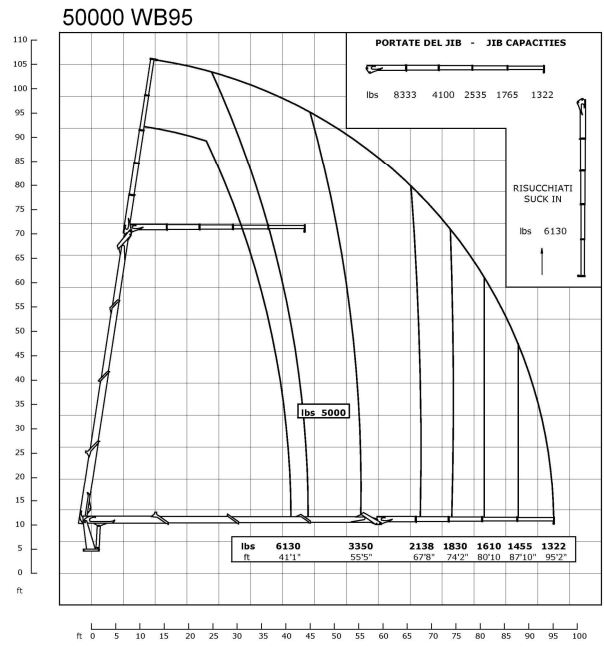

GORMACH

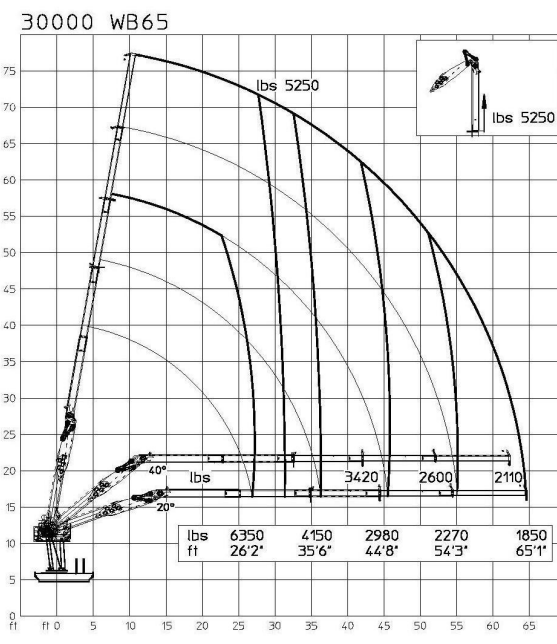
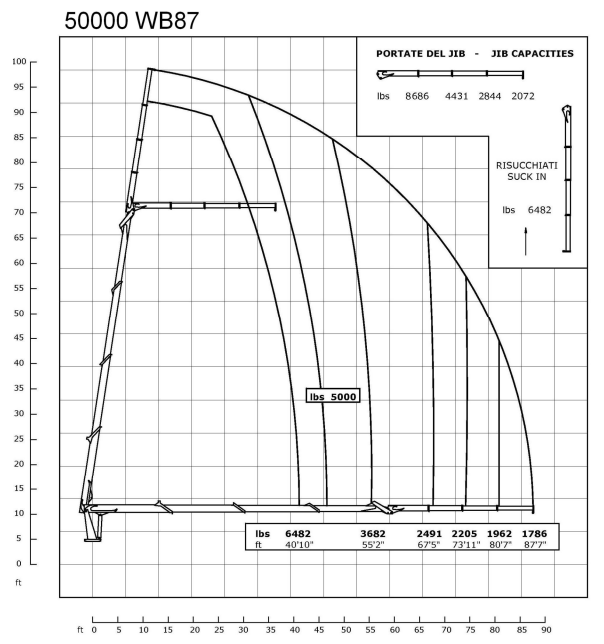
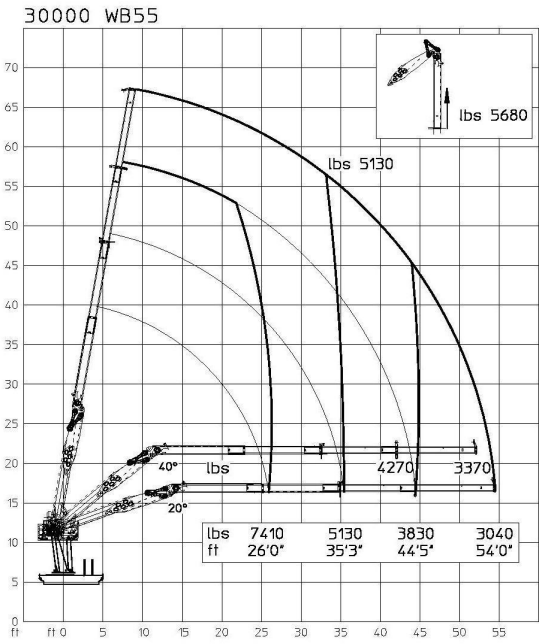
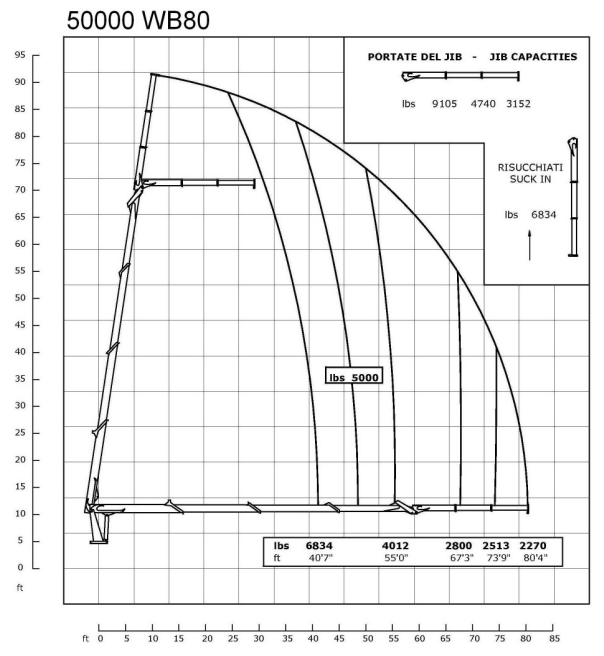
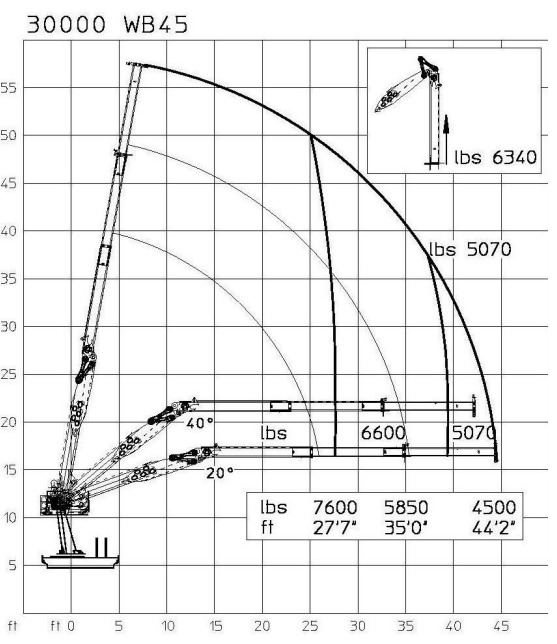

NORTH AMERICAN IMPORTER OF
CORMACH CRANES
(941) 729-9200
www.ccsi-cranes.com

The year was 1988 when Cormach first pioneered drywall deliveries into high-rises with the introduction of the 30000 WB series, capable of reaching heights over 85 feet. Seven years later a smaller wallboard boom was manufactured and put into production for which to compete in the residential and smaller commercial job market. After six years this crane was redesigned and an updated boom evolved. With three years in the field a new redesigned work horse evolved into the present 30000 WB series booms on the market today. For over twenty years Cormach has evolved their wallboard product line into a faster, smoother operating, more efficient and service friendly boom. These modifications have made Cormach the North American front runner in drywall and building material delivery booms.

Cormach has now taken the high-lift wallboard boom to the next level with the 50000 WB series. We are proud to offer the next generation of high lift wallboard booms. Using the technical knowledge of both the drywall industry of North America and other European markets, Cormach has developed the tallest, strongest and shortest stowed boom on the market today.

Only Cormach uses the rotation bearing and turret system on their complete product line that other manufacturers only use on their larger knuckle booms. The twin column turret design dissipates the lifting stresses and shock loads evenly into the 42" diameter ring gear and bearing surface. This eliminates unavoidable points of concentrated stresses at the upper bushings associated with other crane manufacturers designs.

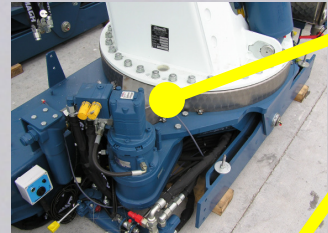

Cormach cranes have continuous rotation as a standard. This is not possible with a rack and pinion rotation system offered by other crane manufacturers.



The simplistic design of the column aids in safety and maintenance inspections as all stressed parts are visible and wear is measurable. All components can be extracted with minimum dismantling of other components. Six bolts drop the rotation gear box, spur gear and motor—no other parts need to be touched. One ring of bolts—all accessible—parts the entire turret and boom structure from the rotation bearing.

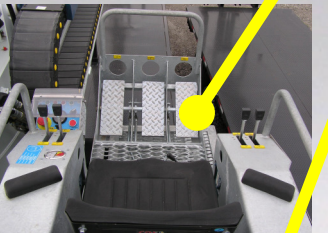

The control station offers extreme comfort by positioning the operator into a recumbent position. The complete information system and controls are within easy access of the operator.

Radio Remote Control Ready, fully proportional Danfoss valves give the Cormach crane the smooth fluid like motion when operated.

Increased productivity—

- The extension cylinders incorporate a regenerative system which increases the speed by almost 50% and reduces heat generated in the hydraulic system. This is accomplished by the oil being taken from the rod end of the cylinder and returning it to the base end of the cylinder without going through the pump and entire hydraulic system.

- Cormach wallboard cranes hydraulic system operate at 4120 psi on the 30000 WB series and 4650 psi on the 50000 WB series, use a stainless steel 66 gallon oil reservoir along with a variable displacement, load sensing pump that supplies hydraulic fluid on demand (26 gpm maximum). This too reduces the amount of heat that is generated in the hydraulic system. It further allows the crane to operate faster as any or all functions can be operated simultaneously.

An electro-hydraulic type load limiting device controls the lifted load of the crane. It only cuts off the movements that increase the moment in the different positions. A red light and audible buzzer inform the operator when the crane is in overload.

Technical Data:

Model	30000 WB	50000 WB
Series	45 – 55 – 65	80 – 87 – 95
Lifting Moment	258,000 – 279,000 ft/lbs	464,600 ft/lbs
Horizontal Reach	45'3" – 54'11" – 65'10"	80'4" – 87'7" – 95'2"
Vertical Reach	56' – 67' – 77'	92' – 98' – 106'
Rotation	Continuous	Continuous
Outrigger Span	25'	25' and 19' auxiliary
Crane Frame Space	41"	41"
Crane Weight in lbs	9,920 – 10,580 – 11,160	13,450 – 13,800 – 14,130

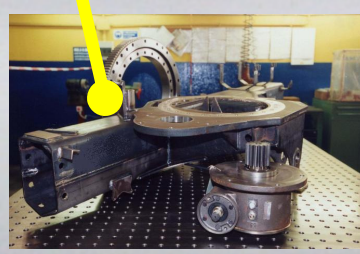

24'6" Bed space when installed on proper chassis

All Cormach WB series are under 40' OAL when installed on the proper chassis

See Cormach Technical Specifications for additional information

Specifications subject to change without prior notice due to continued development

CORMACH 50000 WB Series Booms With three inner boom sections and either two, three or four outer boom sections (depending on model) the boom is able to reach higher than any other boom on the market with greater capacities. The inner boom can reach to over 72' before the extending the outer boom. This higher range will allow you to reach places other manufacturers' booms can't, permitting you to accomplish higher and more accurate picks. The inner boom can be activated on a zero degree horizontal plane allowing a trailer to feed the boom drywall constantly throughout the job if necessary.

Even with the greater heights and longer extensions even the 95' boom will collapse for transportation to allow for a 24'6" bed keeping the overall length under 40' when installed on an acceptable chassis. The stowage under the boom for the load is over 78" under the inner boom and even at it's lowest point under the knuckle for the outer boom there is almost 75". Nothing on the bed impedes the loading of materials and the full use of the bed can be utilized.