

# Turmdrehkran 100 LC

Tower Crane / Grue à tour / Gru a torre  
Grúa torre / Guindaste de torre

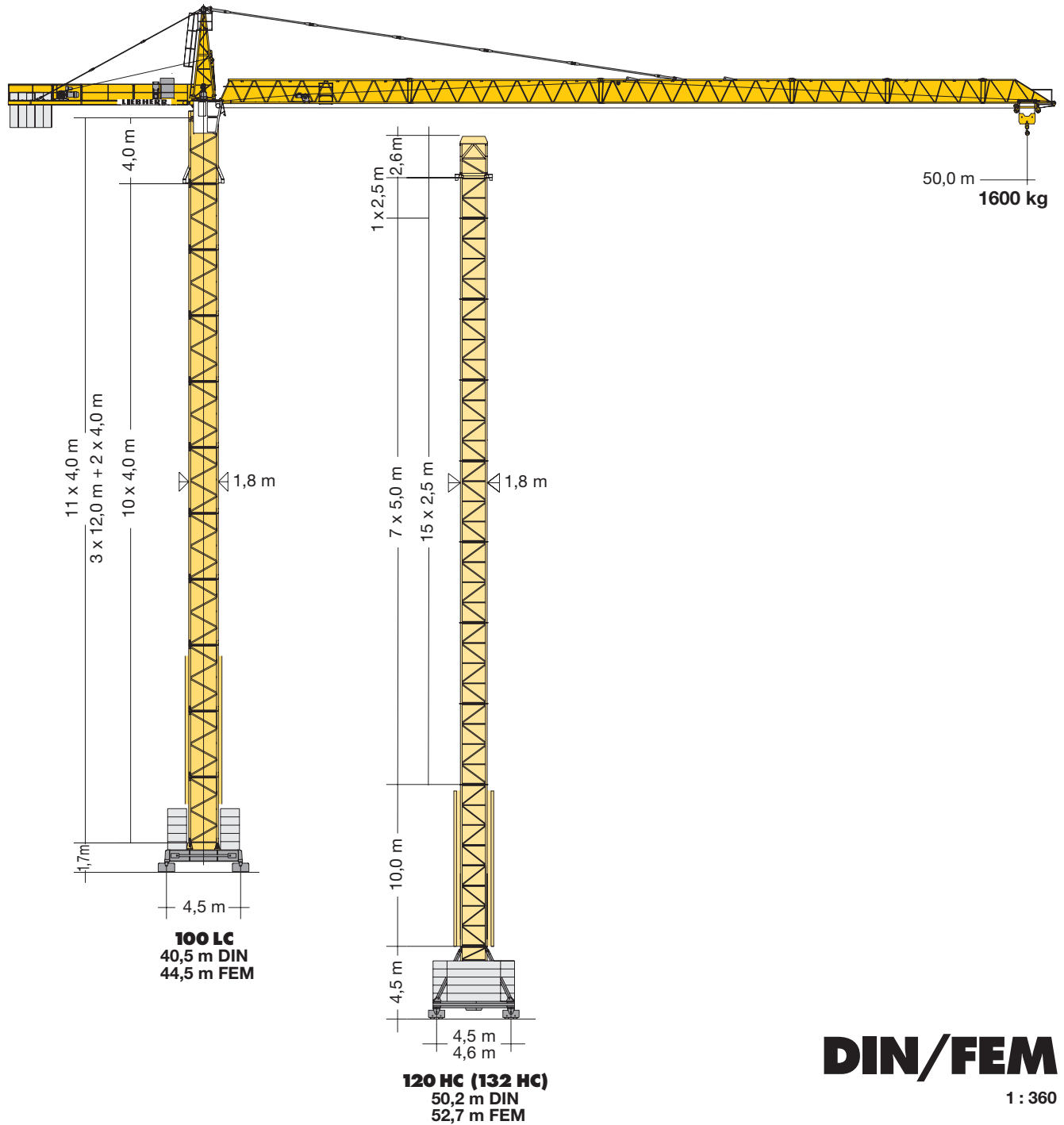

**DIN/FEM**

1 : 360

# LIEBHERR

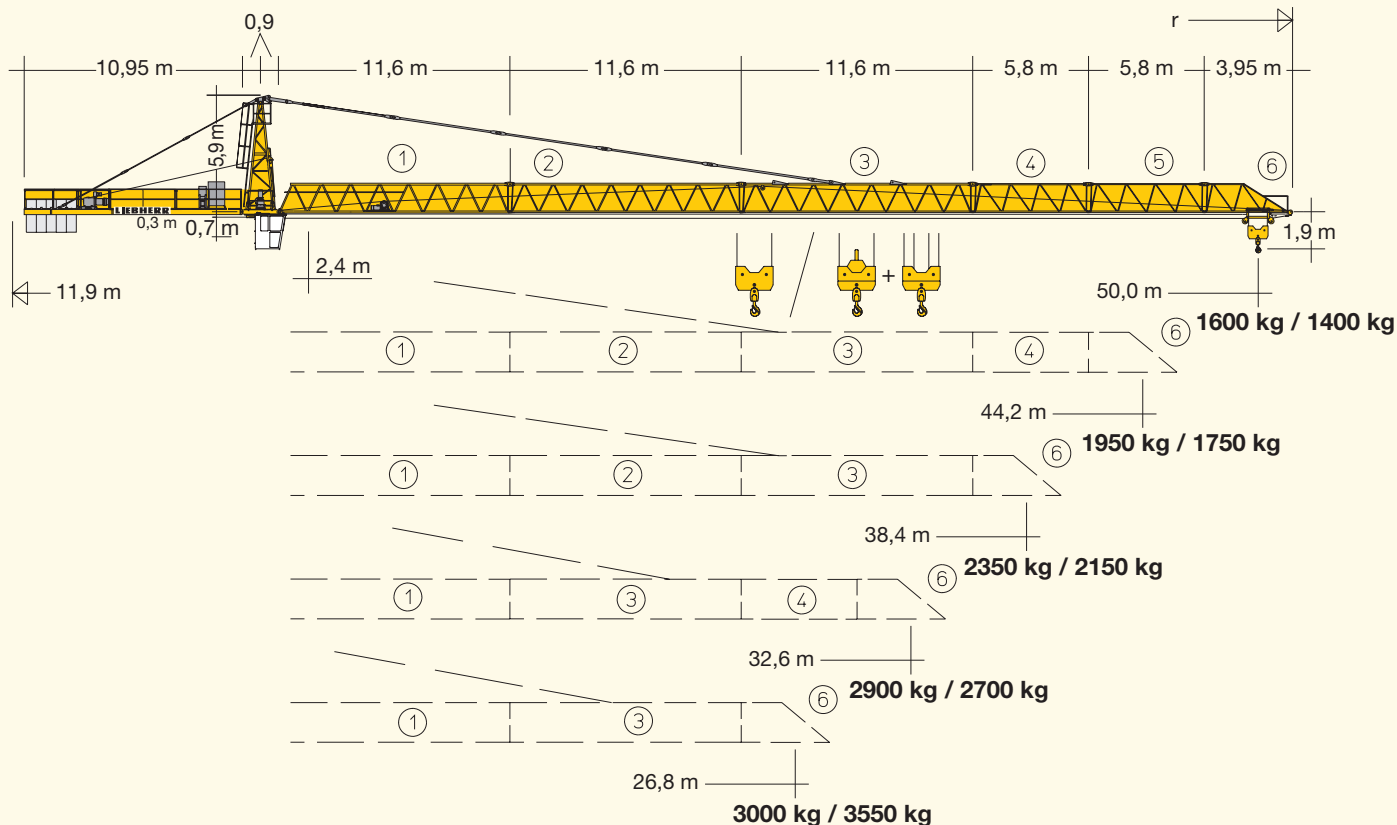

## Gewicht

Weight / Poids / Peso / Peso / Pesos

<b>Zentralballast</b> / Central ballast Lest de base / Zavorra centrale Lastro central / Lastre central	65000 kg		(Ausl. 50 m)	12750 kg		36900 kg
---	----------	--	--------------	----------	--	----------

## Hubhöhe

Hoisting height / Hauteur sous crochet / Altezza di sollevamento / Altura bajo gancho / Altura de montagem

		100 LC				
4 m	12 m					
11		44,5*	44,4*	44,1*	43,1*	55,2*
FEM 10		40,5*	40,4*	40,1*	39,1*	51,2*
9	3	36,5	36,4	36,1	35,1	47,2
DIN 8		32,5	32,4	32,1	31,1	43,2
7		28,5	28,4	28,1	27,1	39,2
6	2	24,5	24,4	24,1	23,1	35,2
5		20,5	20,4	20,1	19,1	31,2
4		16,5	16,4	16,1	15,1	27,2
3	1	12,5	12,4	12,1	11,1	23,2
2		8,5	8,4	8,1	7,1	19,2
1		4,5	4,4	4,1	3,1	15,2
0						11,2
		m	m	m	m	m

\* **Weitere Hubhöhen auf Anfrage.** / Further hoist heights on request. / Hauteurs sous crochet sur demande. / Altre altezze di sollevamento: su richiesta. / Outras alturas de elevação: conforme ao pedido. / Para alturas bajo gancho superiores, consultar.  
 \*\* **nicht kletterbar** / not for climbing / non télescopable / non telescopabile / no trepable / no telescopable

# Ausladung und Tragfähigkeit

Radius and capacity / Portée et charge / Sbraccio e portata / Alcances y cargas / Alcance e capacidade de carga

m	r	m/kg	m/kg													
			16,0	18,0	20,0	22,0	24,0	26,8	30,0	32,6	36,0	38,4	42,0	44,2	48,0	50,0
50,0	(r=51,6)	2,4-29,3 3000						3000	2920	2660	2370	2200	1970	1860	1680	1600
44,2	(r=45,8)	2,4-30,5 3000						3000	3000	2780	2480	2300	2070	1950		
38,4	(r=40,0)	2,4-31,1 3000						3000	3000	2840	2530	2350				
32,6	(r=34,2)	2,4-31,6 3000						3000	3000	2900						
26,8	(r=28,4)	2,4-26,8 3000						3000								

m	r	m/kg	m/kg		m/kg												
			16,0	18,0	20,0	22,0	24,0	26,8	30,0	32,6	36,0	38,4	42,0	44,2	48,0	50,0	
50,0	(r=51,6)	2,4-27,6 3000	2,4-15,3 6000	5700	4970	4400	3930	3550	3110	2710	2450	2160	1990	1770	1660	1480	1400
44,2	(r=45,8)	2,4-28,8 3000	2,4-15,9 6000	5970	5210	4610	4130	3730	3270	2850	2580	2280	2100	1870	1750		
38,4	(r=40,0)	2,4-29,3 3000	2,4-16,2 6000	6000	5320	4710	4220	3810	3340	2920	2640	2330	2150				
32,6	(r=34,2)	2,4-29,9 3000	2,4-16,5 6000	6000	5440	4820	4310	3890	3420	2990	2700						
26,8	(r=28,4)	2,4-26,8 3000	2,4-17,0 6000	6000	5640	4990	4470	4040	3550								



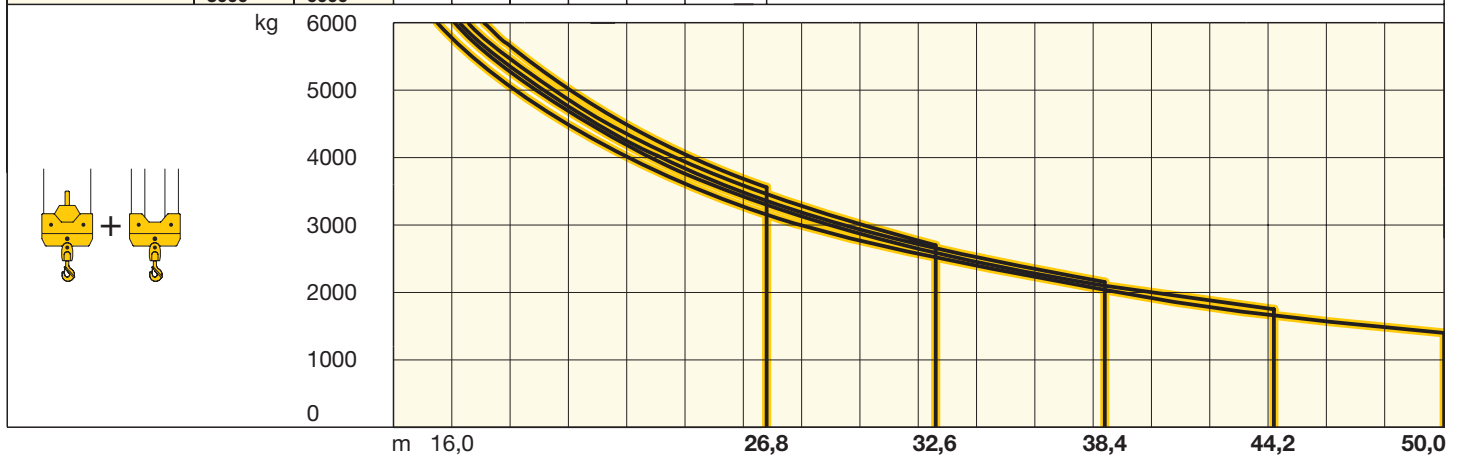



## Hubhöhe



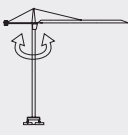

Hoisting height / Hauteur sous crochet / Altezza di sollevamento / Altura bajo gancho / Altura de montagem

		120 HC (132 HC)				
FEM	15	52,7*	52,2*	48,4*	49,9*	49,7*
DIN	14	50,2*	49,7*	45,9*	47,4*	47,2*
	13	47,7	47,2	43,4	44,9	44,7
	12	45,2	44,7	40,9	42,4	42,2
	11	42,7	42,2	38,4	39,9	39,7
	10	40,2	39,7	35,9	37,4	37,2
	9	37,7	37,2	33,4	34,9	34,7
	8	35,2	34,7	30,9	32,4	32,2
	7	32,7	32,2	28,4	29,9	29,7
	6	30,2	29,7	25,9	27,4	27,2
	5	27,7	27,2	23,4	24,9	24,7
	4	25,2	24,7	20,9	22,4	22,2
	3	22,7	22,2	18,4	19,9	19,7
	2	20,2	19,7	15,9	17,4	17,2
	1	17,7	17,2	13,4	14,9	14,7
	0	15,2	14,7	10,9	12,4	12,2

Diagram	Dimensions (m)
	3,1 m jib, 10,0 m height, 4,5 m base, 4,6 m track
	3,1 m jib, 10,0 m height, 4,0 m base, 4,6 m track
	2,5 m jib, 10,0 m height, 0,22 m base, 4,6 m track
	1) 2,5 m jib, 2) 3,1 m height, 1,7 m base, 1) 3,8 m track, 2) 4,6 m track
	1) 2,7 m jib, 2) 3,1 m height, 1,5 m base, 1) 3,8 m track, 2) 4,6 m track

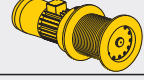
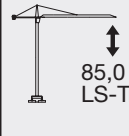













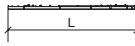

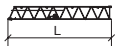

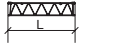

	U/min 0 – 0,8 sl./min tr./min	1 x 7,5 kW FR.tronic-FU
	9,0 / 30,0 / 60,0 m/min	0,65 / 2,0 / 3,0 kW
	18,0 m/min 25,0 m/min	2 x 2,6 kW (100 LC) 2 x 4,0 kW (120 HC)
	<b>kVA</b>	22,0 kW 22,0 kW FU 39,0 30,0

	<b>Stufe / Step</b> Cran / Marcia Marcha / Marcha	kg	m/min
	3,8 / 18,5 / 22,0 kW WIW 230 MZ 402 <b>3 Lagen</b> Layers Couches Strati Camadas Capas	1 3000 2 3000 3 1800	3000 6,0 3000 27,0 1700 56,0
	85,0 m LS-Trommel <b>5 Lagen</b> Layers Couches Strati Camadas Capas	1 2 3	6000 3,0 6000 13,5 3700 28,0
	149,0 m LS-Trommel <b>5 Lagen</b> Layers Couches Strati Camadas Capas	1 3000 2 3000 3 1700	3000 6,2 3000 28,0 1600 58,0
	22,0 kW FU WIW 230 MZ 404 <b>5 Lagen</b> Layers Couches Strati Camadas Capas	1 3000 2 3000 3 2400 4 1500	3000 3,1 3000 31,0 2250 43,0 1350 70,0
	149,0 m LS-Trommel	1 2 3 4	6000 1,5 6000 15,0 4800 22,0 3000 35,0

## Kolli-Liste

Packing List / Liste de colisage / Lista dei colli / Lista de contenido / Lista de embalagem

Montagegewichte: siehe Betriebsanleitung. / Erection weights: see instruction manual. / Poids de montage: voir manuel de service.  
Pesi di montaggio: vedasi le istruzioni sull'uso. / Pesos de montagem: vejã-se es instruções p. uso. / Peso para el montaje: según manual.

<b>Kranoberteil</b>		Upper part of crane / Partie supérieure de grue / Parte superiore della gru Parte superior grúa / Parte superior do guindaste	L (m)	B (m)	H (m)	kg*		
Pos. Item Rep. Voce Pos. Ref.	Anz. Qty. Qte. Cant. Cant.	<b>Kabine + Steuerstand / Cabin + Seat</b> Cabine + fauteuil / Cabina + poltrona Cabine + cadeira / Cabina + butaca			1,87	1,12	2,18	440
2	1	<b>Turmspitze / Tower head section</b> Porte-flèche / Testa porta-braccio Cabeça de apoio de lança / Cabeza de torre			5,62	1,16	1,57	740
3	1	<b>Gegenausleger / Counter-jib</b> Contre-flèche / Contrabaccio Contra-lança / Contrapluma			11,03	1,67	0,45	1480
4	1	<b>Ausleger-Anlenkstück / Jib heel section</b> Pied de flèche / Settore articolato di braccio Base articulada de lança / Pluma tramo primero			11,79	1,17	1,59	① 1520
5	1	<b>Ausleger-Zwischenstück / Intermediate jib section</b> Elément interm. de flèche / Spezzone di braccio Peça suplementar da lança / Tramo intermedio pluma			11,68 11,83 6,02 6,00	1,17 1,17 1,17 1,17	1,54 1,63 1,53 1,51	② 1060 ③ 1000 ④ 360 ⑤ 267
6	1	<b>Ausleger-Kopfstück / Jib head</b> Pointe de flèche / Punta freccia Cabeça de lança / Tramo punta de pluma			4,16	1,17	1,72	⑥ 230
7	1	<b>Podeste / Platforms</b> Plates-formes / Plattaforma Plataforma / Plataforma			1,68	0,33	1,82	166
8	1	<b>Laufkatze / Trolley</b> Chariot / Carrello Carrinho / Carrito			1,57	1,34	0,77	170
9	1	<b>Drehbühne mit Kud-Auflage / Slewing platform with slewing ring support</b> Ensembles mât cabine avec pivot cage / Plattaforma girevole con supporto della ralla di rotazione / Plataforma giratória con suporte de coróã dentada / Asiento pista con plataforma giratoria			1,60	2,01	1,93	2590
10	1	<b>Hubwerk / Winch</b> Treuil / Verricello / Mecanismo elevatorio Mecanismo elevación carga			1,50	1,36	0,71	655

Pos. Anz.  
Item Qty.  
Rep. Qte.  
Voce Qta.  
Pos. Cant.  
Ref. Cant.

			L (m)	B (m)	H (m)	kg*	
<b>Turm</b> Tower / Mât / Torre Torre / Torre							
11	1	<b>Turmstück</b> / Tower section Element de mât / Elemento di torre Torre / Torre		12 m 4 m	12,27 1,80	1,80 1,90	2870 1105
12	1	<b>Grundturmstück</b> / Base tower section Mât de base / Elemento di torre base Tramo torre base / Peça de base de torre		12,00	2,02	2,02	3812
<b>Klettereinrichtung</b> Climbing equipment / Equipement de télescopage / Attrezzatura per allungamento della gru Equipo de trepado / Acessórios p. subida no edificio							
13	1	<b>Führungsstück kpl.</b> / Guide section cpl. Cage télescopique cpl. / Gabbia di sopraelevazione compl. Peça de guia compl. / Torre de montagem completa		8,92	2,25	2,35	2180
14	1	<b>KUD-Auflagenverlängerung</b> / Slewing ring support extension Rehausse de pivot d'orientation / Prolunga supporto ralla Peça de guia / Prolongación asiento de pista		4,27	2,26	2,26	1370
15	1	<b>Hydraulikanlage, Stütz- und Klettertraverse</b> / Hydraulic unit, supporting and climbing cross members Système hydraulique avec traverses d'appui et de télescopage / Sistema idraulico, traversa di appoggio e allugamento gru Instalação hidráulica, travessa de apoio e subida / Sistema hidráulico con travesía de apoyo y trepado					
<b>Fundamentkreuz</b> Cruciform base / Châssis en croix / Carro della gru Carro de guindaste / Base cruciforme							
16	1	<b>Tragholm I</b> / Arm I Longeron I / Longherone I Travessa I / Brazo I		6,66	0,71	0,75	2110
17	2	<b>Tragholm II</b> / Arm II Longeron II / Longherone II Travessa II / Brazo II		6,66	0,78	0,75	2330
18	2	<b>Fahrschemel mit Antrieb</b> / Rail bogie with drive Bogie moteur / Telaio con gruppo propulsore Quadro sem grupo de propulsão / Caja rodillo motriz		1,07	0,52	0,65	460
19	2	<b>Fahrschemel ohne Antrieb</b> / Rail bogie without drive Bogie fou / Telaio senza gruppo propulsore Quadro com grupo de propulsão / Caja rodillo conducido		1,07	0,25	0,65	380
20	1	<b>Seile und Kleinteile</b> / Small parts and ropes Accessoire et câbles / Accessori cavi Acessorios e cabos / Accesorios y cables		-	-	-	4700

\* Einzelgewichte. / Single weights. / Poids individuels. / Pesì di componenti. / Pesos de peças componentes. / Pesos unitarios.

## Klettern im Gebäude

Climbing in the building / Télescopage dans le bâtiment / Pure  
varianti di gru allungabili / Subida no edificio / Trepado dentro del edificio

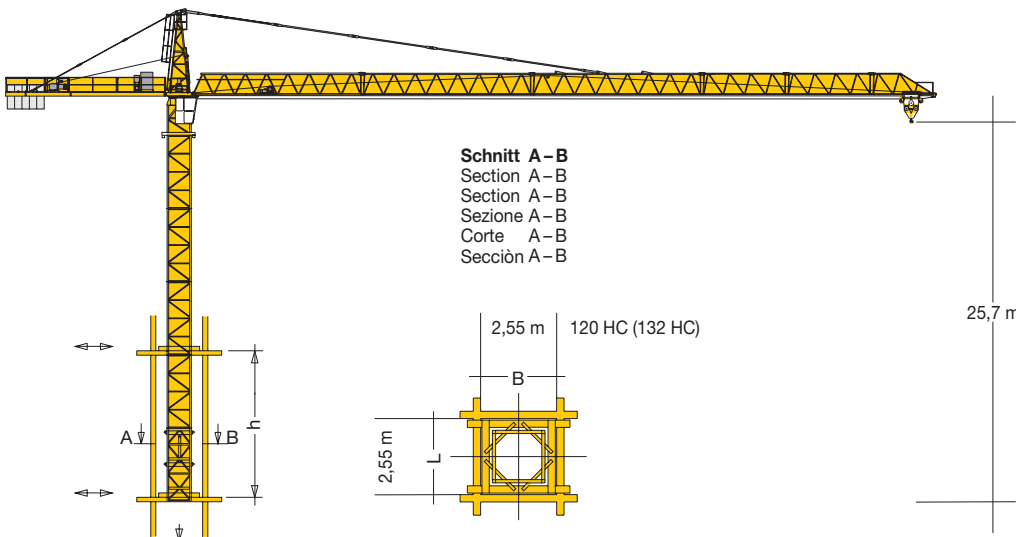

**Konstruktionsänderungen vorbehalten!**  
Subject to alterations! / Sous réserves de modifications!  
Si fa riserva di modifiche! / Salvo modificação da construação!  
¡Sujeto a modificaciones!

**Sämtliche Angaben erfolgen ohne Gewähr.** / This information is supplied without liability.  
Ces renseignements sont sans garantie. / Le indicazioni contenute si intendono salvo errori ed omissioni.  
Declinamos toda responsabilidad derivada de la información proporcionada. / Declinamos qualquer  
responsabilidade quanto à informação fornecida.

**121 P – 3319 H1 B3 DIN 15018 • BGL C.0.10.0100 / FEM (Section 1) – Krangruppe A3 • 05.05 / 6**

Printed in Germany.