

Manیتowoc 8000-1

Product Guide

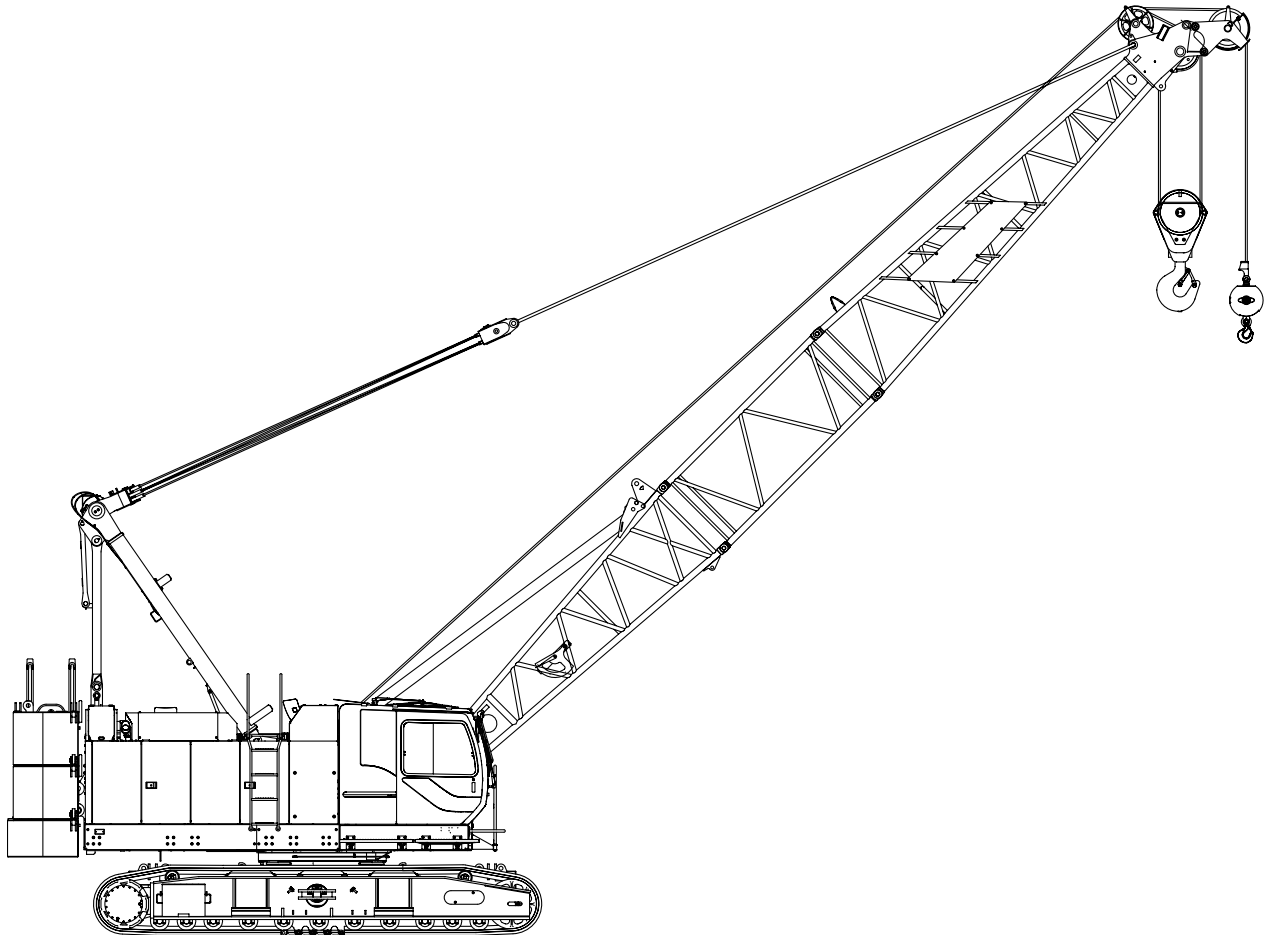

Features

- 80 USt capacity
- 200 ft heavy-lift boom
- Max boom + jib combination:
180 ft + 60 ft
- 285 HP engine
- 525 fpm maximum line speed
- 17,000 lb rated line pull

Contents

Specifications	4
Outline dimensions	7
Winch performance data	12
Load chart notes	13
Boom combinations	14
Heavy-lift boom range / charts	16
Fixed jib boom range / charts	18
Clamshell	21
Manitowoc Crane Care	22

Specifications

Upperworks



Engine

HINO J08E-UV, 6 cylinder, water-cooled diesel, direct fuel injection with turbocharger, 285 HP at 2100 high-idle RPM. Maximum torque 750 lb•ft net at 1,600 rpm; Interim Tier 4/Stage IIIB (Required for sale in the US/Canada/Europe; requires "Ultra Low Sulfur Diesel")

One diesel fuel tank, 105 gallons capacity.

Two 12 volt 136 AH capacity batteries, 24 volt system and 90 amp alternator.

All wiring harnesses and connectors are numbered for easier servicing. Machine is equipped with individual fused branch circuits.



Controls

Full-flow hydraulic control system for constant variable pressure to front and rear drums, boom hoist brakes and clutches. Controls respond instantly to the touch, delivering smooth function operation.

Relief valve pressures:

Load hoist, boom hoist and propel system	4,630 psi
Swing system	3,989 psi
Control system	783 psi



Hydraulic system

All three variable displacement piston-type pumps are driven by a heavy-duty pump drive. One of these pumps is used in the right propel circuit and boom hoist circuit, and can accommodate an optional third circuit. Another is used in the left propel circuit and hook hoist circuit. The third variable displacement pump is used in the swing circuit. In addition, two gear pumps are used in the control system and auxiliary equipment, and two gear pumps serve the brake cooling system.

Maximum pressure rating 4,630 psi

Load hoist, boom hoist and propel . . . 2 Piston pumps
Swing 1 Piston pump
Control system and auxiliary 2 Gear pumps
Brake cooling system 2 Gear pumps

Reservoir capacity 116 US gallon

Cooling: Oil-to-air heat exchanger (plate-fin type).

Filtration: Full-flow and bypass type with replaceable paper element.



Drums

Front and rear drums for load hoist powered by variable displacement piston-type motors, driven through planetary reducers. Powered hoisting/lowering and free-fall operation is standard. Drum turn indicators for front and rear drums are also standard.

Brakes: spring set, hydraulically-released, multiple-disk holding brake is mounted on the hoist motor and is operated through a counter-balance valve. An external ratchet is fitted for locking the drums.

Drums: (front and rear) 21.5" P.C.D. x 21.7" wide drums, grooved for 22.0 mm wire rope.

Wire rope capacity:

Front drum 869 ft working length
 Rear drum 673 ft working length

Line speed: Single line on the first drum layer

Hoisting: 390 ft/min

Lowering: 390 ft/min

➤ **Optional third drum:** free-fall is optional; drum grooved for 22 mm wire rope.

Wire rope working length 476 ft



Swing system

Swing unit: Powered by a hydraulic piston-type motor driving spur gears through planetary reducers, the swing system provides 360° rotation.

Swing brake: A spring-set, hydraulically released multiple-disc brake is mounted on swing motor.

Swing lock: 4-Position lock for transportation.

Rotating bed turntable: Single-row ball bearing with an integral internally cut swing gear.

Swing speed: 4.0 rpm



Boom support system

Single drum powered by a hydraulic axial piston motor through a planetary reducer.

Brake: A spring-set, hydraulically released multiple-disc brake is mounted on the boom hoist motor. An external ratchet is fitted for locking the drum.

Drum: Single drum, grooved for 16 mm diameter wire rope. Boom hoist reeving is 12-part line.

Specifications

Wire Rope Capacity:

Drum 492 ft working length.

Line speed:

Hoisting 230 ft/min

Lowering 230 ft/min



Gantry

This high folding type gantry is fitted with a sheave frame for boom hoist reeving. Hydraulic lift is standard. It provides full up, full down positions.



Counterweight

Upper weight (5 pieces): 57,584 lb

Carbody weight (2 pieces): 14,330 lb



Operator's cab

Totally enclosed, full vision cab fitted with tinted safety glass and opening front window. A fully adjustable, highbacked seat with arm rests. Short handle control levers; electronic twist grip hand throttle. An air conditioner, a signal horn and windshield wiper are standard.

Lights:

2 - Front flood lights

1 - Cab inside light

Safety device

New easy to read at a glance LMI and maintenance display.

Lowerworks



Carbody

The durable carbody features steel welded construction with extendible axles.



Crawlers

Crawler assemblies can be hydraulically extended for wide-track operation. Crawler belt tension adjusted with hydraulic jack and maintained by shims between idler block and frame.

The independent hydraulic propel drive is built into each crawler side frame. Each drive consists of a hydraulic motor driving a propel sprocket through a planetary gearbox. The hydraulic motor and gearbox

are built into the crawler side frame within the shoe width. The track rollers are sealed for maintenance-free operation.

Crawler shoes

36" wide crawler.

Travel speed

(High/Low) 1.07/0.71 mph

Attachments



Boom

Welded lattice construction using tubular, high-tensile steel chords with pin connections between sections. Two idler sheaves and four point sheaves are standard.

Basic boom length 50 ft consists of the boom butt section 19 ft, 10 ft boom insert and boom top section 21 ft.

Optional boom inserts are available to provide extension capabilities. They also have welded lattice construction with tubular, high-tension steel chords and pin connections on each one of the 10 ft, 20 ft, 40 ft inserts.

Maximum total length of boom 200 ft.



Fixed jib

The optional fixed jib employs welded lattice construction with tubular, high-tensile steel chords with pin connections between sections.

Basic jib length 30 ft consists of jib butt section 15 ft and jib top section 15 ft.

Optional jib boom inserts of 10 ft, 20 ft are available for extension capabilities up to 60 ft.

Maximum total length of boom and jib 180 ft + 60 ft is 240 ft.

Tools and accessories

A set of tools and accessories are furnished.

Optional equipment

➤ Optional: blocks and hooks each with roller bearing sheaves grooved for 22 mm diameter wire rope, and roller bearing swivel with hook latch.

➤ 12 USt ball hook, 722 lb wedge socket for 22 mm wire rope.

➤ 60 USt hook block, 2,486 lb, with four 24" Nominal O.D. roller bearing sheaves.

Specifications

- ▶ 90 USt hook block, 2,892 lb with five 24" Nominal O.D. roller bearing sheaves.
- ▶ Optional: Detachable upper boom point with one 561 mm Nominal O. D. roller bearing steel sheave grooved for 22 mm rope for liftcrane.

Working weight

Approximately 165,600 lb including upperworks and lowerworks, full upper counterweights, full carbody counterweights and 50 ft basic boom.

Ground pressure

Approximately 10.8 psi with basic boom.

Gradeability

With basic boom: 40%.

Outline dimensions

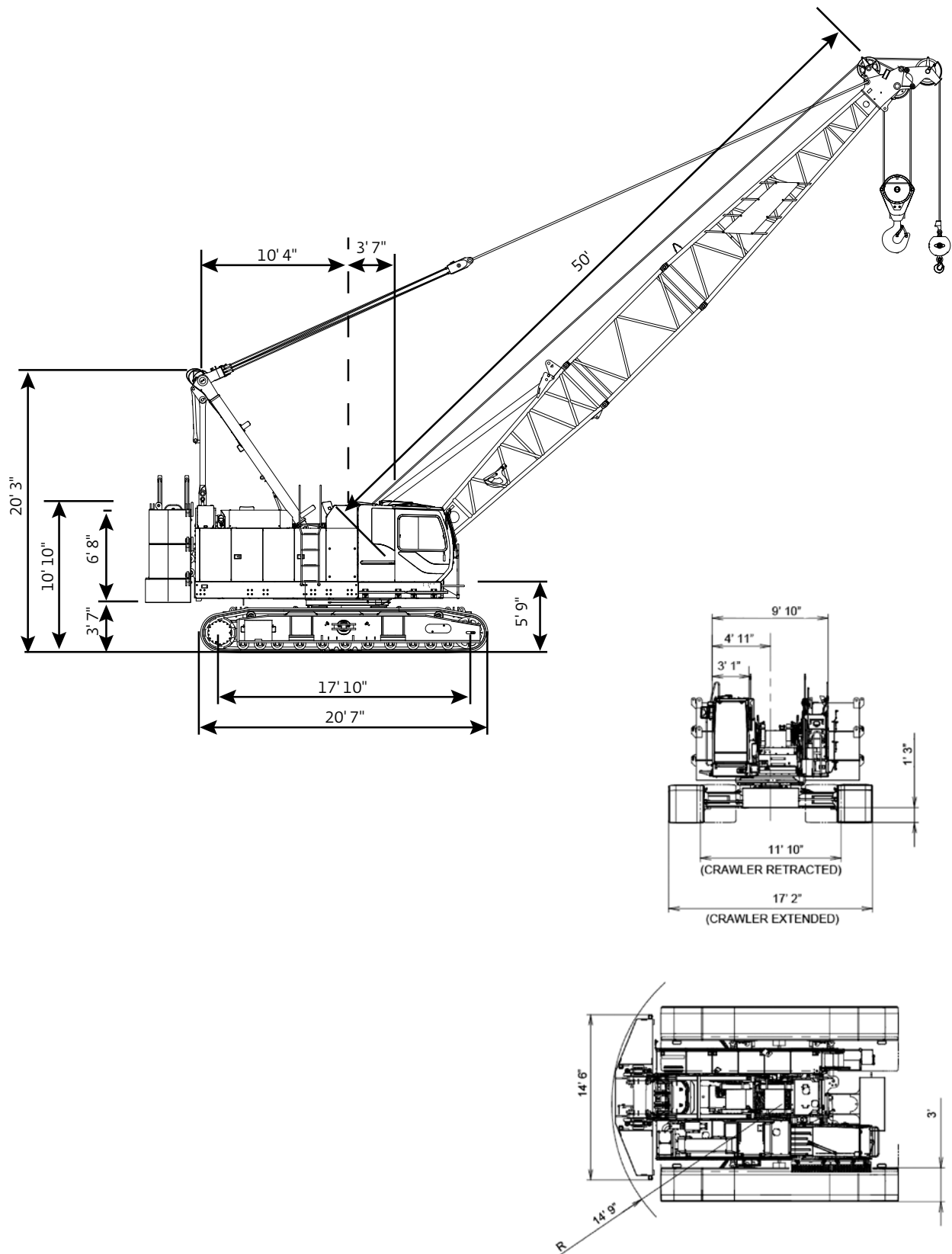

Outline dimensions

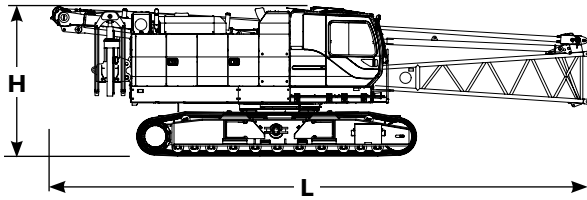

Upperworks	x 1
Length	39' 8"
Width	11' 10"
Height	10' 10"
Weight	91,677 lb

Note: Weight includes base machine, crawler, gantry, maximum hoist and whip lines on drums, boom butt, full hydraulic fluid reservoir, and one third tank of fuel.

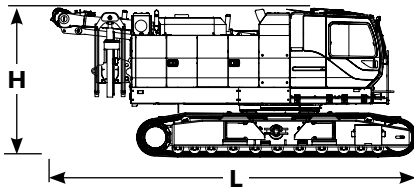

Upperworks	x 1
Length	27' 0"
Width	11' 10"
Height	10' 10"
Weight	87,434 lb

Note: Weight includes base machine, crawler, gantry, maximum hoist and whip lines on drums, full hydraulic fluid reservoir, and one third tank of fuel.

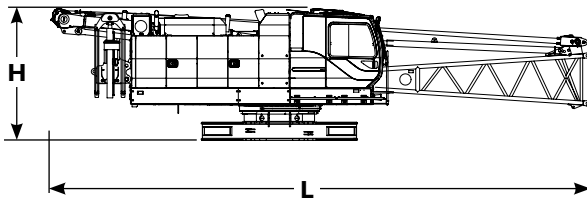

Upperworks without crawlers	x 1
Length	39' 8"
Width	9' 10"
Height	9' 7"
Weight	57,981 lb

Note: Weight includes base machine, gantry, maximum hoist and whip lines on drums, boom butt, full hydraulic fluid reservoir, and one third tank of fuel.

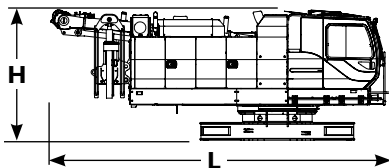

Upperworks without crawlers	x 1
Length	25' 3"
Width	9' 10"
Height	9' 8"
Weight	53,748 lb

Note: Weight includes base machine, gantry, maximum hoist and whip lines on drums, full hydraulic fluid reservoir, and one third tank of fuel.

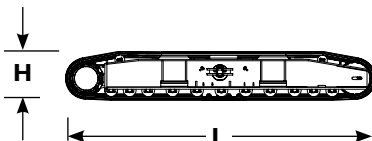

Crawlers	x 2
Length	20' 7"
Width	3' 0"
Height	3' 3"
Weight	16,843 lb

Option

Outline dimensions

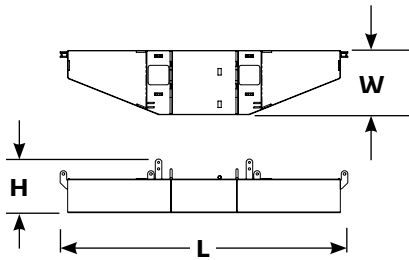

Upper counterweight	x 1
Length	14' 6"
Width	3' 3"
Height	2' 9"
Weight	20,550 lb

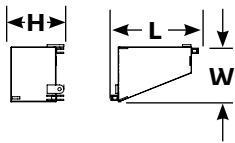

Upper counterweight (R)	x 2
Length	4' 9"
Width	3' 1"
Height	2' 11"
Weight	9,260 lb

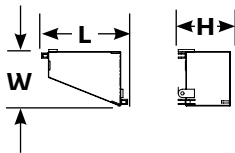

Upper counterweight (L)	x 2
Length	4' 9"
Width	3' 1"
Height	2' 11"
Weight	9,260 lb

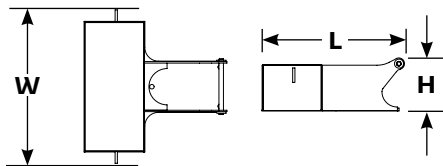

Carbody counterweight	x 2
Length	5' 2"
Width	5' 7"
Height	1' 11"
Weight	7,165 lb

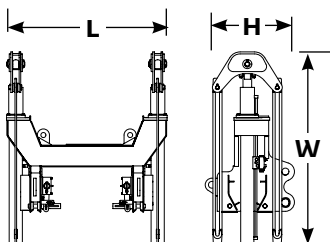

Self removal unit	x 1
Length	5' 3"
Width	6' 3"
Height	2' 11"
Weight	1,896 lb

Outline dimensions

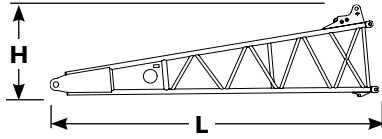

Boom butt 19'		x 1
Length	19' 7"	
Width	4' 8"	
Height	5' 7"	
Weight	2,326 lb	

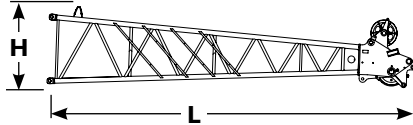

Boom top 21'		x 1
Length	22' 8"	
Width	4' 6"	
Height	4' 10"	
Weight	2,227 lb	

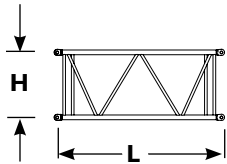

Boom insert 10'		x 1,2
Length	10' 4"	
Width	4' 6"	
Height	4' 4"	
Weight	590 lb	

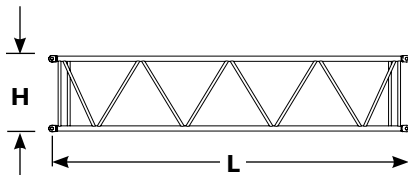

Boom insert 20'		x 1,2
Length	20' 5"	
Width	4' 6"	
Height	4' 4"	
Weight	1,025 lb	

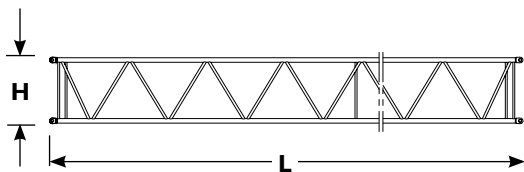

Boom insert 40'		x 1,2,3
Length	40' 5"	
Width	4' 6"	
Height	4' 4"	
Weight	1,896 lb	

Note: Use one "A" type insert with lug required for any boom combinations that require a 40' insert.

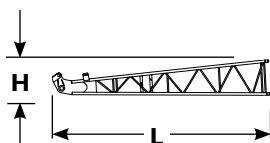

Fixed jib butt		x 1
Length	15' 9"	
Width	2' 8"	
Height	2' 8"	
Weight	440 lb	

Outline dimensions

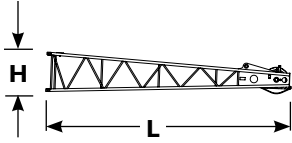

Fixed jib top		x 1
Length		16' 1"
Width		2' 7"
Height		2' 8"
Weight		485 lb

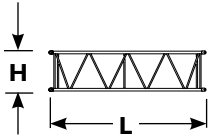

Fixed jib insert 10'		x 1
Length		10' 2"
Width		2' 8"
Height		2' 8"
Weight		210 lb

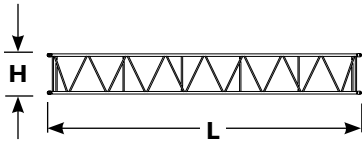

Fixed jib insert 20'		x 1
Length		20' 3"
Width		2' 8"
Height		2' 8"
Weight		390 lb

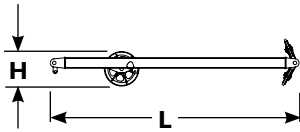

Fixed jib strut		x 1
Length		11' 11"
Width		2' 9"
Height		1' 8"
Weight		456 lb

Winch performance data

Line pull		
	Rated line pull lb	*Maximum line pull lb
Front drum	17,000	34,400
Rear drum	17,000	34,400
Optional 3rd drum	17,000	34,400

* Maximum line pull is not based on wire rope strength.

Wire rope specifications				
Use	Specs	Diameter mm	Working length ft	Breaking strength lb
Front drum	IWRCC/O 6 X Fi (29)	22,0	869	81,570
Rear drum	IWRCC/O 6 X Fi (29)	22,0	672	81,570
Boom hoist drum	IWRCC/O 6 X Fi (31)	22,0	492	47,210
Optional 3rd drum	IWRCC/O 6 X Fi (29)	22,0	476	81,570

Front and rear winch							
Layer		Line speed ft/min					
		1	2	3	4	5	6
Single line pull lb							
Rated line pull	0	394	420	446	495	499	525
	5,000	394	420	466	495	499	525
	10,000	353	353	353	353	353	353
	15,000	235	235	235	235	235	235
	17,000	208	208	208	208	208	208
	20,000	176	176	176	176	179	182
	25,000	141	146	148	149	149	–
	30,000	123	–	–	–	–	–

NOTE: Line speeds and line pull based on single line.
Line pulls are not based on wire rope strength.

Load chart notes

- Rated loads included in the charts are the maximum allowable freely suspended loads at a given boom length, boom angle and load radius, and have been determined for the machine standing level on firm supporting surface under ideal operating conditions. The user must limit or de-rate rated loads to allow for adverse conditions (such as soft or uneven ground, out-of-level conditions, wind side loads, pendulum action, jerking or sudden stopping of loads, inexperience of personnel, multiple machine lifts, and traveling with a load).
- Capacities do not exceed 75% of minimum tipping loads. Capacities based on factors other than machine stability such as structural competence are shown by asterisk * in the charts.
- The machine must be reeved and set-up as stated in the operation manual and all the instruction manuals. If these manuals are missing, obtain replacements. Boom backstops are required for all boom lengths. Gantry must be in the fully raised position for all operations. Crawlers must be fully extended and be locked in position. The crane must be leveled to within 1% on a firm supporting surface.
- Do not attempt to lift where no radius or load is listed as crane may tip or collapse.
- Attempting to lift more than rated loads may cause machine to tip or collapse. Do not tip machine to determine capacity.
- Weight of hooks, hook blocks, slings and other lifting devices are a part of the total load. Their total weight must be subtracted from the rated load to obtain the weight that can be lifted.
- When lifting over boom point with jib or upper boom point installed, rated loads for the boom must be deducted as shown below.

jib length ft	Upper boom point	30	40	50	60
Deduct lb	320	2,400	3,200	4,200	5,200

- The total load that can be lifted by the jib is limited by rated jib loads.
- Boom lengths for jib mounting are 80 ft to 180 ft.
- The total load that can be lifted by the upper boom point is: the rated load for the boom (without upper boom point installed) minus 320 lb; however, the upper boom point rated load should not exceed 17,000 lb.
- An upper boom point cannot be used on a 200 ft boom length.

- The boom should be erected over the front of the crawlers, not laterally. When erecting and lowering the boom with a length of 180 ft with jib, blocking must be placed at the end of the crawlers. See operator's manual for details.
- Least stable position is over the side.
- Maximum hoist load for number of reeving parts of line for hoist rope.

Maximum load for main boom

No. of parts of line	1	2	3	4	5
Maximum loads lb	17,000	34,000	51,000	64,000	85,000

No. of parts of line	6	7	8	9	10
Maximum loads lb	102,000	119,000	136,000	153,000	160,000

Maximum load for fixed jib

No. of parts of line	1	2
Maximum loads lb	17,000	24,000

Maximum load for upper boom point

No. of parts of line	1
Maximum loads lb	17,000

- Lifting capacities listed apply only to the machine as originally manufactured for and supplied by Manitowoc Cranes, Inc. Modifications to this machine or use of equipment other than that specified can reduce operating capacity.
- Designed and rated to comply with ASME Code B30.5.

Operation of this equipment in excess of rated loads or disregard of instruction voids the warranty.

Boom combinations

No. 8000-1 heavy-lift boom combinations

Boom length ft	Boom inserts		
	10 ft	20 ft	40 ft
50	1	–	–
60	2	–	–
70	1	1	–
80	2	1	–
90	1	2	–
100	2	2	–
110	1	1	1*
120	2	1	1*
130	1	2	1*
140	2	2	1*
150	1	1	2*
160	2	1	2*
170	1	2	2*
180	2	2	2*
190	1	1	3*
200	2	1	3*

* NOTE: One 40 ft boom insert with lug 40A is required for fixed jib. When no jib is installed a 40 ft boom can be used instead of 40A.

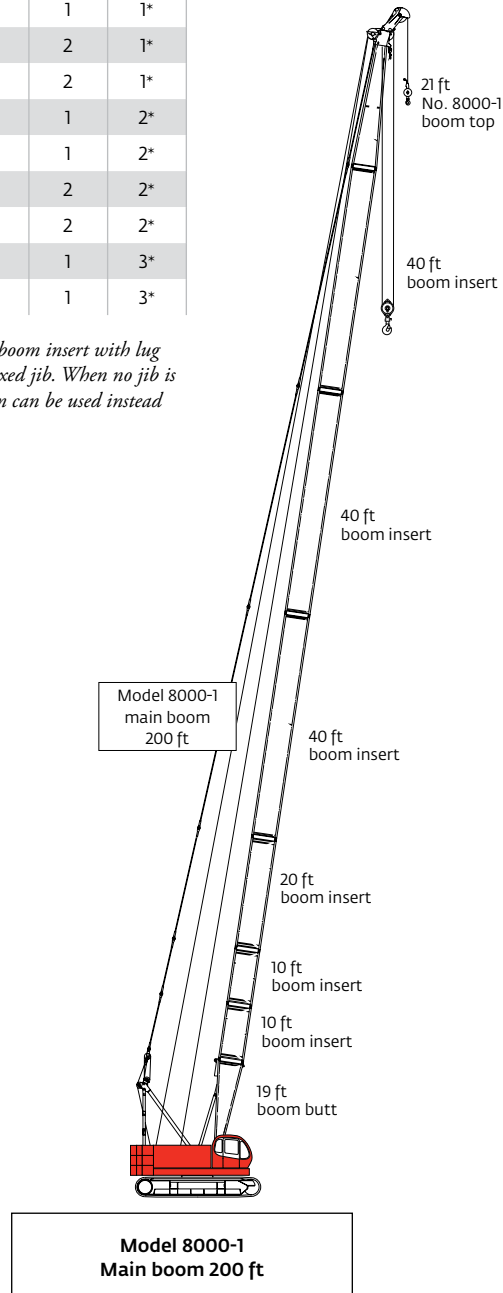

Boom combinations

No. 8000-1 fixed jib combinations		
Fixed jib length ft	Fixed jib inserts	
	10 ft	20 ft
30	-	-
40	1	-
50	-	1
60	1	1

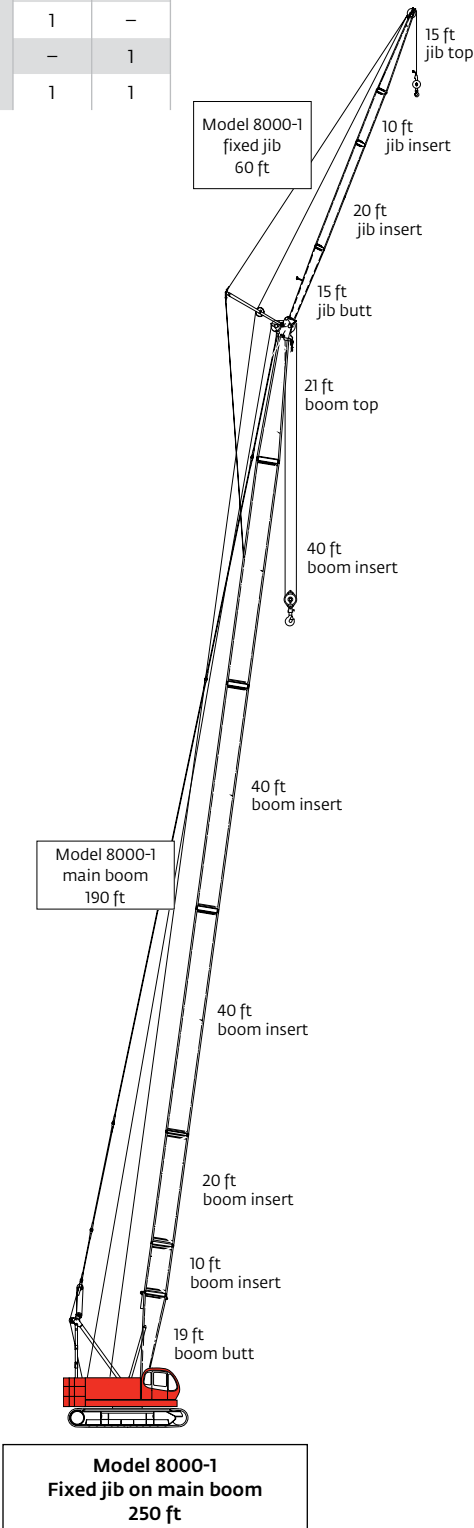

Heavy-lift boom range diagram

No. 8000-1 main boom

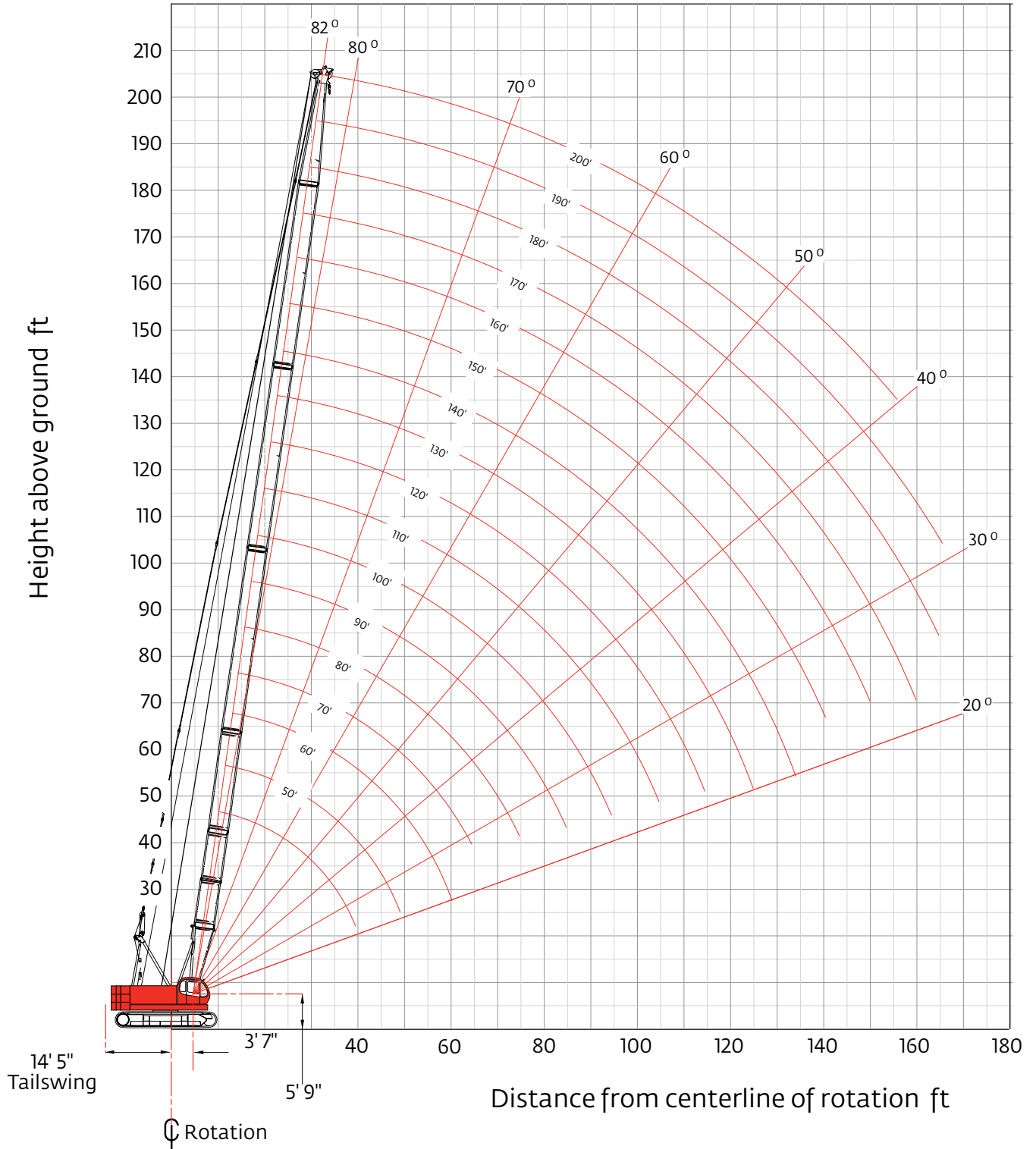

Heavy-lift boom load charts

Model 8000-1 liftcrane boom capacities - 8000-1 main boom

57,584 lb crane counterweight
 14,330 lb carbody counterweight crawler extended

360° Rating lb x 1 000

Boom ft	50	60	80	100	120	140	160	180	190	200
Radius										
12	160.0*									
14	144.0*	143.8*								
16	126.9*	126.7	126.3*							
18	113.2*	113.0	112.6*							
20	97.4	97.1	96.9	96.8*						
24	73.8	73.6	73.3	73.1	73.0*	61.7*				
28	59.2	58.9	58.7	58.4	58.3	57.9	44.0*			
34	45.5	45.2	44.8	44.5	44.3	44.0	42.1*	32.6*	28.8*	25.7*
40	36.8	36.4	36.0	35.7	35.4	35.1	34.9	31.0*	27.5*	24.4*
45	31.6*	31.2	30.8	30.5	30.2	29.9	29.7	29.2	26.4*	23.3*
55		24.2	23.7	23.3	23.0	22.6	22.4	22.0	22.1	21.3*
75			15.9	15.4	15.0	14.6	14.3	13.9	13.9	13.7
95				11.2	10.7	10.2	10.0	9.5	9.5	9.3
105					9.2	8.7	8.5	8.0	8.0	7.8
115					8.1	7.6	7.2	6.7	6.8	6.5
125						6.6	6.2	5.7	5.7	5.4
135						5.9	5.4	4.7	4.8	4.5
145							4.7	4.0	4.0	3.7
155								3.3	3.3	3.0
170								2.6	2.5	

For complete chart, refer to www.cranelibrary.com.

Meets ASME B30.5 Requirements - Capacities do not exceed 75% of static tipping load.
 NOTICE: This capacity chart is for reference only and must not be used for lifting purposes.

Fixed jib range diagram

No. 8000-1 fixed jib on main boom

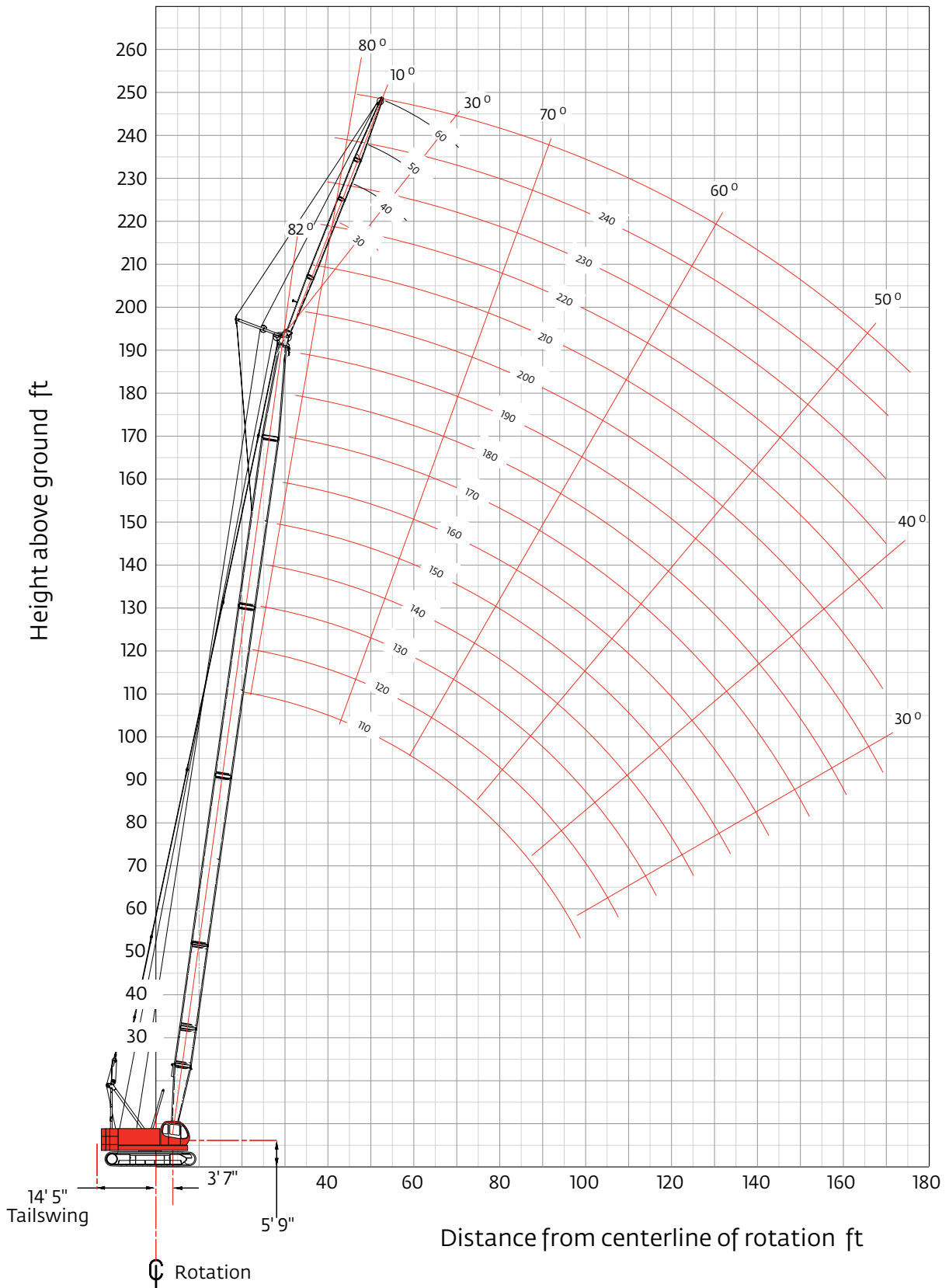

Fixed jib load charts

Model 8000-1 liftcrane jib capacities No. 8000-1 fixed jib on main boom

57,584 lb crane counterweight, 14,330 lb carbody counterweight crawler extended
360° Rating lb x 1000

		10° Offset					30° Offset				
		80	100	130	160	180	80	100	130	160	180
Jib length 30 ft	Boom ft										
	Radius										
	30	24.0*									
	40	24.0*	24.0*	24.0*			19.7*				
	50	24.0*	24.0*	24.0*	24.0*	19.7*	17.6*	18.5*	19.6		
	60	21.3	20.8	20.3	19.7	18.7*	15.9*	16.9*	18.0*	18.9*	18.5*
	80	14.4	13.9	13.3	12.7	12.3	13.7*	14.3*	13.7	13.2	12.9
	100	10.6	10.0	9.4	8.8	8.3			9.7	9.1	8.7
	120			6.9	6.2	5.8				6.5	6.1
	140			5.2	4.4	3.7					4.0
	150				3.6	2.9					
	160				2.9						
	170										

		10° Offset					30° Offset				
		80	100	130	160	180	80	100	130	160	180
Jib length 40 ft	Boom ft										
	Radius										
	30										
	40	24.0*	24.0*								
	50	22.1*	24.0*	24.0*	22.8*		14.4*	15.1*			
	60	18.8*	20.9*	20.5	20.3*	17.8*	12.9*	13.6*	14.5*	15.1*	
	80	14.5*	14.1	13.5	12.9	12.5	10.9*	11.6*	12.5*	13.2*	13.5*
	100	10.7	10.2	9.5	8.9	8.5		10.3*	10.0	9.6	9.3
	120		7.6	7.0	6.4	5.9			7.4	6.9	6.5
	140			5.2	4.5	3.9				5.0	4.5
	150			4.6	3.7	3.1				3.6	
	160				3.0						
	170										

For complete chart, refer to www.cranelibrary.com.

Meets ASME B30.5 Requirements - Capacities do not exceed 75% of static tipping load.
NOTICE: This capacity chart is for reference only and must not be used for lifting purposes.

Fixed jib load charts

Model 8000-1 liftcrane jib capacities No. 8000-1 fixed jib on main boom

57,584 lb crane counterweight, 14,330 lb carbody counterweight crawler extended
360° Rating lb x 1 000

		10° Offset					30° Offset				
		80	100	130	160	180	80	100	130	160	180
Jib length 50 ft	Boom ft										
	Radius										
	30	20.0*									
	40	20.0*	20.0*								
	50	18.5*	20.0*	20.0*							
	60	15.6*	17.2*	19.3*	19.2*	17.0*					
	80	12.0*	13.3*	13.6	13.1	12.7*					
	100	9.7*	10.3	9.7	9.1	8.7					
	120	8.6*	7.7	7.1	6.5	6.0					
	140			5.7	4.6	4.0					
	150			4.6	3.1	3.2					
	160			4.0							
	170										

		10° Offset					30° Offset				
		80	100	130	160	180	80	100	130	160	180
Jib length 60 ft	Boom ft										
	Radius										
	30										
	40	18.0*									
	50	16.3*	17.6*	18.0*							
	60	13.7*	15.0*	16.7*	17.8*	15.0*					
	80	10.4*	11.5*	13.0*	13.2	12.8*					
	100	8.3*	9.3*	9.7	9.1	8.7					
	120	7.0*	7.8*	7.1	6.5	6.1					
	140		6.0	5.4	4.7	4.1					
	150			4.7	3.9	3.3					
	160			4.0	3.1	2.5					
	170			3.4	2.5						

For complete chart, refer to www.cranelibrary.com.

Meets ASME B30.5 Requirements - Capacities do not exceed 75% of static tipping load.
NOTICE: This capacity chart is for reference only and must not be used for lifting purposes.

Clamshell

Boom:

Welded lattice construction using tubular, high-tensile steel chords with pin connections between sections.

Basic boom length: 50 ft

Max. boom length: 70 ft

Limit on clamshell bucket weight: (4,600 lb)

Maximum component chart

Boom length ft	Boom arrangement
50	Base-A-Tip
60	Base-A-A-Tip, Base-B-Tip
70	Base-A-B-Tip

Base = 20 ft

Insert: A = 10 ft

B = 20 ft

Tip = 20 ft

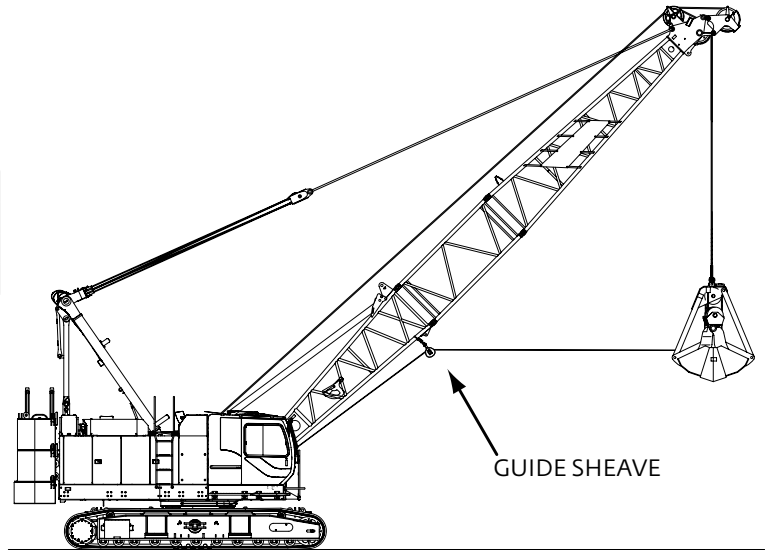

1. Figures represent maximum allowable capacity, and assume level ground and ideal working conditions.
2. Capacities are calculated at 66% of the minimum tipping loads.
3. Capacities are maximum recommended by PCSA Standard #4. Allowances must be made by the user for such unfavorable conditions as a soft or uneven supporting surface, rapid cycle operations, or bucket suction.
4. The combined weight of the bucket and load must not exceed these capacities.
5. Boom length for clamshell operation should not exceed 70 ft.

Clamshell Capacities

19.5 USt counterweight
(three upper counterweights,
crawlers extended)

lb x 1 000

Boom ft	50	60	80
Radius			
22			
26	16.0*		
30	16.0*	16.0*	
36	16.0*	16.0*	16.0*
40	16.0*	16.0*	16.0*
46	16.0*	16.0*	15.6*
50		14.5*	14.3*
56		12.3	12.3*
60			11.2*
66			9.7*

*Ratings shown by * are determined by the strength of the boom or other structural components.*

Manitowoc Crane Care

Crane Care is Manitowoc's comprehensive service and support program. It includes classroom and on-site training, prompt parts availability, expert field service, technical support and documentation.

That's commitment you won't find anywhere else.

That's Crane Care.

Service training

Manitowoc specialists work with you in our training centers and in the field to make sure you know how to get maximum performance, reliability and life from your cranes.

Manitowoc Cranes Technical Training Centers provide valuable multi-level training, which is available for all models and attachments, in the following format:

- **Intro to Canbus and Canbus 1, 2, 3**
- **Intro to EPIC and EPIC 1, 2, 3**
- **Small Crawler 1**
- **Canbus 1 and 2 assembly, operation and maintenance**
- **EPIC 1 and 2 assembly, operation and maintenance**

Refer to www.manitowoc.com for course descriptions.

Parts availability

Genuine Manitowoc replacement parts are accessible through your distributor 24 hours a day, 7 days a week, 365 days a year.

Service interval kits

200 hour kit

1,000 hour kit

2,000 hour kit

Hydraulic test kit

U.S. standard tools kit

Field service

Factory-trained service experts are always ready to help maintain your crane's peak performance.

For a worldwide listing of dealer locations, please consult our website at: www.manitowoc.com

Technical support

Manitowoc's dealer network and factory personnel are available 24 hours a day, 7 days a week, 365 days a year to answer your technical questions and more, with the help of computerized programs that simplify crane selection, lift planning, and ground-bearing calculations.

For a worldwide listing of dealer locations, please consult our website at: www.manitowoc.com

Technical documentation

Manitowoc has the industry's most extensive documentation; available in major languages and formats that include print, videotape, and DVD/CD.

Additional copies available through your Authorized Manitowoc Distributor.

- Crane operator's manual
- Crane parts manual
- Crane capacity manual
- Crane vendor manual
- Crane service manual
- Luffing jib operator's/parts manual
- Capacity chart manual - attachments

Available from your Authorized Manitowoc Cranes Distributor, these videos are available in NTSC, PAL, SECAM, and DVD formats.

- Your Capacity Chart Video
- Respect the Limits Video
- Crane Safety Video
- Boom Inspection/Repair Video

Crane Care Package

Manitowoc has assembled all of the available literature, CD's and videos listed above plus several Manitowoc premiums into one complete Crane Care Package, which is supplied to the owner of each new crane.

Manitowoc Cranes

Regional headquarters

Americas

Manitowoc, Wisconsin, USA

Tel: +1 920 684 6621

Fax: +1 920 683 6277

Shady Grove, Pennsylvania, USA

Tel: +1 717 597 8121

Fax: +1 717 597 4062

Europe, Middle East, Africa

Ecully, France

Tel: +33 (0)4 72 18 20 20

Fax: +33 (0)4 72 18 20 00

China

Shanghai, China

Tel: +86 21 6457 0066

Fax: +86 21 6457 4955

Greater Asia-Pacific

Singapore

Tel: +65 6264 1188

Fax: +65 6862 4040

Regional offices

Americas

Brazil

Alphaville

Mexico

Monterrey

Chile

Santiago

Europe, Middle East,

Africa

Czech Republic

Netvorice

France

Baudemont

Cergy

Decines

Germany

Langenfeld

Hungary

Budapest

Italy

Lainate

Netherlands

Breda

Poland

Warsaw

Portugal

Baltar

Russia

Moscow

South Africa

Johannesburg

U.A.E.

Dubai

U.K.

Buckingham

China

Beijing

Chengdu

Guangzhou

Xian

Greater Asia-Pacific

Australia

Brisbane

Melbourne

Sydney

India

Chennai

Delhi

Hyderabad

Pune

Korea

Seoul

Philippines

Makati City

Singapore

Factories

Brazil

Passo Fundo

China

TaiAn

Zhangjiagang

France

Charlieu

Moulins

Germany

Wilhelmshaven

India

Pune

Italy

Niella Tanaro

Portugal

Baltar

Fânzeres

Slovakia

Saris

USA

Manitowoc

Port Washington

Shady Grove

This document is non-contractual. Constant improvement and engineering progress make it necessary that we reserve the right to make specification, equipment, and price changes without notice. Illustrations shown may include optional equipment and accessories and may not include all standard equipment.