

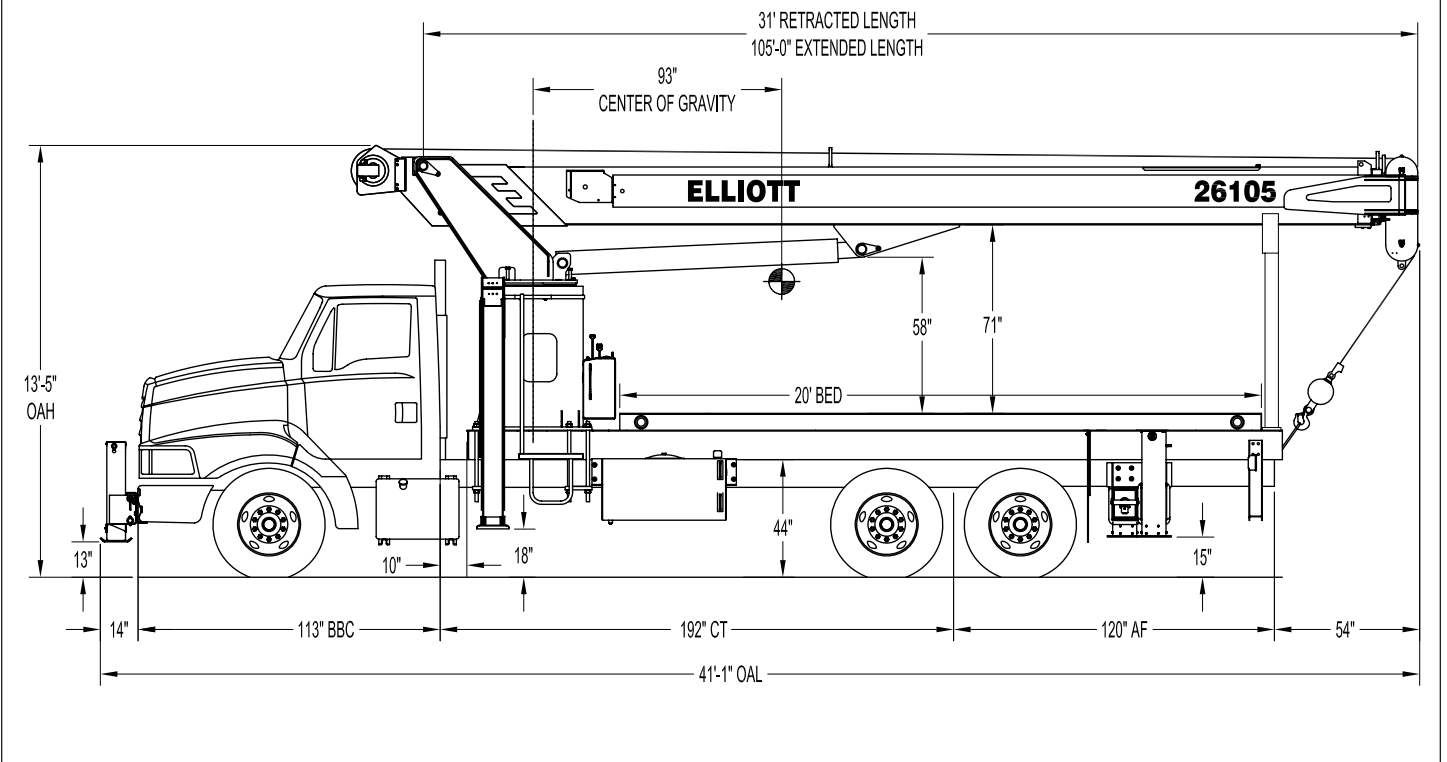

26105F SIDE VIEW DIAGRAM



- | | | | |
|---------------------------------|-------------------------------------|---------------------------------|--------------------------------|
| • Maximum Vertical Reach | 162' / 49,4 m | • Powered Boom Sections | 4 |
| • Working Area | 180 Degrees Standard (360 Optional) | • Overall Height | 13'5" / 4,1 m |
| • Lifting Capacity | 52,000 lbs / 23 587 kg | • Operator Controls | Dual Operator Standup Controls |
| • Boom Length | 105' / 32 m | • Outrigger Type Front | A-Frame |
| • Crane Weight (Dry) | 26,040 lbs / 11 811 kg | • Outrigger Spread Front | 20'10" / 6,3 m |
| • Jib Length | 26', 26'-45' / 8 m, 8-13,7 m | • Outrigger Type Rear | Out-Down |
| • Winch Bare Drum Pull | 12,800 lbs / 5806 kg | • Outrigger Spread Rear | 18'2" / 5,5 m |

TECHNICAL SPECIFICATIONS

Crane Capacity: 52,000 lbs at 5' load radius.

Maximum Tip Height: 117' height (162' with optional 45' jib)

Control Console: Rotating turret dual operator standup control station equipped with four single axis control levers for the main crane controls. Operator station includes LMI display, bubble level gauge, engine start/stop switch, signal horn button, variable foot throttle, lifting capacity chart, range diagram chart, boom angle indicator, system pressure gauge, 12V DC power source, and cup holder. Outrigger lever controls at control consoles.

Boom: Four-section fully proportional, high strength steel plated rectangular tube sections. A maximum boom tip height of 117' mounted on a truck. The boom nose contains one floating upper sheave and three lower sheaves. Assembly includes heavy-duty cylinder fittings, pivot pins, and replaceable wear pads.

Winch: Mounted at the base of the boom for a long fleet angle and flat level spooling of cable. Winch is driven by a planetary reducer and powered by a hydraulic motor. Burst-of-speed winch provides increased line speed. The winch brake is spring applied, pressure release design. Supplied with 425' of 9/16" diameter rotation resistant wire rope with a single line pull of 9,060 pounds, and a downhaul ball with swivel hook for single part line.

Load Moment Indicator System: System senses hoist cylinder pressures, boom length and boom angle with hydraulic function lockout. The display console is equipped with a bar graph showing crane utilization, boom angle or boom length, a mode select controls for main boom and jib operation, and an anti-two block with an audio/visual warning and shut-off functions to limit hook-boom point contact.

Elliott Equipment Company reserves the right to change the specification of any unit at any time without prior notice. This brochure is only a statement of general specifications on the date of this publication. For more detailed info on specific Elliott trucks go to www.elliottequip.com

Outriggers: One sets of "A" Frame mian outriggers with 20'10" span, and one set of out and down overframe rear outriggers with 18'2" span.

Frame: Full length, all welded rigid 4-plate design sub-frame. Sub-frame allows for bolt-on addition of 20' bed.

Turret: Reverse offset turret is one-piece weldment. Turret rotates on large diameter ball bearing.

Rotation: Hydraulic motor drives turret through double reduction planetary swing drive for 372-degree non-continuous rotation. The swing drive system has a spring applied, pressure release brake.

Lift: One double-acting long stroke cylinder provides smooth and stable boom elevation. Holding valve prevents boom from falling in event of hose failure.

Boom Extension: Incorporates a 2-stage hydraulic extension cylinder, attached to the largest boom section, with a proportional cable extension system driving the outermost sections.

Hoses: All high pressure hoses are wire braid reinforced with a minimum safety factor of 4 to 1.

Cylinders: All cylinders use microhoned cylinder tubing, chrome shafts, top grade packing and protective rod wipers. Cylinder-mounted holding valves provided on all load-holding cylinders.

Hydraulic System: Equipped with cable-shift PTO, three-section gear pump, SAE O-ring face seals on pressure lines, and a 10-micron return line filter. The control valve distributes all flow to hoist system, swing circuit, and other crane functions. System is open center type.

Oil Tank Capacity: 120 gallon mounted to truck frame on roadside.

Cab Equipment: PTO switch with indicator lights installed in truck cab. U/L approved 5:BC dry chemical fire

extinguisher installed in truck cab.

Operators Manual & Video: Two CD copies and one hard copy of operation, maintenance, safety and parts manual provided with each unit. Operational and safety video provided at delivery.

Installation: Unit installed on chassis, painted, system and tank filled with oil, tested, inspected, and ready to operate.

Standard Paint: Paint turret and boom white, outriggers red, and bed and boxes black.

Bumper: Bureau of Motor Carrier Safety rear bumper.

Weight: Approximately 26,040 lbs. with 20' steel-floor bed less truck.

Truck Chassis Required: Approx. 192" C.T. RBM 1,749,000 in-lb. per rail, 20,000 lb. front axle and 60,000 lb. GVWR required. Trucks must have front frame extension, 12V electrical system with high capacity alternator, cab clearance stop/tail/backup lights, and I.D. lamps. Recommended GVWR is minimum for BoomTruck with flatbed only. Contact factory when additional equipment is to be added.

Options:

26'-45' Telescopic Pin-On Jib.

Radio Remote Controls.

Superlink Short Jack Outriggers.

2 Person Gravity Leveled Steel Basket.

Front Jack for 360 Degree Crane Operation.

Rotation Resistant Wire Rope.

Hydraulic Tool Circuits on Bed.

Much More...

LOAD CHART - MAIN BOOM, FULL-SPAN OUTRIGGERS

MAIN BOOM LOAD RATINGS WITH FULLY EXTENDED OUTRIGGERS

LOAD RADIUS IN FEET	LOADED BOOM ANGLE	A		B		C		D		E		F		
		31-FT.	46-FT.	46-FT.	58-FT.	70-FT.	82-FT.	94-FT.	105-FT.					
5	80	52,000												
6	78	44,000												
8	74	36,600	79.5	30,000										
10	70	31,000	77	27,000	80	20,000								
12	66	26,500	74.5	24,900	78	19,800								
14	61.5	20,500	72	21,800	76	17,700	79.5	18,500						
16	57	18,500	69	19,500	74	16,000	77.5	16,000						
18	52	15,900	66	15,800	72	14,400	76	14,800	78.5	13,700				
20	47	14,300	63	12,800	69.5	11,500	74	13,400	77	12,500	79.5	11,500		
25	30.5	10,300	55.5	11,000	64.5	9,500	69.5	10,900	73.5	10,300	76	9,750	78.5	8,400
30			47.5	9,300	58.5	7,950	65.5	9,000	70	8,500	72.5	8,050	75.5	7,600
35			37.5	8,500	52.5	6,700	60.5	7,500	66	7,050	70	6,650	72.5	6,200
40			23	6,300	45.5	5,600	55.5	6,300	62	5,800	66.5	5,600	69.5	5,300
45					37	4,000	50	5,300	57.5	5,000	63	4,700	66.5	4,550
50					26.5	3,850	44	4,600	53	4,400	59	4,300	63.5	3,900
55							37	3,800	48.5	3,800	55.5	3,800	60	3,450
60							28.5	2,700	43	3,250	51.5	3,300	56.5	3,000
65							15.5	2,150	37	2,700	47	2,800	53	2,700
70									30	2,150	42.5	2,250	49.5	2,350
75									20.5	1,800	37	1,900	45.5	1,850
80											30.5	1,000	41	1,450
85											23	600	36	1,150
90													30.5	850
0		5,500	0	2,900	0	1,100	0	500						
DEDUCTIONS FOR STOWED JIB (lbs)		850		600		450		400		350		300		250
		550		350		300		250		200		150		150

JIB LOAD RATINGS WITH FULLY EXTENDED OUTRIGGERS

26-ft FIXED LENGTH JIB			26'-45' TWO SECTION JIB			
LOAD RADIUS IN FEET	LOADED BOOM ANGLE	26-ft JIB	RETRACTED 26' JIB		EXTENDED 45' JIB	
			LOAD RADIUS IN FEET	LOADED BOOM ANGLE	26-ft JIB	LOADED BOOM ANGLE
30	78.5	4,400	30	78.5	4,150	
35	76.5	4,000	35	76	3,750	77
40	74	3,600	40	74	3,350	75.5
45	72	3,100	45	71.5	2,850	74
50	69.5	2,700	50	69	2,450	72
55	67	2,300	55	66.5	2,050	70
60	64.5	2,000	60	64	1,750	68
65	62	1,700	65	61.5	1,450	66
70	59	1,500	70	59	1,250	64
75	56.5	1,300	75	56	1,050	61.5
80	53.5	1,100	80	53.5	850	59.5
85	50.5	900	85	50.5	650	57
90	47.5	700	90			55
			95			52

NOTICE

- DO NOT DEADHEAD LINE BLOCK AGAINST BOOM TIP WHEN EXTENDING BOOM.
- KEEP AT LEAST 5 WRAPS OF LOADLINE ON THE WINCH DRUM AT ALL TIMES.
- USE ONLY 9/16" DIAMETER WIRE ROPE, AS SPECIFIED BELOW, WITH THE PROPER BREAKING STRENGTHS LISTED.
- ANTI-TWO-BLOCK SYSTEM MUST BE IN GOOD OPERATING CONDITION BEFORE OPERATING CRANE. SEE OPERATION & SAFETY MANUAL.

DEDUCTIONS FOR STOWED EXTENDABLE JIB (lbs)
DEDUCTIONS FOR STOWED FIXED LENGTH JIB (lbs)

1-PART LINE



MAX PULL: 9,060 lbs

2-PART LINE



18,120 lbs

3-PART LINE



27,180 lbs

4-PART LINE



36,240 lbs

5-PART LINE



45,300 lbs

6-PART LINE



52,000 lbs

ELLIOTT EQUIPMENT CO. SUPPLIED
LOADLINE EQUIPMENT DEDUCTIONS:
DOWNHAUL WEIGHT180 lbs
ONE SHEAVE BLOCK.....375 lbs
TWO SHEAVE BLOCK.....640 lbs
THREE SHEAVE BLOCK.....870 lbs
AUXILIARY SHEAVE.....100 lbs

9/16" -SPIN RESISTANT 5:1 S.F.) 45,300-lbs.
BREAKING STRENGTH

CRANE MEETS ASME B30.5 REQUIREMENTS AT TIME OF MANUFACTURE

DO NOT PRINT OVER ANY LABELS 1113370 07106

RANGE CHART - MAIN BOOM + JIB , FULL-SPAN OUTRIGGERS

RANGE DIAGRAM WITH FULL SPAN OUTRIGGERS

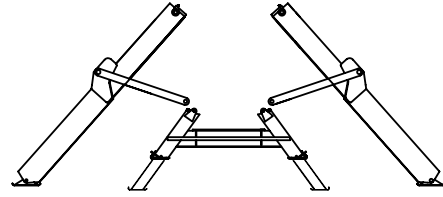
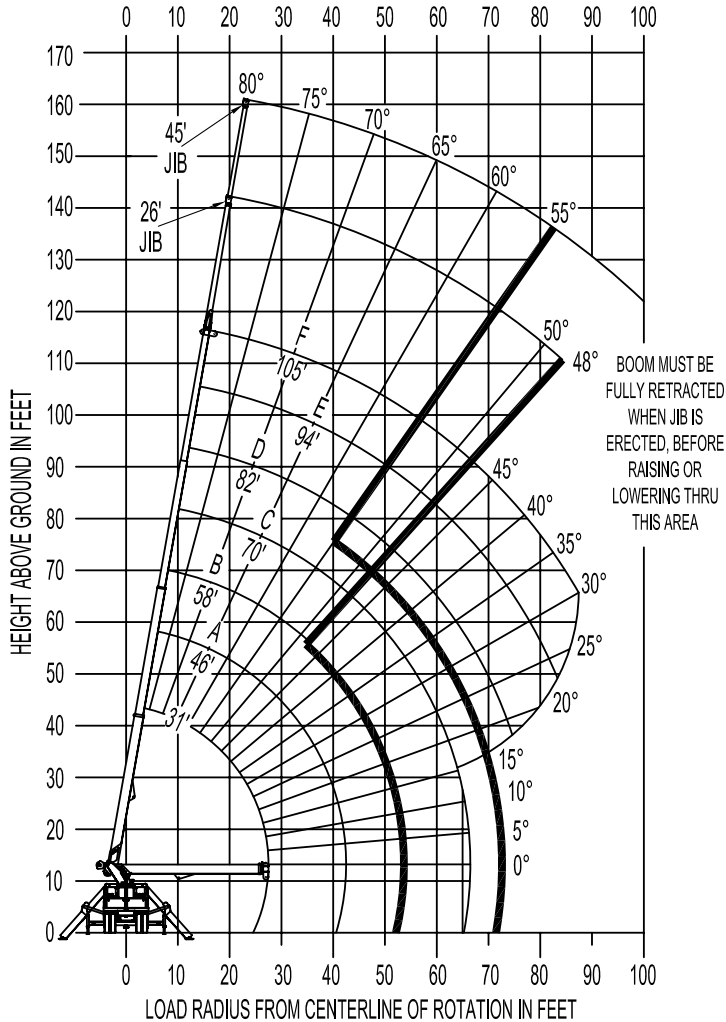

OUTRIGGERS AT FULL EXTENSION

NOTE:

1. OPERATE JIB BY RADIUS WHEN MAIN BOOM IS FULLY EXTENDED. INCREASE BOOM ANGLE IF NECESSARY TO MAINTAIN LOAD RADIUS.
2. WHEN BOOM IS RETRACTED, OPERATE JIB BY BOOM ANGLE. DO NOT EXCEED ANY RATED JIB CAPACITIES AT REDUCED BOOM LENGTHS.
3. CAPACITIES DO NOT EXCEED 85% STABILITY.
4. PERSONNEL HANDLING IS ALLOWED ONLY WITH FULL SPAN OUTRIGGERS
5. LOAD RATINGS ABOVE BOLD LINE ARE STRUCTURALLY LIMITED.
6. BOOM LOAD RATINGS ARE BASED ON LOADED BOOM RADIUS.
7. LOADED BOOM ANGLES ARE GIVEN AS A REFERENCE ONLY.

AREA OF OPERATION

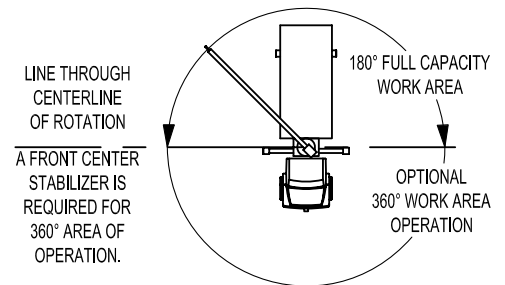

CHASSIS SPECIFICATIONS

	26105F BoomTruck
Wheelbase (WB)	256" / 650 cm
Cab to Tandem (CT)	192" / 488 cm
Cab to End of Frame (EOF)	312" / 792 cm
Frame Section Modulus	30.0 in3-110,000 psi / 492 cm3-758,428 kPa
Front Axle Gross Weight Rating	20,000 lb / 9072 kg
Rear Axle Gross Weight Rating	40,000 lb / 18144 kg
Integral Front Frame Rails	Required for Front Stabilizer

Chassis data is minimum general requirements-not for engineering.
 Actual dimensions and truck data will depend on truck selection and axle configuration.
 *Minimum chassis weight is required to meet 85% stability requirements.

OPTIONS



Radio Remote Control

Interference protected radio remotes let you get closer to your work and have full control over your machine. Includes battery charging feature and optional LMI screen.

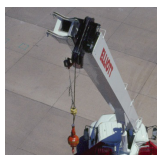

Pin-On Jib Attachments

One piece & two piece telescoping or fixed jibs that stow on the side of the boom for easy placement while on the worksite.



Continuous Boom Rotation

Add the convenience of 360 degree continuous rotation by adding a special boom rotation system for rotation without stops.



Digger / Auger Attachment

Dig faster and deeper with Elliott's auger attachment, offering 44' of digging range and a hydraulically powered auger that stows on the boom.



Tool Boxes

Optional tool boxes and bed storage can accommodate any storage need for tools, work materials and more.

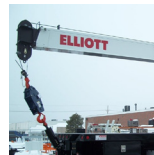

Hook Block for Multi-Part Line

Elliott can install a 2-3 part hook block or a 4 part-hook block to improve lifting capabilities. The block can be stored at the rear of the bed.

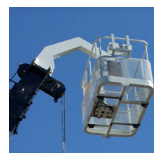

Gravity Levelled Basket

Elliott's pin-on work platform pins onto the boom for easy installation and removal. Gravity leveling and mechanical rotation makes it a great accessory for any worksite.



Body Mounted Hose Reels and Circuits

Let us work with you to customize your tool compatibility by adding hose reels or hydraulic circuits to the crane bed.