

model 999



product guide

features

- 250 mton (275 ton) capacity
- 1 115 mton-m (8,268 ft-kips) Maximum Load Moment
- 88,4 m (290') Heavy-Lift Boom
- 103,6 m (340') Long-Reach Boom
- 100,6 m (330') Fixed Jib on Heavy-Lift Boom
- 115,8 m (380') Fixed Jib on Long-Reach Boom
- 128,0 m (420') Luffing Jib
- 146,3 m (480') Fixed Jib on Luffing Jib
- 291 kW (390 HP) engine
- EPIC® controls
- 134 m/min (440 fpm) line speed standard
- 131 kN (29,500 lb) line pull standard
- 13 600 kg (29,500 lb) Clamshell capacity
- 9 100 kg (20,000 lb) Dragline capacity
- 999 MAX-ER™ attachment
- 999 RINGER® attachment
- Fast, efficient self-assembly and disassembly
- Complete crane, maximum boom, fixed jib and counterweight ships on only 12 trucks
- Heaviest module weight of 39 689 kg (87,500 lb) maximum module width of 3,0 m (10')
- Manitowoc CraneCARESM comprehensive support

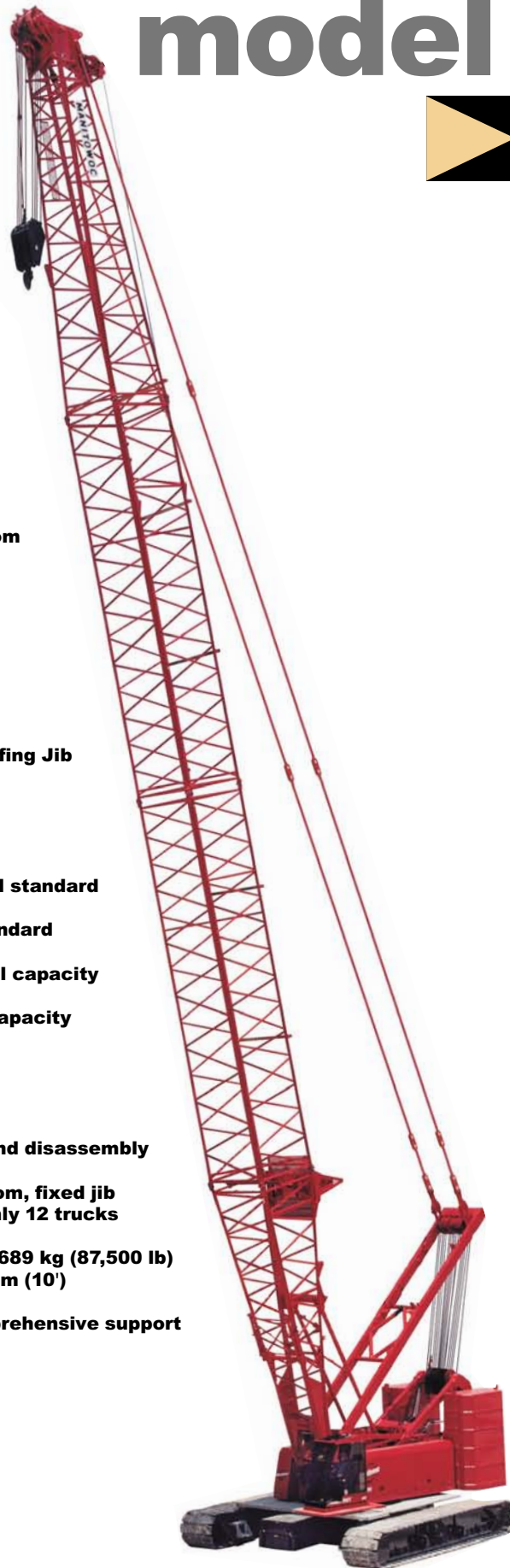

contents

Specifications	3
Outline Dimensions	9
Transport / Assembly	19
Performance Data	22
Boom Combinations	36
Main & Long-Reach Range / Load Charts	42
Fixed Jib Range / Load Charts	50
Luffing Jib Range / Load Charts	65
Fixed Jib on Luffing Jib Range / Load Charts	74
MAX-ER™	79
RINGER® Range / Load Charts	80
CraneCARE SM	88

Manitowoc

index

2

	Specifications	Outline Dimensions and Weights	Wire Rope Lengths	Wire Rope Specifications	Boom Raising	Boom Combinations	Range Diagram and Capacity Charts
No. 999 Basic Crane	3	9-10					
Engine(s)	3						
Hydraulic System	3						
Drums	3, 32						
Boom Hoist	4, 32						
Swing System	4						
Mast and Gantry	4						
Counterweights	4	10-11					
Operator's Cab	4						
Carbody	4						
Crawlers	4-5	10					
Optional Equipment							
Boom point	7	18					
Hook block/weight ball	7	18					
Miscellaneous	7-8						
Special Applications							
Clamshell/Dragline	8						
Working Weights	32						
Transport/Assembly	19-21						
CraneCARE SM	88-90						
No. 82 Boom							
Heavy-Lift	5	11-12	22	28-29	33	36	42-43
Heavy-Lift with No. 134 Fixed Jib	5	14	22	28-29	33	36	50-52
Heavy-Lift with No. 135 Luffing Jib	6	15-16	24	30-31	34	40	65-68
Heavy-Lift with No. 149 Luffing Jib	6	16-17	23	30-31	33	41	69-73
Heavy-Lift with No. 138 Fixed Jib on No. 135 Luffing Jib	6	17	24	30-31	34	40	74-77
Heavy-Lift with No. 134 Fixed Jib on No. 149 Luffing Jib	6			30-31	33	41	78
Long Reach	5	12	25	28-29	35	37	44-45
Long Reach with No. 123 Fixed Jib	5	15	25	28-29	35	37	53-55
Long Reach with No. 134 Fixed Jib	5		25	28-29	35	37	56-58
No. 22E Boom							
Heavy-Lift	5	13	22	28-29	33	36	42-43
Heavy-Lift with No. 134 Fixed Jib	5		22	28-29	33	36	50-52
Heavy-Lift with No. 135 Luffing Jib	6		24	30-31	34	40	65-68
Heavy-Lift with No. 138 Fixed Jib on No. 135 Luffing Jib	6		24	30-31	34	40	74-77
Open Throat Top	5	13	26	28-29	35	38	46-47
Open Throat Top with No. 123 Fixed Jib	5		26	28-29	35	38	59-61
Light Tapered Top	5	14	27	28-29	35	39	48-49
Light Tapered Top with No. 123 Fixed Jib	5		27	28-29	35	39	62-64
MAX-ER	6					79	
RINGER	6-7	80					
No. 67B Main Boom						81	82-83
No. 67B Boom with 49A-44 Luffing Jib						81	84-87

specifications

3

Upperworks



Engine

Cummins Model QSM11 diesel, 6 cylinder, 280 kW (375 BHP) @ 2100 governed RPM.

Caterpillar Model 3176 diesel, 6 cylinder, 291 kW (390 BHP) @ 2100 governed RPM.

Includes engine block heater (120 V), ether starting aid, manually operated disconnect clutch for cold weather starting, high silencing muffler, hydraulic oil cooler, radiator and fan.

Multiple hydraulic pump drive transmission provides independent power for all machine functions.

Two 12 volt maintenance-free, Group 8D batteries, 1400 CCA at -18°C (0° F), 24 volt starting and 120 amp alternator.

Optional: consult factory for other available engines.

One 644 l (170 gal) capacity diesel fuel tank, mounted on rear of upperworks, with level indicator in operator's cab.



Controls

Modulating electronic-over-hydraulic controls provide infinite speed response directly proportional to control lever movement. Controls include Manitowoc's exclusive EPIC® *Electronically Processed Independent Control* system providing microprocessor driven control logic, pump control, on-board diagnostics, and service information.

Block-up limit control is standard for hoist and whip lines.

Integrated Load Moment Indicator system (LMI) is standard for main boom and upper boom point. "Function cut-out" or "warning only" operation is available via a keyed switch on the LMI console.

Optional travel and swing alarms are available.

Optional foot controls for travel.



Hydraulic System

Six high-pressure piston pumps are driven through a multi-hydraulic pump transmission. These six pumps provide independent "closed loop" hydraulic power for front drum, rear drum, boom hoist system, swing system, and both left and right crawler operation.

System	kg/cm ² (psi)	lpm (gpm)
Front Drum	422 (6,000)	379 (100)
Rear Drum	422 (6,000)	379 (100)
Boom Hoist	422 (6,000)	227 (60)
Swing System	386 (5,500)	227 (60)
Left Crawler	422 (6,000)	227 (60)
Right Crawler	422 (6,000)	227 (60)
Auxiliary Pump*	422 (6,000)	379 (100)

Optional pump powers auxiliary drum on liftcrane or main hoisting drum on RINGER® attachment.

Hydraulic reservoir capacity is 454 l (120 gal) and is equipped with breather, dipstick, clean out access, and internal diffuser.

Each function is equipped with relief valves to protect the hydraulic circuit from overload or shock.

Replaceable, spin on ten micron (absolute) full flow line filter is furnished in the hydraulic circuit. All oil is filtered prior to return to the hydraulic reservoir.

Hydraulic system also includes pump transmission disconnect clutch & hydraulic oil cooler.



Drums

Two equal width winches 940 mm (37") wide and 540 mm (21-1/4") diameter are driven by independent variable displacement axial piston hydraulic motors through planetary reduction mounted on separate front and rear shafts with anti-friction bearings. Drums are grooved for 26 mm rope.

Powered hoisting/lowering operation is standard with automatic (spring applied, hydraulically released) multi-disc brakes, and drum rotation indicators.

Optional free-fall operation for front and/or rear drum(s). Wet disk brake manually applied by foot pedal with locking latch in operator's cab. Operator may select free-fall or powered lowering mode using a selector switch.

Optional auxiliary (third) hydraulic powered drum rated at 89,0 kN (20,000 lb) line pull mounted in boom butt. Includes third drum control system.

Optional auxiliary drum preparation includes electric wiring, controls, hydraulic pump and plumbing.

Optional bolt-on clamshell/dragline laggings.

Optional wire rope for various applications.

specifications

4



Boom Hoist

Independent boom hoist consists of a 343 mm (13-1/2") wide and 483 mm (19") diameter drum grooved for 22,23 mm (7/8") diameter wire rope. Includes 323,1 m (1,060') of 22,23 mm (7/8") diameter wire rope for 20 part line reeving.

Drum is powered by a fixed displacement hydraulic motor coupled to an internal brake and planetary gearbox equipped with ratcheting pawl.

Boom hoist speed: raise 88,4 m (290') full main boom from 0° - 82° in 2 minutes, 50 seconds.



Mast and Gantry

Moving mast is 9,8 m (32') long and connects the boom hoist reeving to the steel boom suspension strap rigging. When used with optional self-erect package, the mast is utilized for crane assembly and disassembly. It is capable of lifting and positioning the crawler assemblies, stacking the counterweights, and assembling the boom and jib.

Gantry includes gantry raising cylinders capable of lifting the entire upperworks counterweight for removal and installation. Counterweight attaches to rotating bed with power actuated pins.

Air cushioned boom stop and automatic boom stop standard.



Counterweight

QTY.	ITEM	UNIT WEIGHT		TOTAL WEIGHT	
		kg	lb	kg	lb
	Upperworks				
1	Tray	9 572	21,100	9 572	21,100
1	Center Box	10 660	23,500	10 660	23,500
6	Upper Side Box	7 938	17,500	47 628	105,000
SERIES 1 TOTAL				67 860	149,600
	Upperworks				
2	Upper Side Box	7 938	17,500	15 876	35,000
	Carbody				
2	Lower Box	9 978	22,000	19 956	44,000
Optional: Add to SERIES 1 for SERIES 2 TOTAL				103 690	228,600
	Upperworks				
2	Upper Side Box	7 938	17,500	15 876	35,000
	Carbody				
2	Upper Box	8 165	18,000	16 330	36,000
Optional: Add to SERIES 2 for SERIES 3 TOTAL				135 896	299,600

Includes connecting pins, brackets, and stops.

Optional low-profile counterweight boxes for Series 3 only. Consists of twelve 6 622 kg (14,600 lb) upper side counterweight boxes in lieu of the standard ten 7 938 kg (17,500 lb) counterweight boxes. Low profile boxes allow

greater versatility for transport of boom and counterweight sections where specific markets have transport restrictions.



Swing System

High strength fabricated steel alloy rotating bed is mounted on 2,76 m (108-9/16") diameter turntable triple-row ball bearing.

Independent swing powered by a fixed displacement hydraulic motor coupled to a planetary gearbox with internal brake. 360° positive swing lock.

Swing system maximum speed: 1.8 rpm.



Operator's Cab

Fully enclosed and insulated steel module located on a pivoting mount at the left front corner of rotating bed, allowing module repositioning for transportation. Module is equipped with sliding door, large safety glass windows on all sides and roof. Signal horn, cab space heater, front and roof windshield wipers, dome light, sun visor and shade, fire extinguisher and air circulating fan are standard.

- Optional air conditioner.
- Optional nylon protective window covers.

Lowerworks



Carbody

Connects rotating bed to crawler assemblies. High strength fabricated steel assembly with FACT™ connection system for fast installation and removal of crawler assemblies.



Crawlers

Crawler assemblies are 8,59 m (28' 3") long with 1,22 m (48") wide cast steel crawler pads and sealed "low maintenance" intermediate rollers. Each crawler is identical and can be mounted on either side of the carbody. Each crawler is powered independently by a variable displacement hydraulic motor and includes two hydraulically powered pin actuators for fast installation and removal from carbody. Carbody mounted drive motors are connected to crawler final reduction via telescoping shafts. This permits crawlers to be removed without opening their hydraulic circuits. Crawlers provide

specifications

5

ample tractive effort that allows counter rotation with full rated load. Maximum ground speed of 1,61 kph (1.0 mph).

Optional Self-Erect system includes: carbody jacking cylinders with pads, controls, 41 mton (45 ton) assembly block, boom-butt installation support, and crawler handling chains.

Attachments



No. 82 Heavy-Lift Main Boom

The liftcrane is equipped with a 21,3 m (70') No. 82 basic heavy-lift angle chord boom consisting of a 9,1 m (30') butt and 12,2 m (40') top with eight 76,2 cm (30") diameter roller bearing sheaves on one shaft. Includes rope guides, boom hoist wire rope, and boom angle indicator. The No. 82 boom utilizes steel suspension straps and Manitowoc's patented, exclusive FACT™ connection system. The FACT connection system consists of two vertical pins, two horizontal connection pins and alignment pads for each boom connection location.

Powered boom hinge system including cylinder, piping, operating controls and locking device standard.

Luffing jib preparation included as standard.

Optional 3,0 m (10'), 6,1 m (20'), and 12,2 m (40') No. 82 boom inserts with steel boom suspension straps, and FACT™ connection system.

Optional No. 82 or No. 22EL detachable upper boom point with one 76,2 cm (30") diameter tapered roller bearing steel sheave grooved for 26 mm or (1") rope with rope guard for liftcrane.

Optional No. 22EL basic heavy-lift boom similar to No. 82 described above, but with pinned boom connections and boom suspension pendants in lieu of FACT™ boom connection system and steel boom suspension straps.

Optional 3,0 m (10'), 6,1 m (20'), and 12,2 m (40') No. 22 boom inserts with pinned boom connections and boom suspension pendants.

Optional 12,2 m (40') No. 22C open throat top with with six 76,2 cm (30") diameter straight roller bearing sheaves on one shaft and boom suspension pendants. Used with No. 22E boom butt and inserts.

Optional 15,2 m (50') No. 22E light tapered top and 9,1 m (30') tapered insert with pinned boom connections and boom suspension pendants. Used with No. 22E boom butt and inserts.



No. 82 Long Reach Boom Top

Optional 15,2 m (50') No. 82 basic long reach boom top with four 76,2 cm (30") diameter straight roller bearing sheaves. Includes rope guides, steel boom suspension straps, and FACT™ connection system. Utilizes existing 9,1 m (30') butt and No. 82 boom inserts for lengths up to 103,6 m (340'). Requires one 12,2 m (40') light weight boom insert for lengths equal to or greater than 94,4 m (310').



No. 134 Fixed Jib

Optional No. 134 basic fixed jib 9,1 m (30') length consisting of 4,6 m (15') jib butt and 4,6 m (15') jib top with 3,7 m (12') jib strut, pendants and backstay. Includes LMI hardware. For use with booms No. 82, No. 82LR, or No. 22EL, or as a fixed jib extension on No. 149 luffing jib.

Optional No. 134 fixed jib inserts 3,0 m (10') and 6,1 m (20') with pendants.

Utilize fixed jib inserts in combination with the No. 134 basic fixed jib for total lengths up to 24,4 m (80').

Note: Jib lengths greater than 18,3 m (60') require the use of at least one 6,1 m (20') No. 134 fixed jib insert.



No. 123 Fixed Jib

Optional No. 123 basic fixed jib 9,1 m (30') length consisting of 4,6 m (15') jib butt and 4,6 m (15') jib top with 3,7 m (12') jib strut, pendants and backstay. For use with No. 82LR boom top, No. 22C open throat top or No. 22E light tapered top.

Optional No. 123 fixed jib inserts 3,0 m (10') and 6,1 m (20') with pendants.

Utilize fixed jib inserts in combination with the No. 123 basic fixed jib for total lengths up to 18,3 m (60').



No. 149 Luffing Jib

Optional 21,3 m (70') basic No. 149 luffing jib assembly with LMI hardware consisting of 7,6 m (25') butt, 6,1 m (20') insert and 7,6 m (25') top with three 68,6 cm (27") straight roller bearing sheaves and pin connected jib sections, steel boom suspension straps, fixed strut, jib strut, backstay straps, jib point wheel, 26 mm luffing jib hoist line, and FACT™ connection system. Used only with No. 82 heavy-lift boom.

model 999



specifications

6

Optional 3,0 m (10'), 6,1 m (20'), and 12,2 m (40') No. 149 inserts with steel boom suspension straps.

Optional 6,1 m (20') insert with sheaves and guides for intermediate fall that provides up to two-part load line at intermediate position in luffing jib. Use of insert may require intermediate luffing jib suspension.

Can be assembled in the air.

Note: Only one 3,0 m (10') insert is allowed in the luffing jib.



No. 135 Luffing Jib

Optional 21,3 m (70') basic No. 135 luffing jib assembly with LMI hardware consisting of 8,2 m (27') butt, 6,1 m (20') insert, and 7,0 m (23') top with two 68,6 cm (27") straight roller bearing sheaves and pin connected jib sections, pendants, fixed strut, jib strut, backstay pendants, boom point wheel, 26 mm luffing jib hoist line. For use with No. 82 or No. 22EL boom.

Optional 3,0 m (10'), 6,1 m (20'), and 12,2 m (40') No. 135 inserts with pendants. Utilize luffing jib inserts in combination with the No. 135 basic luffing jib for total lengths up to 73,2 m (240').

Optional luffing jib fold-under erection equipment includes wire rope guide and manual pin release parts to allow jib to fold under.

Note: Only one 3,0 m (10') insert is allowed in the luffing jib.

Note: 7 m (23') top, inserts, and pendants for inserts from No. 23 boom can be used as part of No. 135 luffing jib. No. 23 boom top requires modifications.



No. 138 Fixed Jib Extension

Optional 9,1 m (30') basic fixed jib extension includes jib stop, backstay, wheel, and mounting parts for use on No. 135 luffing jib.

Optional No. 138 3,0 m (10') inserts with pendants. Utilize fixed jib inserts in combination with the No. 138 basic fixed jib extension for total lengths up to 18,3 m (60').

Note: 4,6 m (15') top, 3,0 m (10') inserts, pendants for inserts, and 5,5 m (18') strut from No. 124 fixed jib can be used as part of No. 138 fixed jib extension. No. 124 jib top requires modifications.



999 MAX-ER™

Optional: 999 MAX-ER™ provides cost effective superior capacity and reach. Designed for fast assembly, the MAX-ER™ can be erected in as little as one day.

Major components of the 999 MAX-ER™ include mast and backhitch, and a suspended trailing counterweight assembly available with or without wheels.



999 RINGER®

Optional: 999 RINGER® delivers maximum capacity and outlifts competitive equipment at the most-used working radii.

Modular components sized for easy transportation by truck simplify shipment and minimize the number of transport loads.

Modular design and FACT™ connection technology cut assembly time to three days or less.

The 999 RINGER® consists of:

RINGER® Side Beams: High-strength beams connect ring to basic crane. FACT™ connectors simplify set-up. Beams provide mounting for four hydraulic jacks that level the ring during set-up.

Ring: Four-section ring with FACT™ connectors is easy to transport and assemble. Ring's 13,7 m (45') diameter provides stability, yet fits into tight areas and requires minimal site preparation. Ring distributes loadings to the support pedestals. Side sections can be removed and installed quickly to reduce width for on-site travel.

Ring Support Pedestals: Thirty-four pedestals, each covering 1,9 m² (3,000 in²), distribute loadings to minimize ground-bearing pressure. Each pedestal's elevation can be adjusted to compensate for uneven surfaces.

Boom Carrier: Wide, high-strength weldment supports boom, mast, two swing drives, main hoist, power plant, and optional auxiliary hoist. Carrier's width and equalized rollers distribute loadings over large area of ring to provide stability and minimize ground bearing pressure. FACT™ connectors permit fast installation.

Mast: Self-erecting 36,6 m (120') stationary mast is raised into place by the 999's boom hoist and is connected to the counterweight carrier by steel backhitch straps. Mast height permits raising of boom-and-jib combinations more than 182,9 m (600') long. Stationary design provides superior boom control.

model 999



Boom: 600 metric ton (661.4 ton) capacity. Lengths from 38,1 m (125') to 129,5 m (425'). Boom top accepts upper point, fixed jib, and luffing jib. Boom-support and backhitch straps stow atop corresponding sections of boom and mast.

Swing Drive: Four RINGER-SWINGER® hydraulic drives provide smooth, controlled swing to left or right, with free float when control lever is in neutral. Mounted to boom carrier and counterweight carrier, RINGER SWINGERS engage gear segments mounted to ring. System provides optimum distribution of torque and maximum control

Auxiliary Power Plant: 246 kW (330 hp) diesel engine mounted to boom carrier works with basic crane's engine to power all functions. Efficient closed-loop hydraulics deliver maximum power and permit independent operation of each function.

Front Hoist: Hydraulically powered drum mounted on boom hoist carrier raises and lowers main load block. Spooling capacity permits full-range block travel with maximum loads. Redundant drives can *each* provide maximum required drum torque. Grooved laggings promote proper spooling and maximize rope life.

Rear Hoist: Optional hoist mounted behind main hoist on boom carrier is used for whipline on boom or as positioning hoist for luffing jib. Grooved laggings promote proper spooling and maximize rope life.

Auxiliary Hoist: Optional hoist mounted in boom butt provides high-speed hoisting of light loads and fast rigging of large loads. Grooved laggings promote proper spooling and maximize rope life. Also used as load hoist for luffing jib.

NOTE: All hoists are equipped with ratcheting pawl motion locks.

Counterweight Carrier: High-strength platform supports counterweight and provides mounting for two swing drives. FACT™ connectors simplify installation. Carrier's width and equalized rollers distribute loadings over a large area of the ring.

Counterweight: Solid steel boxes stack and interlock on counterweight carrier. Boxes are sized and weighted for easy shipment.

Operator's Cab: Operator's cab from 999 crane is mounted on a pedestal to position operator for visibility. Control functions are changed from liftcrane to RINGER® mode electronically in the EPIC® microprocessor, eliminating repiping. EPIC® system provides precise control and monitors all functions.

RINGER® Options:

Counterweight-removal system
Detachable upper boom point

Stationary jib
Luffing jib
Load-moment indicator
Load blocks

Optional Equipment

Optional Blocks and Hooks –

13,6 mton (15 ton) swivel hook and weight ball.

41 mton (45 ton) hook block with one 76,2 cm (30") sheave for 26 mm or (1") wire rope with swivel hook, hook latch, and swivel lock (assembly block).

54 mton (60 ton) hook block with two 76,2 cm (30") sheaves for 26 mm or (1") wire rope with swivel hook, hook latch, and swivel lock.

91 mton (100 ton) hook block with three 76,2 cm (30") sheaves for 26 mm or (1") wire rope with swivel hook, hook latch, and swivel lock.

181,4 mton (200 ton) hook block with six 76,2 cm (30") sheaves for 26 mm or (1") wire rope with swivel hook, hook latch, and swivel lock

Upper block single sheave to be added to 181,4 mton (200 ton) load block for upgrade to 208,6 mton (230 ton) capacity

200 mton (220 ton) hook block with seven 76,2 cm (30") sheaves for 26 mm or (1") wire rope with swivel hook, hook latch, and swivel lock

227 mton (250 ton) hook block with eight 76,2 cm (30") sheaves for 26 mm or (1") wire rope with swivel hook, hook latch, and swivel lock.

Optional Hydraulic Test Kit: required to properly analyze the performance of the EPIC® control system.

Optional Service Interval Kits: for the regularly scheduled maintenance of general crane operations.

Optional Lighting Packages: consult Factory for available options.

Optional Special Paint: in color(s) other than Manitowoc standard red and black.

Optional Special Customer Decals: custom vinyl decal(s) of name and/or logo from artwork supplied by customer.

Optional Export Packaging: basic crane, boom and jib sections.

specifications

8

Optional Applications

Options for limited clamshell work: guide bars for lower boom point; Rud-O-Matic® No. 1866 spring-powered three-barrel tagline with 76,2 cm (36") diameter wheel; and pressure rollers for the front and rear hoisting drums. Front drum is closing line. Rear drum is holding line. Manitowoc's EPIC® controls can be changed from liftcrane to clamshell mode with the flip of a switch.

On units equipped with the (pin-connected, pendant-supported) 22EL boom, it is also possible to replace the "L" boom top with the open-throat top for improved performance in clamshell operation. The open throat top may **not** be mounted to the (FACT™ connected, strap-supported) No. 82 boom.

Options for dedicated clamshell work. Manitowoc recommends: the open throat top, the detachable upper boom point with two 91,4 cm (36") diameter roller-bearing-mounted sheaves and cheek plates, pressure rollers on the front and rear drums, and the Rud-O-Matic® No. 1866 spring-powered three-barrel tagline with 76,2 cm (30") diameter wheel. Freefall hoisting drums are also recommended. Front drum is closing line. Rear drum is holding line.

Options for limited dragline work. Manitowoc recommends these options: Guide bars for lower boom point; pressure rollers for the front and rear hoisting drums, freefall drums, and fairlead with dirt guard. Front drum is drag line. Rear drum is hoist line. Manitowoc's EPIC® controls can be changed from liftcrane to dragline mode with the flip of a switch.

On units equipped with the (pin-connected, pendant-supported) 22EL boom, it is also possible to replace the "L" boom top with the open-throat top for improved performance in dragline operation. The open throat top may not be mounted to the (FACT™-connected, strap-supported) No. 82 boom.

model 999



outline dimensions

9

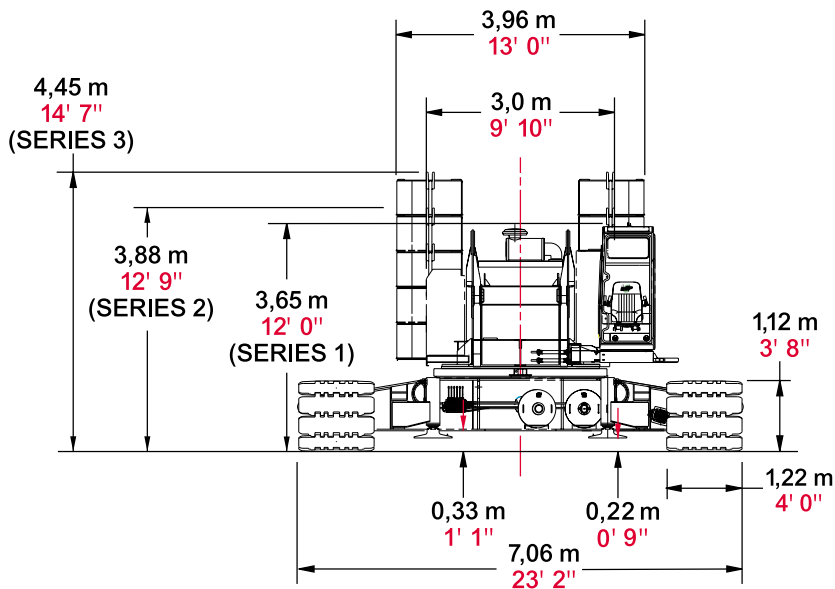
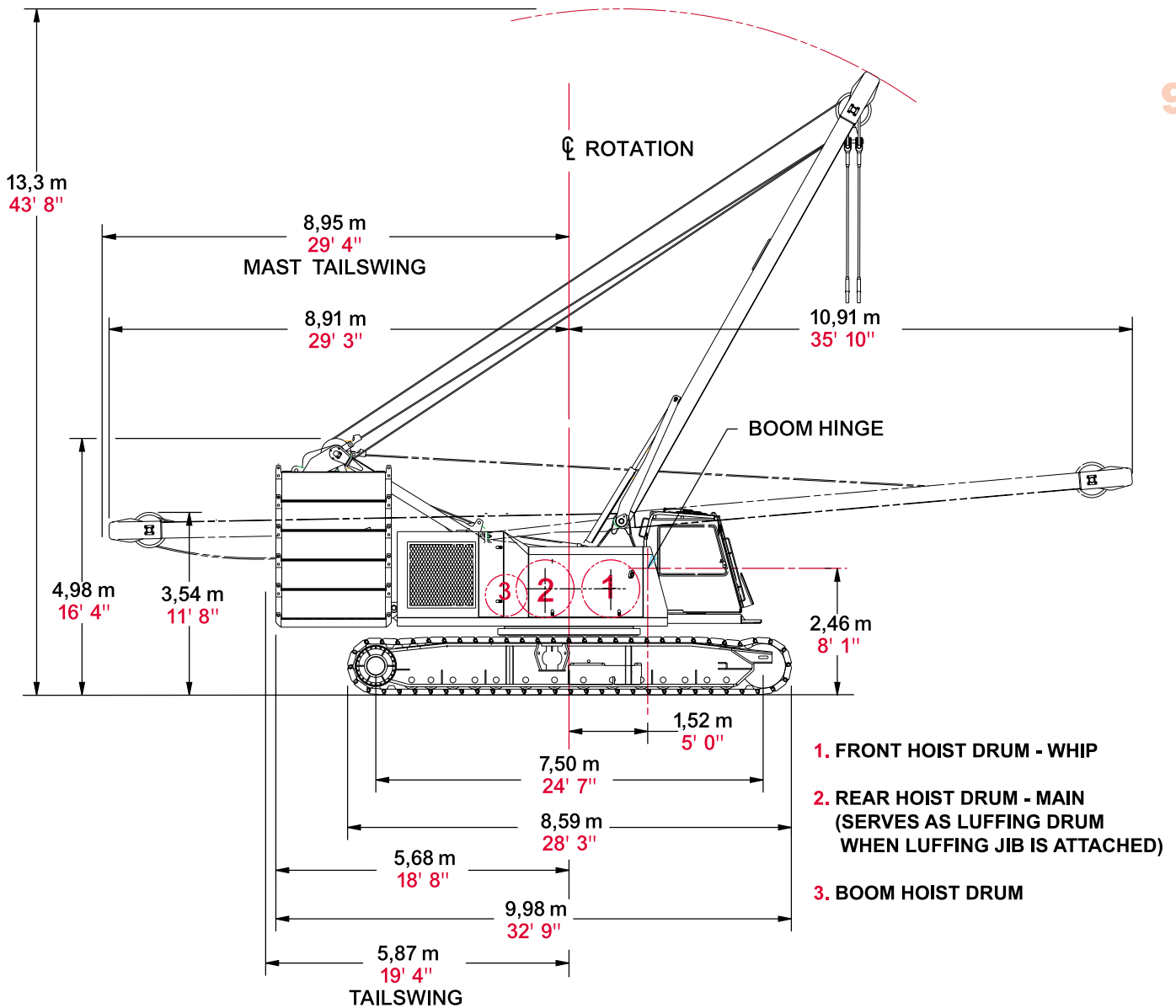

outline dimensions

10

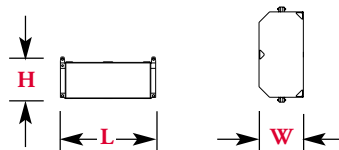
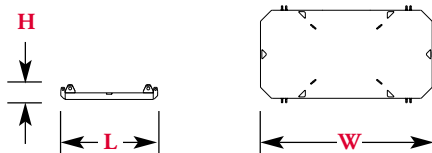
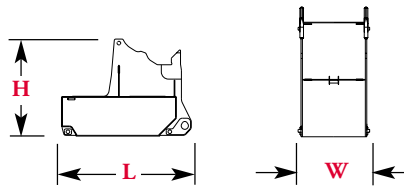
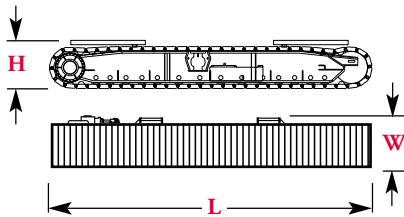
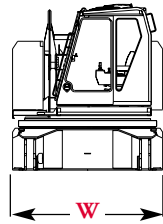
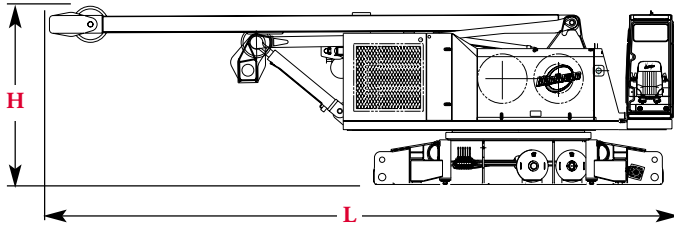

Basic Crane x 1

Length	11,87 m	38' 11"
Width	3,00 m	9' 10"
Height	3,38 m	11' 1"
Weight	39 689 kg	87,500 lb

Note: Weight includes carbody, upperworks, operator's cab, gantry, backhitch, mast, boom-hoist wire rope, maximum hoist and whip lines on drums, optional self-assembly jacks, full hydraulic fluid reservoir, and half tank of fuel.

Crawlers with Catwalks x 2

Length	8,59 m	28' 3"
Width	1,48 m	4' 10"
Height	1,30 m	4' 3"
Weight	19 622 kg	43,260 lb

Upper Center Counterweight x 1

Length	2,31 m	7' 7"
Width	1,27 m	4' 2"
Height	1,71 m	5' 7"
Weight	10 659 kg	23,500 lb

Counterweight Tray x 1

Length	2,24 m	7' 4"
Width	3,96 m	13' 0"
Height	0,34 m	1' 2"
Weight	9 548 kg	21,050 lb

Upper Side Counterweight Standard Profile

Series 1	x 6
Series 2	x 8
Series 3	x 10

Length	2,24 m	7' 4"
Width	1,07 m	3' 6"
Height	0,69 m	2' 3"
Weight	7 938 kg	17,500 lb

outline dimensions

11

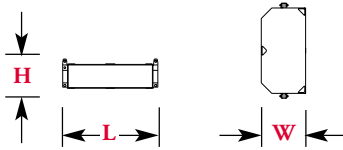

Upper Side Counterweight Optional Low Profile Series 3 Only x 12		
Length	2,24 m	7' 4"
Width	1,07 m	3' 6"
Height	0,48 m	1' 7"
Weight	6 611 kg	14,485 lb

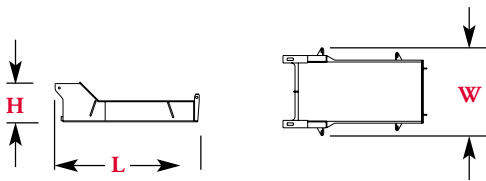

Lower Carbody Counterweight Series 2, 3 x 2		
Length	2,97 m	9' 9"
Width	1,80 m	5' 11"
Height	0,82 m	2' 8"
Weight	9 979 kg	22,000 lb

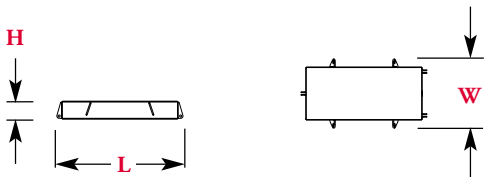

Upper Carbody Counterweight Series 3 x 2		
Length	2,74 m	9' 0"
Width	1,50 m	4' 11"
Height	0,39 m	1' 4"
Weight	8 165 kg	18,000 lb

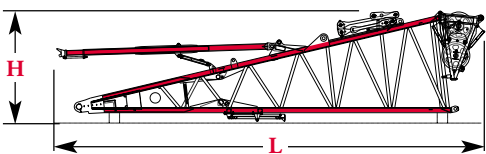

No. 82 Boom Butt 9,1 m (30') & Wire Rope Guide, Boom Stop x 1		
Length	10,49 m	34' 5"
Width	2,41 m	7' 11"
Height	2,71 m	8' 11"
Weight	4 910 kg	10,825 lb

Note: Includes boom butt support for self-erect option, boom angle indicator, and cable reel.

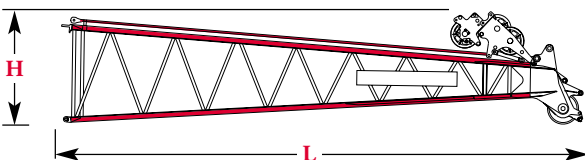

No. 82 Boom Top 12,2 m (40') & Wire Rope Guide, Straps x 1		
Length	12,75 m	41' 10"
Width	2,41 m	7' 11"
Height	2,82 m	9' 3"
Weight	5 609 kg	12,365 lb

Option

outline dimensions

12

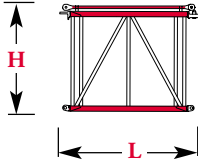

No. 82 Main Boom 3,0 m (10')		
Insert & Straps		x 1, 2
Length	3,20 m	10' 6"
Width	2,41 m	7' 11"
Height	2,59 m	8' 6"
Weight	971 kg	2,140 lb

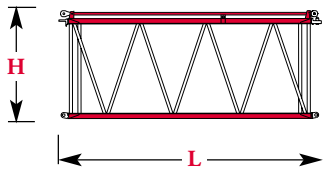

No. 82 Main Boom 6,1 m (20')		
Insert & Straps		x 1, 2
Length	6,25 m	20' 6"
Width	2,41 m	7' 11"
Height	2,54 m	8' 4"
Weight	1 397 kg	3,080 lb

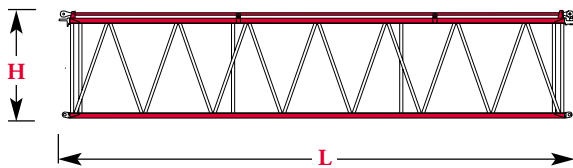

No. 82 Main Boom 12,2 m (40')		
Insert & Straps		x 1, 2, 3, 4, 5
Length	12,34 m	40' 6"
Width	2,41 m	7' 11"
Height	2,54 m	8' 4"
Weight	2 431 kg	5,360 lb

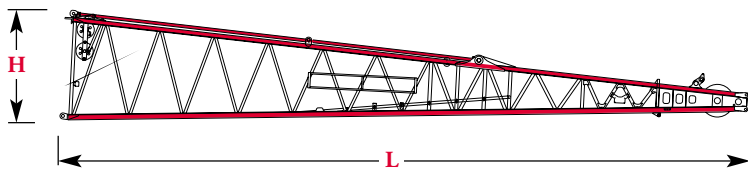

No. 82 Long Reach Boom Top 15,2 m (50') & Wire Rope Guide, Straps		
		x 1
Length	16,02 m	52' 7"
Width	2,41 m	7' 11"
Height	2,54 m	8' 4"
Weight	3 216 kg	7,090 lb

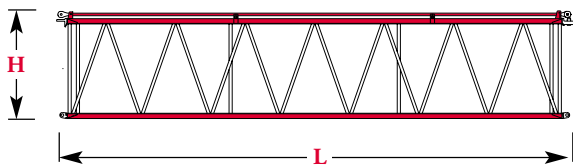

No. 82 Long Reach Boom Light Weight 12,2 m (40') Insert & Straps		
		x 1
Length	12,34 m	40' 6"
Width	2,41 m	7' 11"
Height	2,54 m	8' 4"
Weight	2 137 kg	4,715 lb

Option

model 999



outline dimensions

13

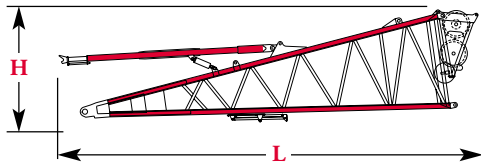

No. 22E Boom Butt 9,1 m (30') & Wire Rope Guide, Boom Stop x 1

Length	10,49 m	34' 5"
Width	2,41 m	7' 11"
Height	2,71 m	8' 11"
Weight	4 791 kg	10,570 lb

Note: Includes boom butt support for self-erect option, boom angle indicator, and cable reel.

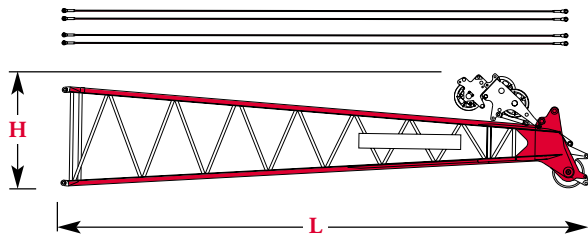

No. 22L Boom Top 12,2 m (40') & Wire Rope Guide, Pendants x 1

Length	12,75 m	41' 10"
Width	2,41 m	7' 11"
Height	2,82 m	9' 3"
Weight	5 255 kg	11,585 lb

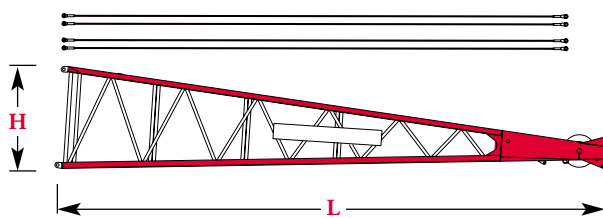

No. 22C Boom Top 12,2 m (40') & Wire Rope Guide, Pendants x 1

Length	12,89 m	42' 4"
Width	2,41 m	7' 11"
Height	2,41 m	7' 11"
Weight	4 437 kg	9,780 lb

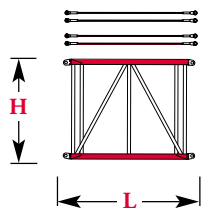

No. 22E Main Boom 3,0 m (10') Insert & Pendants x 1, 2

Length	3,18 m	10' 5"
Width	2,41 m	7' 11"
Height	2,57 m	8' 5"
Weight	874 kg	1,935 lb

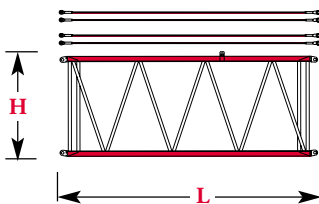

No. 22E Main Boom 6,1 m (20') Insert & Pendants x 1, 2

Length	6,22 m	20' 5"
Width	2,41 m	7' 11"
Height	2,57 m	8' 5"
Weight	1 416 kg	3,130 lb

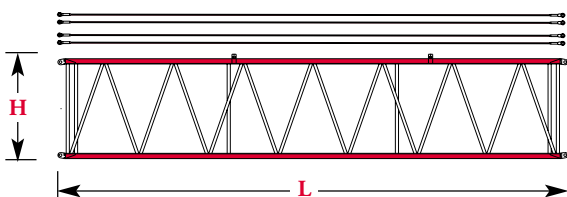

No. 22E Main Boom 12,2 m (40') Insert & Pendants x 1, 2, 3, 4, 5

Length	12,32 m	40' 5"
Width	2,41 m	7' 11"
Height	2,57 m	8' 5"
Weight	2 404 kg	5,300 lb

Option

outline dimensions

14

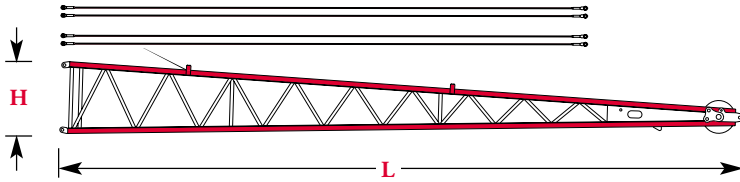

No. 22E Light Tapered Top		
15,2 m (50') & Pendants	x 1	
Length	15,90 m	52' 2"
Width	1,91 m	6' 3"
Height	1,67 m	5' 6"
Weight	2 967 kg	6,540 lb

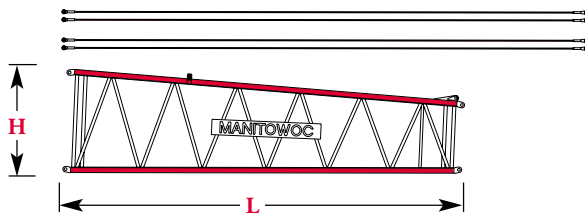

No. 22E Light Tapered Top		
9,1 m (30') Tapered Insert	x 1	
Length	9,27 m	30' 5"
Width	2,41 m	7' 11"
Height	2,41 m	7' 11"
Weight	1 855 kg	4,090 lb

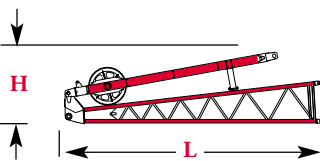

No. 134 Jib Butt 4,6 m (15')		
& Strut, Stop	x 1	
Length	4,67 m	15' 4"
Width	0,86 m	2' 10"
Height	1,29 m	4' 3"
Weight	635 kg	1,400 lb

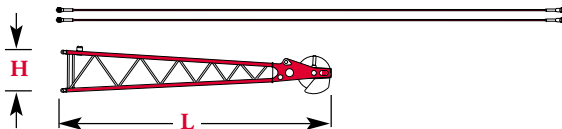

No. 134 Jib Top 4,6 m (15')		
& Pendants	x 1	
Length	4,93 m	16' 2"
Width	0,79 m	2' 7"
Height	0,79 m	2' 7"
Weight	553 kg	1,220 lb

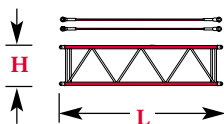

No. 134 Jib Insert 3,0 m (10')		
& Pendants	x 1	
Length	3,20 m	10' 6"
Width	0,79 m	2' 7"
Height	0,79 m	2' 7"
Weight	218 kg	480 lb

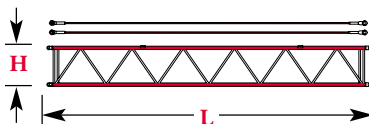

No. 134 Jib Insert 6,1 m (20')		
& Pendants	x 1, 2	
Length	6,17 m	20' 3"
Width	0,79 m	2' 7"
Height	0,79 m	2' 7"
Weight	340 kg	750 lb

Option

outline dimensions

15

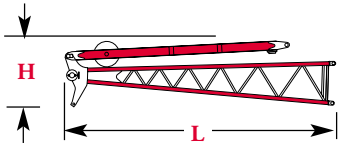

No. 123 Jib Butt 4,6 m (15') & Strut	x 1	
Length	4,75 m	15' 7"
Width	0,86 m	2' 10"
Height	1,16 m	3' 10"
Weight	460 kg	1,015 lb

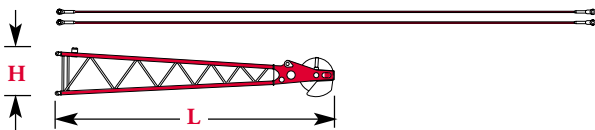

No. 123 Jib Top 4,6 m (15') & Pendants	x 1	
Length	4,93 m	16' 2"
Width	0,79 m	2' 7"
Height	0,79 m	2' 7"
Weight	422 kg	930 lb

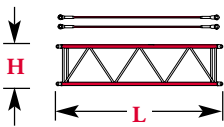

No. 123 Jib Insert 3,0 m (10') & Pendants	x 1, 2, 3	
Length	3,12 m	10' 3"
Width	0,79 m	2' 7"
Height	0,79 m	2' 7"
Weight	217 kg	480 lb

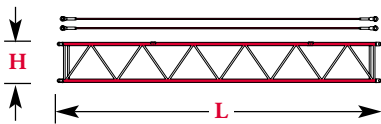

No. 123 Jib Insert 6,1 m (20') & Pendants	x 1	
Length	6,17 m	20' 3"
Width	0,79 m	2' 7"
Height	0,79 m	2' 7"
Weight	341 kg	750 lb

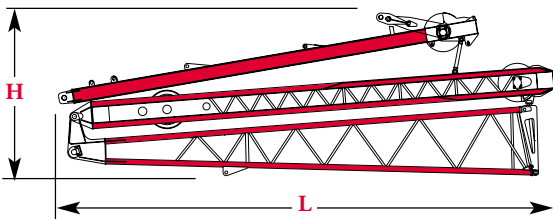

No. 135 Luffing Jib 8,2 m (27') Butt & Struts	x 1	
Length	8,81 m	28' 11"
Width	1,57 m	5' 2"
Height	2,92 m	9' 7"
Weight	4 477 kg	9,870 lb

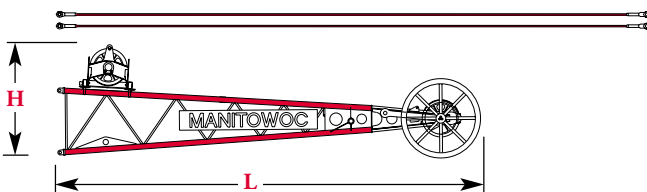

No. 135 Luffing Jib Top 7,0 m (23') & Roller, Pendants	x 1	
Length	7,80 m	25' 7"
Width	1,52 m	5' 0"
Height	2,02 m	6' 8"
Weight	1 984 kg	4,375 lb

Note: Includes wire rope guide.

Option

outline dimensions

16

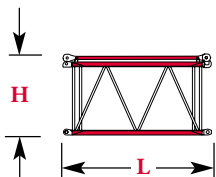
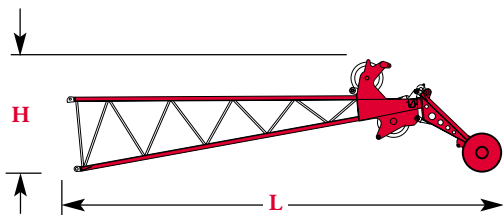
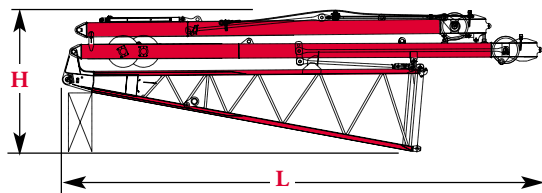
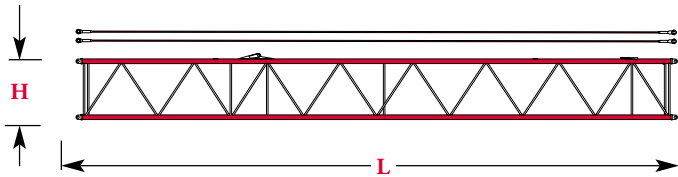
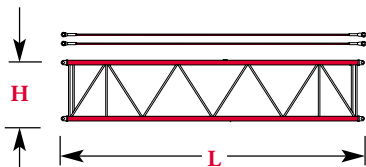
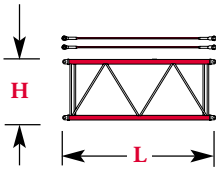

No. 135 Luffing Jib Insert		
3,0 m (10') & Pendants x 1		
Length	3,15 m	10' 4"
Width	1,52 m	5' 0"
Height	1,30 m	4' 3"
Weight	381 kg	840 lb

No. 135 Luffing Jib Insert		
6,1 m (20') & Pendants x 1, 2		
Length	6,20 m	20' 4"
Width	1,52 m	5' 0"
Height	1,30 m	4' 3"
Weight	612 kg	1,350 lb

No. 135 Luffing Jib Insert		
12,2 m (40') & Pendants x 1, 2, 3		
Length	12,29 m	40' 4"
Width	1,52 m	5' 0"
Height	1,30 m	4' 3"
Weight	1 050 kg	2,315 lb

PRELIMINARY

No. 149 Luffing Jib 7,6 m (25')		
Butt & Struts x 1		
Length	10,41 m	34' 2"
Width	2,08 m	6' 10"
Height	3,10 m	10' 2"
Weight	6 350 kg	14,000 lb

PRELIMINARY

No. 149 Luffing Jib Top		
7,6 m (25') & Roller, Straps x 1		
Length	10,24 m	33' 7"
Width	2,08 m	6' 10"
Height	2,49 m	8' 2"
Weight	2 586 kg	5,700 lb

Note: Includes wire rope guide, roller and sheave for upper boom point.

PRELIMINARY

No. 149 Luffing Jib Insert		
3,0 m (10') & Straps x 1		
Length	3,23 m	10' 7"
Width	2,08 m	6' 10"
Height	1,91 m	6' 3"
Weight	590 kg	1,300 lb

Option

outline dimensions

17

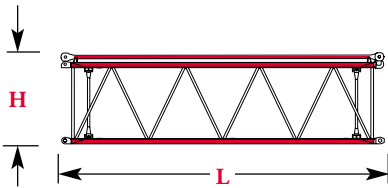

PRELIMINARY

No. 149 Luffing Jib Insert
6,1 m (20') & Straps x 1, 2

Length	6,27 m	20' 7"
Width	2,08 m	6' 10"
Height	1,91 m	6' 3"
Weight	975 kg	2,150 lb

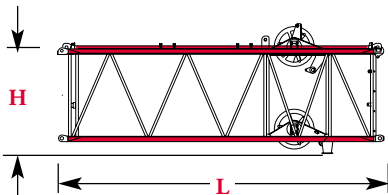

PRELIMINARY

No. 149 Luffing Jib Insert
INTERMEDIATE FALL
6,1 m (20') & Straps x 1

Length	6,27 m	20' 7"
Width	2,08 m	6' 10"
Height	2,49 m	8' 2"
Weight	2 041 kg	4,500 lb

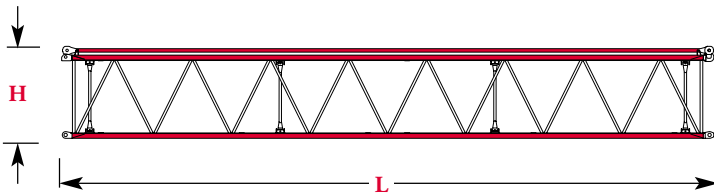

PRELIMINARY

No. 149 Luffing Jib Insert
12,2 m (40') & Straps x 1, 2, 3, 4

Length	12,37 m	40' 7"
Width	2,08 m	6' 10"
Height	1,91 m	6' 3"
Weight	1 724 kg	3,800 lb

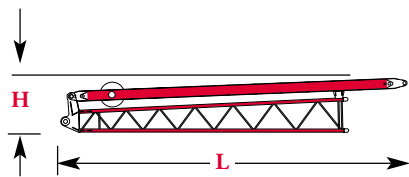

PRELIMINARY

No. 138 Fixed Jib 4,6 m (15')
Butt & Strut x 1

Length	5,64 m	18' 6"
Width	2,08 m	6' 10"
Height	1,91 m	6' 3"
Weight	350 kg	775 lb

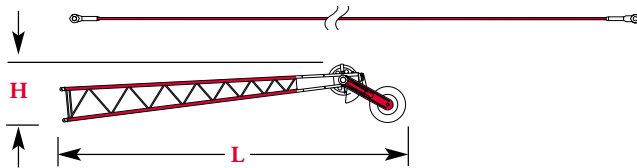

PRELIMINARY

No. 138 Fixed Jib 4,6 m (15')
Top & Roller, Pendant x 1

Length	5,51 m	18' 1"
Width	0,76 m	2' 6"
Height	1,05 m	3' 5"
Weight	370 kg	817 lb

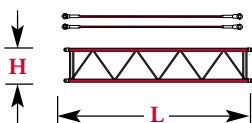

PRELIMINARY

No. 138 Jib Insert 3,0 m (10')
& Pendants x 1, 2, 3

Length	3,12 m	10' 3"
Width	0,76 m	2' 6"
Height	0,58 m	1' 11"
Weight	98 kg	215 lb

Option

model 999



outline dimensions

18

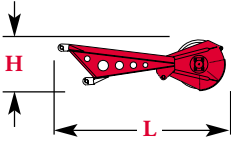

No. 82 or No. 22EL Upper Boom Point x 1		
Length	2,64 m	8' 8"
Width	0,41 m	1' 4"
Height	0,81 m	2' 8"
Weight	420 kg	925 lb

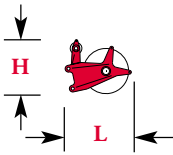

No. 82 Long Reach Boom top Upper Boom Point x 1		
Length	1,09 m	3' 7"
Width	0,37 m	1' 3"
Height	1,01 m	3' 4"
Weight	157 kg	345 lb

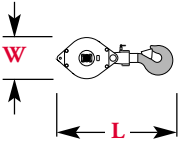

Hook block for 26 mm or (1") wire rope					
Capacity	227 mt	250 t	Length	2,39 m	7' 10"
Weight	2 744 kg	6,050 lb	Width	0,94 m	3' 1"
Capacity*	200 mt	220 t	Length	2,28 m	7' 5"
Weight	3 026 kg	6,670 lb	Width	0,89 m	2' 11"
Capacity	182 mt	200 t	Length	2,28 m	7' 5"
Weight	2 540 kg	5,600 lb	Width	0,89 m	2' 11"
Capacity	91 mt	100 t	Length	1,98 m	6' 6"
Weight	1 769 kg	3,900 lb	Width	0,89 m	2' 11"
Capacity	55 mt	60 t	Length	1,80 m	5' 11"
Weight	1 202 kg	2,650 lb	Width	0,89 m	2' 11"

*Single sheave upper block can be added for 208,6 mton (230 ton) capacity.

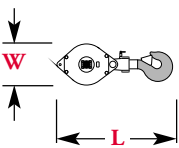

Self Assembly Hook block for 26 mm or (1") wire rope					
Capacity	41 mt	45 t	Length	1,83 m	6' 0"
Weight	1 179 kg	2,600 lb	Width	0,91 m	3' 0"

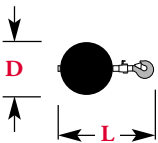

Weight Ball					
Capacity/Swivel	13,6 mt	15 t	Diameter	0,56 m	1' 10"
Weight	594 kg	1 310 lb	Length	1,07 m	3' 6"

Option

transport data

19

Trailer Load Out Summary

Model 999 Series 3
No. 134 Fixed Jib 24,4 m (80') and
No. 82 Boom 91,4 m (300')

Item	Weight each Item kg (lb)	Quantity on Trailer Load #											
		1	2	3	4*	5	6	7	8	9	10	11	12
No. 999 Basic Crane	39 689 (87,500)	1											
Crawler Assembly	19 622 (43,260)		1	1									
Counterweight Tray	9 548 (21,050)						1						
Upper Center Counterweight	10 659 (23,500)						1						
Upper Side Counterweight	7 938 (17,500)				2	2		2	2	2			
Lower Carbody Counterweight	9 979 (22,000)									1	1		
Upper Carbody Counterweight	8 165 (18,000)												2
9,1 m (30') No. 82 Boom Butt**	4 910 (10,825)				1								
12,2 m (40') No. 82 Boom Top	5 609 (12,365)					1							
3,0 m (10') No. 82 Boom Insert	971 (2,140)												1
6,1 m (20') No. 82 Boom Insert	1 397 (3,080)												1
12,2 m (40') No. 82 Boom Insert***	2 431 (5,360)							1	1	1	1	1***	
10,0 m (30') No. 134 Jib & Strut	1 188 (2,620)		1										
3,0 m (10') No. 134 Jib Insert	218 (480)		1										
6,1 m (20') No. 134 Jib Insert	340 (750)			2									
227 mton (250 ton) Hook Block	2 744 (6,050)									1			
41 mton (45 ton) Self-assembly Block	1 179 (2,600)			1									
13,6 mton (15 ton) Weight Ball	594 (1,310)											1	
No. 82 Upper Boom Point	420 (925)											1	
Miscellaneous	1 814 (4,000)									1	1		
Approximate Total Shipping Weight kg (lb)		39 689 (87,500)	21 028 (46,360)	21 481 (47,360)	20 786 (45,825)	21 485 (47,365)	20 207 (44,550)	18 307 (40,360)	18 307 (40,360)	18 307 (40,360)	16 968 (37,410)	15 238 (33,595)	18 698 (41,220)

* Step deck trailer recommended.

** Does not include auxiliary drum.

*** One insert includes jib backstay lugs.

transport data

20

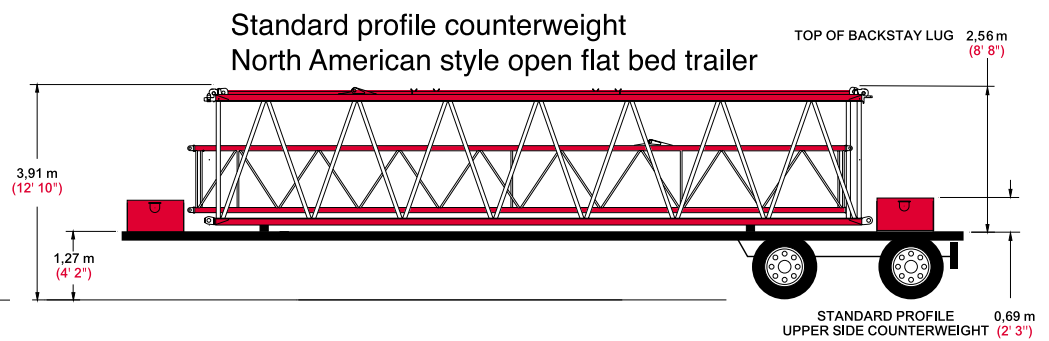
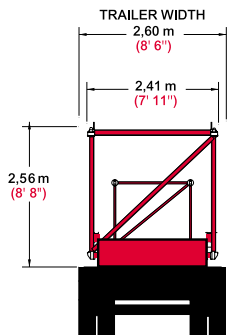
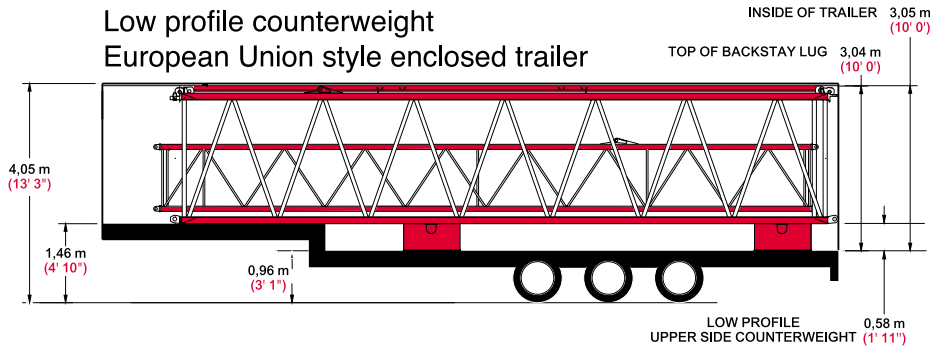
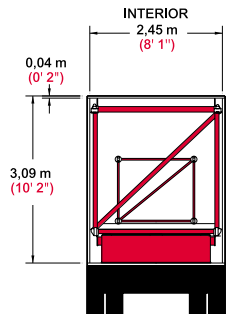
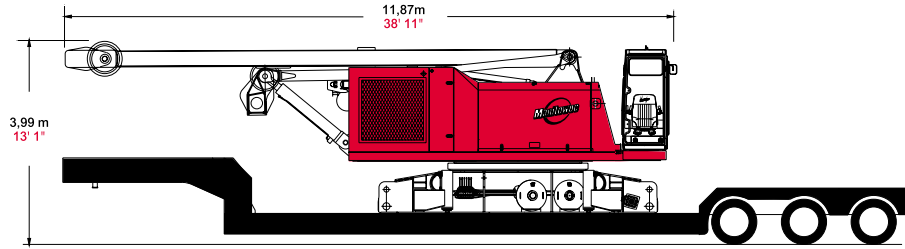
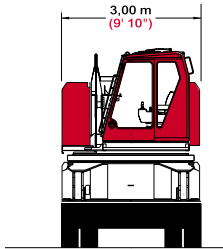

crane assembly

21

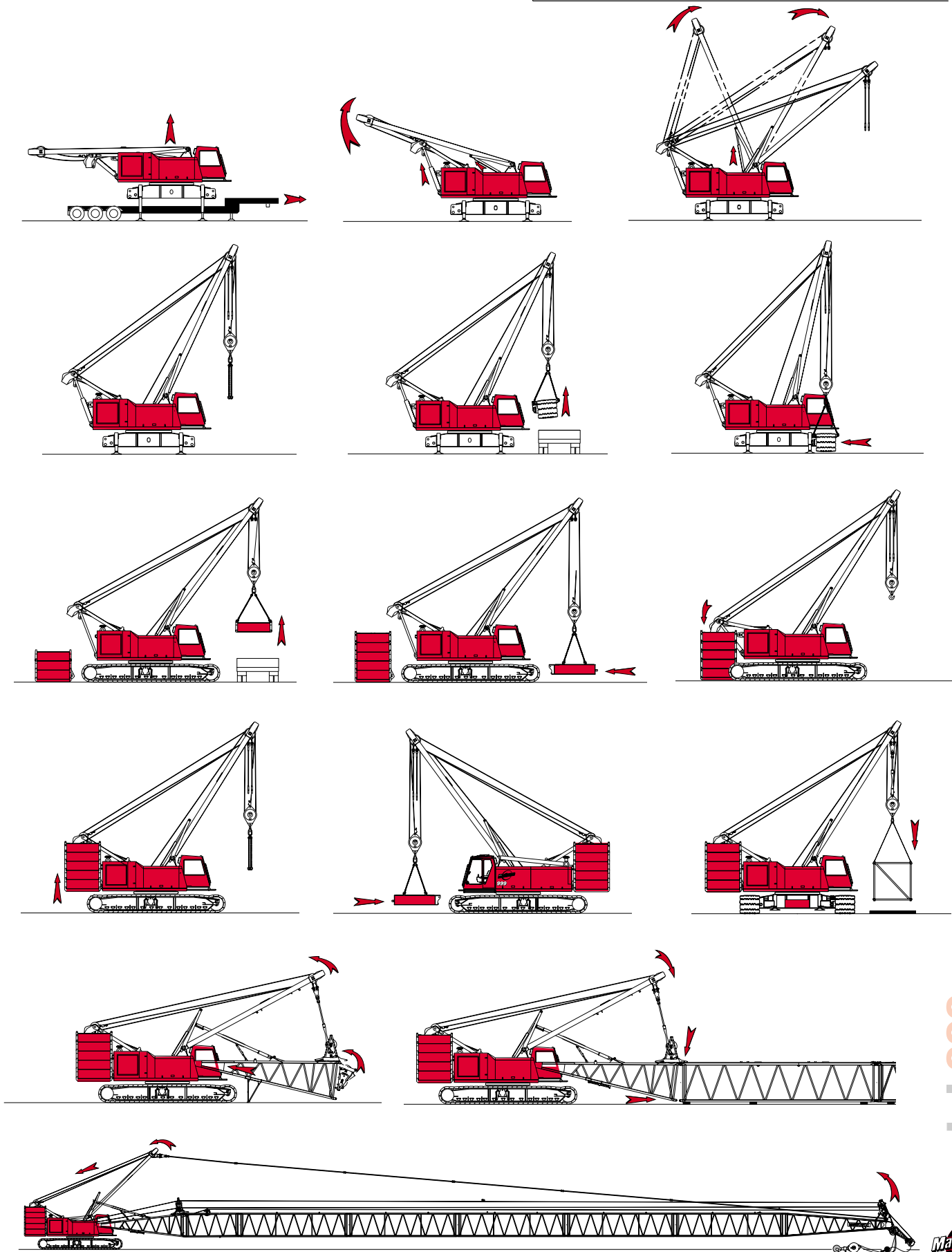

Note: Read the assembly folio in the operator's manual for a complete description of approved crane assembly procedures.

performance data

22

Wire Rope Lengths
Boom No. 82 or No. 22EL
 - or -
Fixed Jib No. 134 on
Boom No. 82 or No. 22EL

Boom or Boom and Fixed Jib Length	Whip Line				Hoist line		
	Front or Aux Drum (1 Part of Line)		Front or Aux Drum (2 Parts of Line)		Rear Drum	Maximum Required Parts of Line	
	m	(ft)	m	(ft)	m		(ft)
21,3 (70)	55	(180)	82	(270)	404	(1,325)	16
24,4 (80)	61	(200)	91	(300)	457	(1,500)	16
27,4 (90)	67	(220)	101	(330)	457	(1,500)	14
30,5 (100)	73	(240)	110	(360)	495	(1,625)	14
33,5 (110)	79	(260)	119	(390)	495	(1,625)	12
36,6 (120)	85	(280)	128	(420)	495	(1,625)	11
39,6 (130)	91	(300)	137	(450)	495	(1,625)	10
42,7 (140)	98	(320)	146	(480)	495	(1,625)	10
45,7 (150)	104	(340)	152	(500)	495	(1,625)	9
48,8 (160)	110	(360)	162	(530)	495	(1,625)	8
51,8 (170)	116	(380)	171	(560)	495	(1,625)	8
54,9 (180)	122	(400)	180	(590)	495	(1,625)	7
57,9 (190)	128	(420)	189	(620)	495	(1,625)	7
61,0 (200)	134	(440)	198	(650)	495	(1,625)	6
64,0 (210)	140	(460)	207	(680)	495	(1,625)	6
67,1 (220)	146	(480)	216	(710)	495	(1,625)	6
70,1 (230)	152	(500)	226	(740)	495	(1,625)	5
73,2 (240)	158	(520)	235	(770)	495	(1,625)	5
76,2 (250)	165	(540)	244	(800)	495	(1,625)	4
79,2 (260)	171	(560)	253	(830)	495	(1,625)	4
82,3 (270)	177	(580)	262	(860)	495	(1,625)	4
85,3 (280)	183	(600)	271	(890)	495	(1,625)	3
88,4 (290)	189	(620)	280	(920)	495	(1,625)	3
91,4 (300)	195	(640)	290	(950)	-	-	-
94,5 (310)	201	(660)	299	(980)	-	-	-
97,5 (320)	207	(680)	308	(1,010)	-	-	-
100,6 (330)	213	(700)	-	-	-	-	-

NOTE: Line lengths given in table will allow hook to touch ground. When block travel below ground is required, add additional rope equal to parts of line times added travel distance. Hoisting distance or line pull may be limited when block travel below ground is required.

Front and rear drums each provide 131 kN (29,500 lb) maximum single line pull.
 Auxiliary drum provides 89 kN (20,000 lb) maximum single line pull.

model 999



PRELIMINARY

Wire Rope Lengths Luffing Jib No. 149 on Boom No. 82

Boom and Luffing Jib Length	Luffing Jib Hoist Line					
	Front Drum		Maximum Required Parts of Line	Auxiliary Drum		Maximum Required Parts of Line
	m	(ft)		m	(ft)	
42,7 (140)	229	(750)	4	229	(750)	4
45,7 (150)	244	(800)	4	244	(800)	4
48,8 (160)	259	(850)	4	259	(850)	4
51,8 (170)	274	(900)	4	274	(900)	4
54,9 (180)	290	(950)	4	290	(950)	4
57,9 (190)	305	(1,000)	4	305	(1,000)	4
61,0 (200)	320	(1,050)	4	320	(1,050)	4
64,0 (210)	335	(1,100)	4	335	(1,100)	4
67,1 (220)	351	(1,150)	4	351	(1,150)	4
70,1 (230)	336	(1,200)	4	336	(1,200)	4
73,2 (240)	381	(1,250)	4	381	(1,250)	4
76,2 (250)	381	(1,250)	3	396	(1,300)	4
79,2 (260)	381	(1,250)	3	411	(1,350)	4
82,3 (270)	381	(1,250)	3	427	(1,400)	4
85,3 (280)	381	(1,250)	3	442	(1,450)	4
88,4 (290)	381	(1,250)	3	457	(1,500)	4
91,4 (300)	381	(1,250)	2	457	(1,500)	3
94,5 (310)	381	(1,250)	2	457	(1,500)	3
97,5 (320)	381	(1,250)	2	457	(1,500)	3
100,6 (330)	381	(1,250)	2	457	(1,500)	3
103,6 (340)	381	(1,250)	2	457	(1,500)	3
106,7 (350)	381	(1,250)	2	457	(1,500)	2
109,7 (360)	381	(1,250)	2	457	(1,500)	2
112,8 (370)	381	(1,250)	2	457	(1,500)	2

NOTE: Line lengths given in table will allow hook to touch ground. When block travel below ground is required, add additional rope equal to parts of line times added travel distance. Hoisting distance or line pull may be limited when block travel below ground is required.

Front and rear drums each provide 131 kN (29,500 lb) maximum single line pull.
Auxiliary drum provides 89 kN (20,000 lb) maximum single line pull.

performance data

24

Wire Rope Lengths Luffing Jib No. 135 on Boom No. 82 or No. 22EL

Boom and Luffing Jib Length	Luffing Jib Hoist Line					
	Front Drum		Maximum Required Parts of Line	Auxiliary Drum		Maximum Required Parts of Line
	m	(ft)		m	(ft)	
42,7 (140)	229	(750)	4	229	(750)	4
45,7 (150)	244	(800)	4	244	(800)	4
48,8 (160)	259	(850)	4	259	(850)	4
51,8 (170)	274	(900)	4	274	(900)	4
54,9 (180)	290	(950)	4	290	(950)	4
57,9 (190)	305	(1,000)	4	305	(1,000)	4
61,0 (200)	320	(1,050)	4	320	(1,050)	4
64,0 (210)	335	(1,100)	4	335	(1,100)	4
67,1 (220)	351	(1,150)	4	351	(1,150)	4
70,1 (230)	336	(1,200)	4	336	(1,200)	4
73,2 (240)	381	(1,250)	4	381	(1,250)	4
76,2 (250)	381	(1,250)	3	396	(1,300)	4
79,2 (260)	381	(1,250)	3	411	(1,350)	4
82,3 (270)	381	(1,250)	3	427	(1,400)	4
85,3 (280)	381	(1,250)	3	442	(1,450)	4
88,4 (290)	381	(1,250)	3	457	(1,500)	4
91,4 (300)	381	(1,250)	2	457	(1,500)	3
94,5 (310)	381	(1,250)	2	457	(1,500)	3
97,5 (320)	381	(1,250)	2	457	(1,500)	3
100,6 (330)	381	(1,250)	2	457	(1,500)	3
103,6 (340)	381	(1,250)	2	457	(1,500)	3
106,7 (350)	381	(1,250)	2	457	(1,500)	2
109,7 (360)	381	(1,250)	2	457	(1,500)	2
112,8 (370)	381	(1,250)	2	457	(1,500)	2

NOTE: Line lengths given in table will allow hook to touch ground. When block travel below ground is required, add additional rope equal to parts of line times added travel distance. Hoisting distance or line pull may be limited when block travel below ground is required.

Front and rear drums each provide 131 kN (29,500 lb) maximum single line pull. Auxiliary drum provides 89 kN (20,000 lb) maximum single line pull.

Wire Rope Lengths - Fixed Jib No. 138 on Luffing Jib No. 135 on Boom No. 82 or No. 22EL

Boom, Luffing Jib, and Fixed Jib Length	Whip Line	
	Front or Aux Drum (1 Part of line)	
	m	(ft)
100,6 (330)	210	(690)
103,6 (340)	216	(710)
106,7 (350)	223	(730)
109,7 (360)	229	(750)
112,8 (370)	235	(770)
115,8 (380)	241	(790)
118,9 (390)	247	(810)
121,9 (400)	253	(830)
125,0 (410)	259	(850)
128,0 (420)	265	(870)
131,1 (430)	271	(890)

NOTE: Line lengths given in table will allow hook to touch ground. When block travel below ground is required, add additional rope equal to parts of line times added travel distance. Hoisting distance or line pull may be limited when block travel below ground is required.

Front and rear drums each provide 131 kN (29,500 lb) maximum single line pull.

Auxiliary drum provides 89 kN (20,000 lb) maximum single line pull.

model 999



performance data

25

Wire Rope Lengths
Boom No. 82LR
 - or -
Fixed Jib No. 134 or No. 123 on
Boom No. 82LR

Boom or Boom and Fixed Jib Length	Whip Line				Hoist line		Maximum Required Parts of Line
	Front or Aux Drum (1 Part of Line)		Front or Aux Drum (2 Parts of Line)		Rear Drum		
	m	(ft)	m	(ft)	m	(ft)	
36,6 (120)	85	(280)	-	-	396	(1,300)	9
39,6 (130)	91	(300)	-	-	427	(1,400)	9
42,7 (140)	98	(320)	-	-	457	(1,500)	9
45,7 (150)	104	(340)	152	(500)	488	(1,600)	9
48,8 (160)	110	(360)	162	(530)	488	(1,600)	8
51,8 (170)	116	(380)	171	(560)	495	(1,625)	8
54,9 (180)	122	(400)	180	(590)	495	(1,625)	7
57,9 (190)	128	(420)	189	(620)	495	(1,625)	7
61,0 (200)	134	(440)	198	(650)	495	(1,625)	6
64,0 (210)	140	(460)	207	(680)	495	(1,625)	6
67,1 (220)	146	(480)	216	(710)	495	(1,625)	6
70,1 (230)	152	(500)	226	(740)	495	(1,625)	5
73,2 (240)	158	(520)	235	(770)	495	(1,625)	5
76,2 (250)	165	(540)	244	(800)	495	(1,625)	4
79,2 (260)	171	(560)	253	(830)	495	(1,625)	4
82,3 (270)	177	(580)	262	(860)	495	(1,625)	4
85,3 (280)	183	(600)	271	(890)	495	(1,625)	3
88,4 (290)	189	(620)	280	(920)	495	(1,625)	3
91,4 (300)	195	(640)	290	(950)	495	(1,625)	3
94,5 (310)	201	(660)	299	(980)	495	(1,625)	3
97,5 (320)	207	(680)	308	(1,010)	495	(1,625)	3
100,6 (330)	213	(700)	317	(1,040)	495	(1,625)	2
103,6 (340)	219	(720)	326	(1,070)	495	(1,625)	2
106,7 (350)	226	(740)	335	(1,100)	-	-	-
109,7 (360)	232	(760)	344	(1,130)	-	-	-
112,8 (370)	238	(780)	-	-	-	-	-
115,8 (380)	244	(800)	-	-	-	-	-

NOTE: Line lengths given in table will allow hook to touch ground. When block travel below ground is required, add additional rope equal to parts of line times added travel distance. Hoisting distance or line pull may be limited when block travel below ground is required.

Front and rear drums each provide 131 kN (29,500 lb) maximum single line pull.
 Auxiliary drum provides 89 kN (20,000 lb) maximum single line pull.

model 999



performance data

26

PRELIMINARY

Wire Rope Lengths
Boom No. 22E with Open Throat Top
 - or -
Fixed Jib No. 123 on
Boom No. 22E with Open Throat Top

Boom or Boom and Fixed Jib Length	Whip Line				Hoist line				Auxiliary Hoist Line*			
	Rear Drum (1 part of line)		Rear Drum (2 parts of line)		Front Drum		Maximum Required parts of line		Auxiliary Drum		Maximum Required parts of line	
	m (ft)	m (ft)	m (ft)	m (ft)	m (ft)	Inline	Offset	m (ft)	Inline	Offset		
21,3 (70)	55 (180)	79 (260)	351 (1,150)	14	14	-	-	-	-			
24,4 (80)	61 (200)	88 (290)	396 (1,300)	14	12	396 (1,300)	14	14	14			
27,4 (90)	67 (220)	98 (320)	411 (1,350)	13	11	442 (1,450)	14	14	14			
30,5 (100)	73 (240)	107 (350)	457 (1,500)	13	10	488 (1,600)	14	14	14			
33,5 (110)	79 (260)	116 (380)	457 (1,500)	11	10	533 (1,750)	14	14	14			
36,6 (120)	85 (280)	125 (410)	465 (1,525)	11	9	579 (1,900)	14	13	13			
39,6 (130)	91 (300)	134 (440)	465 (1,525)	10	8	625 (2,050)	14	12	12			
42,7 (140)	98 (320)	143 (470)	465 (1,525)	9	8	671 (2,200)	14	12	12			
45,7 (150)	104 (340)	152 (500)	480 (1,575)	9	8	671 (2,200)	13	11	11			
48,8 (160)	110 (360)	162 (530)	480 (1,575)	8	8	671 (2,200)	12	11	11			
51,8 (170)	116 (380)	171 (560)	488 (1,600)	8	7	671 (2,200)	11	10	10			
54,9 (180)	122 (400)	180 (590)	488 (1,600)	7	7	671 (2,200)	10	10	10			
57,9 (190)	128 (420)	189 (620)	488 (1,600)	7	6	671 (2,200)	10	9	9			
61,0 (200)	134 (440)	198 (650)	488 (1,600)	6	6	671 (2,200)	9	9	9			
64,0 (210)	140 (460)	207 (680)	488 (1,600)	6	6	671 (2,200)	8	8	8			
67,1 (220)	146 (480)	216 (710)	488 (1,600)	6	5	671 (2,200)	8	8	8			
70,1 (230)	152 (500)	226 (740)	488 (1,600)	5	5	671 (2,200)	7	7	7			
73,2 (240)	158 (520)	235 (770)	488 (1,600)	5	4	671 (2,200)	7	6	6			
76,2 (250)	165 (540)	244 (800)	488 (1,600)	4	4	671 (2,200)	6	6	6			
79,2 (260)	171 (560)	253 (830)	488 (1,600)	4	4	671 (2,200)	6	5	5			
82,3 (270)	177 (580)	262 (860)	488 (1,600)	4	3	671 (2,200)	5	5	5			
85,3 (280)	183 (600)	271 (890)	488 (1,600)	3	3	671 (2,200)	5	4	4			
88,4 (290)	189 (620)	280 (920)	488 (1,600)	3	3	671 (2,200)	4	4	4			
91,4 (300)	195 (640)	290 (950)	-	-	-	-	-	-	-			
94,5 (310)	201 (660)	-	-	-	-	-	-	-	-			
97,5 (320)	207 (680)	-	-	-	-	-	-	-	-			

NOTE: Line lengths given in table will allow hook to touch ground. When block travel below ground is required, add additional rope equal to parts of line times added travel distance. Hoisting distance or line pull may be limited when block travel below ground is required.

Front and rear drums each provide 131 kN (29,500 lb) maximum single line pull.
 Auxiliary drum provides 89 kN (20,000 lb) maximum single line pull.

*Wire rope lengths greater than 625 m (2,050') cannot be stored on auxiliary drum. Auxiliary drum cannot be used with 21,3 m (70') boom.
 Capacity chart restrictions will occur when auxiliary drum is used. Auxiliary drum maximum capacity is 127 010 kg (280,000 lb) with 14 parts line.

PRELIMINARY

Wire Rope Lengths
Boom No. 22E with Light Tapered Top
 - or -
No. 123 Fixed Jib on
Boom No. 22E with Light Tapered Top

Boom or Boom and Fixed Jib Length	Whip Line				Hoist line		
	Rear or Aux Drum (1 Part of Line)		Rear or Aux Drum (2 Parts of Line)		Front Drum	Maximum Required Parts of Line	
	m	(ft)	m	(ft)			
33,5 (110)	79	(260)	116	(380)	358	(1,175)	9
36,6 (120)	85	(280)	125	(410)	389	(1,275)	9
39,6 (130)	91	(300)	134	(440)	419	(1,375)	9
42,7 (140)	98	(320)	143	(470)	450	(1,475)	9
45,7 (150)	104	(340)	152	(500)	450	(1,475)	8
48,8 (160)	110	(360)	162	(530)	457	(1,500)	8
51,8 (170)	116	(380)	171	(560)	457	(1,500)	7
54,9 (180)	122	(400)	180	(590)	457	(1,500)	7
57,9 (190)	128	(420)	189	(620)	457	(1,500)	6
61,0 (200)	134	(440)	198	(650)	457	(1,500)	6
64,0 (210)	140	(460)	207	(680)	465	(1,525)	6
67,1 (220)	146	(480)	216	(710)	465	(1,525)	5
70,1 (230)	152	(500)	226	(740)	465	(1,525)	5
73,2 (240)	158	(520)	235	(770)	495	(1,525)	5
76,2 (250)	165	(540)	244	(800)	465	(1,525)	4
79,2 (260)	171	(560)	253	(830)	465	(1,525)	4
82,3 (270)	177	(580)	262	(860)	465	(1,525)	4
85,3 (280)	183	(600)	271	(890)	465	(1,525)	3
88,4 (290)	189	(620)	280	(920)	465	(1,525)	3
91,4 (300)	195	(640)	290	(950)	495	(1,525)	3
94,5 (310)	201	(660)	299	(980)	465	(1,525)	3
97,5 (320)	207	(680)	308	(1,010)	-	-	-
100,6 (330)	213	(700)	317	(1,040)	-	-	-
103,6 (340)	219	(720)	-	-	-	-	-
106,7 (350)	226	(740)	-	-	-	-	-

NOTE: Line lengths given in table will allow hook to touch ground. When block travel below ground is required, add additional rope equal to parts of line times added travel distance. Hoisting distance or line pull may be limited when block travel below ground is required.

Front and rear drums each provide 131 kN (29,500 lb) maximum single line pull.
 Auxiliary drum provides 89 kN (20,000 lb) maximum single line pull.

performance data

28

Wire Rope Specifications 5:1 Safety Factor					
Boom No. 82 or No. 22EL or					
Boom No. 82 with No. 82 Long Reach Top or					
Boom No. 22E with Open Throat Top or					
Boom No. 22E with Light Tapered Top					
- or -					
Fixed Jib No. 134 on Boom No. 82 or No. 22EL or					
Fixed Jib No. 134 on Boom No. 82LR or					
Fixed Jib No. 123 on Boom No. 82 with Long Reach Top or					
Fixed Jib No. 123 on Boom No. 22E with Open Throat Top or					
Fixed Jib No. 123 on Boom No. 22E with Light Tapered Top					
Function	5:1 Safety Factor Rotation Resistant, 2 160 N/mm ² Wire rope with Pad Eye			5:1 Safety Factor Rotation Resistant, 1 960 N/mm ² Wire rope	
	Hoist Line	Whip Line	Maximum Capacity Hoist Line	Auxiliary Line	
Part Number	No. 719431	No. 719431 No. 719430 No. 719432	No. 719430 No. 719432	No. 719378 No. 719434	No. 719393
Size Wire Rope	26 mm	26 mm	26 mm	26mm	- (1")
Minimum Breaking Strength	656,1 kN (147,500 lb)	656,1 kN (147,500 lb)	695,3 kN (156,250 lb)	445,0 kN (100,000 lb)	445,0 kN (100,000 lb)
Maximum Load Per Line	13 380 kg (29,500 lb)	13 380 kg (29,500 lb)	14 175 kg (31,250 lb)	9 070 kg (20,000 lb)	9 070 kg (20,000 lb)
Approximate Weight	3,39 kg/m (2.28 lb/ft)	3,39 kg/m (2.28 lb/ft)	3,56 kg/m (2.39 lb/ft)	3,17 kg/m (2.13 lb/ft)	3,02 kg/m (2.03 lb/ft)

performance data

29

Wire Rope Specifications 3.5:1 Safety Factor
Boom No. 82 or No. 22EL or
Boom No. 82 with No. 82 Long Reach Top or
Boom No. 22E with Open Throat Top or
Boom No. 22E with Light Tapered Top
- or -
Fixed Jib No. 134 on Boom No. 82 or No. 22EL or
Fixed Jib No. 134 on Boom No. 82LR or
Fixed Jib No. 123 on Boom No. 82 with Long Reach Top or
Fixed Jib No. 123 on Boom No. 22E with Open Throat Top or
Fixed Jib No. 123 on Boom No. 22E with Light Tapered Top

Function	3.5:1 Safety Factor 6 x 25 Filler Wire, EIPS Right Regular Lay, IWRC			Maximum Capacity	
	Hoist Line	Whip Line	Hoist Line	Auxiliary Line	
Part Number	No. 719387	No. 719387	No. 719383*	No. 719387	No. 719433**
Size Wire Rope	26 mm -	26 mm -	26 mm -	26mm -	- (1")
Minimum Breaking Strength	459,5 kN (103,250 lb)	459,5 kN (103,250 lb)	536,1 kN (119,400 lb)	311,5 kN (70,000 lb)	311,5 kN (70,000 lb)
Maximum Load Per Line	13 380 kg (29,500 lb)	13 380 kg (29,500 lb)	14 175 kg (31,250 lb)	9 070 kg (20,000 lb)	9 070 kg (20,000 lb)
Approximate Weight	2,89 kg/m (1.94 lb/ft)	2,89 kg/m (1.94 lb/ft)	2,89 kg/m (1.94 lb/ft)	2,89 kg/m (1.94 lb/ft)	2,75 kg/m (1.85 lb/ft)

* EEIPS wire rope

** IPS wire rope

performance data

30

Wire Rope Specifications 5:1 Safety Factor

No. 138 Fixed Jib on
No. 135 Luffing Jib on
Boom No. 82 or No. 22EL

- or -

No. 134 Fixed Jib on
No. 149 Luffing Jib on
Boom No. 82

Function	5:1 Safety Factor Rotation Resistant 2 160 N/mm ² Wire rope with Pad Eye		5:1 Safety Factor Rotation Resistant 1 960 N/mm ² Wire rope	
	Whip Line		Auxiliary Drum Whip Line	
Part Number	No. 719431		No. 719378 No. 719434	No. 719393
Size Wire Rope	26 mm -		26mm -	- (1")
Minimum Breaking Strength	656,1 kN (147,500 lb)		445,0 kN (100,000 lb)	445,0 kN (100,000 lb)
Maximum Load Per Line	13 380 kg* (29,500 lb)*		9 070 kg (20,000 lb)	9 070 kg (20,000 lb)
Approximate Weight	3,39 kg/m (2.28 lb/ft)		3,17 kg/m (2.13 lb/ft)	3,02 kg/m (2.03 lb/ft)

* 12 474 kg (27,500 lb) for No. 138 Fixed Jib Extension.

performance data

31

Wire Rope Specifications 3.5:1 Safety Factor

No. 138 Fixed Jib on
No. 135 Luffing Jib on
Boom No. 82 or No. 22EL

- or -

No. 134 Fixed Jib on
No. 149 Luffing Jib on
Boom No. 82

Function	3.5:1 Safety Factor 6 x 25 Filler Wire, EIPS Right Regular Lay, IWRC		3.5:1 Safety Factor 6 x 25 Filler Wire, EIPS Right Regular Lay, IWRC	
	Whip Line		Auxiliary Drum Whip Line	
Part Number	No. 719387		No. 719387	No. 719433**
Size Wire Rope	26 mm -		26mm -	- (1")
Minimum Breaking Strength	459,5 kN (103,250 lb)		311,5 kN (70,000 lb)	311,5 kN (70,000 lb)
Maximum Load Per Line	13 380 kg* (29,500 lb)*		9 070 kg (20,000 lb)	9 070 kg (20,000 lb)
Approximate Weight	2,89 kg/m (1.94 lb/ft)		2,89 kg/m (1.94 lb/ft)	2,75 kg/m (1.85 lb/ft)

* 12 474 kg (27,500 lb) for No. 138 Fixed Jib Extension.

**IPS wire rope

performance data

32

Main & Whip Drums - 131 kN (29,500 lb)

Layer	Full Power Drum - Continuous Duty Single Line Pull/Single Line Speed						
	m/min (ft/min)						
	1	2	3	4	5	6	7
Line Pull kg (lb)							
0 (0)	87 (285)	95 (310)	102 (335)	110 (360)	119 (390)	127 (415)	134 (440)
2 268 (5,000)	82 (270)	90 (295)	98 (320)	105 (345)	111 (365)	119 (390)	127 (415)
4 536 (10,000)	79 (260)	87 (285)	93 (305)	99 (325)	105 (345)	111 (365)	117 (385)
6 803 (15,000)	76 (250)	82 (270)	88 (290)	93 (305)	96 (315)	98 (320)	99 (325)
9 072 (20,000)	72 (235)	73 (240)	75 (245)	76 (250)	78 (255)	79 (260)	81 (265)
11 340 (25,000)	61 (200)	63 (205)	64 (210)	66 (215)	67 (220)	69 (225)	70 (230)
13 380 (29,500)	53 (175)	55 (180)	56 (185)	58 (190)	59 (195)	61 (200)	63 (205)

NOTE: Line pull is infinitely variable.

Auxiliary Drum - 89,0 kN (20,000 lb)

Layer	Full Power Drum - Continuous Duty Single Line Pull/Single Line Speed		
	m/min (ft/min)		
	1	4	6
Line Pull kg (lb)			
0 (0)	116 (380)	146 (480)	168 (550)
2 268 (5,000)	110 (360)	137 (450)	156 (510)
4 536 (10,000)	104 (340)	128 (420)	143 (470)
6 803 (15,000)	95 (310)	98 (320)	98 (320)
9 072 (20,000)	73 (240)	76 (250)	82 (270)

NOTE: Line pull is infinitely variable.

Drum Capacities - Wire Rope

	Maximum Length	
	No Lagging	With Lagging
Front or Rear Grooved Drum 26 mm Wire Rope*	526 m (1,727 ft) 7 Layers	-
Auxiliary Drum 26 mm Wire Rope*	403 m (1,323 ft) 6 Layers	431 m (1,415 ft) 6 Layers
Auxiliary Drum (1") Wire Rope*	407 m (1,335 ft) 6 Layers	435 m (1,428 ft) 6 Layers
Boom Hoist Drum 22,23 mm (7/8") Wire Rope	323 m (1,060 ft) 6 Layers	-

*5 m (17') is deducted from maximum spooling capacities for 3 dead wraps per drum or lagging.

Working Weight

Configuration	kg (lb)		
	Series 1	Series 2	Series 3
21,3 m (70') No. 82 Boom	161 081 (355,124)	196 924 (434,144)	229 138 (505,164)
76,2 m (250') No. 82 Boom combined with 24,4 m (80') No. 134 Fixed Jib	-	210 026 (463,028)	242 240 (534,048)
61,0 m (200') No. 82 Boom combined with 51,8 m (170') No. 135 Luffing Jib	177 973* (392,364)*	216 074** (476,362)**	248 711 (548,315)

Typical working weight includes optional self-assembly carbody jacks, hydraulic reservoir full, fuel half-full, drums with standard lengths of wire rope, upper boom point, 227 mt (250 t) hook block, and 13,6 mt (15 t) hook and weight ball.

Note: Upper boom point not used with fixed jib or luffing jib.

*48,8 m (160') No. 82 boom maximum allowed.

**57,9 m (190') No. 82 boom maximum allowed.

performance data

33

Maximum Length – Unassisted Raising

	No. 82 or No. 22EL Main Boom - or - No. 134 Fixed Jib on No. 82 or No. 22EL Main Boom Series 3	
	Main Boom	Fixed Jib
Over end of blocked crawlers or side of crawlers m (ft)	88,4 (290)	–
	85,3 (280)	–
	82,3 (270)	9,1 (30)
	79,2 (260)	18,3 (60)
	76,2 (250)	24,4 (80)

NOTE: Load block(s), hook(s) and weight ball(s) on ground at start.
Upper boom point cannot be used on 88,4 m (290') boom, or when jib is attached.
Boom lengths of 76,2 m (250') through 88,4 m (290') require only two middle sheaves in lower boom point, all others must be removed from lower boom point.

PRELIMINARY

Maximum Length – Unassisted Raising

	No. 134 Fixed Jib on No. 149 Luffing Jib on No. 82 Main Boom Series 3		
	Layout Jack-Knife Method		
	Main Boom	Luffing Jib#	Fixed Jib
Over end of blocked crawlers m (ft)	57,9* (190)*	45,7 - 64,0 (150 - 210)	9,1 - 24,4 (30 - 80)
	61,0* (200)*	45,7 - 51,8 (150 - 170)	9,1 - 24,4 (30 - 80)

NOTE: Load block(s), hook(s) and weight ball(s) on ground at start.
#Without intermediate fall.
*Requires lower boom point to be removed.

PRELIMINARY

Maximum Length – Unassisted Raising

	No. 149 Luffing Jib on No. 82 Main Boom Series 3			
	Layout Jack-Knife Method			
	Main Boom	Luffing Jib**	Main Boom	Luffing Jib***
Over end of blocked crawlers m (ft)	24,4 (80)	21,3 - 73,2 (70 - 240)	24,4 (80)	21,3 - 73,2 (70 - 240)
	27,4 (90)	21,3 - 73,2 (70 - 240)	27,4 (90)	21,3 - 73,2 (70 - 240)
	30,5 (100)	21,3 - 73,2 (70 - 240)	30,5 (100)	21,3 - 73,2 (70 - 240)
	33,5 (110)	21,3 - 73,2 (70 - 240)	33,5 (110)	21,3 - 73,2 (70 - 240)
	36,6 (120)	21,3 - 73,2 (70 - 240)	36,6 (120)	21,3 - 73,2 (70 - 240)
	39,6 (130)	21,3 - 73,2 (70 - 240)	39,6 (130)	21,3 - 73,2 (70 - 240)
	42,7 (140)	21,3 - 73,2 (70 - 240)	42,7 (140)	21,3 - 73,2 (70 - 240)
	45,7 (150)	21,3 - 73,2 (70 - 240)	45,7 (150)	21,3 - 73,2 (70 - 240)
	48,8 (160)	21,3 - 73,2 (70 - 240)	48,8 (160)	21,3 - 73,2 (70 - 240)
	51,8 (170)	21,3 - 73,2 (70 - 240)	51,8 (170)	21,3 - 73,2 (70 - 240)
	54,9 (180)	21,3 - 73,2 (70 - 240)	54,9 (180)	21,3 - 57,9 (70 - 190)
	57,9# (190) #	21,3 - 57,9 (70 - 190)	57,9# (190) #	21,3 - 48,8 (70 - 160)
	61,0* (200) *	21,3 - 51,8 (70 - 170)	61,0* (200) *	21,3 - 39,6 (70 - 130)

NOTE: Load block(s), hook(s) and weight ball(s) on ground at start.
#Requires only two middle sheaves in lower boom point, all others must be removed from lower boom point.
*Requires lower boom point to be removed.
**With intermediate fall.
***Without intermediate fall.

performance data

34

Maximum Length – Unassisted Raising

	No. 138 Fixed Jib on No. 135 Luffing Jib on No. 82 or No. 22EL Main Boom Series 3			
	Main Boom	Fixed Jib	Layout	Fold Under
			Jack-Knife Method Luffing Jib	Jack-Knife Method Luffing Jib
Over end of blocked crawlers m (ft)	48,8 (160)	9,1 - 18,3 (30 - 60)	42,7 - 51,8 (140 - 170)	42,7 (140)
	51,8 (170)	9,1 - 18,3 (30 - 60)	42,7 - 51,8 (140 - 170)	42,7 - 45,7 (140 - 150)
	54,9 (180)	9,1 - 18,3 (30 - 60)	42,7 - 51,8 (140 - 170)	42,7 - 48,8 (140 - 160)
	57,9# (190)#	9,1 - 18,3 (30 - 60)	42,7 - 51,8 (140 - 170)	42,7 - 51,8 (140 - 170)
	61,0* (200)*	9,1 - 18,3 (30 - 60)	42,7 - 51,8 (140 - 170)	42,7 - 51,8 (140 - 170)

NOTE: Load block(s), hook(s) and weight ball(s) on ground at start.
#Requires only two middle sheaves in lower boom point, all others must be removed from lower boom point.
*Lower boom point must be removed.

Maximum Length – Unassisted Raising

	No. 135 Luffing Jib on No. 82 or No. 22EL Main Boom Series 3					
	Layout		Layout		Fold Under	
	Main Boom	Luffing Jib	Jack-Knife Method Main Boom	Jack-Knife Method Luffing Jib	Jack-Knife Method Main Boom	Jack-Knife Method Luffing Jib
Over end of blocked crawlers m (ft)	21,3 (70)	21,3 - 51,8 (70 - 170)	39,6 (130)	51,8 (170)	27,4 (90)	21,3 (70)
	24,4 (80)	21,3 - 51,8 (70 - 170)	42,7 (140)	48,8 - 51,8 (160 - 170)	30,5 (100)	21,3 - 24,4 (70 - 80)
	27,4 (90)	21,3 - 51,8 (70 - 170)	45,7 (150)	39,6 - 51,8 (130 - 170)	33,5 (110)	21,3 - 27,4 (70 - 90)
	30,5 (100)	21,3 - 51,8 (70 - 170)	48,8 (160)	33,5 - 51,8 (110 - 170)	36,6 (120)	21,3 - 30,5 (70 - 100)
	33,5 (110)	21,3 - 51,8 (70 - 170)	51,8 (170)	27,4 - 51,8 (90 - 170)	39,6 (130)	21,3 - 33,5 (70 - 110)
	36,6 (120)	21,3 - 51,8 (70 - 170)	54,9 (180)	21,3 - 51,8 (70 - 170)	42,7 (140)	21,3 - 36,6 (70 - 120)
	39,6 (130)	21,3 - 48,8 (70 - 160)	57,9# (190) #	21,3 - 51,8 (70 - 170)	45,7 (150)	21,3 - 39,6 (70 - 130)
	42,7 (140)	21,3 - 45,7 (70 - 150)	61,0* (200) *	21,3 - 51,8 (70 - 170)	48,8 (160)	21,3 - 42,7 (70 - 140)
	45,7 (150)	21,3 - 36,6 (70 - 120)			51,8 (170)	21,3 - 45,7 (70 - 150)
	48,8 (160)	21,3 - 30,5 (70 - 100)			54,9 (180)	21,3 - 48,8 (70 - 160)
	51,8 (170)	21,3 - 24,4 (70 - 80)			57,9# (190)#	21,3 - 51,8 (70 - 170)
					61,0* (200)*	21,3 - 51,8 (70 - 170)

NOTE: Load block(s), hook(s) and weight ball(s) on ground at start.
#Requires only two middle sheaves in lower boom point, all others must be removed from lower boom point.
*Lower boom point must be removed.

performance data

35

PRELIMINARY

Maximum Length – Unassisted Raising

	No. 82LR Boom - or - No. 134 Fixed Jib on No. 82LR Boom Series 3	
	Main Boom	Fixed Jib
Over end of blocked crawlers m (ft)	103,6 (340)	-
	91,4 (300)	24,4 (80)

NOTE: Load block(s), hook(s) and weight ball(s) on ground at start. Upper boom point cannot be used when jib is attached. Upper boom point cannot be used on 103,6 m (340') boom.

PRELIMINARY

Maximum Length – Unassisted Raising

	No. 82LR Boom - or - No. 123 Fixed Jib on No. 82LR Boom Series 3	
	Main Boom	Fixed Jib
Over end of blocked crawlers m (ft)	103,6 (340)	-
	91,4 (300)	18,3 (60)

NOTE: Load block(s), hook(s) and weight ball(s) on ground at start. Upper boom point cannot be used when jib is attached. Upper boom point cannot be used on 103,6 m (340') boom.

Maximum Length – Unassisted Raising

	No.22E Boom with Light Tapered Top - or - No. 123 Fixed Jib on No.22E Boom with Light Tapered Top Series 3	
	Main Boom	Fixed Jib
Over end of blocked crawlers m (ft)	94,5 (310)	-
	91,4 (300)	9,1 (30)
	88,4 (290)	18,3 (60)

NOTE: Load block(s), hook(s) and weight ball(s) on ground at start. Upper boom point cannot be used when jib is attached. Upper boom point cannot be used on 94,5 m (310') boom.

Maximum Length – Unassisted Raising

	No.22E Boom with Open Throat Top - or - No. 123 Fixed Jib on No.22E Boom with Open Throat Top Series 3	
	Main Boom	Fixed Jib
Over end of blocked crawlers m (ft)	88,4 (290)	-
	85,3 (280)	-
	82,3 (270)	9,1 (30)
	79,2 (260)	18,3 (60)

NOTE: Load block(s), hook(s) and weight ball(s) on ground at start. Upper boom point cannot be used when jib is attached. Upper boom point cannot be used on 88,4 m (290') boom.

Main Boom Attachments

Main Boom (with Top)	Fixed Jib	Luffing Jib	Fixed Jib (Extension)
No. 82* (Heavy-Lift)	No. 134	No. 149* No. 135	No. 134 No. 138
No. 82LR* (Long-Reach Top)	No. 134 No. 123		
No. 22EL (Heavy-Lift)	No. 134	No. 135	No. 138
No. 22E (Open Throat Top)	No. 123		
No. 22E (Light Tapered Top)	No. 123		

*Use straps and FACT™ connections. All others use pendants and pinned connections.

model 999



boom combinations

36

No. 82 or No. 22EL Boom Combinations

Boom Length m (ft)	Boom Inserts		
	3,0 m (10 ft)	6,1 m (20 ft)	12,2 m (40 ft)
21,3 (70)	-	-	-
24,4 (80)	1	-	-
27,4 (90)	-	1	-
30,5 (100)	1	1	-
33,5 (110)	-	-	1
36,6 (120)	1	-	1
39,6 (130)	-	1	1
42,7 (140)	1	1	1
45,7 (150)	-	-	2
48,8 (160)	1	-	2
51,8 (170)	-	1	2
54,9 (180)	1	1	2
57,9 (190)	-	-	3
61,0 (200)	1	-	3
64,0 (210)	-	1	3
67,1 (220)	1	1	3
70,1 (230)	-	-	4
73,2 (240)	1	-	4
76,2 (250)	-	1	4
79,2 (260)	1	1	4
82,3 (270)	-	-	5
85,3 (280)	1	-	5
88,4 (290)	-	1	5

No. 134 Fixed Jib Combinations

Jib Length m (ft)	Fixed Jib Inserts	
	3,0 m (10 ft)	6,1 m (20 ft)
9,1 (30)	-	-
12,2 (40)	1	-
15,2 (50)	-	1
18,3 (60)	1	1
21,3 (70)	-	2
24,4 (80)	1	2

Note: Can be used as fixed jib extension for No. 149 luffing jib.

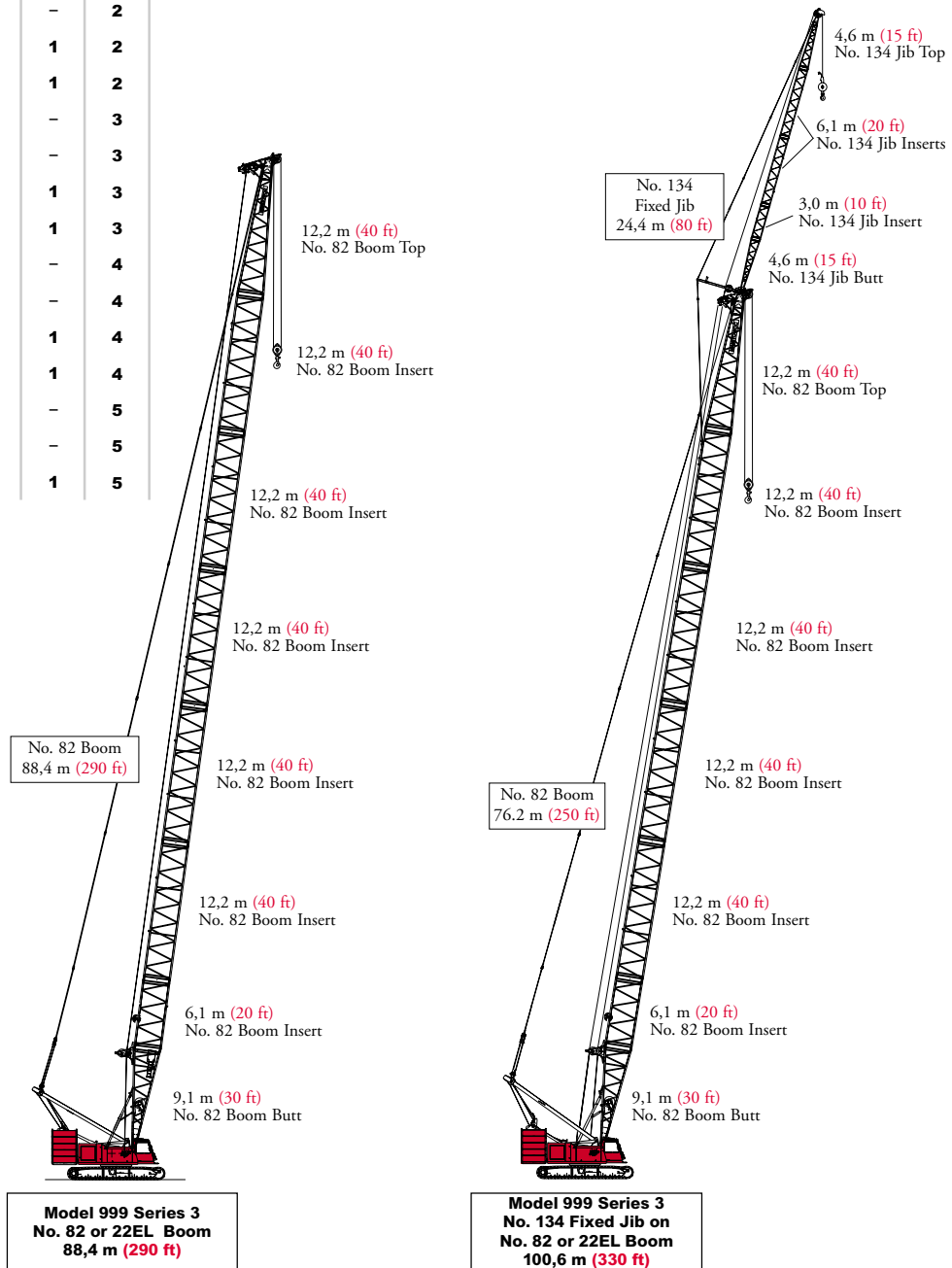

boom combinations

No. 82LR Boom Combinations

Boom Length m (ft)	Boom Inserts			
	3,0 m (10 ft)	6,1 m (20 ft)	12,2 m (40 ft)	12,2 m* (40 ft)*
36,6 (120)	-	-	1	-
39,6 (130)	1	-	1	-
42,7 (140)	-	1	1	-
45,7 (150)	1	1	1	-
48,8 (160)	-	-	2	-
51,8 (170)	1	-	2	-
54,9 (180)	-	1	2	-
57,9 (190)	1	1	2	-
61,0 (200)	-	-	3	-
64,0 (210)	1	-	3	-
67,1 (220)	-	1	3	-
70,1 (230)	1	1	3	-
73,2 (240)	-	-	4	-
76,2 (250)	1	-	4	-
79,2 (260)	-	1	4	-
82,3 (270)	1	1	4	-
85,3 (280)	-	-	5	-
88,4 (290)	1	-	5	-
91,4 (300)	-	1	5	-
94,5 (310)	1	1	4	1
97,5 (320)	-	-	5	1
100,6 (330)	1	-	5	1
103,6 (340)	-	1	5	1

*Light weight insert

No. 123 Fixed Jib Combinations

Jib Length m (ft)	Fixed Jib Inserts	
	3,0 m (10 ft)	6,1 m (20 ft)
9,1 (30)	-	-
12,2 (40)	1	-
15,2 (50)	-	1
18,3 (60)	1	1

Note: No. 123 Fixed Jib can also be used with No. 22E Boom with Open Throat Top or Light Tapered Top.

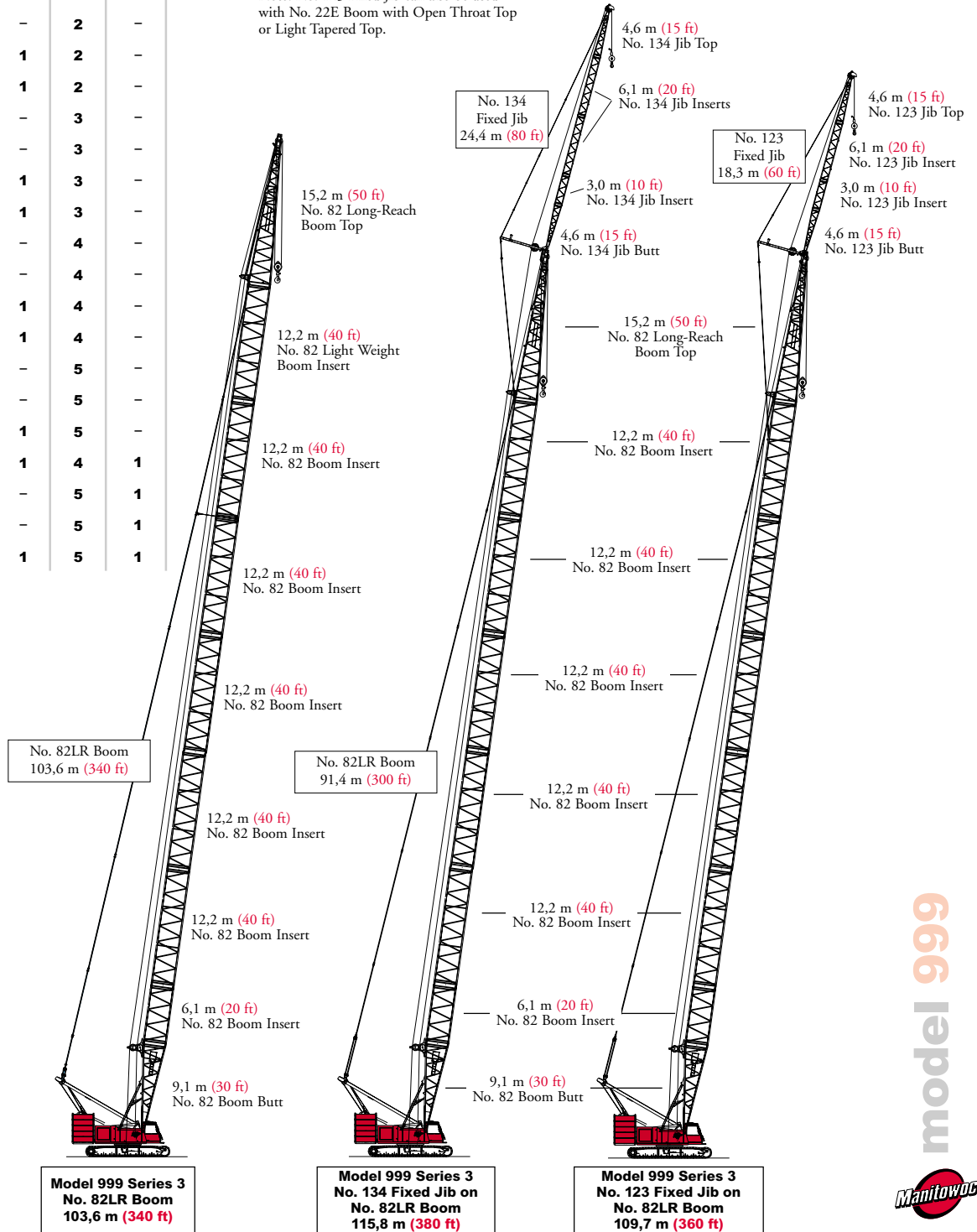

boom combinations

38

No. 22E with Open Throat Top Boom Combinations

Boom Length m (ft)	Boom Inserts		
	3,0 m (10 ft)	6,1 m (20 ft)	12,2 m (40 ft)
21,3 (70)	-	-	-
24,4 (80)	1	-	-
27,4 (90)	-	1	-
30,5 (100)	1	1	-
33,5 (110)	-	-	1
36,6 (120)	1	-	1
39,6 (130)	-	1	1
42,7 (140)	1	1	1
45,7 (150)	-	-	2
48,8 (160)	1	-	2
51,8 (170)	-	1	2
54,9 (180)	1	1	2
57,9 (190)	-	-	3
61,0 (200)	1	-	3
64,0 (210)	-	1	3
67,1 (220)	1	1	3
70,1 (230)	-	-	4
73,2 (240)	1	-	4
76,2 (250)	-	1	4
79,2 (260)	1	1	4
82,3 (270)	-	-	5
85,3 (280)	1	-	5
88,4 (290)	-	1	5

No. 123 Fixed Jib Combinations

Jib Length m (ft)	Fixed Jib Inserts	
	3,0 m (10 ft)	6,1 m (20 ft)
9,1 (30)	-	-
12,2 (40)	1	-
15,2 (50)	-	1
18,3 (60)	1	1

Note: No. 123 Fixed Jib can also be used with No. 82LR Boom.

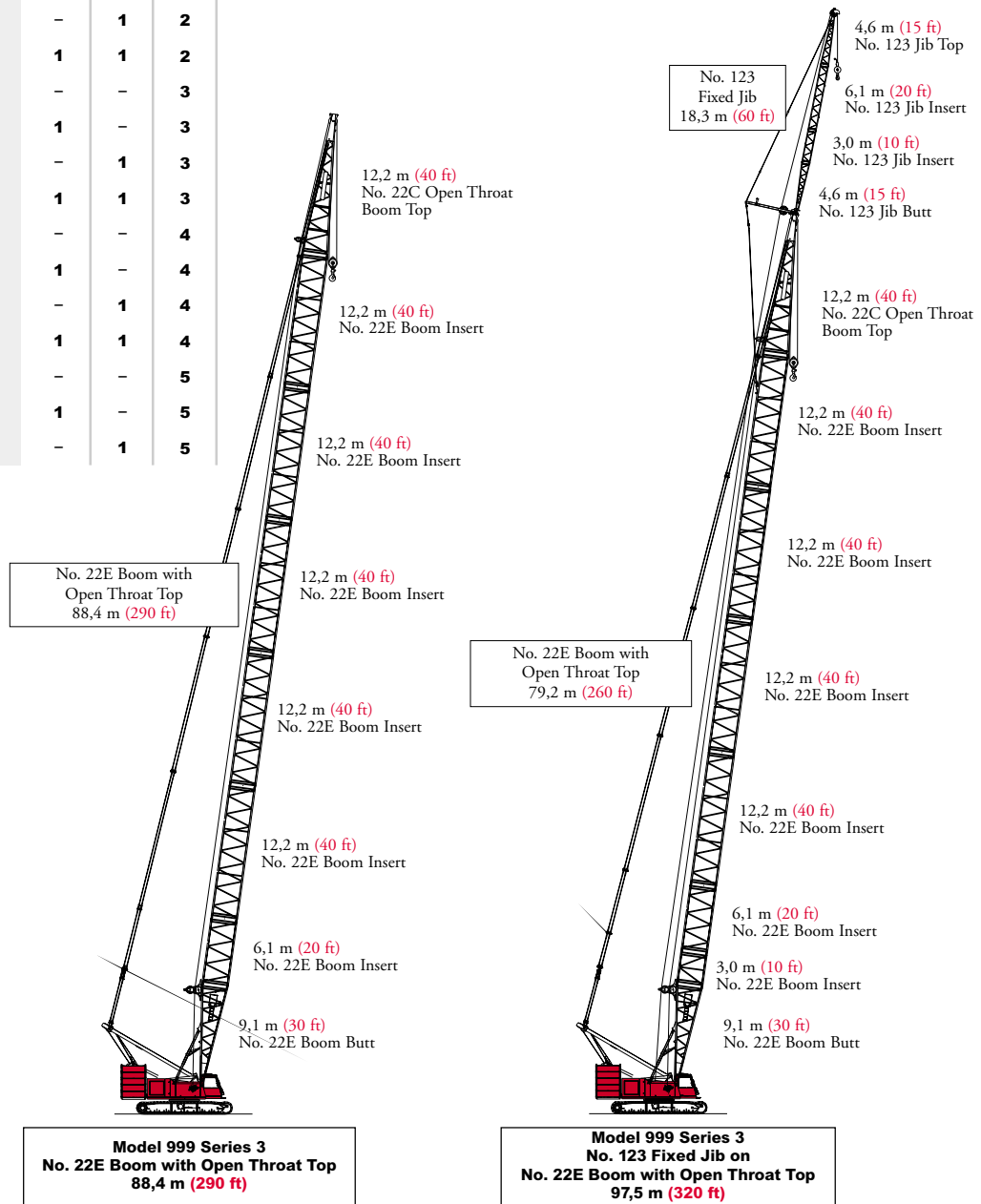

boom combinations

No. 22E with Light Tapered Top & Tapered Insert Boom Combinations

Boom Length m (ft)	Boom Inserts		
	3,0 m (10 ft)	6,1 m (20 ft)	12,2 m (40 ft)
36,6 (120)	1	-	-
39,6 (130)	-	1	-
42,7 (140)	1	1	-
45,7 (150)	-	-	1
48,8 (160)	1	-	1
51,8 (170)	-	1	1
54,9 (180)	1	1	1
57,9 (190)	-	-	2
61,0 (200)	1	-	2
64,0 (210)	-	1	2
67,1 (220)	1	1	2
70,1 (230)	-	-	3
73,2 (240)	1	-	3
76,2 (250)	-	1	3
79,2 (260)	1	1	3
82,3 (270)	-	-	4
85,3 (280)	1	-	4
88,4 (290)	-	1	4
91,4 (300)	1	1	4
94,5 (310)	-	-	5

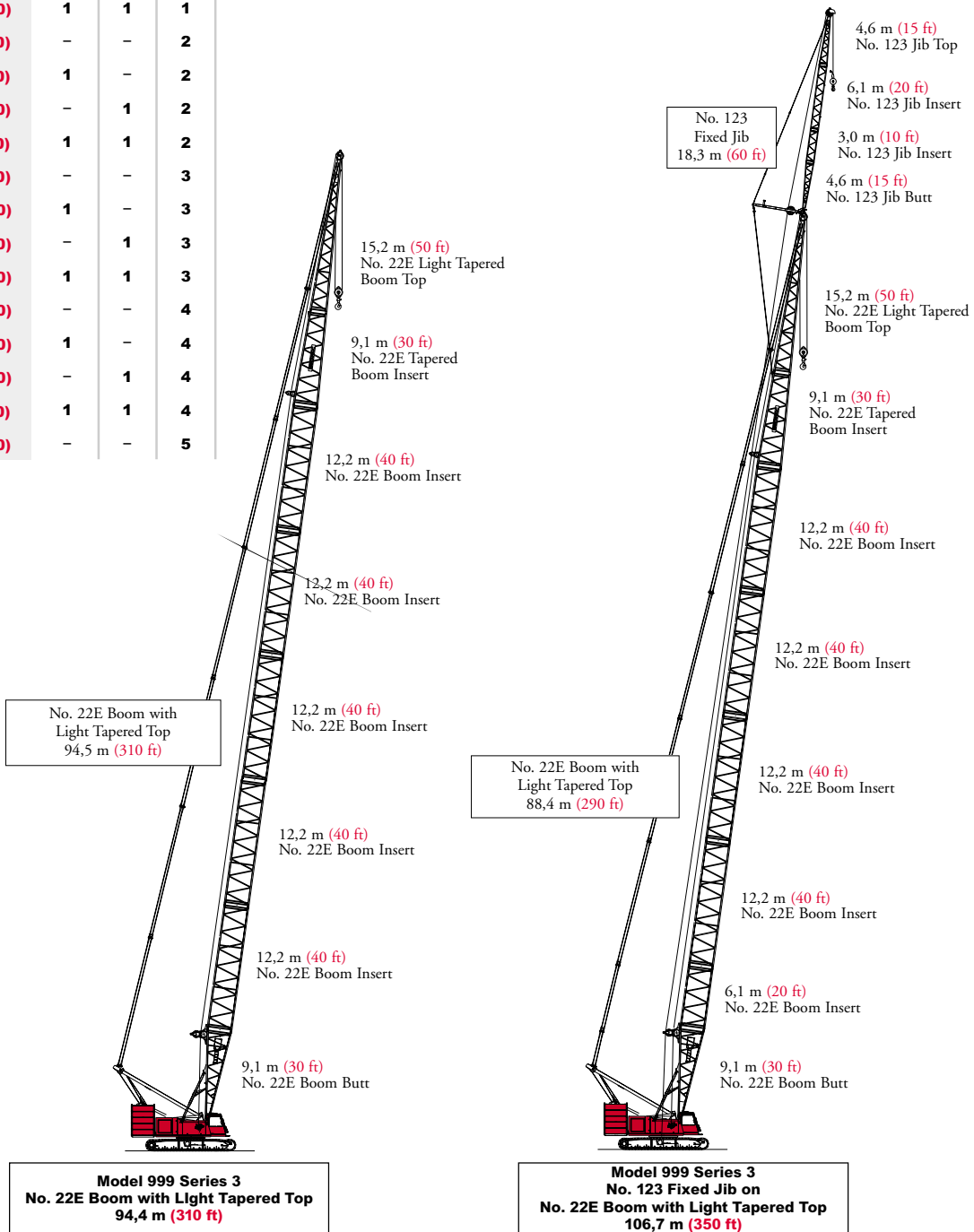

boom combinations

40

No. 135 Luffing Jib Combinations

Jib Length m (ft)	Luffing Jib Inserts		
	3,0 m (10 ft)	6,1 m (20 ft)	12,2 m (40 ft)
21,3 (70)	-	1	-
24,4 (80)	1	1	-
27,4 (90)	-	-	1
30,5 (100)	1	-	1
33,5 (110)	-	1	1
36,6 (120)	1	1	1
39,6 (130)	-	-	2
42,7 (140)	1	-	2
45,7 (150)	-	1	2
48,8 (160)	1	1	2
51,8 (170)	0	0	3

No. 138 Fixed Jib Combinations

Jib Length m (ft)	Fixed Jib Inserts
	3,0 m (10 ft)
9,1 (30)	-
12,2 (40)	1
15,2 (50)	2
18,3 (60)	3

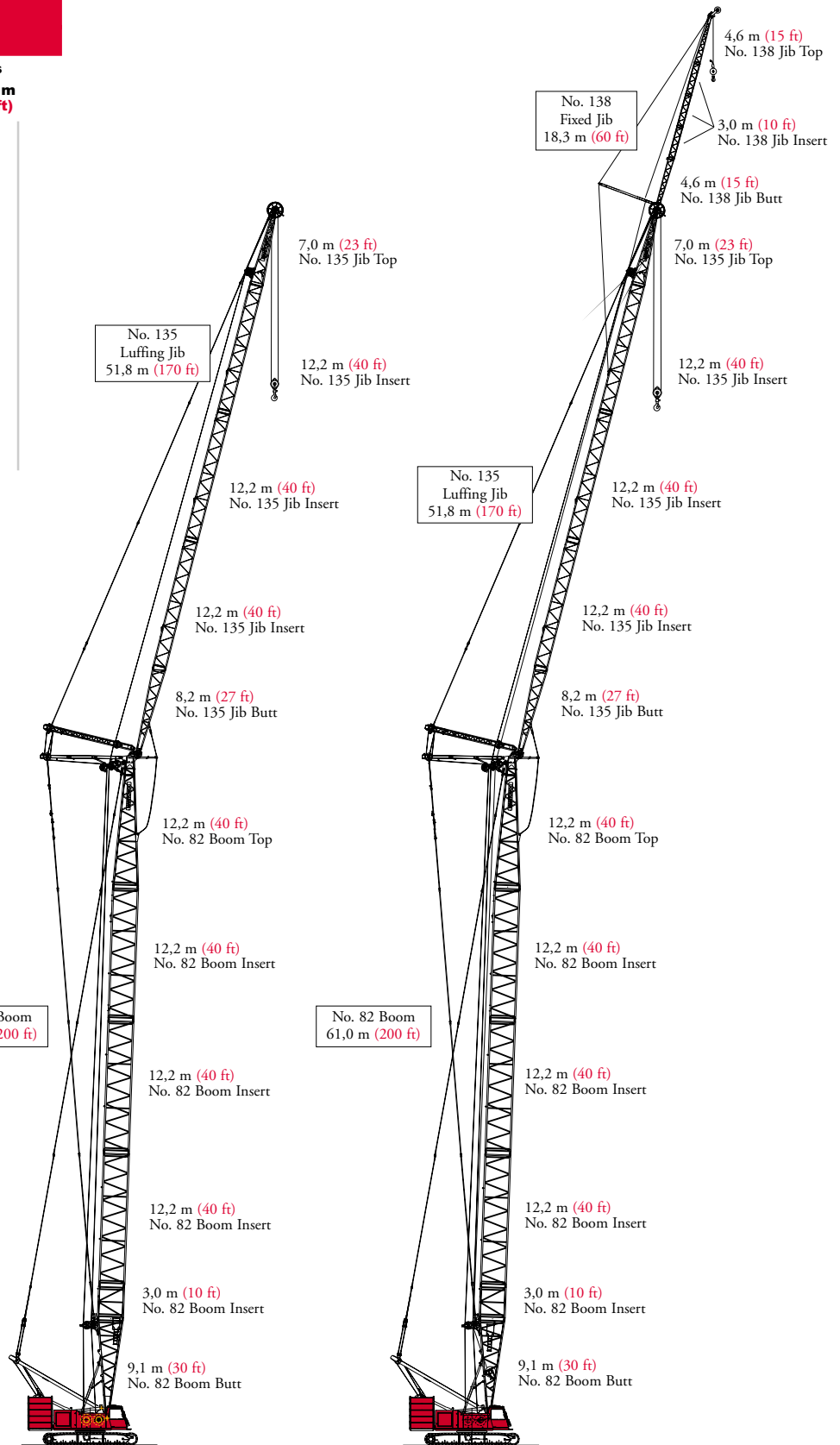

Model 999 Series 3
No. 135 Luffing Jib on
No. 82 or No. 22EL Boom
112,8 m (370 ft)

Model 999 Series 3
No. 138 Fixed Jib on No. 135 Luffing Jib on
No. 82 or No. 22EL Boom
131,1 m (430 ft)

boom combinations

PRELIMINARY

No. 149 Luffing Jib Combinations

Jib Length m (ft)	Luffing Jib Inserts		
	3,0 m (10 ft)	6,1 m (20 ft)	12,2 m (40 ft)
21,3 (70)	-	1	-
24,4 (80)	1	1	-
27,4 (90)	-	-	1
30,5 (100)	1	-	1
33,5 (110)	-	1	1
36,6 (120)	1	1	1
39,6 (130)	-	-	2
42,7 (140)	1	-	2
45,7 (150)	-	1	2
48,8 (160)	1	1	2
51,8 (170)	-	-	3
54,9 (180)	1	-	3
57,9 (190)	-	1	3
61,0 (200)	1	1	3
64,0 (210)	-	-	4
67,1 (220)	1	-	4
70,1 (230)	-	1	4
73,2 (240)	1	1	4

Note: Optional 6,1 m (20') insert with intermediate fall available for No. 149 luffing jib.

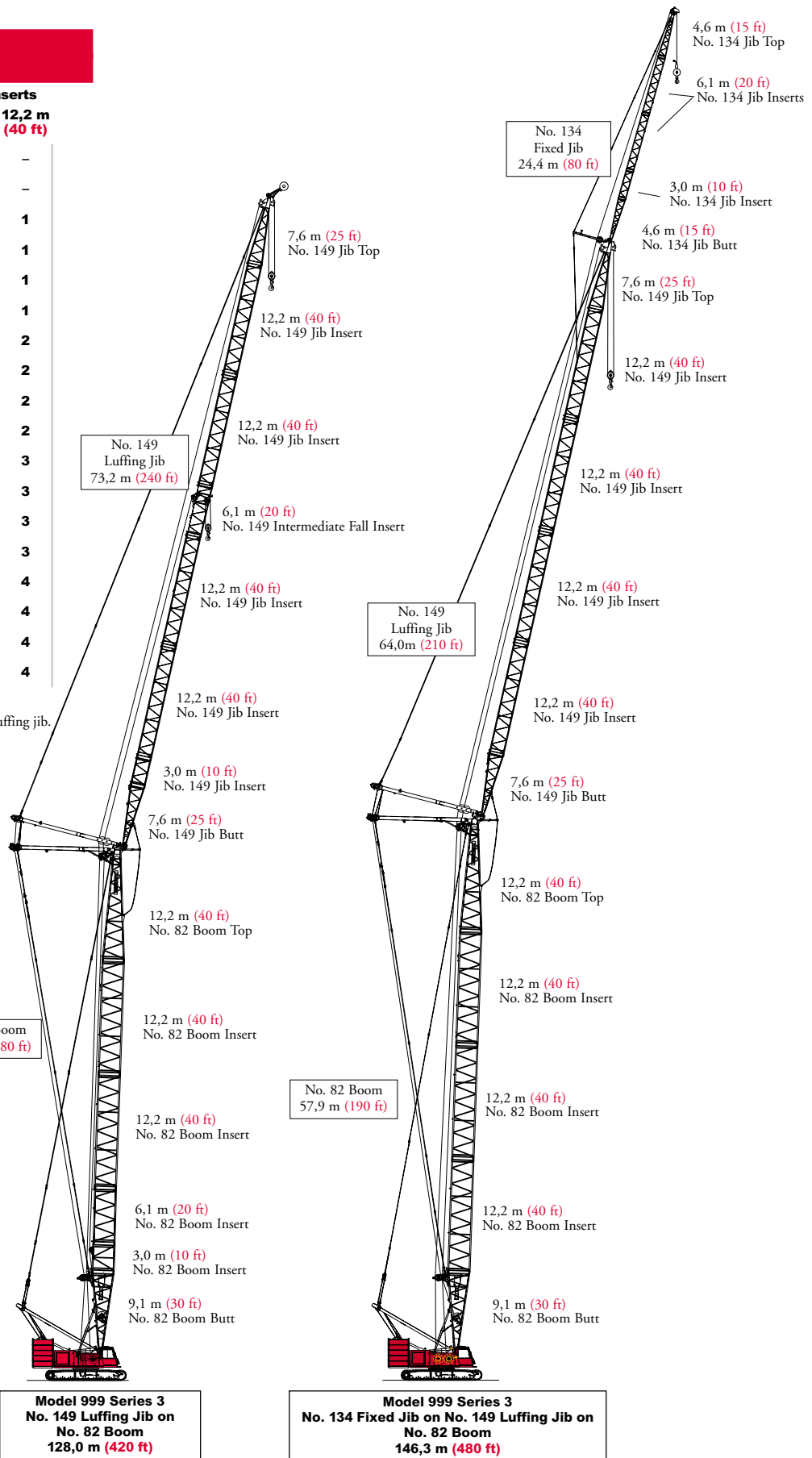

41

heavy-lift boom range diagram

42

No. 82 or No. 22EL Main Boom

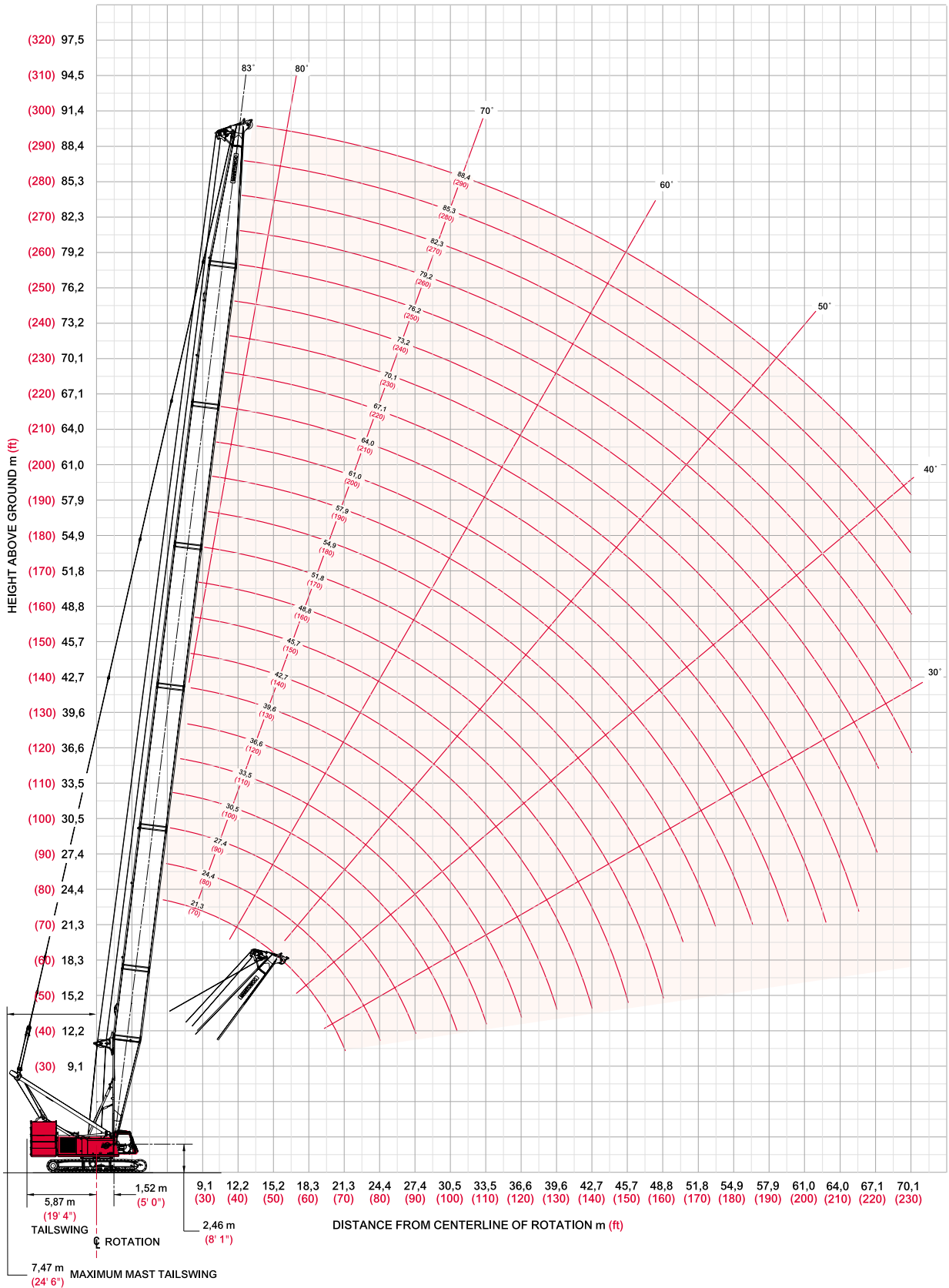

heavy-lift boom load chart

43

Liftcrane Boom Capacities - Series 3 Boom No. 82 or No. 22EL

99 609 kg (219,600 lb) Upperworks Counterweight 36 288 kg (80,000 lb) Carbody Counterweight

360° Rating kg (lb) x 1 000

Boom m (ft)	21,3 (70)	27,4 (90)	33,5 (110)	39,6 (130)	45,7 (150)	51,8 (170)	57,9 (190)	64,0 (210)	70,1 (230)	76,2 (250)	82,3 (270)	88,4 (290)
Radius												
4,6 (15)	250,0* (551.0)*											
5,0 (17)	219,9 (462.5)											
6,0 (20)	183,0 (397.5)	180,7 (396.4)										
8,0 (26)	139,0 (309.3)	138,5 (308.3)	138,1 (307.5)	133,2 (295.0)	120,1 (265.5)							
10,0 (32)	111,5 (252.2)	111,1 (251.2)	110,8 (250.5)	110,5 (249.9)	110,6 (248.9)	100,8 (224.1)	88,6 (196.8)					
11,0 (36)	100,2 (221.8)	100,3 (222.0)	100,4 (222.1)	100,3 (221.9)	99,9 (221.0)	97,6 (215.7)	86,3 (190.5)	76,7 (169.2)	63,1 (139.3)			
12,0 (40)	88,2 (190.3)	88,3 (190.4)	88,3 (190.4)	88,3 (190.4)	88,2 (190.0)	88,3 (189.7)	81,4 (177.0)	74,9 (164.5)	62,8 (138.4)	51,8 (114.1)	- (95.1)	
14,0 (46)	70,9 (156.1)	70,9 (156.2)	70,9 (156.1)	70,9 (156.0)	70,6 (155.5)	70,5 (155.1)	70,3 (154.6)	67,9 (149.6)	62,1 (137.1)	51,2 (113.0)	42,6 (94.1)	35,3 (77.9)
15,0 (50)	64,4 (139.0)	64,4 (139.0)	64,4 (138.9)	64,3 (138.8)	64,1 (138.3)	63,9 (137.9)	63,6 (137.3)	63,6 (136.7)	60,7 (132.5)	50,9 (112.2)	42,3 (93.3)	35,0 (77.2)
18,0 (60)	50,1 (108.2)	50,1 (108.1)	50,0 (108.0)	49,9 (107.8)	49,6 (107.2)	49,5 (106.8)	49,1 (106.1)	48,9 (105.5)	48,6 (104.7)	48,2 (104.7)	41,5 (91.4)	34,3 (75.5)
24,0 (80)		33,6 (72.6)	33,6 (72.5)	33,5 (72.3)	33,2 (71.7)	33,0 (71.2)	32,6 (70.4)	32,3 (69.8)	31,9 (68.9)	31,9 (68.9)	31,5 (68.0)	31,3 (67.2)
30,0 (100)			24,4 (52.7)	24,3 (52.5)	24,1 (51.9)	23,8 (51.4)	23,5 (50.6)	23,1 (49.9)	22,7 (49.0)	22,7 (48.9)	22,3 (48.0)	21,9 (47.2)
34,0 (110)			- (41.6)	20,2 (45.6)	19,9 (45.0)	19,7 (44.4)	19,3 (43.6)	19,0 (42.9)	18,6 (42.0)	18,6 (42.0)	18,1 (41.0)	17,7 (40.2)
36,0 (120)				18,5 (39.8)	18,2 (39.2)	18,0 (38.7)	17,6 (37.9)	17,3 (37.2)	16,9 (36.3)	16,8 (36.2)	16,4 (35.3)	16,0 (34.5)
40,0 (130)				- (30.9)	15,3 (34.5)	15,1 (34.0)	14,8 (33.2)	14,4 (32.4)	14,0 (31.6)	14,0 (31.5)	13,5 (30.5)	13,2 (29.7)
42,0 (140)					13,9 (29.3)	13,9 (29.9)	13,5 (29.1)	13,2 (28.4)	12,8 (27.5)	12,8 (27.4)	12,3 (26.5)	12,0 (25.6)
46,0 (150)					- (22.4)	11,7 (26.4)	11,5 (25.7)	11,1 (24.9)	10,7 (24.0)	10,7 (24.0)	10,2 (23.0)	9,8 (22.1)
50,0 (160)						8,7 (21.4)	9,7 (22.6)	9,4 (21.9)	9,0 (21.0)	8,9 (20.9)	8,5 (20.0)	8,1 (19.1)
52,0 (170)							8,5 (19.1)	8,6 (19.3)	8,2 (18.4)	8,2 (18.3)	7,8 (17.4)	7,4 (16.5)
58,0 (190)								5,8 (13.0)	6,1 (13.6)	6,2 (13.9)	5,8 (12.9)	5,4 (12.1)
64,0 (210)									3,4 (7.6)	4,1 (9.1)	3,9 (8.8)	3,8 (8.5)
70,0 (230)										1,8 (4.1)	1,9 (4.2)	1,8 (4.0)

Fixed Jib No. 134 on Heavy-Lift Boom No. 82 or No. 22EL

Jib Length m (ft)	Deduct from Capacity when fixed jib is attached kg (lb)
9,1 (30)	1 220 (2,700)
12,2 (40)	1 590 (3,500)
15,2 (50)	1 950 (4,300)
18,3 (60)	2 310 (5,100)
21,3 (70)	2 770 (6,100)
24,4 (80)	3 220 (7,100)

*NOTE: Special equipment required.

Meets ANSI B30.5 Requirements - Capacities do not exceed 75% of static tipping load.
NOTICE: This capacity chart is for reference only and must not be used for lifting purposes.

long-reach top range diagram

44

No. 82 Long-Reach Boom

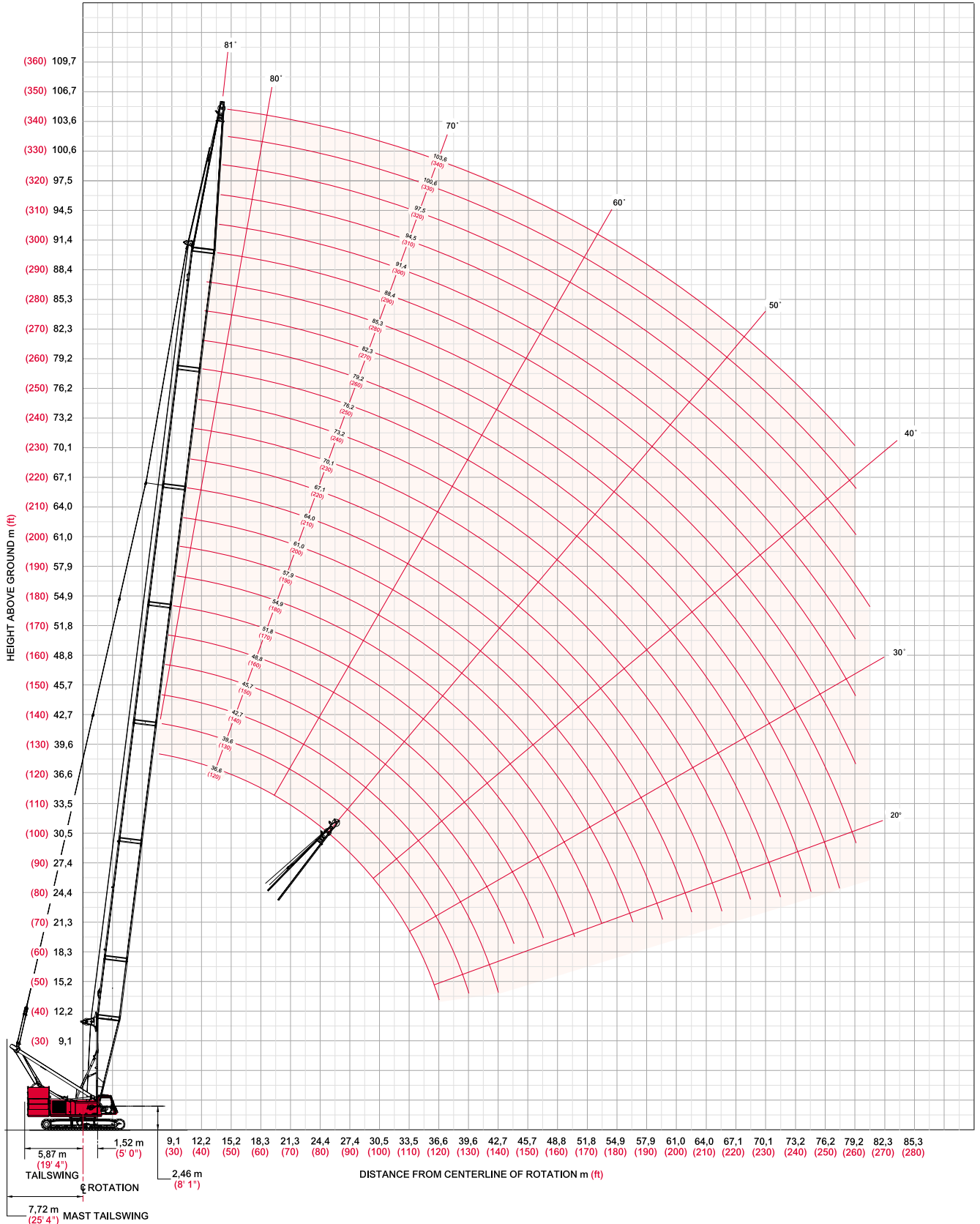

long-reach top load chart

45

Liftcrane Boom Capacities - Series 3

Boom No. 82LR

99 609 kg (219,600 lb) Upperworks Counterweight 36 288 kg (80,000 lb) Carbody Counterweight

360° Rating kg (lb) x 1 000

Boom m (ft)	36,6 (120)	42,7 (140)	48,8 (160)	54,9 (180)	61,0 (200)	67,1 (220)	73,2 (240)	79,2 (260)	85,3 (280)	91,4 (300)	97,5 (320)	103,6 (340)
Radius												
7,3 (24)	120,4 (265.5)											
9,0 (28)	110,2 (252.4)	118,7 (265.5)										
10,0 (30)	102,0 (240.3)	111,3 (260.7)	106,8 (236.0)									
11,0 (34)	94,9 (219.1)	102,0 (238.9)	101,6 (234.8)	93,1 (206.4)								
12,0 (40)	88,4 (192.0)	90,4 (195.0)	90,3 (194.5)	89,5 (194.1)	79,7 (175.4)	- (152.5)						
14,0 (46)	73,0 (160.8)	73,0 (160.7)	72,8 (160.2)	72,5 (159.7)	72,3 (159.1)	68,3 (150.7)	56,5 (124.6)	47,0 (103.7)				
15,0 (50)	66,5 (143.7)	66,4 (143.5)	66,2 (143.0)	66,0 (142.5)	65,7 (141.9)	65,8 (141.2)	56,1 (123.6)	46,7 (102.8)	- (85.6)			
16,0 (55)	61,0 (126.6)	60,9 (126.3)	60,7 (125.8)	60,4 (125.2)	60,2 (124.6)	59,8 (123.9)	55,7 (122.3)	46,3 (101.7)	38,6 (84.7)	- (71.6)	- (65.3)	
18,0 (60)	52,2 (112.9)	52,1 (112.6)	51,8 (112.0)	51,6 (111.5)	51,3 (110.8)	51,0 (110.1)	51,0 (109.3)	45,7 (100.6)	38,0 (83.7)	32,1 (70.7)	29,3 (64.6)	- (55.7)
22,0 (70)	40,2 (92.3)	40,0 (92.0)	39,7 (91.3)	39,5 (90.8)	39,1 (90.0)	38,8 (89.4)	38,4 (88.5)	38,1 (87.8)	36,6 (81.8)	31,0 (68.9)	28,2 (63.1)	24,5 (54.3)
24,0 (80)	35,8 (77.5)	35,7 (77.2)	35,4 (76.6)	35,1 (76.0)	34,8 (75.2)	34,5 (74.5)	34,1 (73.7)	33,8 (72.9)	33,6 (72.0)	30,5 (67.2)	26,5 (57.9)	24,1 (53.0)
30,0 (100)	26,7 (57.8)	26,6 (57.5)	26,3 (56.9)	26,0 (56.3)	25,7 (55.5)	25,3 (54.7)	24,9 (53.9)	24,6 (53.1)	24,1 (52.1)	23,8 (51.3)	22,7 (49.5)	21,0 (45.8)
36,0 (120)	19,9 (41.7)	20,8 (44.9)	20,5 (44.3)	20,2 (43.7)	19,9 (42.9)	19,5 (42.1)	19,1 (41.2)	18,7 (40.4)	18,3 (39.5)	17,9 (38.6)	17,7 (38.1)	17,3 (37.2)
42,0 (140)		15,8 (33.0)	16,4 (35.5)	16,2 (34.9)	15,8 (34.1)	15,5 (33.4)	15,1 (32.5)	14,7 (31.6)	14,2 (30.7)	13,9 (29.8)	13,6 (29.3)	13,2 (28.3)
48,0 (155)			- (28.9)	13,2 (29.9)	12,8 (29.1)	12,5 (28.4)	12,1 (27.5)	11,7 (26.6)	11,3 (25.7)	10,9 (24.8)	10,6 (24.2)	10,2 (23.3)
54,0 (175)				- (22.5)	10,5 (23.8)	10,2 (23.1)	9,8 (22.2)	9,4 (21.4)	9,0 (20.4)	8,6 (19.6)	8,3 (19.0)	7,9 (18.0)
60,0 (195)					- (17.2)	8,3 (18.9)	8,0 (18.1)	7,6 (17.3)	7,2 (16.3)	6,8 (15.4)	6,5 (14.8)	6,1 (13.9)
64,0 (215)						6,4 (12.6)	6,8 (13.7)	6,6 (13.9)	6,2 (13.0)	5,8 (12.1)	5,5 (11.5)	5,1 (10.6)
68,0 (225)							5,2 (11.1)	5,4 (11.6)	5,3 (11.4)	4,9 (10.6)	4,6 (10.0)	4,2 (9.1)
72,0 (240)								4,1 (8.3)	4,1 (8.2)	3,9 (8.0)	3,8 (8.1)	3,4 (7.2)
76,0 (255)								2,7 (4.8)	2,9 (5.3)	2,8 (5.2)	2,9 (5.5)	2,6 (5.0)
78,0 (260)									2,3 (4.4)	2,2 (4.4)	2,4 (4.7)	2,1 (4.1)

Fixed Jib No. 134 on No. 82 Long Reach Top on Boom No. 82

Jib Length m (ft)	Deduct from Capacity when fixed jib is attached kg (lb)
9,1 (30)	1 220 (2,700)
12,2 (40)	1 590 (3,500)
15,2 (50)	1 950 (4,300)
18,3 (60)	2 310 (5,100)
21,3 (70)	2 770 (6,100)
24,4 (80)	3 220 (7,100)

Fixed Jib No. 134 on No. 82 Long Reach Top on Boom No. 82

Jib Length m (ft)	Deduct from Capacity when fixed jib is attached kg (lb)
9,1 (30)	1 130 (2,500)
12,2 (40)	1 410 (3,100)
15,2 (50)	1 680 (3,700)
18,3 (60)	2 000 (4,400)

Meets ANSI B30.5 Requirements - Capacities do not exceed 75% of static tipping load.
NOTICE: This capacity chart is for reference only and must not be used for lifting purposes.

open throat top boom range diagram

PRELIMINARY

46

No. 22E Main Boom with Open Throat Top

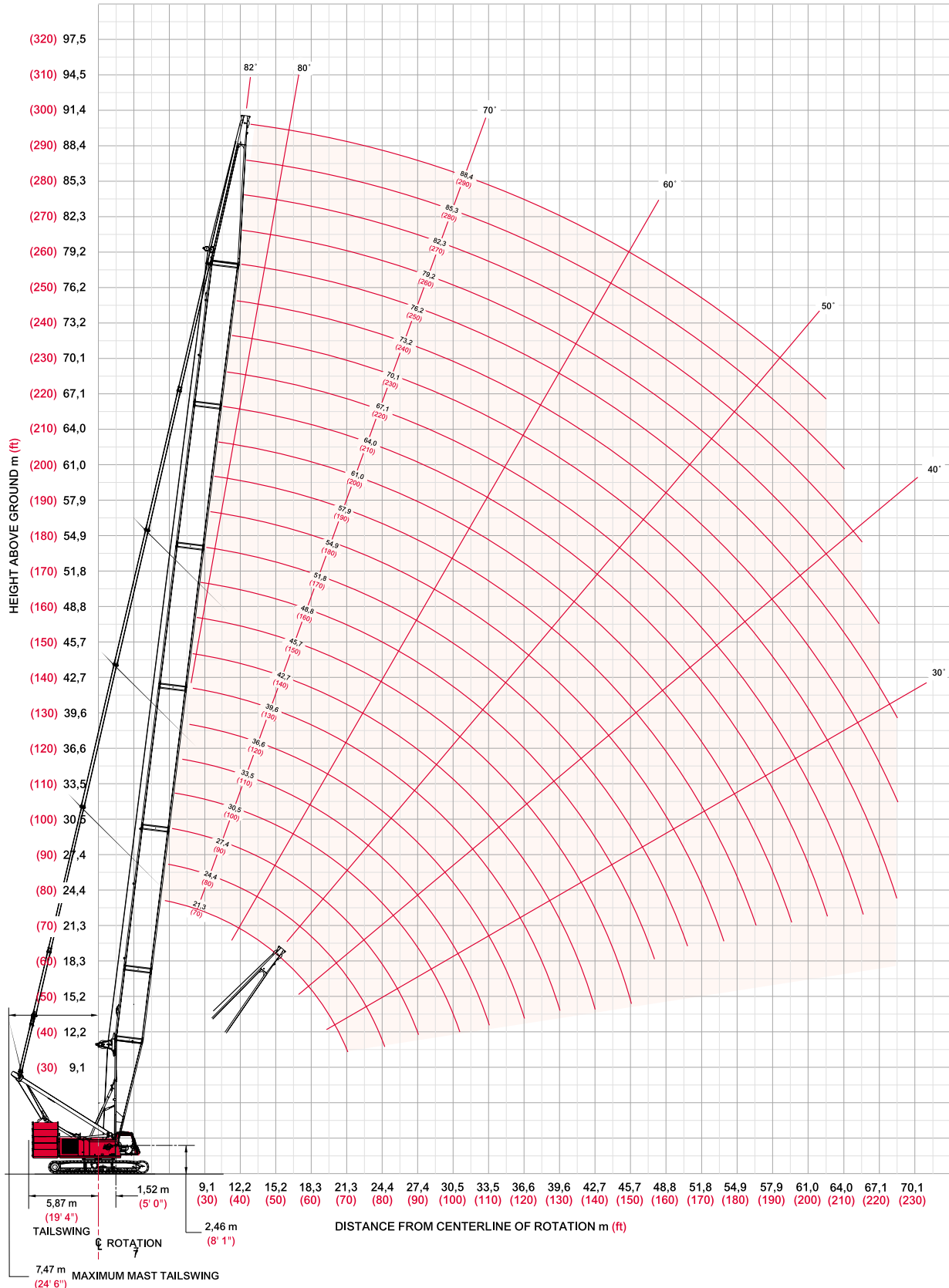

model 999
Manitowoc

open throat top load chart

47

PRELIMINARY

Liftcrane Boom Capacities - Series 3 Boom No. 22E with Open Throat Top

99 609 kg (219,600 lb) Upperworks Counterweight 36 288 kg (80,000 lb) Carbody Counterweight

360° Rating kg (lb) x 1 000

Boom m (ft)	21,3 (70)	27,4 (90)	33,5 (110)	39,6 (130)	45,7 (150)	51,8 (170)	57,9 (190)	64,0 (210)	70,1 (230)	76,2 (250)	82,3 (270)	88,4 (290)
Radius												
4,6 (15)	208,6 (460.0)											
5,5 (18)	176,1 (389.3)	171,4 (378.0)										
6,0 (20)	162,2 (352.4)	162,1 (351.0)										
8,0 (26)	122,8 (273.3)	122,2 (272.0)	121,6 (270.7)	121,4 (269.6)	108,8 (240.5)							
10,0 (32)	95,5 (218.3)	95,5 (218.3)	95,6 (218.3)	95,6 (218.1)	95,3 (217.1)	91,6 (204.5)	81,5 (181.0)					
12,0 (40)	72,8 (157.0)	72,7 (156.8)	72,6 (156.5)	72,5 (156.3)	72,2 (155.6)	71,9 (155.0)	71,9 (154.4)	69,5 (152.6)	60,9 (134.2)	- (110.9)		
15,0 (50)	53,2 (114.8)	53,0 (114.5)	52,9 (114.1)	52,7 (113.7)	52,4 (113.0)	52,1 (112.4)	51,7 (111.6)	51,4 (110.9)	51,1 (110.1)	49,5 (109.0)	41,2 (90.8)	34,2 (75.3)
18,0 (60)	41,4 (89.4)	41,2 (89.1)	41,0 (88.5)	40,8 (88.2)	40,5 (87.4)	40,2 (86.7)	39,8 (85.9)	39,4 (85.1)	39,1 (84.3)	38,8 (83.6)	38,3 (82.7)	33,4 (73.6)
22,0 (70)	- (72.4)	31,3 (72.1)	31,0 (71.5)	30,8 (71.1)	30,5 (70.3)	30,1 (69.6)	29,8 (68.8)	29,4 (68.0)	29,0 (67.1)	28,6 (66.3)	28,3 (65.5)	27,9 (64.6)
24,0 (80)		27,7 (59.9)	27,4 (59.3)	27,3 (58.9)	26,9 (58.1)	26,6 (57.4)	26,2 (56.5)	25,8 (55.7)	25,4 (54.8)	25,1 (54.0)	24,6 (53.1)	24,2 (52.2)
28,0 (90)		- (50.6)	22,0 (50.1)	21,8 (49.7)	21,5 (48.9)	21,1 (48.2)	20,7 (47.3)	20,4 (46.5)	20,0 (45.6)	19,6 (44.8)	19,2 (43.9)	18,8 (43.0)
30,0 (100)			19,9 (42.9)	19,7 (42.6)	19,4 (41.8)	19,0 (41.4)	18,6 (40.2)	18,3 (39.4)	17,8 (38.4)	17,5 (37.6)	17,0 (36.7)	16,7 (35.8)
34,0 (110)			- (37.1)	16,3 (36.8)	15,9 (36.0)	15,6 (35.4)	15,2 (34.4)	14,8 (33.6)	14,4 (32.7)	14,1 (31.9)	13,6 (30.9)	13,2 (30.0)
36,0 (120)				14,9 (32.1)	14,5 (31.3)	14,2 (30.7)	13,8 (29.7)	13,4 (28.9)	13,0 (28.0)	12,6 (27.2)	12,2 (26.2)	11,8 (25.3)
40,0 (130)				- (28.1)	12,2 (27.4)	11,9 (26.7)	11,5 (25.8)	11,1 (25.0)	10,6 (24.0)	10,3 (23.2)	9,8 (22.2)	9,4 (21.3)
42,0 (140)					11,1 (24.0)	10,9 (23.4)	10,5 (22.5)	10,1 (21.7)	9,7 (20.7)	9,3 (19.9)	8,8 (18.9)	8,4 (18.0)
46,0 (150)						9,1 (20.5)	8,7 (19.6)	8,4 (18.8)	8,0 (17.9)	7,6 (17.1)	7,1 (16.0)	6,7 (15.1)
50,0 (160)						7,7 (18.0)	7,3 (17.1)	6,9 (16.4)	6,5 (15.4)	6,2 (14.6)	5,7 (13.6)	5,3 (12.7)
52,0 (170)							6,7 (14.9)	6,3 (14.2)	5,9 (13.2)	5,5 (12.4)	5,1 (11.4)	4,7 (10.5)
58,0 (190)								4,7 (10.5)	4,3 (9.6)	3,9 (8.8)	3,5 (7.8)	3,1 (6.9)
64,0 (210)									2,9 (6.6)	2,6 (5.9)	2,1 (4.8)	
68,0 (225)									2,2 (4.6)	1,9 (4.0)		

Fixed Jib No. 123 on No. 22C Open Throat Top on Boom No. 22E

Jib Length m (ft)	Deduct from Capacity when fixed jib is attached kg (lb)
9,1 (30)	1 130 (2,500)
12,2 (40)	1 410 (3,100)
15,2 (50)	1 680 (3,700)
18,3 (60)	2 000 (4,400)

Meets ANSI B30.5 Requirements - Capacities do not exceed 75% of static tipping load.
NOTICE: This capacity chart is for reference only and must not be used for lifting purposes.



light tapered top range diagram

PRELIMINARY

No. 22E Main Boom with Light Tapered Top

48

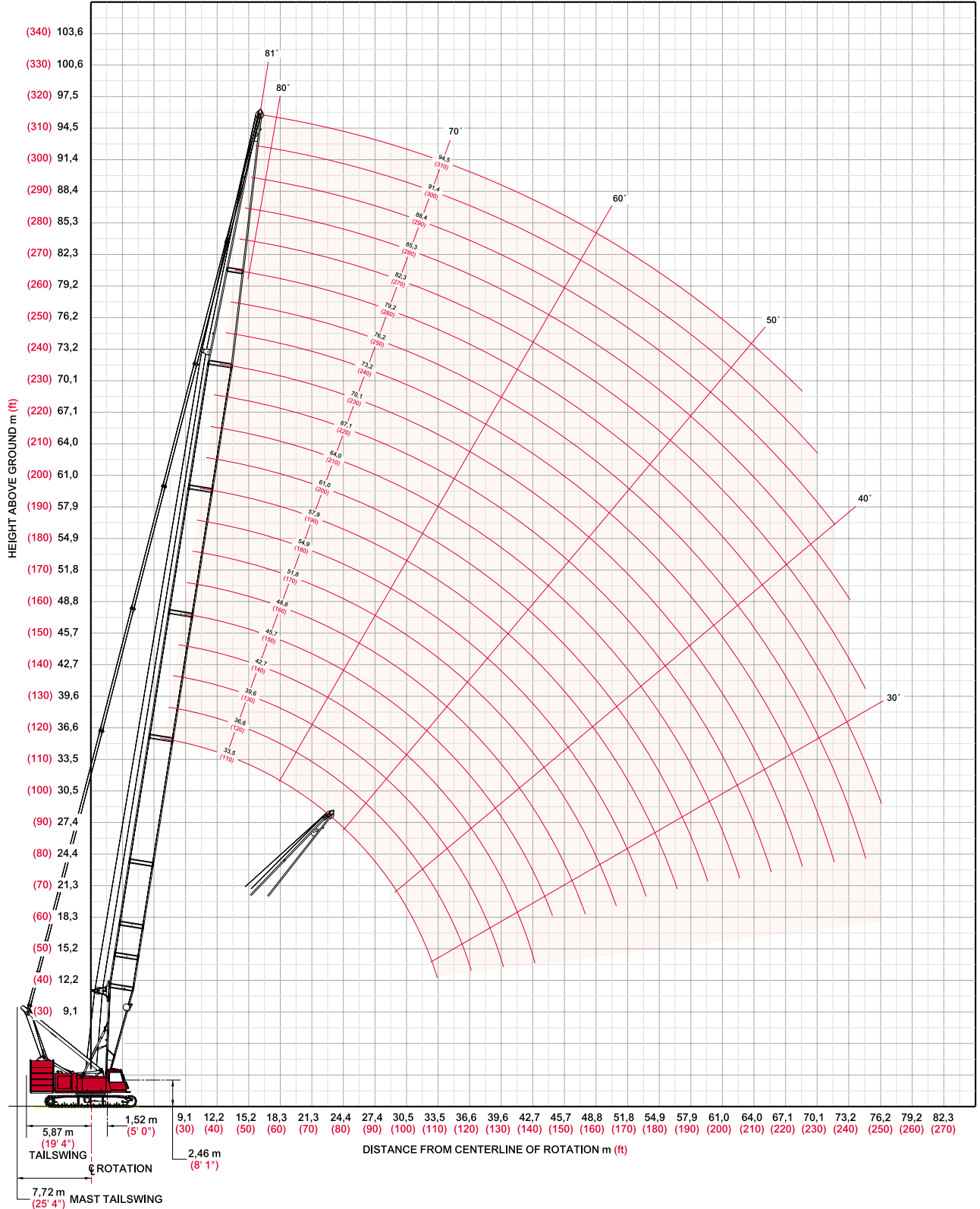

light tapered top load chart

PRELIMINARY

Liftcrane Boom Capacities - Series 2 Boom No. 22E with Light Tapered Top

99 609 kg (219,600 lb) Upperworks Counterweight 36 288 kg (80,000 lb) Carbody Counterweight

360° Rating

kg (lb) x 1 000

Boom m (ft)	33,5 (110)	39,6 (130)	45,7 (150)	51,8 (170)	57,9 (190)	64,0 (210)	70,1 (230)	76,2 (250)	79,2 (260)	82,3 (270)	88,4 (290)	94,5 (310)
----------------	---------------	---------------	---------------	---------------	---------------	---------------	---------------	---------------	---------------	---------------	---------------	---------------

Radius

7,3 (24)	120,4 (265.5)											
8,0 (28)	119,9 (256.4)	119,8 (254.9)										
9,0 (30)	110,7 (239.6)	110,0 (238.0)	103,1 (227.3)									
10,0 (34)	97,0 (202.3)	97,0 (202.1)	97,4 (201.6)	90,8 (198.3)								
12,0 (40)	74,2 (160.0)	74,0 (159.6)	73,7 (159.0)	73,4 (158.4)	73,7 (157.8)	69,5 (152.5)						
14,0 (46)	59,9 (131.8)	59,6 (131.3)	59,3 (130.6)	59,0 (130.0)	58,7 (129.2)	58,4 (128.6)	58,0 (127.8)	49,4 (108.9)	45,3 (100.0)			
15,0 (50)	54,5 (117.7)	54,2 (117.1)	53,9 (116.4)	53,6 (115.7)	53,3 (115.0)	53,0 (114.3)	52,6 (113.4)	49,1 (108.1)	45,0 (99.2)	41,3 (90.9)		
18,0 (60)	42,6 (92.2)	42,3 (91.5)	42,0 (90.8)	41,7 (90.1)	41,3 (89.3)	41,0 (88.6)	40,6 (87.7)	40,4 (87.0)	40,5 (86.5)	39,4 (86.1)	33,8 (74.4)	28,3 (62.3)
22,0 (70)	32,7 (75.3)	32,4 (74.5)	32,0 (73.7)	31,7 (73.0)	31,3 (72.1)	31,0 (71.4)	30,6 (70.5)	30,2 (69.7)	30,0 (69.3)	29,8 (68.9)	29,5 (68.0)	26,1 (58.4)
24,0 (80)	29,2 (63.1)	28,8 (62.3)	28,4 (61.5)	28,1 (60.8)	27,7 (59.9)	27,4 (59.1)	27,0 (58.2)	26,6 (57.4)	26,4 (57.0)	26,2 (56.5)	25,8 (55.6)	25,0 (54.7)
28,0 (90)	23,8 (54.0)	23,4 (53.1)	23,0 (52.3)	22,7 (51.6)	22,3 (50.7)	21,9 (49.9)	21,5 (49.0)	21,1 (48.2)	20,9 (47.7)	20,7 (47.3)	20,3 (46.4)	19,9 (45.4)
32,0 (100)	19,8 (46.8)	19,5 (46.0)	19,0 (45.1)	18,8 (44.5)	18,3 (43.5)	18,0 (42.7)	17,6 (41.8)	17,2 (41.0)	17,0 (40.6)	16,7 (40.1)	16,3 (39.2)	15,9 (38.2)
36,0 (120)		16,4 (35.5)	16,1 (34.7)	15,8 (34.1)	15,4 (33.1)	15,0 (32.3)	14,5 (31.3)	14,2 (30.6)	14,0 (30.1)	13,7 (29.6)	13,3 (28.7)	12,9 (27.7)
42,0 (140)			12,7 (27.4)	12,4 (26.8)	12,0 (25.9)	11,6 (25.0)	11,2 (24.1)	10,8 (23.3)	10,6 (22.8)	10,4 (22.3)	10,0 (21.4)	9,5 (20.4)
48,0 (160)				9,9 (21.4)	9,5 (20.5)	9,2 (19.7)	8,7 (18.8)	8,4 (18.0)	8,2 (17.5)	7,9 (17.0)	7,5 (16.1)	7,0 (15.0)
52,0 (180)					8,2 (16.4)	7,8 (15.6)	7,4 (14.7)	7,1 (13.9)	6,8 (13.4)	6,6 (12.9)	6,2 (12.0)	5,7 (10.9)
56,0 (200)						7,1 (12.3)	6,7 (11.4)	6,3 (10.6)	6,0 (10.2)	5,7 (9.6)	5,1 (8.7)	4,6 (7.7)
60,0 (210)							5,8 (10.0)	5,3 (9.3)	5,0 (8.8)	4,5 (8.2)	4,1 (7.4)	3,6 (6.3)
64,0 (220)								4,5 (8.7)	4,2 (8.0)	3,9 (7.5)	3,7 (6.1)	2,8 (5.1)
70,0 (230)									3,1 (6.8)	2,9 (6.4)	2,6 (5.8)	
74,0 (240)									2,5 (5.8)	2,2 (5.3)	2,0 (4.8)	
76,0 (250)										1,9 (4.3)		

Fixed Jib No. 123 on Light Tapered Top Boom No. 22E

Jib Length m (ft)	Deduct from Capacity when fixed jib is attached kg (lb)
9,1 (30)	1 130 (2,500)
12,2 (40)	1 410 (3,100)
15,2 (50)	1 680 (3,700)
18,3 (60)	2 000 (4,400)

Meets ANSI B30.5 Requirements - Capacities do not exceed 75% of static tipping load.
NOTICE: This capacity chart is for reference only and must not be used for lifting purposes.

fixed jib range diagram

50

No. 134 Fixed Jib on No. 82 or No. 22EL Main Boom

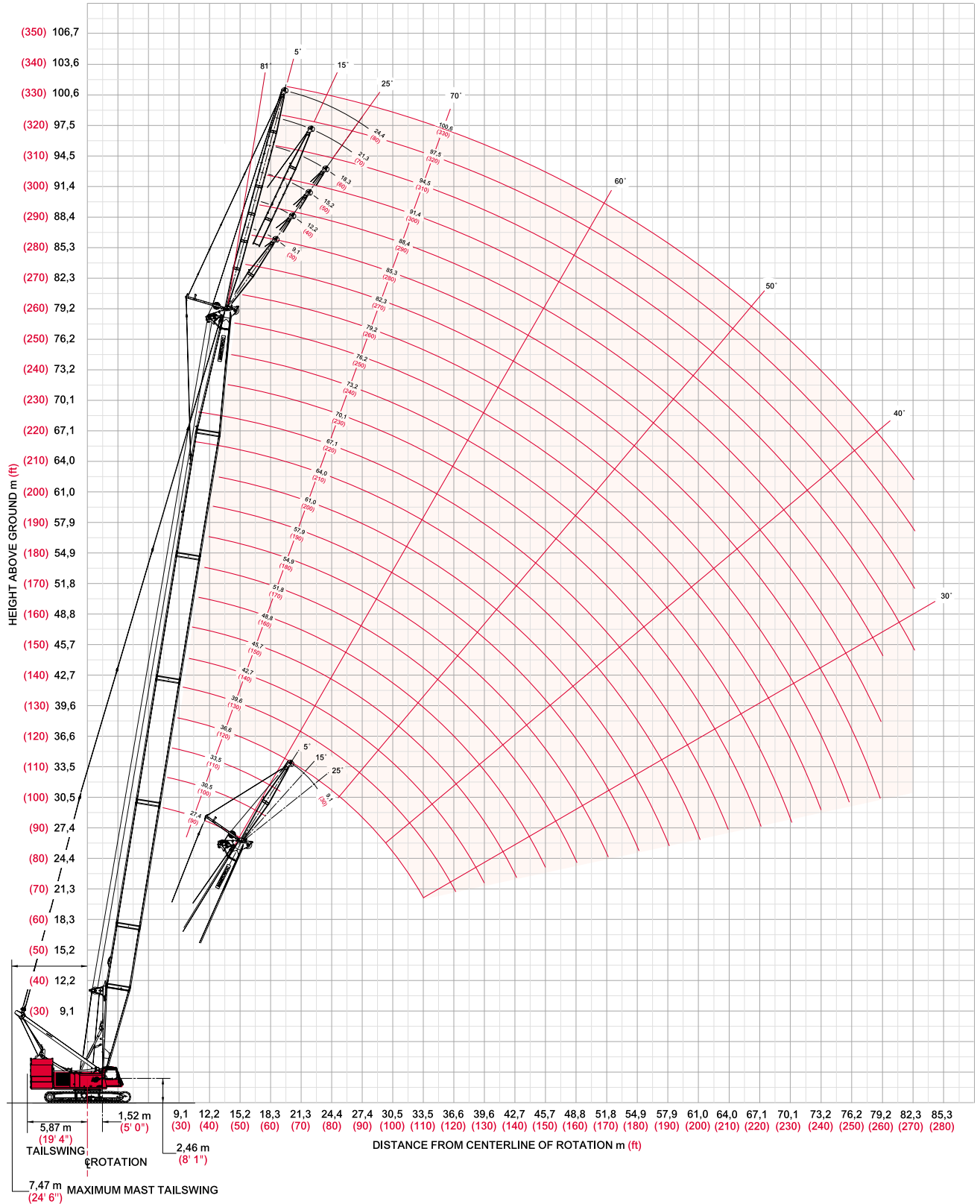

fixed jib load chart

51

Liftcrane Boom Capacities

Fixed Jib No. 134 with 3 810 mm (12' 6") strut on Boom No. 82 or No. 22EL

99 609 kg (219,600 lb) Upperworks Counterweight

36 288 kg (80,000 lb) Carbody

360° Rating

kg (lb) x 1 000

Boom m (ft)	5° Offset					25° Offset				
	27,4 (90)	39,6 (130)	54,9 (180)	70,1 (230)	82,3 (270)	27,4 (90)	39,6 (130)	54,9 (180)	70,1 (230)	82,3 (270)
Radius 9,1 (30)	26,7 (59.0)									
12,0 (40)	26,7 (59.0)	26,7 (59.0)				- (48.9)				
16,0 (50)	26,7 (59.0)	26,7 (59.0)	26,7 (59.0)	26,7 (59.0)		19,3 (43.8)	21,2 (47.8)			
22,0 (70)	25,3 (56.2)	26,6 (59.0)	26,7 (59.0)	26,7 (59.0)	25,3 (56.0)	16,3 (36.7)	18,3 (41.1)	20,1 (45.0)	21,4 (47.9)	22,3 (49.7)
28,0 (90)	23,8 (53.3)	25,4 (56.3)	26,3 (59.0)	26,0 (58.7)	24,4 (54.3)	14,4 (32.2)	16,3 (36.3)	18,1 (40.4)	19,5 (43.5)	20,4 (45.5)
36,0 (120)		19,3 (41.7)	18,4 (39.6)	17,3 (37.3)	16,7 (36.0)		14,4 (31.6)	16,1 (35.4)	17,5 (38.5)	17,6 (37.7)
48,0 (150)		- (28.5)	11,3 (27.3)	10,2 (25.0)	9,6 (23.7)			11,6 (28.1)	10,7 (26.0)	10,2 (24.9)
56,0 (180)			8,2 (19.3)	7,3 (17.0)	6,7 (15.7)				7,6 (17.7)	7,1 (16.6)
64,0 (210)				4,9 (10.9)	4,5 (10.1)					4,8 (10.7)
72,0 (240)					2,2 (4.3)					
80,0 (270)										

Boom m (ft)	5° Offset					25° Offset				
	27,4 (90)	39,6 (130)	54,9 (180)	70,1 (230)	79,2 (260)	27,4 (90)	39,6 (130)	54,9 (180)	70,1 (230)	79,2 (260)
Radius 9,1 (30)										
12,0 (40)	18,9 (41.6)	- (43.3)								
16,0 (50)	17,5 (39.3)	18,5 (41.4)	19,3 (43.1)			14,5 (33.0)				
22,0 (70)	15,9 (35.6)	17,0 (38.0)	18,0 (40.2)	18,7 (41.7)	19,1 (42.5)	11,9 (26.8)	13,1 (29.5)	14,2 (31.9)		
28,0 (90)	14,7 (32.8)	15,9 (35.3)	16,9 (37.7)	17,8 (39.5)	18,1 (40.3)	10,2 (22.8)	11,4 (25.6)	12,6 (28.2)	13,5 (30.2)	13,9 (31.1)
36,0 (120)	12,3 (26.8)	14,6 (32.1)	15,7 (34.6)	16,6 (36.6)	17,1 (37.5)		9,9 (21.6)	11,0 (24.2)	12,0 (26.3)	12,4 (27.3)
48,0 (150)		11,7 (27.1)	11,8 (28.3)	10,7 (25.9)	10,3 (25.1)			9,4 (21.4)	10,3 (23.4)	10,8 (24.5)
56,0 (180)			8,8 (20.3)	7,7 (17.9)	7,3 (17.1)			8,7 (19.5)	8,2 (19.1)	8,0 (18.5)
64,0 (210)			5,8 (13.0)	5,5 (12.2)	5,1 (11.4)				5,9 (13.1)	5,6 (12.5)
72,0 (240)				3,1 (6.2)	3,2 (6.5)					3,8 (7.8)
80,0 (270)										

Meets ANSI B30.5 Requirements - Capacities do not exceed 75% of static tipping load.
 NOTICE: This capacity chart is for reference only and must not be used for lifting purposes.

fixed jib load chart

52

Liftcrane Boom Capacities

Fixed Jib No. 134 with 3 810 mm (12' 6") strut on Boom No. 82 or No. 22EL

99 609 kg (219,600 lb) Upperworks Counterweight

36 288 kg (80,000 lb) Carbody Counterweight

360° Rating

kg (lb) x 1 000

Boom m (ft)	5° Offset					25° Offset				
	27,4 (90)	39,6 (130)	54,9 (180)	70,1 (230)	79,2 (260)	27,4 (90)	39,6 (130)	54,9 (180)	70,1 (230)	79,2 (260)
Radius 9,1 (30)										
12,0 (40)	15,9 (35.0)	- (36.3)								
16,0 (50)	14,8 (33.2)	15,6 (34.8)	16,2 (36.1)							
22,0 (70)	13,4 (30.1)	14,4 (32.1)	15,1 (33.7)	15,7 (34.9)	16,0 (35.5)	10,8 (24.4)	11,3 (25.1)	11,5 (25.7)		
28,0 (90)	12,2 (27.3)	13,3 (29.6)	14,2 (31.7)	14,9 (33.1)	15,2 (33.8)	9,1 (20.4)	10,2 (22.8)	11,1 (24.6)	11,3 (25.1)	11,4 (25.4)
36,0 (120)	10,8 (23.4)	12,1 (26.5)	13,1 (28.8)	13,9 (30.6)	14,3 (31.5)	7,6 (16.6)	8,6 (18.9)	9,6 (21.1)	10,4 (22.9)	10,9 (23.9)
48,0 (150)		10,0 (23.3)	11,7 (26.5)	10,8 (26.2)	10,4 (25.4)		7,2 (16.3)	8,1 (18.4)	8,9 (20.2)	9,3 (21.2)
56,0 (180)		8,5 (19.3)	9,0 (20.7)	7,8 (18.2)	7,5 (17.3)			7,4 (16.5)	8,1 (18.2)	8,3 (19.1)
64,0 (210)			6,4 (14.3)	5,6 (12.5)	5,3 (11.7)				6,2 (13.7)	5,9 (13.1)
72,0 (240)				3,5 (7.1)	3,5 (7.2)					4,0 (8.5)
80,0 (270)										

Boom m (ft)	5° Offset					25° Offset				
	27,4 (90)	39,6 (130)	54,9 (180)	70,1 (230)	76,2 (250)	27,4 (90)	39,6 (130)	54,9 (180)	70,1 (230)	76,2 (250)
Radius 9,1 (30)										
12,0 (40)	- (20.6)									
16,0 (50)	9,1 (20.3)	9,3 (20.6)	9,4 (20.8)							
22,0 (70)	8,9 (19.7)	9,0 (20.0)	9,1 (20.3)	9,3 (20.6)	9,3 (20.6)	7,7 (17.3)	7,9 (17.7)			
28,0 (90)	8,1 (18.1)	8,8 (19.6)	9,0 (19.9)	9,1 (20.2)	9,1 (20.3)	7,1 (15.8)	7,4 (16.5)	7,7 (17.1)	7,9 (17.6)	7,9 (17.7)
36,0 (120)	7,1 (15.7)	7,9 (17.4)	8,6 (19.0)	8,9 (19.7)	8,9 (19.8)	5,9 (12.9)	6,7 (14.6)	7,2 (15.8)	7,4 (16.4)	7,5 (16.5)
48,0 (150)	6,0 (13.7)	6,8 (15.5)	7,6 (17.2)	8,2 (18.5)	8,4 (19.0)	- (10.7)	5,3 (12.3)	6,0 (14.0)	6,7 (15.3)	6,9 (15.5)
56,0 (180)		6,2 (13.9)	7,0 (15.6)	7,6 (17.1)	7,8 (17.6)		- (10.7)	5,4 (12.2)	6,0 (13.6)	6,2 (14.1)
64,0 (210)			6,4 (14.3)	5,8 (13.0)	5,7 (12.6)			4,9 (11.0)	5,5 (12.2)	5,7 (12.7)
72,0 (240)			4,5 (9.3)	4,1 (8.6)	4,0 (8.4)				4,7 (10.0)	4,6 (9.8)
80,0 (270)				2,0 (-)	2,1 (-)					3,0 (5.4)

model 999



Meets ANSI B30.5 Requirements - Capacities do not exceed 75% of static tipping load.
 NOTICE: This capacity chart is for reference only and must not be used for lifting purposes.

fixed jib range diagram

No. 123 Fixed Jib on No. 82LR Boom

53

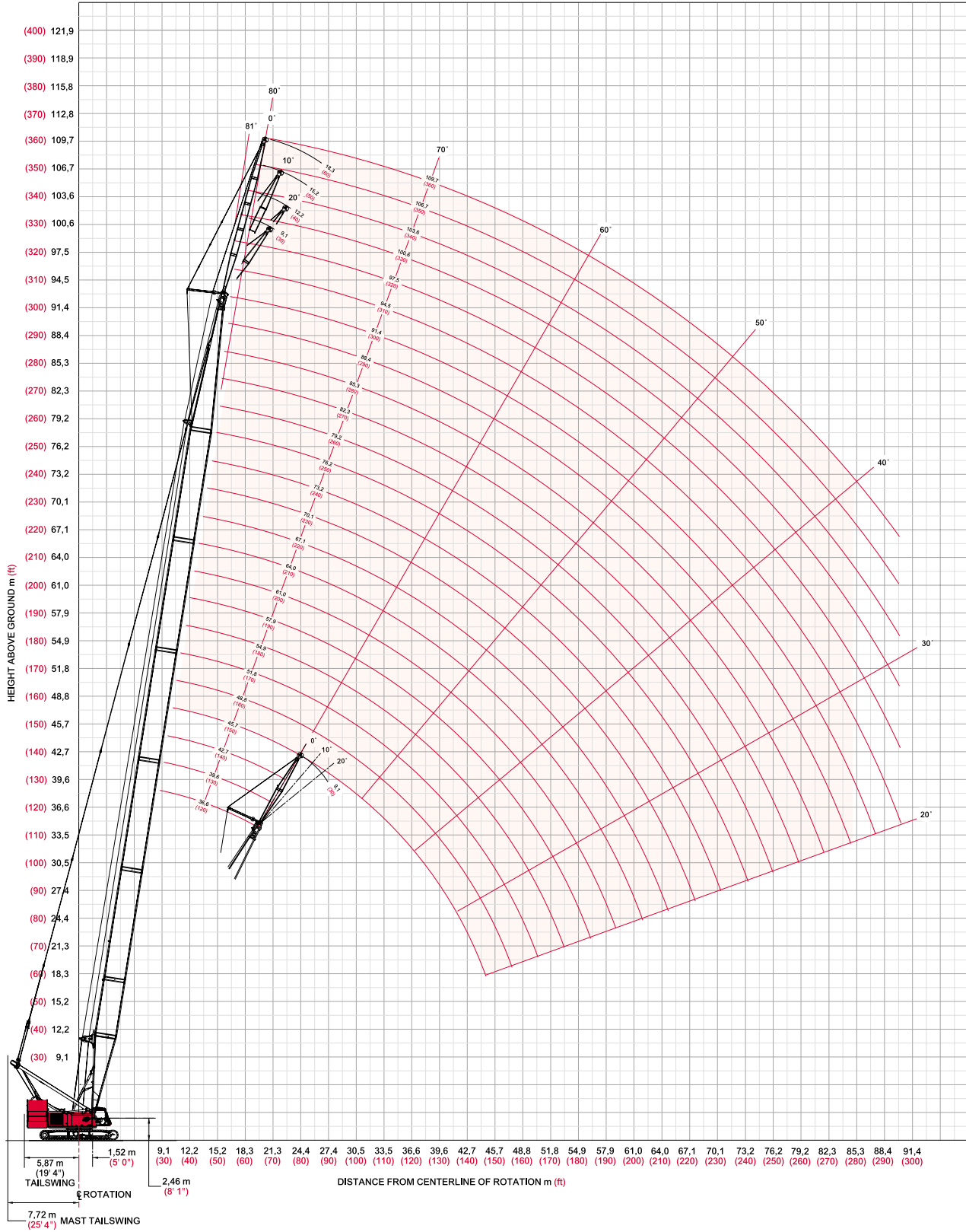

model 999



fixed jib load chart

54

Liftcrane Boom Capacities

Jib No. 123 with 3 810 mm (12' 6") strut on Boom No. 82LR

99 609 kg (219,600 lb) Upperworks Counterweight 36 288 kg (80,000 lb) Carbody Counterweight

360° Rating

kg (lb) x 1 000

Boom m (ft)	0° Offset					20° Offset				
	36,6 (120)	51,8 (170)	67,1 (220)	82,3 (270)	91,4 (300)	36,6 (120)	51,8 (170)	67,1 (220)	82,3 (270)	91,4 (300)
Radius										
10,7 (35)	18,1 (40.0)									
12,0 (40)	18,1 (40.0)	- (40.0)								
16,0 (60)	18,1 (40.0)	18,1 (40.0)	18,1 (40.0)	- (40.0)	- (40.0)	18,1 (40.0)	18,1 (40.0)	- (40.0)		
22,0 (80)	18,1 (40.0)	18,1 (40.0)	18,1 (40.0)	18,1 (40.0)	18,1 (40.0)	18,1 (40.0)	18,1 (40.0)	18,1 (40.0)	18,1 (40.0)	16,9 (37.1)
28,0 (100)	18,1 (40.0)	18,1 (40.0)	18,1 (40.0)	18,1 (40.0)	18,1 (40.0)	16,7 (35.1)	18,1 (40.0)	18,1 (40.0)	18,1 (40.0)	16,6 (36.3)
36,0 (120)	18,1 (40.0)	18,1 (40.0)	18,1 (40.0)	18,1 (40.0)	17,8 (38.8)	14,4 (31.7)	16,7 (36.5)	18,1 (40.0)	18,1 (40.0)	16,1 (35.4)
48,0 (150)		13,5 (32.2)	12,6 (30.2)	11,6 (28.0)	11,0 (26.5)		13,7 (32.3)	12,9 (30.9)	12,0 (28.9)	11,4 (27.6)
56,0 (180)		10,6 (24.2)	9,7 (22.2)	8,7 (20.0)	8,0 (18.6)			9,9 (22.7)	9,0 (20.7)	8,4 (19.4)
68,0 (210)			6,4 (16.7)	5,6 (14.4)	5,0 (13.0)				5,8 (14.9)	5,2 (13.6)
76,0 (240)			- (10.2)	3,8 (10.3)	3,4 (8.8)				- (10.6)	3,7 (9.3)
80,0 (270)				2,8 (5.0)	2,4 (4.3)					2,7 (-)

Boom m (ft)	0° Offset					20° Offset				
	36,6 (120)	51,8 (170)	67,1 (220)	82,3 (270)	91,4 (300)	36,6 (120)	51,8 (170)	67,1 (220)	82,3 (270)	91,4 (300)
Radius										
10,7 (35)	13,6 (30.0)									
16,0 (50)	13,6 (30.0)	13,6 (30.0)	13,6 (30.0)			13,6 (30.0)				
22,0 (70)	13,6 (30.0)	13,6 (30.0)	13,6 (30.0)	13,6 (30.0)	13,6 (30.0)	13,6 (30.0)	13,6 (30.0)	13,6 (30.0)	13,6 (30.0)	
28,0 (100)	13,6 (30.0)	13,6 (30.0)	13,6 (30.0)	13,6 (30.0)	13,6 (30.0)	12,6 (26.4)	13,6 (30.0)	13,6 (30.0)	13,6 (30.0)	13,6 (30.0)
36,0 (130)	13,6 (29.5)	13,6 (30.0)	13,6 (30.0)	13,6 (30.0)	13,6 (30.0)	10,8 (22.6)	12,4 (25.9)	13,6 (28.7)	13,6 (30.0)	13,6 (30.0)
40,0 (160)	13,2 (-)	13,6 (29.5)	13,6 (27.4)	13,6 (25.2)	13,6 (23.8)	10,2 (-)	11,6 (23.0)	12,9 (25.6)	13,6 (26.3)	13,6 (25.1)
48,0 (190)		13,4 (22.4)	12,7 (20.4)	11,7 (18.2)	11,1 (16.7)		10,5 (-)	11,7 (21.0)	12,2 (19.0)	11,7 (17.7)
56,0 (220)		10,7 (-)	9,8 (15.4)	8,8 (13.1)	8,1 (11.7)			10,1 (-)	9,2 (13.7)	8,6 (12.4)
68,0 (240)			6,7 (11.4)	5,7 (10.5)	5,1 (9.0)				6,0 (11.0)	5,4 (9.7)
76,0 (260)			4,2 (-)	4,1 (7.4)	3,6 (6.4)				4,4 (-)	3,8 (7.3)
84,0 (280)				2,1 (4.1)						

Meets ANSI B30.5 Requirements - Capacities do not exceed 75% of static tipping load.
 NOTICE: This capacity chart is for reference only and must not be used for lifting purposes.

fixed jib load chart

55

Liftcrane Boom Capacities

Jib No. 123 with 3 810 mm (12' 6") strut on Boom No. 82LR

99 609 kg (219,600 lb) Upperworks Counterweight 36 288 kg (80,000 lb) Carbody Counterweight

360° Rating

kg (lb) x 1 000

Boom m (ft)	0° Offset					20° Offset				
	36,6 (120)	51,8 (170)	67,1 (220)	82,3 (270)	91,4 (300)	36,6 (120)	51,8 (170)	67,1 (220)	82,3 (270)	91,4 (300)
Radius										
12,2 (40)	9,0 (20.0)									
18,0 (50)	9,0 (20.0)	9,0 (20.0)	9,0 (20.0)			9,0 (20.0)				
24,0 (70)	9,0 (20.0)	9,0 (20.0)	9,0 (20.0)	9,0 (20.0)	9,0 (20.0)	9,0 (20.0)	9,0 (20.0)	9,0 (20.0)		
32,0 (100)	9,0 (20.0)	9,0 (20.0)	9,0 (20.0)	9,0 (20.0)	9,0 (20.0)	9,0 (20.0)	9,0 (20.0)	9,0 (20.0)	9,0 (20.0)	9,0 (20.0)
36,0 (130)	9,0 (20.0)	9,0 (20.0)	9,0 (20.0)	9,0 (20.0)	9,0 (20.0)	8,9 (18.7)	9,0 (20.0)	9,0 (20.0)	9,0 (20.0)	9,0 (20.0)
44,0 (160)	9,0 (20.0)	9,0 (20.0)	9,0 (20.0)	9,0 (20.0)	9,0 (20.0)	7,9 (18.9)	9,0 (20.0)	9,0 (20.0)	9,0 (20.0)	9,0 (20.0)
52,0 (190)		9,0 (20.0)	9,0 (20.0)	9,0 (18.4)	9,0 (17.0)		8,2 (18.9)	9,0 (19.0)	9,0 (19.5)	9,0 (18.2)
60,0 (220)		9,0 (20.0)	8,8 (15.6)	7,7 (13.4)	7,1 (11.9)			8,4 (16.1)	8,2 (14.2)	7,6 (12.9)
68,0 (240)			6,8 (12.5)	5,8 (10.7)	5,1 (9.3)			7,1 (11.4)	6,2 (11.4)	5,1 (10.1)
80,0 (270)				3,4 (6.5)	3,0 (5.5)				3,9 (6.6)	3,3 (6.6)
84,0 (280)				2,5 (4.9)	2,0 (4.0)					2,5 (5.0)

Boom m (ft)	0° Offset					20° Offset				
	36,6 (120)	51,8 (170)	67,1 (220)	82,3 (270)	91,4 (300)	36,6 (120)	51,8 (170)	67,1 (220)	82,3 (270)	91,4 (300)
Radius										
12,2 (40)	4,5 (10.0)									
18,0 (50)	4,5 (10.0)	4,5 (10.0)	4,5 (10.0)							
24,0 (70)	4,5 (10.0)	4,5 (10.0)	4,5 (10.0)	4,5 (10.0)	4,5 (10.0)	4,5 (10.0)	4,5 (10.0)	4,5 (10.0)		
32,0 (100)	4,5 (10.0)	4,5 (10.0)	4,5 (10.0)	4,5 (10.0)	4,5 (10.0)	4,5 (10.0)	4,5 (10.0)	4,5 (10.0)	4,5 (10.0)	4,5 (10.0)
36,0 (130)	4,5 (10.0)	4,5 (10.0)	4,5 (10.0)	4,5 (10.0)	4,5 (10.0)	4,5 (10.0)	4,5 (10.0)	4,5 (10.0)	4,5 (10.0)	4,5 (10.0)
44,0 (160)	4,5 (10.0)	4,5 (10.0)	4,5 (10.0)	4,5 (10.0)	4,5 (10.0)	4,5 (10.0)	4,5 (10.0)	4,5 (10.0)	4,5 (10.0)	4,5 (10.0)
52,0 (190)	4,5 (10.0)	4,5 (10.0)	4,5 (10.0)	4,5 (10.0)	4,5 (10.0)		4,5 (10.0)	4,5 (10.0)	4,5 (10.0)	4,5 (10.0)
60,0 (220)		4,5 (10.0)	4,5 (10.0)	4,5 (10.0)	4,5 (10.0)			4,5 (10.0)	4,5 (10.0)	4,5 (10.0)
68,0 (240)		4,5 (10.0)	4,5 (10.0)	4,5 (10.0)	4,5 (9.4)			4,5 (10.0)	4,5 (10.0)	4,5 (10.0)
80,0 (260)			4,0 (9.3)	3,7 (8.6)	3,1 (7.1)				4,0 (9.3)	3,5 (8.0)
88,0 (280)				1,8 (5.4)	- (4.4)					1,9 (5.7)
- (290)					- (4.0)					- (4.2)

Meets ANSI B30.5 Requirements - Capacities do not exceed 75% of static tipping load.
 NOTICE: This capacity chart is for reference only and must not be used for lifting purposes.

fixed jib range diagram

56

No. 134 Fixed Jib on No. 82LR Boom

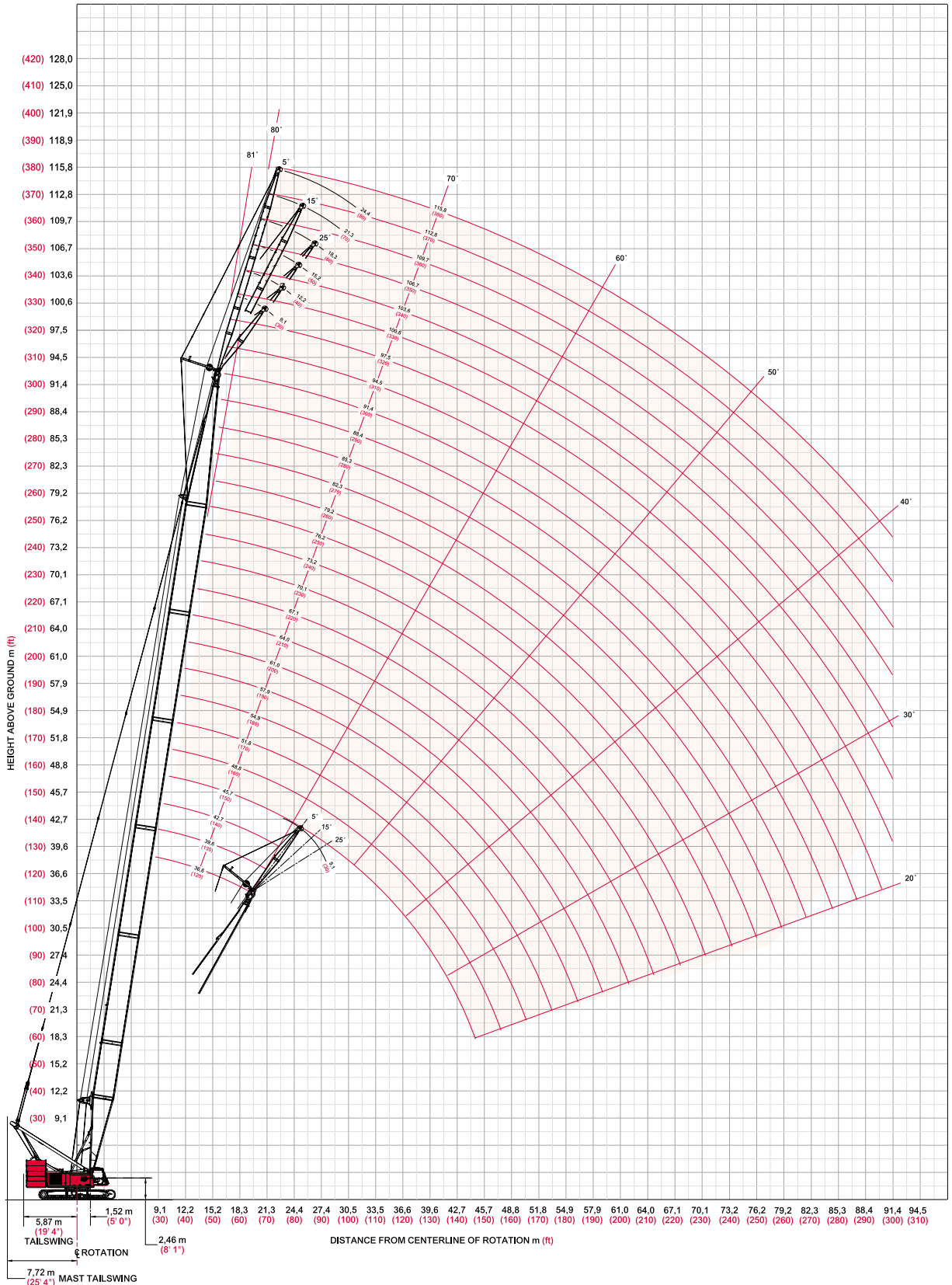

model 999



fixed jib load chart

57

Liftcrane Boom Capacities

Fixed Jib No. 134 with 3 810 mm (12' 6") strut on Boom No. 82LR

99 609 kg (219,600 lb) Upperworks Counterweight 36 288 kg (80,000 lb) Carbody Counterweight

360° Rating

kg (lb) x 1 000

Boom m (ft)	5° Offset					25° Offset				
	36,6 (120)	51,8 (170)	67,1 (220)	82,3 (270)	91,4 (300)	36,6 (120)	51,8 (170)	67,1 (220)	82,3 (270)	91,4 (300)
Radius										
10,7 (35)	26,7 (59.0)									
14,0 (40)	26,7 (59.0)	26,7 (59.0)				20,4 -				
20,0 (50)	26,1 (59.0)	26,7 (59.0)	26,7 (59.0)	26,2 -	20,3 -	17,6 (43.6)	19,2 (46.6)	20,3 -		
26,0 (70)	24,6 (56.8)	26,0 (59.0)	26,7 (59.0)	25,5 (57.6)	19,6 (44.5)	15,5 (37.7)	17,2 (41.3)	18,5 (43.8)	19,3 (42.8)	15,6 -
32,0 (100)	22,2 (51.4)	24,1 (55.5)	23,2 (55.0)	22,3 (52.9)	18,9 (42.1)	14,1 (31.9)	15,7 (35.5)	17,0 (38.4)	18,0 (40.6)	15,4 (34.2)
40,0 (130)	18,1 (40.3)	17,6 (39.5)	16,7 (37.5)	15,7 (35.3)	15,1 (33.9)		14,2 (31.6)	15,5 (34.4)	16,3 (36.5)	15,0 (33.2)
48,0 (160)		13,4 (28.9)	12,5 (26.9)	11,5 (24.7)	10,9 (23.3)			12,8 (27.6)	11,9 (25.6)	11,3 (24.3)
56,0 (190)		- (20.9)	9,5 (19.9)	8,5 (17.6)	7,9 (16.2)			9,7 (20.3)	8,8 (18.3)	8,2 (17.0)
68,0 (220)			6,1 (14.4)	5,5 (12.6)	4,8 (11.1)				5,6 (13.0)	5,0 (11.7)
76,0 (250)				3,6 (7.8)	3,1 (6.9)					3,5 (7.7)
80,0 (270)				2,5 (4.4)	2,1 -					

Boom m (ft)	5° Offset					25° Offset				
	36,6 (120)	51,8 (170)	67,1 (220)	82,3 (270)	91,4 (300)	36,6 (120)	51,8 (170)	67,1 (220)	82,3 (270)	91,4 (300)
Radius										
12,2 (40)	18,9 (41.7)									
16,0 (50)	17,8 (39.7)	18,6 (41.4)								
20,0 (60)	16,8 (38.0)	17,7 (39.9)	18,4 (41.3)	18,9 -		12,1 (26.7)	13,2 -			
26,0 (90)	15,6 (33.9)	16,6 (36.2)	17,4 (37.9)	17,9 (39.2)	16,6 (36.5)	11,0 (23.6)	11,9 (25.6)	12,5 (27.2)	11,7 (25.8)	10,2 (22.5)
32,0 (120)	14,6 (30.9)	15,7 (33.3)	16,5 (35.2)	17,1 (36.7)	16,1 (34.8)	9,8 (20.4)	10,8 (22.5)	11,5 (24.2)	11,7 (25.5)	10,2 (22.5)
40,0 (150)	13,1 (25.4)	14,6 (31.0)	15,5 (30.5)	16,1 (28.4)	15,3 (27.0)	8,8 -	9,7 (20.3)	10,5 (21.9)	11,1 (23.3)	10,2 (22.5)
48,0 (180)	10,9 -	13,7 (24.5)	12,8 (22.5)	11,8 (20.3)	11,1 (18.9)		9,0 -	9,7 (20.2)	10,3 (21.5)	10,2 (20.4)
56,0 (210)		10,7 (17.6)	9,8 (16.8)	8,8 (14.6)	8,2 (13.2)			9,0 (17.5)	9,4 (15.6)	8,8 (14.4)
68,0 (240)			6,7 (11.9)	5,7 (10.4)	5,0 (9.0)				6,1 (11.1)	5,5 (9.9)
76,0 (260)			4,5 -	4,2 (7.5)	3,5 (6.5)					3,9 (7.4)
84,0 (280)				2,2 (4.3)						

Meets ANSI B30.5 Requirements - Capacities do not exceed 75% of static tipping load.
 NOTICE: This capacity chart is for reference only and must not be used for lifting purposes.

fixed jib load chart

58

Liftcrane Boom Capacities

Fixed Jib No. 134 with 3 810 mm (12' 6") strut on Boom No. 82LR

99 609 kg (219,600 lb) Upperworks Counterweight 36 288 kg (80,000 lb) Carbody Counterweight

360° Rating

kg (lb) x 1 000

Boom m (ft)	5° Offset					25° Offset				
	36,6 (120)	51,8 (170)	67,1 (220)	82,3 (270)	91,5 (300)	36,6 (120)	51,8 (170)	67,1 (220)	82,3 (270)	91,5 (300)
Radius										
12,2 (40)	14,4 (31.9)									
16,0 (50)	13,6 (30.5)	14,2 (31.7)								
20,0 (60)	12,9 (29.2)	13,5 (30.5)	14,0 (31.5)	14,4 -		9,0 -				
26,0 (90)	11,9 (25.9)	12,7 (27.6)	13,2 (28.9)	13,7 (29.9)	13,9 (30.4)	9,0 (20.0)	10,1 (22.3)	10,3 (22.8)	- (21.1)	- (18.8)
32,0 (120)	11,0 (23.2)	11,9 (25.2)	12,6 (26.7)	13,0 (27.9)	13,3 (28.5)	8,7 (17.6)	9,6 (19.7)	10,3 (21.4)	9,5 (21.1)	8,5 (18.8)
40,0 (150)	10,1 (21.2)	11,0 (23.2)	11,7 (24.8)	12,3 (26.1)	12,6 (26.8)	7,5 (15.3)	8,4 (17.3)	9,2 (18.9)	9,5 (20.3)	8,5 (18.8)
48,0 (180)	9,3 -	10,3 (21.5)	11,0 (22.7)	11,6 (20.5)	11,2 (19.1)		7,5 (15.6)	8,3 (17.1)	9,0 (18.5)	8,5 (18.8)
56,0 (210)		9,6 (18.9)	9,9 (17.0)	8,9 (14.8)	8,2 (13.4)		7,0 -	7,6 (15.7)	8,2 (16.0)	8,5 (14.8)
68,0 (240)			6,8 (12.7)	5,8 (10.6)	5,1 (9.1)			6,9 -	6,3 (11.5)	5,7 (10.2)
76,0 (270)			4,9 (6.8)	4,2 (6.5)	3,6 (5.4)				4,6 -	4,1 (6.7)
84,0 (280)				2,5 (4.9)						2,7 (5.3)

Boom m (ft)	5° Offset					25° Offset				
	36,6 (120)	51,8 (170)	70,1 (230)	82,3 (270)	91,5 (300)	36,6 (120)	51,8 (170)	70,1 (230)	82,3 (270)	91,5 (300)
Radius										
13,7 (45)	9,2 (20.5)									
20,0 (60)	9,0 (20.1)	9,1 (20.3)	9,2 (20.6)							
26,0 (80)	8,5 (19.3)	8,9 (19.9)	9,1 (20.2)	9,2 (20.4)	9,2 (20.4)	5,8 (12.9)	6,5 (14.5)			
32,0 (100)	7,8 (17.7)	8,5 (19.2)	8,9 (19.9)	9,0 (20.0)	9,1 (20.1)	5,8 (12.9)	6,5 (14.5)	6,8 (15.2)	6,6 (14.7)	6,2 (13.8)
40,0 (130)	7,0 (15.6)	7,8 (17.3)	8,4 (18.7)	8,8 (19.5)	8,9 (19.7)	5,7 (12.8)	6,5 (14.4)	6,8 (15.1)	6,6 (14.7)	6,2 (13.8)
48,0 (150)	6,3 (14.4)	7,1 (16.1)	7,8 (17.7)	8,2 (18.5)	8,5 (19.1)	5,0 (11.5)	5,7 (13.1)	6,4 (14.5)	6,6 (14.7)	6,2 (13.8)
56,0 (180)	5,7 (12.9)	6,5 (14.6)	7,3 (16.3)	7,7 (17.2)	8,0 (17.8)		5,1 (11.5)	5,7 (13.0)	6,1 (13.8)	6,2 (13.8)
64,0 (210)		6,0 (13.4)	6,8 (15.1)	6,8 (15.2)	6,2 (13.7)		4,7 (10.4)	5,3 (11.7)	5,6 (12.5)	5,9 (13.1)
72,0 (240)		5,6 (12.4)	6,0 (12.8)	5,1 (11.0)	4,5 (9.5)			4,9 (10.8)	5,2 (11.5)	5,2 (11.0)
80,0 (260)			4,5 (10.4)	3,8 (8.7)	3,1 (7.3)				4,2 (9.7)	3,7 (8.5)
84,0 (280)			3,5 (7.1)	3,0 (6.1)	2,5 (4.9)				3,6 (7.6)	3,1 (6.4)
88,0 (300)			2,6 (4.0)	2,2 -						2,4 -

Meets ANSI B30.5 Requirements - Capacities do not exceed 75% of static tipping load.
 NOTICE: This capacity chart is for reference only and must not be used for lifting purposes.

fixed jib range diagram

PRELIMINARY

No. 123 Fixed Jib on No. 22E Main Boom with Open Throat Top

59

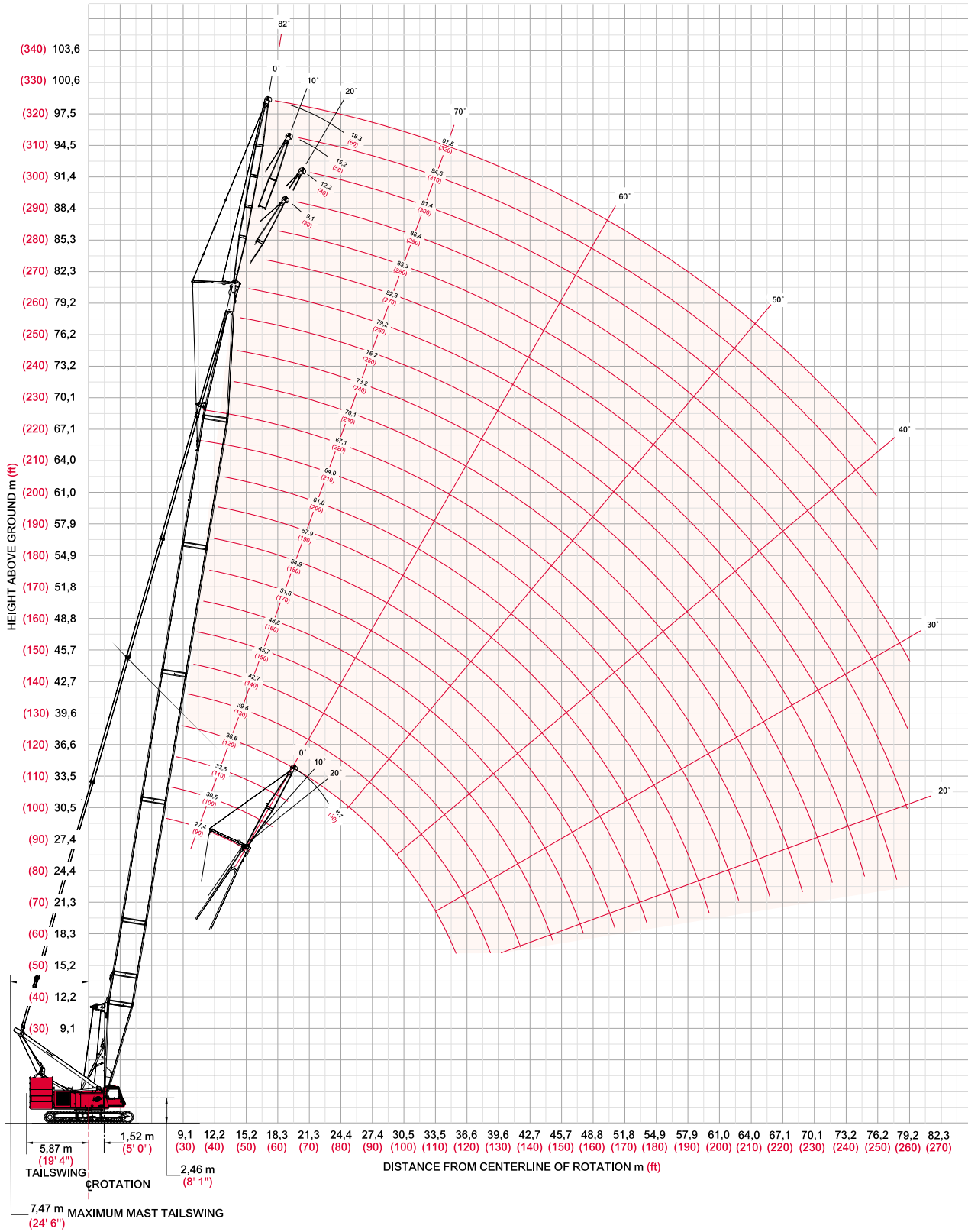

fixed jib load chart

PRELIMINARY

60

Liftcrane Boom Capacities Fixed Jib No. 123 with 3 810 mm (12' 6") strut on Boom No. 22E with Open Throat Top

99 609 kg (219,600 lb) Upperworks Counterweight 36 288 kg (80,000 lb) Carbody Counterweight

360° Rating kg (lb) x 1 000

Boom m (ft)	0° Offset					20° Offset				
	27,4 (90)	39,6 (130)	51,8 (170)	64,0 (210)	79,2 (260)	27,4 (90)	39,6 (130)	51,8 (170)	64,0 (210)	79,2 (260)
Radius										
Jib Length 9,1 m (30 ft)	18,1 (40.0)									
12,0 (40)	18,1 (40.0)	18,1 (40.0)	- (40.0)			- (40.0)				
16,0 (50)	18,1 (40.0)	18,1 (40.0)	18,1 (40.0)	18,1 (40.0)		18,1 (40.0)	18,1 (40.0)	18,1 (40.0)		
18,0 (60)	18,1 (40.0)	18,1 (40.0)	18,1 (40.0)	18,1 (40.0)	18,1 (40.0)	18,1 (40.0)	18,1 (40.0)	18,1 (40.0)	18,1 (40.0)	
22,0 (75)	18,1 (40.0)	18,1 (40.0)	18,1 (40.0)	18,1 (40.0)	18,1 (40.0)	18,1 (39.8)	18,1 (40.0)	18,1 (40.0)	18,1 (40.0)	18,1 (40.0)
32,0 (100)	18,1 (40.0)	18,1 (40.0)	18,0 (40.0)	17,2 (40.0)	16,1 (38.7)	14,5 (33.0)	16,9 (38.5)	18,1 (40.0)	17,9 (40.0)	16,9 (40.0)
44,0 (140)		11,6 (27.1)	10,8 (25.2)	9,9 (23.3)	8,8 (20.9)		- (27.5)	11,1 (25.9)	10,3 (24.2)	9,3 (22.1)
52,0 (170)			7,9 (17.7)	7,1 (15.8)	5,9 (13.3)			- (18.1)	7,3 (16.4)	6,3 (14.2)
64,0 (210)				4,1 (9.2)	3,0 (6.8)					3,3 (7.3)
72,0 (240)										
80,0 (260)										

Boom m (ft)	0° Offset					20° Offset				
	27,4 (90)	39,6 (130)	51,8 (170)	64,0 (210)	79,2 (260)	27,4 (90)	39,6 (130)	51,8 (170)	64,0 (210)	79,2 (260)
Radius										
Jib Length 12,2 m (40 ft)	13,6 (30.0)									
12,0 (40)	13,6 (30.0)	13,6 (30.0)	- (30.0)							
16,0 (50)	13,6 (30.0)	13,6 (30.0)	13,6 (30.0)	13,6 (30.0)		13,6 (30.0)	13,6 (30.0)			
18,0 (60)	13,6 (30.0)	13,6 (30.0)	13,6 (30.0)	13,6 (30.0)	13,6 (30.0)	13,6 (30.0)	13,6 (30.0)	13,6 (30.0)	- (30.0)	
22,0 (75)	13,6 (30.0)	13,6 (30.0)	13,6 (30.0)	13,6 (30.0)	13,6 (30.0)	13,6 (30.0)	13,6 (30.0)	13,6 (30.0)	13,6 (30.0)	13,6 (30.0)
32,0 (100)	13,6 (30.0)	13,6 (30.0)	13,6 (30.0)	13,6 (30.0)	13,5 (30.0)	11,0 (25.1)	12,7 (29.0)	13,6 (30.0)	13,6 (30.0)	13,6 (30.0)
44,0 (140)		11,8 (27.5)	11,0 (25.6)	10,1 (23.6)	9,0 (21.2)		10,4 (23.5)	11,4 (26.3)	10,6 (24.9)	9,7 (22.8)
52,0 (170)		- (19.9)	8,1 (18.1)	7,2 (16.1)	6,1 (13.7)			8,4 (18.7)	7,6 (17.0)	6,6 (14.8)
64,0 (210)				4,3 (9.5)	3,2 (7.1)				4,5 (10.0)	3,5 (7.9)
72,0 (240)				2,8 (6.0)						2,0 (4.2)
80,0 (260)										

Meets ANSI B30.5 Requirements - Capacities do not exceed 75% of static tipping load.
NOTICE: This capacity chart is for reference only and must not be used for lifting purposes.

fixed jib load chart

PRELIMINARY

Liftcrane Boom Capacities Fixed Jib No. 123 with 3 810 mm (12' 6") strut on Boom No. 22E with Open Throat Top

99 609 kg (219,600 lb) Upperworks Counterweight 36 288 kg (80,000 lb) Carbody Counterweight

360° Rating kg (lb) x 1 000

Boom m (ft)	0° Offset					20° Offset				
	27,4 (90)	39,6 (130)	51,8 (170)	64,0 (210)	79,2 (260)	27,4 (90)	39,6 (130)	51,8 (170)	64,0 (210)	79,2 (260)
Jib Length 15,2 m (50 ft)										
Radius 9,1 (30)	9,0 (20.0)									
12,0 (40)	9,0 (20.0)	- (20.0)								
16,0 (50)	9,0 (20.0)	9,0 (20.0)	9,0 (20.0)	9,0 (20.0)		9,0 (20.0)				
18,0 (60)	9,0 (20.0)	9,0 (20.0)	9,0 (20.0)	9,0 (20.0)	- (20.0)	9,0 (20.0)	9,0 (20.0)	9,0 (20.0)		
22,0 (75)	9,0 (20.0)	9,0 (20.0)	9,0 (20.0)	9,0 (20.0)	9,0 (20.0)	9,0 (20.0)	9,0 (20.0)	9,0 (20.0)	9,0 (20.0)	- (20.0)
32,0 (100)	9,0 (20.0)	9,0 (20.0)	9,0 (20.0)	9,0 (20.0)	9,0 (20.0)	9,0 (20.0)	9,0 (20.0)	9,0 (20.0)	9,0 (20.0)	9,0 (20.0)
44,0 (140)	- (19.7)	9,0 (20.0)	9,0 (20.0)	9,0 (20.0)	9,0 (20.0)		8,6 (19.4)	9,0 (20.0)	9,0 (20.0)	9,0 (20.0)
52,0 (170)		9,0 (20.0)	8,2 (18.4)	7,4 (16.5)	6,2 (14.0)			8,6 (19.2)	7,9 (17.6)	6,9 (15.5)
64,0 (210)			5,3 (11.8)	4,4 (9.9)	3,3 (7.4)				4,8 (10.6)	3,8 (8.4)
72,0 (240)				3,0 (6.4)	1,9 (4.0)					2,3 (4.7)
80,0 (260)										

Boom m (ft)	0° Offset					20° Offset				
	27,4 (90)	39,6 (130)	51,8 (170)	64,0 (210)	79,2 (260)	27,4 (90)	39,6 (130)	51,8 (170)	64,0 (210)	79,2 (260)
Jib Length 18,3 m (60 ft)										
Radius 9,1 (30)										
12,0 (40)	4,5 (10.0)	- (10.0)								
16,0 (50)	4,5 (10.0)	4,5 (10.0)	4,5 (10.0)	4,5 (10.0)						
18,0 (60)	4,5 (10.0)	4,5 (10.0)	4,5 (10.0)	4,5 (10.0)	- (10.0)	4,5 (10.0)	- (10.0)			
22,0 (75)	4,5 (10.0)	4,5 (10.0)	4,5 (10.0)	4,5 (10.0)	4,5 (10.0)	4,5 (10.0)	4,5 (10.0)	4,5 (10.0)	4,5 (10.0)	
32,0 (100)	4,5 (10.0)	4,5 (10.0)	4,5 (10.0)	4,5 (10.0)	4,5 (10.0)	4,5 (10.0)	4,5 (10.0)	4,5 (10.0)	4,5 (10.0)	4,5 (10.0)
44,0 (140)	4,5 (10.0)	4,5 (10.0)	4,5 (10.0)	4,5 (10.0)	4,5 (10.0)	- (10.0)	4,5 (10.0)	4,5 (10.0)	4,5 (10.0)	4,5 (10.0)
52,0 (170)		4,5 (10.0)	4,5 (10.0)	4,5 (10.0)	4,5 (10.0)		- (10.0)	4,5 (10.0)	4,5 (10.0)	4,5 (10.0)
64,0 (210)			4,5 (10.0)	4,5 (10.0)	3,4 (7.6)				4,5 (10.0)	3,9 (8.8)
72,0 (240)				3,1 (6.6)	2,0 (4.1)					2,4 (5.1)
80,0 (260)				2,0 (4.7)						

Meets ANSI B30.5 Requirements - Capacities do not exceed 75% of static tipping load.
NOTICE: This capacity chart is for reference only and must not be used for lifting purposes.

61

model 999



fixed jib range diagram

PRELIMINARY

62

No. 123 Fixed Jib on No. 22E Main Boom with Light Tapered Top

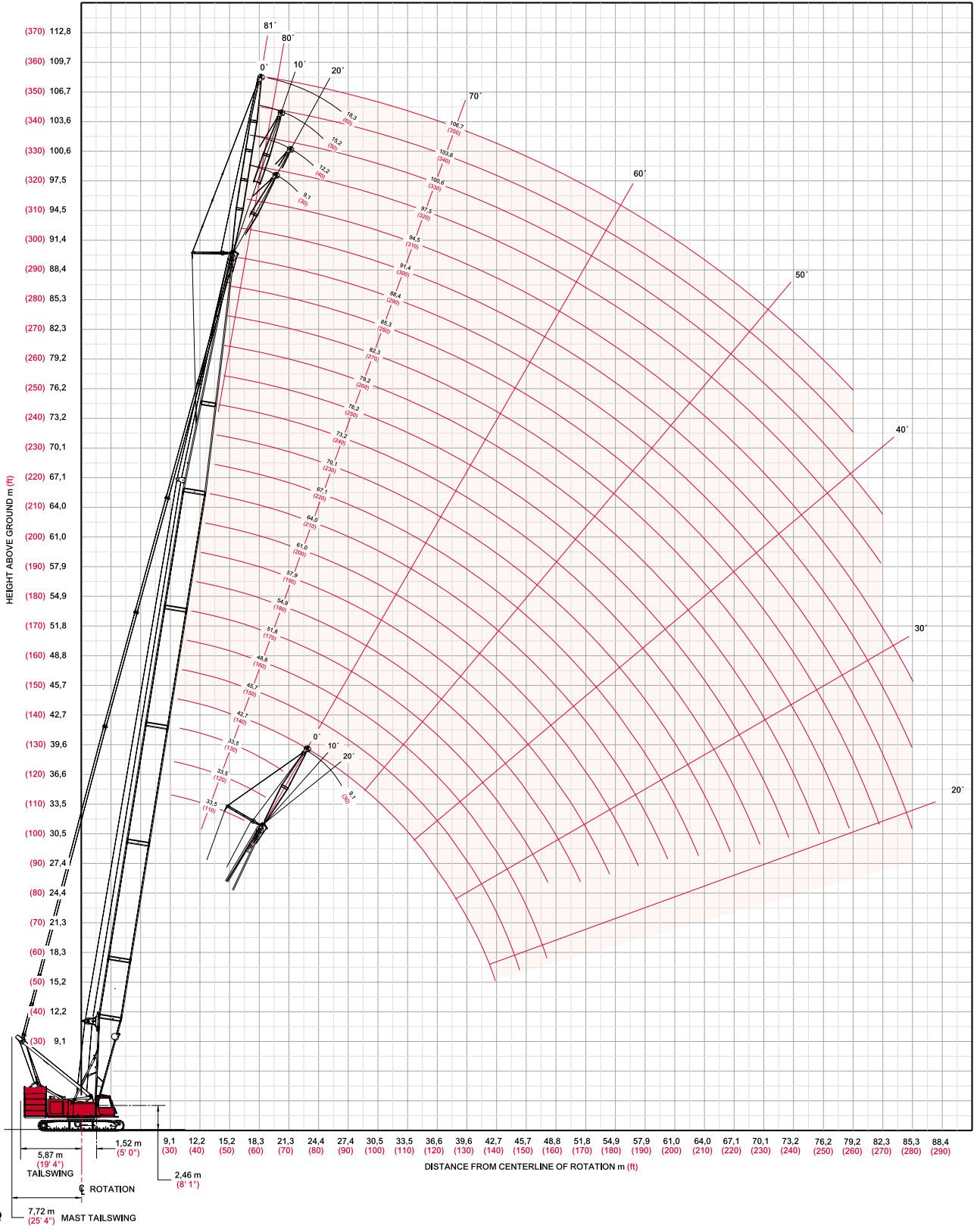

fixed jib load chart

PRELIMINARY

Liftcrane Boom Capacities Fixed Jib No. 123 with 3 810 mm (12' 6") strut on Boom No. 22E with Light Tapered Top

99 609 kg (219,600 lb) Upperworks Counterweight 36 288 kg (80,000 lb) Carbody Counterweight

360° Rating kg (lb) x 1 000

Boom m (ft)	0° Offset					20° Offset				
	33,5 (110)	48,8 (160)	61,0 (200)	73,2 (240)	88,4 (290)	33,5 (110)	48,8 (160)	61,0 (200)	73,2 (240)	88,4 (290)
Radius										
9,1 (30)	18,1 (40.0)									
12,0 (40)	18,1 (40.0)	- (40.0)				- (40.0)				
16,0 (55)	18,1 (40.0)	18,1 (40.0)	18,1 (40.0)	18,1 (40.0)		18,1 (40.0)	18,1 (40.0)	- (40.0)		
20,0 (70)	18,1 (40.0)	18,1 (40.0)	18,1 (40.0)	18,1 (40.0)	18,1 (40.0)	18,1 (40.0)	18,1 (40.0)	18,1 (40.0)	18,1 (40.0)	- (40.0)
28,0 (90)	18,1 (40.0)	18,1 (40.0)	18,1 (40.0)	18,1 (40.0)	18,1 (40.0)	16,8 (37.7)	18,1 (40.0)	18,1 (40.0)	18,1 (40.0)	18,1 (40.0)
36,0 (120)	17,5 (37.9)	16,5 (35.5)	15,6 (33.8)	14,8 (31.9)	13,8 (29.7)	14,4 (31.6)	16,8 (36.3)	16,1 (34.7)	15,3 (33.0)	14,4 (31.0)
48,0 (150)		10,6 (25.4)	9,8 (23.6)	9,0 (21.7)	7,9 (19.5)		10,8 (25.8)	10,1 (24.3)	9,3 (22.6)	8,4 (20.5)
56,0 (180)		8,2 (18.8)	7,4 (17.1)	6,5 (15.2)	5,5 (12.9)			7,6 (17.5)	6,8 (15.7)	5,8 (13.6)
68,0 (220)			4,8 (11.1)	4,0 (9.3)	3,0 (7.0)				4,1 (9.6)	3,2 (7.5)
76,0 (250)				2,7 (6.1)						1,9 (4.2)
84,0 (280)										

Boom m (ft)	0° Offset					20° Offset				
	33,5 (110)	48,8 (160)	61,0 (200)	73,2 (240)	88,4 (290)	33,5 (110)	48,8 (160)	61,0 (200)	73,2 (240)	88,4 (290)
Radius										
9,1 (30)										
12,0 (40)	13,6 (30.0)									
16,0 (55)	13,6 (30.0)	13,6 (30.0)	13,6 (30.0)	- (30.0)		13,6 (30.0)	- (30.0)			
20,0 (70)	13,6 (30.0)	13,6 (30.0)	13,6 (30.0)	13,6 (30.0)	13,6 (30.0)	13,6 (30.0)	13,6 (30.0)	13,6 (30.0)	13,6 (30.0)	
28,0 (90)	13,6 (30.0)	13,6 (30.0)	13,6 (30.0)	13,6 (30.0)	13,6 (30.0)	12,8 (28.7)	13,6 (30.0)	13,6 (30.0)	13,6 (30.0)	13,6 (30.0)
36,0 (120)	13,6 (30.0)	13,6 (30.0)	13,6 (30.0)	13,6 (30.0)	13,5 (29.9)	10,8 (23.8)	12,7 (27.8)	13,6 (30.0)	13,6 (30.0)	13,6 (30.0)
48,0 (150)	- (24.4)	10,7 (25.7)	9,9 (23.9)	9,1 (22.0)	8,0 (19.7)		10,7 (24.2)	10,3 (24.7)	9,5 (23.1)	8,6 (21.1)
56,0 (180)		8,3 (19.0)	7,5 (17.3)	6,6 (15.4)	5,6 (13.1)			7,7 (17.9)	7,0 (16.2)	6,0 (14.1)
68,0 (220)			4,9 (11.3)	4,1 (9.5)	3,0 (7.2)				4,3 (10.0)	3,4 (7.9)
76,0 (250)				2,8 (6.3)	1,8 (4.0)					2,1 (4.6)
84,0 (280)										

Meets ANSI B30.5 Requirements - Capacities do not exceed 75% of static tipping load.
NOTICE: This capacity chart is for reference only and must not be used for lifting purposes.

fixed jib load chart

PRELIMINARY

64

Liftcrane Boom Capacities Fixed Jib No. 123 with 3 810 mm (12' 6") strut on Boom No. 22E with Light Tapered Top

99 609 kg (219,600 lb) Upperworks Counterweight 36 288 kg (80,000 lb) Carbody Counterweight

360° Rating kg (lb) x 1 000

Boom m (ft)	0° Offset					20° Offset				
	33,5 (110)	48,8 (160)	61,0 (200)	73,2 (240)	88,4 (290)	33,5 (110)	48,8 (160)	61,0 (200)	73,2 (240)	88,4 (290)
Radius 9,1 (30)										
12,0 (40)	9,0 (20.0)									
16,0 (55)	9,0 (20.0)	9,0 (20.0)	9,0 (20.0)	- (20.0)		9,0 (20.0)				
20,0 (70)	9,0 (20.0)	9,0 (20.0)	9,0 (20.0)	9,0 (20.0)	9,0 (20.0)	9,0 (20.0)	9,0 (20.0)	9,0 (20.0)	- (20.0)	
28,0 (90)	9,0 (20.0)	9,0 (20.0)	9,0 (20.0)	9,0 (20.0)	9,0 (20.0)	9,0 (20.0)	9,0 (20.0)	9,0 (20.0)	9,0 (20.0)	9,0 (20.0)
36,0 (120)	9,0 (20.0)	9,0 (20.0)	9,0 (20.0)	9,0 (20.0)	9,0 (20.0)	9,0 (19.8)	9,0 (20.0)	9,0 (20.0)	9,0 (20.0)	9,0 (20.0)
48,0 (150)	8,9 (20.0)	9,0 (20.0)	9,0 (20.0)	9,0 (20.0)	8,2 (20.0)		8,7 (20.0)	9,0 (20.0)	9,0 (20.0)	8,8 (20.0)
56,0 (180)		8,4 (19.3)	7,6 (17.5)	6,7 (15.6)	5,7 (13.3)		- (17.8)	7,9 (18.3)	7,2 (16.7)	6,3 (14.7)
68,0 (220)			5,0 (11.6)	4,2 (9.7)	3,1 (7.4)				4,5 (10.4)	3,5 (8.3)
76,0 (250)				2,9 (6.5)	1,9 (4.3)					2,2 (5.0)
84,0 (280)				1,9 (4.0)						

Boom m (ft)	0° Offset					20° Offset				
	33,5 (110)	48,8 (160)	61,0 (200)	73,2 (240)	88,4 (290)	33,5 (110)	48,8 (160)	61,0 (200)	73,2 (240)	88,4 (290)
Radius 9,1 (30)										
12,0 (40)	4,5 (10.0)									
16,0 (55)	4,5 (10.0)	4,5 (10.0)	4,5 (10.0)	4,5 (10.0)		- (10.0)				
20,0 (70)	4,5 (10.0)	4,5 (10.0)	4,5 (10.0)	4,5 (10.0)	4,5 (10.0)	4,5 (10.0)	4,5 (10.0)	- (10.0)		
28,0 (90)	4,5 (10.0)	4,5 (10.0)	4,5 (10.0)	4,5 (10.0)	4,5 (10.0)	4,5 (10.0)	4,5 (10.0)	4,5 (10.0)	4,5 (10.0)	4,5 (10.0)
36,0 (120)	4,5 (10.0)	4,5 (10.0)	4,5 (10.0)	4,5 (10.0)	4,5 (10.0)	4,5 (10.0)	4,5 (10.0)	4,5 (10.0)	4,5 (10.0)	4,5 (10.0)
48,0 (150)	4,5 (10.0)	4,5 (10.0)	4,5 (10.0)	4,5 (10.0)	4,5 (10.0)	- (10.0)	4,5 (10.0)	4,5 (10.0)	4,5 (10.0)	4,5 (10.0)
56,0 (180)		4,5 (10.0)	4,5 (10.0)	4,5 (10.0)	4,5 (10.0)		4,5 (10.0)	4,5 (10.0)	4,5 (10.0)	4,5 (10.0)
68,0 (220)			4,5 (10.0)	4,2 (9.8)	3,2 (7.5)			4,5 (10.0)	4,5 (10.0)	3,7 (8.6)
76,0 (250)			3,8 (8.5)	3,0 (6.7)	1,9 (4.3)				3,3 (7.2)	2,3 (5.2)
84,0 (280)				2,0 (4.2)						

model 999



Meets ANSI B30.5 Requirements - Capacities do not exceed 75% of static tipping load.
NOTICE: This capacity chart is for reference only and must not be used for lifting purposes.

luffing jib range diagram

No. 135 Luffing Jib on No. 82 or No. 22EL Main Boom

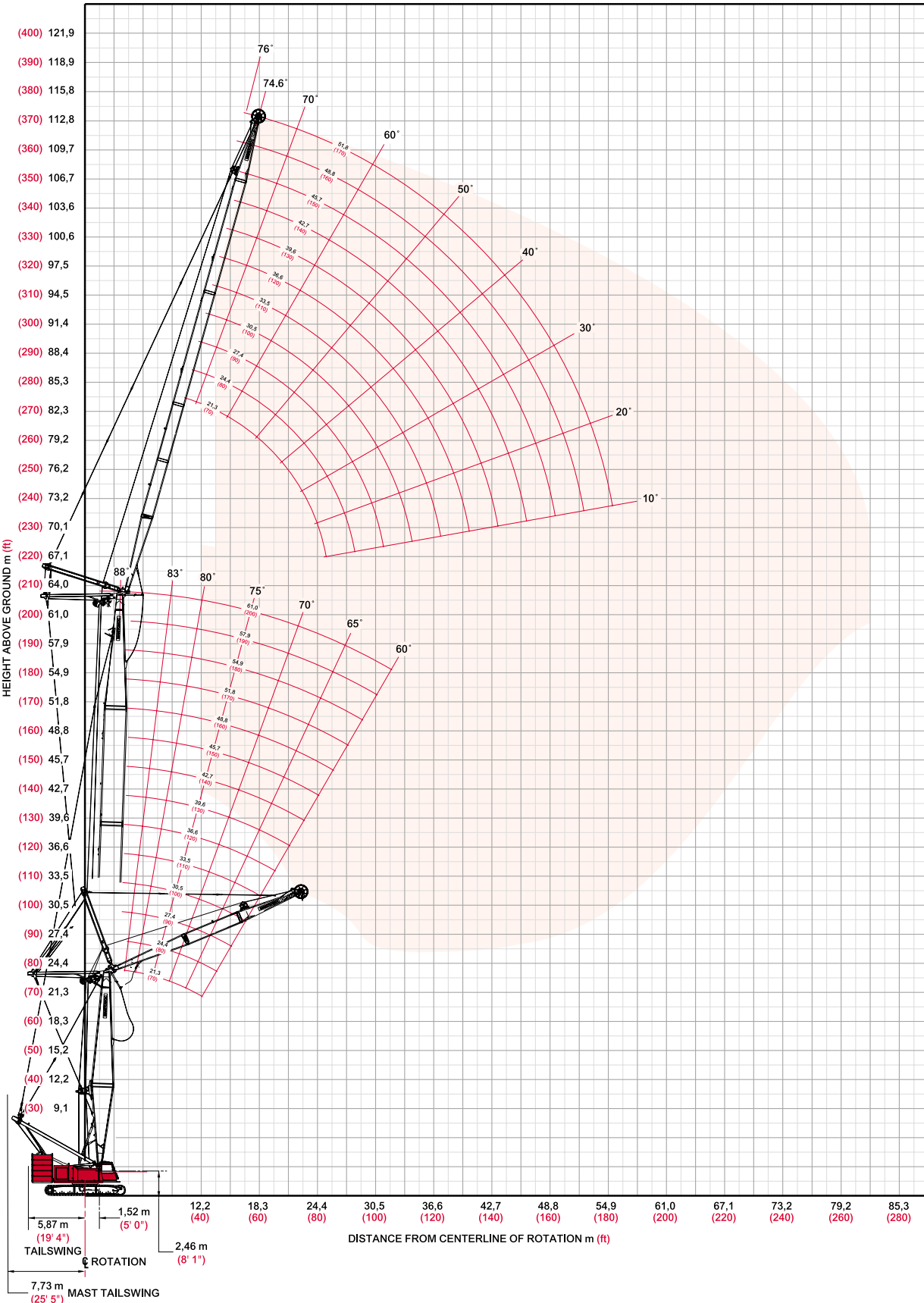

Luffing jib load charts

66

Liftcrane Luffing Jib Capacities - Series 3

Luffing Jib No. 135 on Boom No. 82 or No. 22EL

99 609 kg (219,600 lb) Upperworks Counterweight 36 288 kg (80,000 lb) Carbody Counterweight

360° Rating

kg (lb) x 1 000

88° Boom Angle

Luffing Jib Length	Boom					Luffing Jib Length	Boom						
	m (ft)	21,3 (70)	30,5 (100)	42,7 (140)	51,8 (170)		61,0 (200)	m (ft)	21,3 (70)	30,5 (100)	42,7 (140)	51,8 (170)	61,0 (200)
21,3 m (70 ft)	Radius						30,5 m (100 ft)	Radius					
	12,2 (40)	46,1 (101.8)						12,2 (40)	35,3 (77.9)	35,1 (77.6)			
	14,0 (45)	43,5 (96.7)	43,7 (96.9)	44,1 (98.0)				14,0 (45)	33,8 (75.3)	33,8 (75.1)	33,3 (74.2)	31,9 (70.7)	
	16,0 (50)	41,7 (93.8)	41,8 (94.1)	41,7 (93.9)	39,8 (89.4)	35,3 (80.2)		16,0 (50)	31,7 (71.7)	31,7 (71.6)	31,5 (71.0)	31,1 (69.8)	25,1 (55.9)
	18,0 (60)	38,7 (84.3)	39,6 (86.9)	39,7 (87.1)	38,0 (83.3)	32,6 (71.1)		18,0 (60)	29,8 (65.2)	29,9 (65.4)	29,8 (65.2)	29,4 (64.5)	24,4 (53.8)
	22,0 (70)	28,7 (68.3)	30,8 (71.6)	31,8 (73.5)	31,0 (71.1)	27,7 (62.7)		22,0 (70)	26,5 (59.6)	26,6 (59.9)	26,7 (60.1)	26,6 (59.8)	23,2 (51.9)
	24,0 (80)		23,7 (47.6)	25,4 (51.8)	26,3 (55.1)	25,6 (55.7)		24,0 (80)	25,1 (54.9)	25,3 (55.3)	25,4 (55.7)	25,2 (55.1)	21,8 (47.5)
	26,0 (90)							26,0 (90)	23,8 (49.2)	24,1 (48.1)	24,3 (51.9)	23,4 (48.6)	20,3 (42.7)
	28,0 (100)							28,0 (100)	21,7 (42.3)	22,8 (44.9)	23,1 (45.7)	21,5 (43.0)	18,9 (38.4)
	30,0 (105)							30,0 (105)	19,6 (35.4)	20,8 (41.9)	21,2 (42.8)	19,8 (40.5)	17,7 (36.6)
	32,0 (110)							32,0 (110)	16,0 -	19,0 (33.0)	19,4 (35.6)	18,3 (38.2)	16,6 (35.2)

Luffing Jib Length	Boom					Luffing Jib Length	Boom						
	m (ft)	21,3 (70)	30,5 (100)	42,7 (140)	51,8 (170)		61,0 (200)	m (ft)	21,3 (70)	30,5 (100)	42,7 (140)	51,8 (170)	61,0 (200)
42,7 m (140 ft)	Radius						51,8 m (170 ft)	Radius					
	13,7 (45)	23,7 (52.3)	23,4 (51.6)					13,7 (45)					
	16,0 (50)	22,2 (50.1)	22,1 (49.8)	21,6 (48.3)	20,7 (46.2)	19,7 (43.8)		16,0 (50)					
	18,0 (60)	20,9 (45.9)	20,9 (45.8)	20,7 (45.3)	20,2 (44.6)	19,3 (42.5)		18,0 (60)	16,5 (36.2)	16,5 (36.1)	16,2 (35.6)	15,9 (35.0)	- (32.3)
	22,0 (70)	18,6 (42.0)	18,7 (42.1)	18,7 (42.0)	18,5 (41.6)	17,9 (40.1)		22,0 (70)	14,6 (32.9)	14,6 (32.9)	14,6 (32.8)	14,4 (32.4)	13,9 (31.0)
	24,0 (80)	17,6 (38.5)	17,7 (38.7)	17,7 (38.8)	17,6 (38.6)	17,2 (37.6)		24,0 (80)	13,7 (29.8)	13,7 (30.0)	13,7 (30.0)	13,7 (29.9)	13,5 (29.6)
	30,0 (100)	14,8 (32.4)	15,0 (32.7)	15,1 (33.0)	15,2 (33.2)	14,8 (32.3)		30,0 (100)	11,2 (24.4)	11,3 (24.7)	11,4 (24.9)	11,5 (25.1)	11,5 (25.1)
	38,0 (120)	12,0 (27.5)	12,1 (27.8)	12,3 (28.2)	12,5 (28.5)	11,8 (27.3)		38,0 (120)	8,6 (19.9)	8,6 (20.1)	8,8 (20.5)	9,0 (20.7)	9,1 (21.0)
	44,0 (140)	9,4 (23.8)	10,6 (24.0)	10,7 (24.4)	10,8 (24.7)	10,1 (23.1)		44,0 (140)	6,9 (16.1)	7,0 (16.4)	7,2 (16.7)	7,3 (17.0)	7,4 (17.3)
	50,0 (160)							50,0 (160)	5,6 (13.1)	5,7 (13.3)	5,9 (13.6)	6,0 (13.9)	6,1 (14.2)
	54,0 (180)							54,0 (180)		4,8 (10.2)	4,9 (10.6)	5,1 (10.9)	5,2 (11.2)

model 999



Meets ANSI B30.5 Requirements - Capacities do not exceed 75% of static tipping load.
 NOTICE: This capacity chart is for reference only and must not be used for lifting purposes.

luffing jib load charts

67

Liftcrane Luffing Jib Capacities - Series 3 Luffing Jib No. 135 on Boom No. 82 or No. 22EL

99 609 kg (219,600 lb) Upperworks Counterweight 36 288 kg (80,000 lb) Carbody Counterweight

360° Rating

kg (lb) x 1 000

75° Boom Angle

Boom m (ft)	21,3 (70)	30,5 (100)	42,7 (140)	51,8 (170)	61,0 (200)
Radius					
20,0 (60)	43,4 (100.4)	44,8 -			
22,0 (70)	40,8 (92.5)	39,8 (91.3)			
24,0 (80)	36,0 (77.0)	35,8 (77.5)	- (73.7)		
28,0 (90)	26,6 (63.1)	29,7 (67.2)	28,2 (63.8)	26,8 (60.8)	
30,0 (100)		27,2 (59.0)	25,9 (56.1)	24,7 (53.5)	23,6 (51.2)
34,0 (110)			(49.8)	21,1 (47.5)	20,2 (45.5)
36,0 (120)				19,7 (42.6)	18,8 (40.8)
42,0 (140)					
44,0 (150)					
46,0 (155)					

Boom m (ft)	21,3 (70)	30,5 (100)	42,7 (140)	51,8 (170)	61,0 (200)
Radius					
20,0 (60)					
22,0 (70)					
24,0 (80)	29,2 (63.8)	- (67.6)			
28,0 (90)	26,3 (58.9)	27,9 (62.6)	27,8 (62.8)		
30,0 (100)	24,9 (54.0)	26,6 (58.1)	25,5 (55.2)	(52.4)	
34,0 (110)	20,5 (46.3)	23,1 (51.9)	21,8 (49.1)	20,7 (46.6)	19,7 (44.4)
36,0 (120)	18,6 (40.1)	21,5 (46.4)	20,4 (44.1)	19,3 (41.8)	18,4 (39.9)
42,0 (140)			16,7 (36.3)	15,9 (34.4)	15,1 (32.8)
44,0 (150)				15,0 (31.4)	14,2 (30.0)
46,0 (155)					13,4 (28.7)

Boom m (ft)	21,3 (70)	30,5 (100)	42,7 (140)	51,8 (170)	61,0 (200)
Radius					
28,0 (90)	18,0 (40.4)				
30,0 (100)	17,1 (37.3)	- (39.5)			
34,0 (110)	15,4 (34.4)	16,4 (36.6)	17,5 (39.1)		
38,0 (120)	13,8 (31.7)	14,7 (33.8)	16,0 (36.6)	16,7 (38.0)	
42,0 (140)	12,4 (27.0)	13,3 (28.9)	14,5 (31.6)	15,4 (33.4)	14,6 (31.7)
46,0 (150)	11,3 (25.1)	12,0 (26.7)	13,1 (29.3)	13,7 (30.6)	13,0 (29.0)
50,0 (160)	9,3 (23.6)	10,9 (24.9)	11,9 (27.2)	12,3 (28.1)	11,6 (26.6)
54,0 (180)			10,9 (23.9)	11,1 (24.0)	10,5 (22.7)
60,0 (200)					
68,0 (220)					

Boom m (ft)	21,3 (70)	30,5 (100)	42,7 (140)	51,8 (170)	61,0 (200)
Radius					
28,0 (90)					
30,0 (100)					
34,0 (110)	11,5 (25.9)				
38,0 (120)	10,1 (23.5)	11,0 (25.3)			
42,0 (140)	8,9 (19.2)	9,6 (20.9)	10,7 (23.2)	11,4 (24.7)	- (25.4)
46,0 (150)	7,7 (17.3)	8,4 (18.9)	9,4 (21.1)	10,2 (22.8)	10,8 (24.1)
50,0 (160)	6,7 (15.6)	7,4 (17.0)	8,3 (19.1)	9,1 (20.8)	9,8 (22.4)
54,0 (180)	5,8 (12.5)	6,4 (13.8)	7,3 (15.6)	8,0 (17.2)	8,7 (18.7)
60,0 (200)		5,0 (10.6)	5,9 (12.5)	6,5 (14.0)	7,2 (15.5)
68,0 (220)				- (10.8)	5,3 (12.3)

Meets ANSI B30.5 Requirements - Capacities do not exceed 75% of static tipping load.
NOTICE: This capacity chart is for reference only and must not be used for lifting purposes.

Luffing jib load charts

68

Liftcrane Luffing Jib Capacities - Series 3

Luffing Jib No. 135 on Boom No. 82 or No. 22EL

99 609 kg (219,600 lb) Upperworks Counterweight 36 288 kg (80,000 lb) Carbody Counterweight

360° Rating

kg (lb) x 1 000

60° Boom Angle

Luffing Jib Length	Boom					Luffing Jib Length	Boom					
	m (ft)	21,3 (70)	30,5 (100)	42,7 (140)	51,8 (170)		61,0 (200)	m (ft)	21,3 (70)	30,5 (100)	42,7 (140)	51,8 (170)
21,3 m (70 ft)	Radius						Radius					
	28,0 (90)	28,4 (64.3)					28,0 (90)					
	30,0 (100)	26,1 (56.5)					30,0 (100)					
	34,0 (110)	- (50.2)	20,7 (46.6)				34,0 (110)	21,4 (47.6)				
	38,0 (120)		18,0 (41.8)				38,0 (120)	19,2 (44.4)				
	42,0 (140)			14,0 (30.3)	- (26.6)		42,0 (140)	16,9 (36.5)	15,6 (33.7)			
	46,0 (150)				10,8 (24.2)		46,0 (150)		13,8 (30.8)	12,0 (26.7)		
	50,0 (160)				- (22.1)	8,5 (19.5)	50,0 (160)			10,7 (24.5)	9,2 (21.1)	
	54,0 (180)						54,0 (180)				8,2 (17.9)	7,1 (15.3)
	60,0 (200)						60,0 (200)					6,0 (13.0)
64,0 (210)						64,0 (210)						
42,7 m (140 ft)	Radius						Radius					
	44,0 (140)	13,3 (30.3)					44,0 (140)					
	46,0 (145)	12,7 (29.3)					46,0 (145)					
	50,0 (150)	11,6 (28.3)	12,0 -				50,0 (150)	8,0 -				
	54,0 (160)	10,7 (26.3)	10,8 (27.4)	9,1 -			54,0 (160)	7,0 (18.3)	8,1 -			
	58,0 (180)	- (23.5)	9,7 (23.3)	8,2 (19.8)	6,9 -		58,0 (180)	6,1 (15.1)	7,1 (17.5)			
	62,0 (200)			7,5 (17.0)	6,2 (14.2)		62,0 (200)	5,1 (11.9)	6,3 (14.4)	7,2 (16.3)		
	66,0 (220)				5,6 (12.2)	4,7 (10.1)	66,0 (220)		5,3 (11.3)	6,5 (14.0)	5,3 (11.4)	
	72,0 (240)					3,9 (8.5)	72,0 (240)			5,4 (11.5)	4,5 (9.8)	3,6 (7.8)
	76,0 (260)						76,0 (260)				4,1 (8.3)	3,2 (6.5)
80,0 (270)						80,0 (270)					2,8 (6.0)	
51,8 m (170 ft)	Radius						Radius					
	44,0 (140)						44,0 (140)					
	46,0 (145)						46,0 (145)					
	50,0 (150)						50,0 (150)					
	54,0 (160)						54,0 (160)					
	58,0 (180)						58,0 (180)					
	62,0 (200)						62,0 (200)					
	66,0 (220)						66,0 (220)					
	72,0 (240)						72,0 (240)					
	76,0 (260)						76,0 (260)					
80,0 (270)						80,0 (270)						

model 999



Meets ANSI B30.5 Requirements - Capacities do not exceed 75% of static tipping load.
 NOTICE: This capacity chart is for reference only and must not be used for lifting purposes.

luffing jib range diagram

PRELIMINARY

No. 149 Luffing Jib on No. 82 Main Boom

69

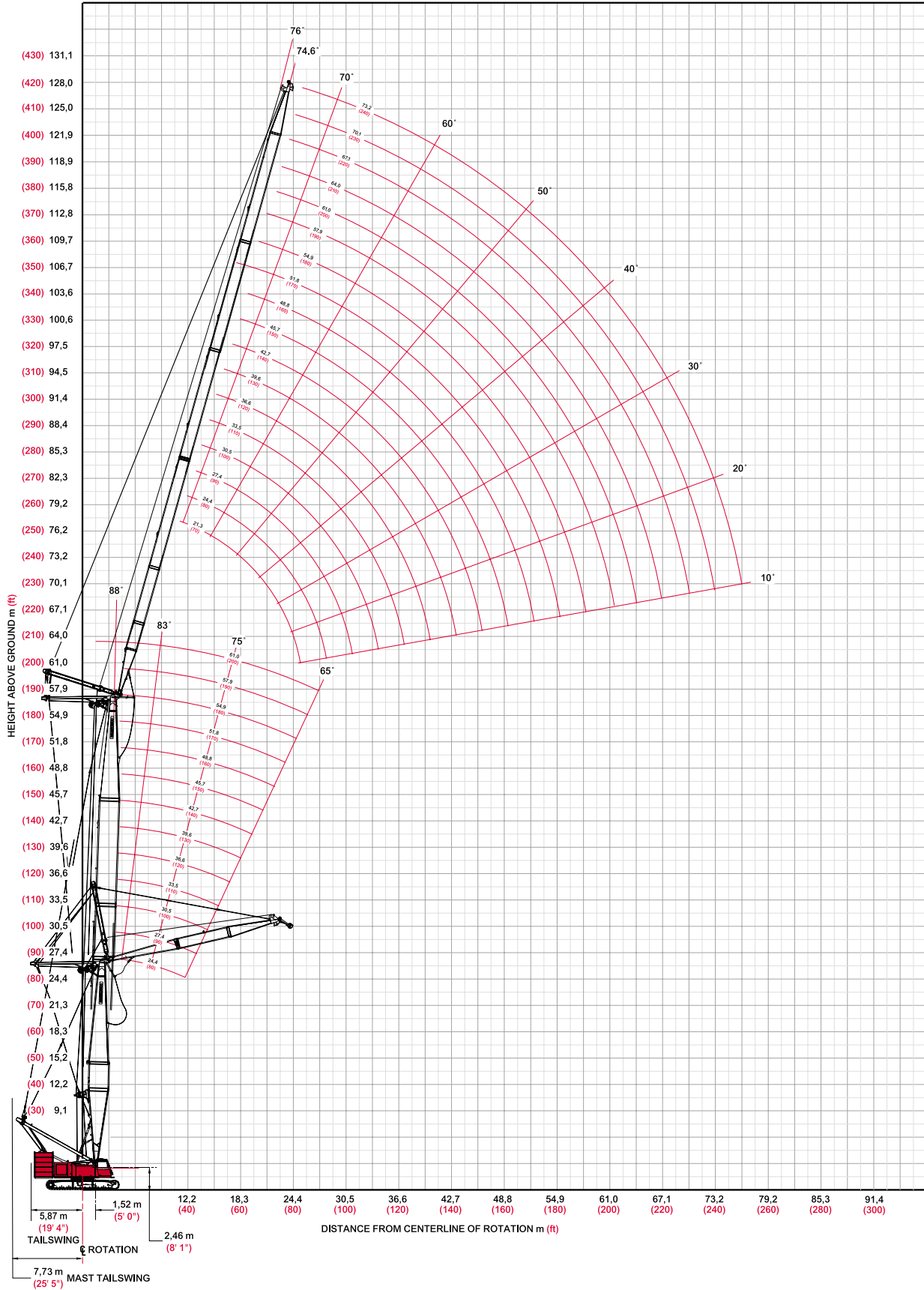

Luffing jib load charts

PRELIMINARY

70

Liftcrane Luffing Jib Capacities - Series 3 Luffing Jib No. 149 on Boom No. 82

99 609 kg (219,600 lb) Upperworks Counterweight 36 288 kg (80,000 lb) Carbody Counterweight

360° Rating

kg (lb) x 1 000

88° Boom Angle

Luffing Jib Length	Boom					Luffing Jib Length	Boom					
	m (ft)	24,4 (80)	36,6 (120)	42,7 (140)	54,9 (180)		61,0 (200)	m (ft)	24,4 (80)	36,6 (120)	42,7 (140)	54,9 (180)
21,3 m (70 ft)	Radius						Radius					
	11,6 (38)	71,4 (157.5)					11,6 (38)					
	14,0 (40)	61,7 (151.6)	57,1	56,3	50,7		14,0 (40)	53,7	48,4	46,8	35,9	
	16,0 (45)	55,4 (138.4)	51,8 (127.7)	51,5 (125.9)	46,3 (113.2)	40,4	16,0 (45)	48,9 (119.9)	44,6 (107.9)	43,6 (104.3)	34,7 (79.6)	29,9
	18,0 (55)	50,1 (117.7)	47,3 (110.3)	47,4 (110.1)	41,7 (98.2)	37,0 (86.6)	18,0 (55)	44,7 (104.2)	41,3 (95.6)	40,6 (93.7)	32,7 (75.2)	28,8 (65.2)
	20,0 (70)	44,7 (90.4)	43,6 (91.7)	43,3 (88.4)	37,7 (78.1)	33,8 (70.4)	20,0 (70)	41,1 (86.0)	38,2 (80.4)	37,9 (79.5)	30,4 (63.9)	27,0 (56.8)
	24,0 (80)	25,5 (50.1)	32,6 (66.2)	32,3 (67.1)	32,1 (70.2)	28,7 (62.3)	24,0 (80)	35,1 (76.4)	33,2 (72.4)	31,8 (69.0)	26,0 (56.6)	23,3 (50.8)
	28,0 (100)						28,0 (100)	29,9 (58.2)	28,8 (56.0)	26,4 (51.8)	22,1 (44.1)	20,0 (40.3)
	30,0 (110)						30,0 (110)	27,0 (50.7)	26,0 (48.6)	24,0 (45.3)	20,3 (39.2)	18,5 (36.0)
	34,0 (120)						34,0 (120)	22,5 (41.4)	21,5 (43.0)	20,1 (40.4)	17,4 (35.4)	16,0 (32.7)
38,0 (130)						38,0 (130)	16,1 (25.4)	18,6 (34.8)	17,5 (34.9)	15,4 (33.3)	14,3 (30.8)	

Luffing Jib Length	Boom					Luffing Jib Length	Boom				
	m (ft)	24,4 (80)	36,6 (120)	42,7 (140)	54,9 (180)		61,0 (200)	m (ft)	24,4 (80)	36,6 (120)	42,7 (140)
51,8 m (170 ft)	Radius						Radius				
	18,0 (55)	37,9 (85.2)	33,4 (74.3)	30,1 (67.0)			18,0 (55)				
	22,0 (60)	33,4 (83.2)	30,4 (73.6)	27,4 (66.3)	22,1 (52.2)	19,7 (45.9)	22,0 (60)	19,0			
	26,0 (75)	29,3 (71.7)	27,0 (65.6)	24,4 (59.2)	19,8 (47.8)	17,7 (42.6)	26,0 (75)	18,3 (41.7)	16,4 (37.4)	15,4 (34.9)	12,8 (29.0)
	30,0 (100)	25,9 (56.4)	23,5 (51.0)	21,3 (46.4)	17,5 (38.2)	15,7 (34.3)	30,0 (100)	17,5 (38.5)	15,9 (35.0)	14,9 (32.8)	12,3 (27.0)
	36,0 (125)	20,6 (41.8)	18,8 (38.4)	17,2 (35.3)	14,4 (29.7)	13,0 (27.0)	36,0 (125)	15,0 (30.9)	14,6 (30.6)	13,3 (28.1)	10,9 (23.0)
	44,0 (150)	15,2 (31.7)	14,0 (29.1)	12,9 (27.0)	11,1 (23.2)	10,1 (21.4)	44,0 (150)	11,3 (23.5)	11,4 (23.6)	11,0 (23.4)	9,0 (19.2)
	52,0 (180)	9,8 (13.1)	10,9 (19.1)	10,3 (19.0)	8,9 (19.2)	8,2 (17.0)	52,0 (180)	8,3 (16.4)	8,4 (16.7)	8,5 (16.8)	7,4 (15.1)
	60,0 (200)						60,0 (200)	5,9 (12.6)	6,0 (12.8)	6,1 (13.0)	5,8 (12.4)
	68,0 (230)						68,0 (230)	3,9 (7.6)	4,0 (7.6)	3,9 (7.6)	3,7 (7.2)
76,0 (250)						76,0 (250)		2,0 (4.5)	2,0 (4.5)	1,9 (4.3)	

Meets ANSI B30.5 Requirements - Capacities do not exceed 75% of static tipping load.
NOTICE: This capacity chart is for reference only and must not be used for lifting purposes.

model 999



luffing jib load charts

PRELIMINARY

Liftcrane Luffing Jib Capacities - Series 3 Luffing Jib No. 149 on Boom No. 82

71

99 609 kg (219,600 lb) Upperworks Counterweight 36 288 kg (80,000 lb) Carbody Counterweight

360° Rating kg (lb) x 1 000

83° Boom Angle

Boom m (ft)	24,4 (80)	36,6 (120)	42,7 (140)	54,9 (180)	61,0 (200)
Radius					
13,7 (45)	70,3 (155.1)				
16,0 (50)	61,4 (141.5)				
18,0 (60)	54,2 (117.0)	53,1 (115.2)	52,8 (114.1)		
20,0 (70)	47,3 (96.3)	46,6 (94.9)	46,2 (93.9)	45,1 (91.8)	41,2 (86.2)
22,0 (80)	42,0 (81.4)	41,4 (80.2)	40,9 (79.4)	40,0 (77.6)	37,8 (73.5)
26,0 (90)		33,5 (69.0)	33,2 (68.4)	32,4 (66.9)	30,8 (63.7)
30,0 (100)					25,8 (55.9)
32,0 (120)					
38,0 (140)					
44,0 (150)					

Boom m (ft)	24,4 (80)	36,6 (120)	42,7 (140)	54,9 (180)	61,0 (200)
Radius					
13,7 (45)					
16,0 (50)					
18,0 (60)	- (106.9)				
20,0 (70)	44,9 (93.8)	43,2 (90.6)	43,1 (91.2)	- (78.0)	
22,0 (80)	41,2 (80.1)	40,0 (78.6)	40,1 (77.7)	35,2 (74.7)	- (64.8)
26,0 (90)	33,5 (69.0)	32,8 (67.7)	32,5 (67.0)	31,6 (65.2)	28,7 (61.0)
30,0 (100)	27,9 (60.4)	27,4 (59.3)	27,1 (58.6)	26,3 (57.0)	24,7 (53.4)
32,0 (120)	25,7 (47.8)	25,2 (46.9)	24,9 (46.3)	24,3 (45.1)	22,7 (42.1)
38,0 (140)	20,6 (-)	20,2 (37.4)	19,9 (37.7)	19,4 (36.7)	18,1 (34.1)
44,0 (150)				15,9 (-)	14,8 (30.9)

Boom m (ft)	24,4 (80)	36,6 (120)	42,7 (140)	54,9 (180)	61,0 (200)
Radius					
24,0 (75)	33,8 (77.4)				
30,0 (80)	27,2 (73.7)	26,7 (70.2)	26,3 (-)	22,9 (-)	19,9 (-)
36,0 (90)	21,4 (66.8)	20,9 (64.5)	20,7 (64.6)	20,0 (51.1)	18,5 (44.9)
42,0 (110)	17,4 (51.9)	17,0 (50.8)	16,7 (50.1)	16,2 (48.6)	14,7 (42.8)
48,0 (130)	14,3 (41.6)	14,1 (40.7)	13,9 (40.1)	13,3 (38.9)	12,0 (35.4)
54,0 (160)	10,9 (30.7)	11,8 (30.5)	11,7 (30.0)	11,1 (28.7)	9,9 (25.9)
60,0 (190)		- (20.8)	- (21.9)	- (21.8)	8,2 (19.4)
66,0 (220)					
70,0 (240)					
74,0 (260)					

Boom m (ft)	24,4 (80)	36,6 (120)	42,7 (140)	54,9 (180)
Radius				
24,0 (75)				
30,0 (80)				
36,0 (90)	16,2 (-)	15,1 (-)	14,4 (-)	12,2 (-)
42,0 (110)	13,3 (37.0)	13,8 (34.0)	13,8 (32.2)	11,8 (27.2)
48,0 (130)	10,7 (31.9)	11,2 (32.8)	11,4 (31.1)	11,0 (26.5)
54,0 (160)	8,5 (23.0)	9,0 (24.2)	9,2 (24.7)	9,0 (23.7)
60,0 (190)	6,6 (16.0)	7,0 (17.0)	7,3 (17.6)	7,2 (17.3)
66,0 (220)	5,0 (10.5)	5,4 (11.4)	5,6 (11.8)	5,6 (12.0)
74,0 (240)	3,0 (7.3)	3,3 (8.0)	3,5 (8.4)	3,7 (8.7)
80,0 (265)				2,2 (4.7)

Meets ANSI B30.5 Requirements - Capacities do not exceed 75% of static tipping load.
NOTICE: This capacity chart is for reference only and must not be used for lifting purposes.

model 999



Luffing jib load charts

72

PRELIMINARY

Liftcrane Luffing Jib Capacities - Series 3

Luffing Jib No. 149 on Boom No. 82

99 609 kg (219,600 lb) Upperworks Counterweight 36 288 kg (80,000 lb) Carbody Counterweight

360° Rating

kg (lb) x 1 000

75° Boom Angle

Luffing Jib Length	Boom m (ft)					Luffing Jib Length	Boom m (ft)				
	24,4 (80)	36,6 (120)	42,7 (140)	54,9 (180)	61,0 (200)		24,4 (80)	36,6 (120)	42,7 (140)	54,9 (180)	61,0 (200)
Radius						Radius					
19,8 (65)	45,7 (100.9)					19,8 (65)					
22,0 (70)	40,1 (91.9)					22,0 (70)					
26,0 (80)	32,5 (77.7)	31,0 (74.2)	30,2 (72.3)			26,0 (80)	31,7				
30,0 (100)		25,9 (56.0)	25,2 (54.6)	23,6 (51.0)	22,6 (49.0)	30,0 (100)	26,4 (57.1)	25,0 (54.1)	- (52.4)		
34,0 (120)				20,1 (40.2)	19,3 (38.7)	34,0 (120)	22,5 (45.2)	21,2 (42.7)	20,6 (41.3)	19,0 (38.1)	- (36.3)
38,0 (130)					16,6	38,0 (130)	19,4 (40.6)	18,3 (38.4)	17,7 (37.1)	16,4 (34.2)	15,6 (32.6)
42,0 (140)						42,0 (140)	17,0 (36.8)	16,0 (34.7)	15,5 (33.6)	14,3 (30.9)	13,6 (29.4)
46,0 (150)						46,0 (150)		14,2 (31.6)	13,7 (30.5)	12,6 (28.1)	12,0 (26.7)
48,0 (160)						48,0 (160)			12,9 (27.8)	11,8 (25.6)	11,2 (24.3)
52,0 (170)						52,0 (170)				- (23.3)	10,0 (22.2)

Luffing Jib Length	Boom m (ft)					Luffing Jib Length	Boom m (ft)				
	24,4 (80)	36,6 (120)	42,7 (140)	54,9 (180)	61,0 (200)		24,4 (80)	36,6 (120)	42,7 (140)	54,9 (180)	
Radius						Radius					
34,0 (110)	21,7 (48.8)					34,0 (110)					
40,0 (115)	17,4 (46.0)	16,3	15,7			40,0 (115)					
46,0 (125)	14,3 (41.1)	13,4 (38.5)	12,9 (37.1)	11,7	11,0	46,0 (125)	12,9	12,0			
52,0 (140)	12,0 (35.2)	11,1 (32.9)	10,7 (31.7)	9,6 (28.9)	9,1 (27.3)	52,0 (140)	10,5 (31.6)	9,8	9,3	8,2	
58,0 (160)	10,1 (29.1)	9,4 (27.2)	9,0 (26.1)	8,1 (23.7)	7,6 (22.3)	58,0 (160)	8,3 (26.1)	8,1 (24.1)	7,6 (22.9)	6,6	
64,0 (190)	- (22.4)	- (20.9)	7,6 (20.0)	6,8 (18.0)	6,3 (16.8)	64,0 (190)	6,4 (18.5)	6,7 (18.0)	6,3 (17.0)	5,4 (14.8)	
70,0 (230)						70,0 (230)	4,9 (10.8)	5,5 (12.3)	5,2 (11.5)	4,4 (9.8)	
76,0 (260)						76,0 (260)	3,5 (5.9)	4,3 (7.8)	4,3 (8.5)	3,6 (7.0)	
82,0 (280)						82,0 (280)		2,7	3,2 (5.2)	2,8 (5.5)	
88,0 (290)						88,0 (290)				2,2 (4.8)	

model 999



Meets ANSI B30.5 Requirements - Capacities do not exceed 75% of static tipping load.
 NOTICE: This capacity chart is for reference only and must not be used for lifting purposes.

Luffing jib load charts

PRELIMINARY

Liftcrane Luffing Jib Capacities - Series 3

Luffing Jib No. 149 on Boom No. 82

99 609 kg (219,600 lb) Upperworks Counterweight 36 288 kg (80,000 lb) Carbody Counterweight

360° Rating

kg (lb) x 1 000

65° Boom Angle

73

Luffing Jib Length 21,3 m (70 ft)	Boom m (ft)	24,4 (80)	36,6 (120)	42,7 (140)	54,9 (180)	61,0 (200)
Radius	25,9 (85)	30,7 (67.8)				
	30,0 (90)	25,5 (63.1)				
	32,0 (100)	23,5 (55.3)	21,5 -			
	36,0 (110)	- (48.7)	18,4 (44.7)	17,5 (42.4)		
	40,0 (120)		- (39.9)	15,2 (37.8)	13,2 -	
	44,0 (140)				11,5 (26.6)	10,5 (24.3)
	48,0 (160)					9,2 (19.8)
	52,0 (180)					
	56,0 (200)					
	60,0 (210)					

Luffing Jib Length 36,6 m (120 ft)	Boom m (ft)	24,4 (80)	36,6 (120)	42,7 (140)	54,9 (180)	61,0 (200)
Radius	25,9 (85)					
	30,0 (90)					
	32,0 (100)					
	36,0 (110)	19,4 -				
	40,0 (120)		16,8 (42.0)			
	44,0 (140)		14,8 (34.1)	13,2 (30.5)	12,3 (28.5)	
	48,0 (160)		13,1 (28.2)	11,6 (25.2)	10,9 (23.5)	- (19.6)
	52,0 (180)			10,3 -	9,6 (19.6)	8,0 (16.2)
	56,0 (200)				8,5 -	7,1 (13.4)
	60,0 (210)					6,2 (11.7)
						5,4 (10.6)

Luffing Jib Length 51,8 m (170 ft)	Boom m (ft)	24,4 (80)	36,6 (120)	42,7 (140)	54,9 (180)	61,0 (200)
Radius	46,0 (145)	13,1 (30.7)				
	50,0 (150)	11,6 (29.2)				
	54,0 (160)	10,3 (26.6)	8,9 -	8,2 -		
	58,0 (170)	9,2 (24.3)	7,9 (21.1)	7,2 (19.4)	5,7 -	
	62,0 (190)	8,2 (20.4)	7,0 (17.6)	6,4 (16.1)	5,0 (12.6)	4,2 -
	68,0 (220)		5,9 (13.5)	5,4 (12.3)	4,1 (9.3)	3,3 (7.7)
	74,0 (250)				3,2 (6.7)	2,6 (5.3)
	80,0 (280)					
	84,0 (290)					
	88,0 (295)					

Luffing Jib Length 73,2 m (240 ft)	Boom m (ft)	24,4 (80)	36,6 (120)
Radius	46,0 (145)		
	50,0 (150)		
	54,0 (160)		
	58,0 (170)	7,8 -	
	62,0 (190)	6,9 (17.4)	
	68,0 (220)	5,7 (13.1)	4,5 (10.4)
	74,0 (250)	4,7 (9.7)	3,6 (7.5)
	80,0 (280)	3,6 (5.1)	2,9 (5.1)
	84,0 (290)	2,6 -	2,4 (4.5)
	88,0 (295)		2,0 (4.1)

Meets ANSI B30.5 Requirements - Capacities do not exceed 75% of static tipping load.
NOTICE: This capacity chart is for reference only and must not be used for lifting purposes.

fixed jib on luffing jib range diagram

No. 138 Fixed Jib on No. 135 Luffing Jib on No. 82 or No. 22EL Main Boom

74

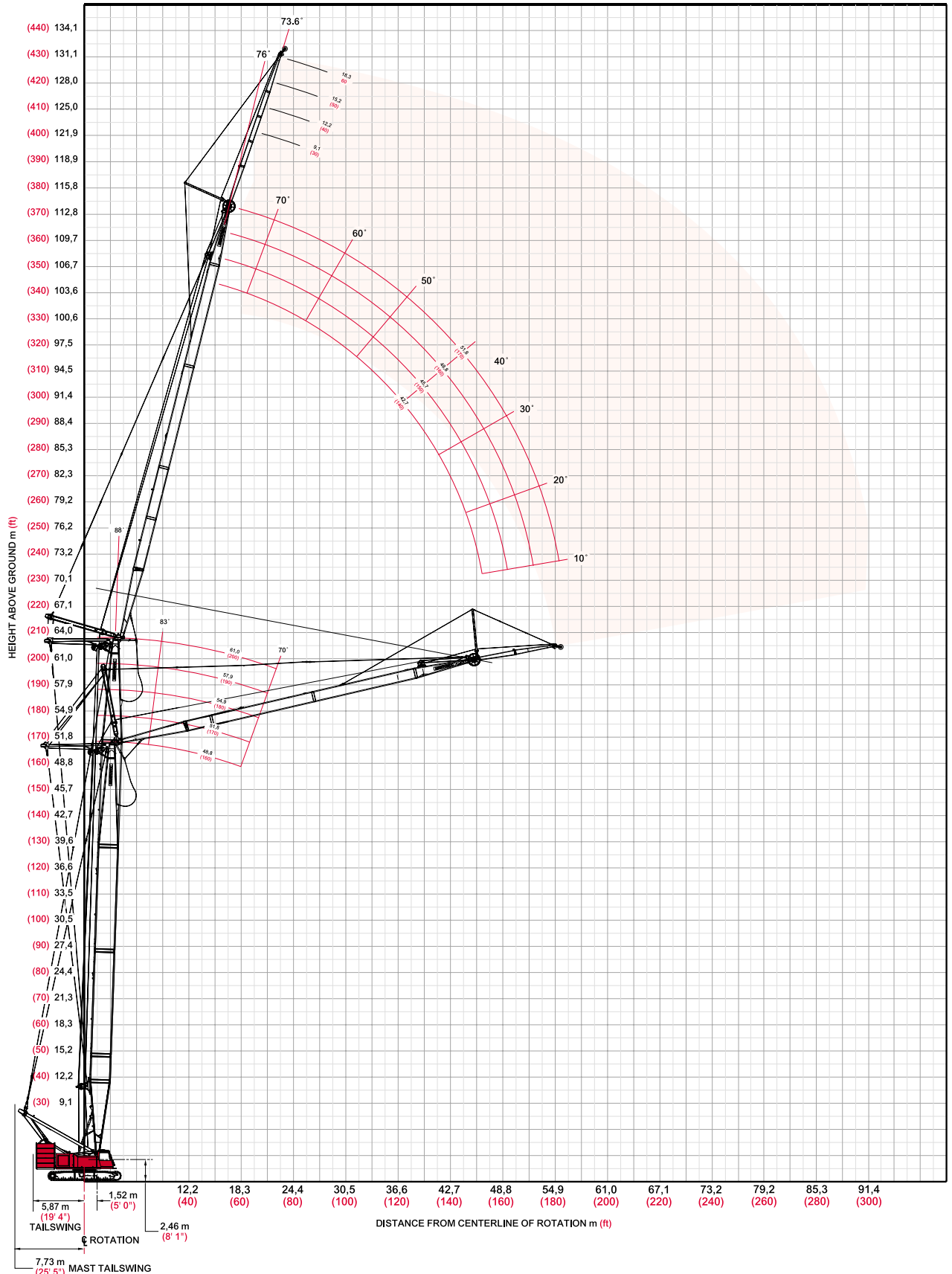

fixed jib on luffing jib load charts

75

Liftcrane Fixed Jib on Luffing Capacities - Series 3

Fixed Jib No. 138 at 3 Degree Angle on Luffing Jib No. 135 on Boom No. 82 or No. 22EL

99 609 kg (219,600 lb) Upperworks Counterweight 36 288 kg (80,000 lb) Carbody Counterweight

360° Rating

kg (lb) x 1 000

88° Boom Angle

Fixed Jib Length 9,1 m (30 ft)	Luffing Jib	42,7 (140)			45,7 (150)			48,8 (160)			51,8 (170)		
	Boom	48,8	54,9	61,0	48,8	54,9	61,0	48,8	54,9	61,0	48,8	54,9	61,0
	m (ft)	(160)	(180)	(200)	(160)	(180)	(200)	(160)	(180)	(200)	(160)	(180)	(200)
Radius													
18,3 (60)	12,4 (27.5)	12,3 (27.2)	12,1 (26.8)	12,2 (27.0)	12,0 (26.6)								
22,0 (70)	12,1 (26.9)	12,0 (26.6)	11,8 (26.3)	11,9 (26.4)	11,7 (26.1)	11,6 (25.7)	11,6 (25.8)	11,3 (25.2)	10,9 (24.4)	10,6 (23.7)	10,2 (22.8)	9,8 (21.7)	
28,0 (90)	11,5 (25.8)	11,5 (25.6)	11,4 (25.3)	11,3 (25.3)	11,3 (25.2)	11,1 (24.8)	11,0 (24.7)	10,9 (24.2)	10,5 (23.3)	10,0 (22.3)	9,7 (21.6)	9,3 (20.8)	
34,0 (110)	10,0 (22.3)	10,0 (22.4)	10,0 (22.4)	9,8 (22.0)	9,8 (22.0)	9,8 (22.0)	9,6 (21.6)	9,7 (21.6)	9,6 (21.5)	9,4 (21.1)	9,3 (20.7)	8,9 (19.9)	
40,0 (130)	8,8 (19.7)	8,9 (19.8)	8,9 (19.9)	8,7 (19.5)	8,7 (19.5)	8,8 (19.6)	8,6 (19.2)	8,6 (19.2)	8,5 (19.1)	8,4 (18.8)	8,4 (18.8)	8,0 (17.9)	
48,0 (150)	7,8 (17.8)	7,8 (17.9)	7,6 (17.9)	7,7 (17.6)	7,7 (17.6)	7,4 (17.4)	7,6 (17.4)	7,5 (17.4)	7,1 (16.7)	7,4 (17.1)	7,2 (16.8)	6,8 (15.9)	
52,0 (170)	7,4 (16.4)	7,2 (16.0)	6,8 (15.2)	7,2 (16.1)	7,0 (15.7)	6,7 (14.9)	7,1 (15.9)	6,8 (15.2)	6,5 (14.5)	6,9 (15.4)	6,6 (14.7)	6,2 (13.9)	
58,0 (190)				- (14.0)	6,0 (13.4)	5,7 (12.8)	6,2 (13.7)	5,9 (13.1)	5,6 (12.5)	6,0 (13.4)	5,7 (12.8)	5,5 (12.2)	
64,0 (220)										5,3 (-)	5,1 (-)	4,8 (-)	
72,0 (240)													

Fixed Jib Length 18,3 m (60 ft)	Luffing Jib	42,7 (140)			45,7 (150)			48,8 (160)			51,8 (170)		
	Boom	48,8	54,9	61,0	48,8	54,9	61,0	48,8	54,9	61,0	48,8	54,9	61,0
	m (ft)	(160)	(180)	(200)	(160)	(180)	(200)	(160)	(180)	(200)	(160)	(180)	(200)
Radius													
18,3 (60)													
22,0 (70)	7,3 (16.4)	7,2 (16.2)	7,1 (15.9)	7,1 (15.8)	7,0 (15.6)	6,9 (15.3)	6,8 (15.2)						
28,0 (90)	6,7 (15.0)	6,7 (14.9)	6,6 (14.7)	6,5 (14.6)	6,5 (14.5)	6,4 (14.3)	6,3 (14.1)	6,2 (13.9)	6,1 (13.7)	6,0 (13.5)	5,9 (13.3)	5,8 (13.1)	
34,0 (110)	6,2 (13.8)	6,1 (13.7)	6,1 (13.6)	6,0 (13.5)	6,0 (13.4)	5,9 (13.2)	5,8 (13.0)	5,8 (12.9)	5,7 (12.8)	5,6 (12.6)	5,6 (12.5)	5,5 (12.2)	
40,0 (130)	5,7 (12.8)	5,7 (12.7)	5,7 (12.8)	5,6 (12.5)	5,6 (12.5)	5,5 (12.3)	5,5 (12.2)	5,4 (12.1)	5,4 (12.0)	5,3 (11.8)	5,2 (11.7)	5,1 (11.5)	
48,0 (150)	5,0 (11.6)	5,0 (11.6)	5,0 (11.6)	4,9 (11.4)	4,9 (11.5)	5,0 (11.5)	4,8 (11.3)	4,9 (11.3)	4,9 (11.3)	4,8 (11.1)	4,8 (11.0)	4,8 (10.9)	
52,0 (170)	4,7 (10.4)	4,7 (10.4)	4,7 (10.5)	4,6 (10.2)	4,6 (10.3)	4,6 (10.3)	4,5 (10.1)	4,6 (10.2)	4,6 (10.2)	4,5 (10.0)	4,5 (10.0)	4,5 (10.0)	
58,0 (190)	4,3 (9.5)	4,3 (9.5)	4,3 (9.5)	4,2 (9.3)	4,2 (9.4)	4,2 (9.4)	4,1 (9.2)	4,2 (9.3)	4,2 (9.3)	4,1 (9.1)	4,1 (9.1)	4,1 (9.1)	
64,0 (220)	3,9 (-)	3,9 (-)	3,9 (-)	3,9 (8.4)	3,9 (8.4)	3,9 (8.4)	3,8 (8.2)	3,8 (8.2)	3,9 (8.3)	3,8 (8.1)	3,8 (8.1)	3,8 (8.1)	
72,0 (240)										3,4 (7.6)	3,4 (7.6)	3,4 (7.6)	

Meets ANSI B30.5 Requirements - Capacities do not exceed 75% of static tipping load.
 NOTICE: This capacity chart is for reference only and must not be used for lifting purposes.

model 999



fixed jib on luffing jib load charts

76

Liftcrane Fixed Jib on Luffing Capacities - Series 3 Fixed Jib No. 138 at 3 Degree Angle on Luffing Jib No. 135 on Boom No. 82 or No. 22EL

99 609 kg (219,600 lb) Upperworks Counterweight 36 288 kg (80,000 lb) Carbody Counterweight

360° Rating

kg (lb) x 1 000

83° Boom Angle

Luffing Jib m (ft)	42,7 (140)			45,7 (150)			48,8 (160)			51,8 (170)		
	48,8 (160)	54,9 (180)	61,0 (200)	48,8 (160)	54,9 (180)	61,0 (200)	48,8 (160)	54,9 (180)	61,0 (200)	48,8 (160)	54,9 (180)	61,0 (200)
Radius												
26,0 (85)	12,2 (27.0)											
28,0 (90)	12,1 (26.8)	12,0 (26.6)	11,8 (26.2)	11,8 (26.2)								
30,0 (95)	12,0 (26.6)	11,9 (26.4)	11,7 (26.0)	11,7 (26.0)	11,6 (25.8)	11,4 (25.4)	11,0 (24.6)	10,7 (23.7)		9,8 (21.9)		
34,0 (110)	11,2 (25.0)	11,4 (25.4)	11,5 (25.5)	10,9 (24.5)	11,1 (24.9)	11,2 (25.0)	10,8 (24.0)	10,4 (23.2)	10,1 (22.3)	9,6 (21.3)	9,3 (20.7)	9,0 (19.9)
38,0 (120)	10,2 (23.3)	10,4 (23.7)	10,5 (24.1)	10,0 (22.9)	10,2 (23.2)	10,3 (23.5)	9,8 (22.4)	10,0 (22.7)	9,9 (22.1)	9,3 (20.9)	9,1 (20.3)	8,8 (19.6)
44,0 (140)	9,0 (20.5)	9,1 (20.8)	9,3 (21.1)	8,9 (20.2)	9,0 (20.5)	9,1 (20.8)	8,7 (19.9)	8,9 (20.2)	9,0 (20.4)	8,6 (19.5)	8,7 (19.7)	8,6 (19.1)
52,0 (170)	7,9 (17.5)	8,0 (17.8)	8,1 (18.0)	7,8 (17.3)	7,9 (17.5)	8,0 (17.7)	7,7 (17.1)	7,8 (17.3)	7,9 (17.5)	7,6 (16.8)	7,6 (17.0)	7,7 (17.2)
60,0 (200)		7,2 (15.9)	7,3 (16.0)	7,0 (15.4)	7,1 (15.5)	7,2 (15.7)	6,9 (15.2)	7,0 (15.4)	7,1 (15.5)	6,8 (15.0)	6,9 (15.1)	6,9 (15.2)
72,0 (230)											- (12.8)	- (13.3)
80,0 (260)												

Fixed Jib Length 9,1 m (30 ft)

Luffing Jib m (ft)	42,7 (140)			45,7 (150)			48,8 (160)			51,8 (170)		
	48,8 (160)	54,9 (180)	61,0 (200)	48,8 (160)	54,9 (180)	61,0 (200)	48,8 (160)	54,9 (180)	61,0 (200)	48,8 (160)	54,9 (180)	61,0 (200)
Radius												
26,0 (85)												
28,0 (90)												
30,0 (95)												
34,0 (110)	6,5 (14.6)	6,4 (14.4)	6,4 (14.3)	6,3 (14.0)	6,3 (14.0)	6,2 (13.9)	6,1 (13.6)	6,0 (13.4)	6,0 (13.3)	5,8 (13.0)	5,7 (12.8)	5,7 (12.6)
38,0 (120)	6,1 (13.9)	6,1 (13.9)	6,1 (13.8)	6,0 (13.5)	6,0 (13.5)	5,9 (13.4)	5,8 (13.1)	5,8 (13.0)	5,7 (12.9)	5,6 (12.6)	5,5 (12.5)	5,4 (12.3)
44,0 (140)	5,7 (12.9)	5,7 (12.9)	5,7 (12.9)	5,6 (12.6)	5,6 (12.6)	5,5 (12.5)	5,5 (12.3)	5,4 (12.2)	5,4 (12.1)	5,3 (11.8)	5,2 (11.7)	5,2 (11.6)
52,0 (170)	5,1 (11.3)	5,1 (11.5)	5,2 (11.7)	5,0 (11.2)	5,1 (11.3)	5,2 (11.5)	4,9 (11.0)	5,0 (11.2)	5,0 (11.2)	4,8 (10.8)	4,8 (10.8)	4,8 (10.8)
60,0 (200)	4,4 (9.7)	4,5 (9.9)	4,6 (10.0)	4,4 (9.6)	4,4 (9.7)	4,5 (9.9)	4,3 (9.5)	4,4 (9.6)	4,4 (9.7)	4,2 (9.3)	4,3 (9.4)	4,4 (9.6)
72,0 (230)		- (8.7)	- (8.8)	- (8.5)	3,8 (8.6)	3,8 (8.7)	3,7 (8.4)	3,7 (8.5)	3,7 (8.6)	3,6 (8.3)	3,7 (8.3)	3,7 (8.4)
80,0 (260)											- (7.6)	- (7.6)

Fixed Jib Length 18,3 m (60 ft)

model 999



Meets ANSI B30.5 Requirements - Capacities do not exceed 75% of static tipping load.
NOTICE: This capacity chart is for reference only and must not be used for lifting purposes.

fixed jib on luffing jib load charts

77

Liftcrane Fixed Jib on Luffing Capacities - Series 3

Fixed Jib No. 138 at 3 Degree Angle on Luffing Jib No. 135 on Boom No. 82 or No. 22EL

99 609 kg (219,600 lb) Upperworks Counterweight 36 288 kg (80,000 lb) Carbody Counterweight

360° Rating

kg (lb) x 1 000

70° Boom Angle

Luffing Jib m (ft)	42,7 (140)			45,7 (150)			48,8 (160)			51,8 (170)		
	48,8 (160)	54,9 (180)	61,0 (200)	48,8 (160)	54,9 (180)	61,0 (200)	48,8 (160)	54,9 (180)	61,0 (200)	48,8 (160)	54,9 (180)	61,0 (200)
Radius												
48,0 (155)	10,3 (23.2)											
50,0 (160)	9,9 (22.5)			9,7 (21.9)								
52,0 (170)	9,5 (21.2)	9,8 (21.9)	9,3 (20.7)	9,4 (20.8)	9,6 (21.4)		8,8 (19.6)					
58,0 (190)	8,6 (19.0)	8,4 (18.7)	7,9 (17.6)	8,4 (18.7)	8,4 (18.6)	7,9 (17.5)	8,3 (18.4)	8,2 (18.2)	7,7 (17.1)	7,6 (16.8)	7,3 (16.2)	6,9 (15.4)
64,0 (210)	7,8 (17.3)	7,3 (16.1)	6,8 (15.1)	7,7 (17.1)	7,2 (16.0)	6,8 (15.0)	7,6 (16.9)	7,0 (15.6)	6,6 (14.6)	7,4 (16.4)	6,9 (15.3)	6,4 (14.3)
72,0 (230)	- (15.0)	6,0 (14.0)	5,6 (13.1)	6,4 (15.0)	6,0 (13.9)	5,6 (13.0)	6,3 (14.6)	5,8 (13.5)	5,4 (12.6)	6,2 (14.4)	5,7 (13.2)	5,3 (12.3)
76,0 (250)					5,4 (12.0)	5,1 (11.2)	5,7 (12.7)	5,3 (11.7)	4,9 (10.9)	5,6 (12.5)	5,2 (11.5)	4,8 (10.6)
84,0 (270)											- (9.9)	- (9.2)
88,0 (290)												
92,0 (300)												

Luffing Jib m (ft)	42,7 (140)			45,7 (150)			48,8 (160)			51,8 (170)		
	48,8 (160)	54,9 (180)	61,0 (200)	48,8 (160)	54,9 (180)	61,0 (200)	48,8 (160)	54,9 (180)	61,0 (200)	48,8 (160)	54,9 (180)	61,0 (200)
Radius												
48,0 (155)												
50,0 (160)												
52,0 (170)												
58,0 (190)	5,3 (11.9)	5,3 (11.9)	5,3 (11.8)	5,2 (11.5)	5,1 (11.4)		4,9 (11.0)	4,9 (10.9)		4,7 (10.5)		
64,0 (210)	5,0 (11.1)	5,1 (11.4)	5,1 (11.4)	4,9 (10.9)	5,0 (11.1)	4,9 (11.0)	4,8 (10.7)	4,8 (10.6)	4,7 (10.5)	4,6 (10.2)	4,5 (10.1)	4,5 (10.0)
72,0 (230)	4,4 (10.1)	4,6 (10.4)	4,7 (10.9)	4,3 (9.9)	4,5 (10.3)	4,6 (10.7)	4,3 (9.8)	4,4 (10.1)	4,6 (10.3)	4,2 (9.6)	4,3 (9.9)	4,3 (9.8)
76,0 (250)	4,1 (9.2)	4,3 (9.5)	4,5 (9.9)	4,1 (9.1)	4,2 (9.4)	4,4 (9.7)	4,0 (9.0)	4,2 (9.3)	4,3 (9.6)	4,0 (8.8)	4,1 (9.1)	4,2 (9.4)
84,0 (270)		- (8.9)	- (9.1)	- (8.5)	3,8 (8.7)	3,9 (8.9)	3,7 (8.3)	3,8 (8.6)	3,9 (8.8)	3,6 (8.2)	3,7 (8.4)	3,8 (8.7)
88,0 (290)								3,6 (8.0)	3,7 (8.2)	3,5 (7.7)	3,5 (7.9)	3,6 (8.1)
92,0 (300)											- (7.7)	3,3 (7.6)

Meets ANSI B30.5 Requirements - Capacities do not exceed 75% of static tipping load.
 NOTICE: This capacity chart is for reference only and must not be used for lifting purposes.

model 999



fixed jib on luffing jib range diagram

PRELIMINARY - CONTACT SALES REPRESENTATIVE FOR CAPACITY CHARTS

No. 134 Fixed Jib on No. 149 Luffing Jib on No. 82 Main Boom

78

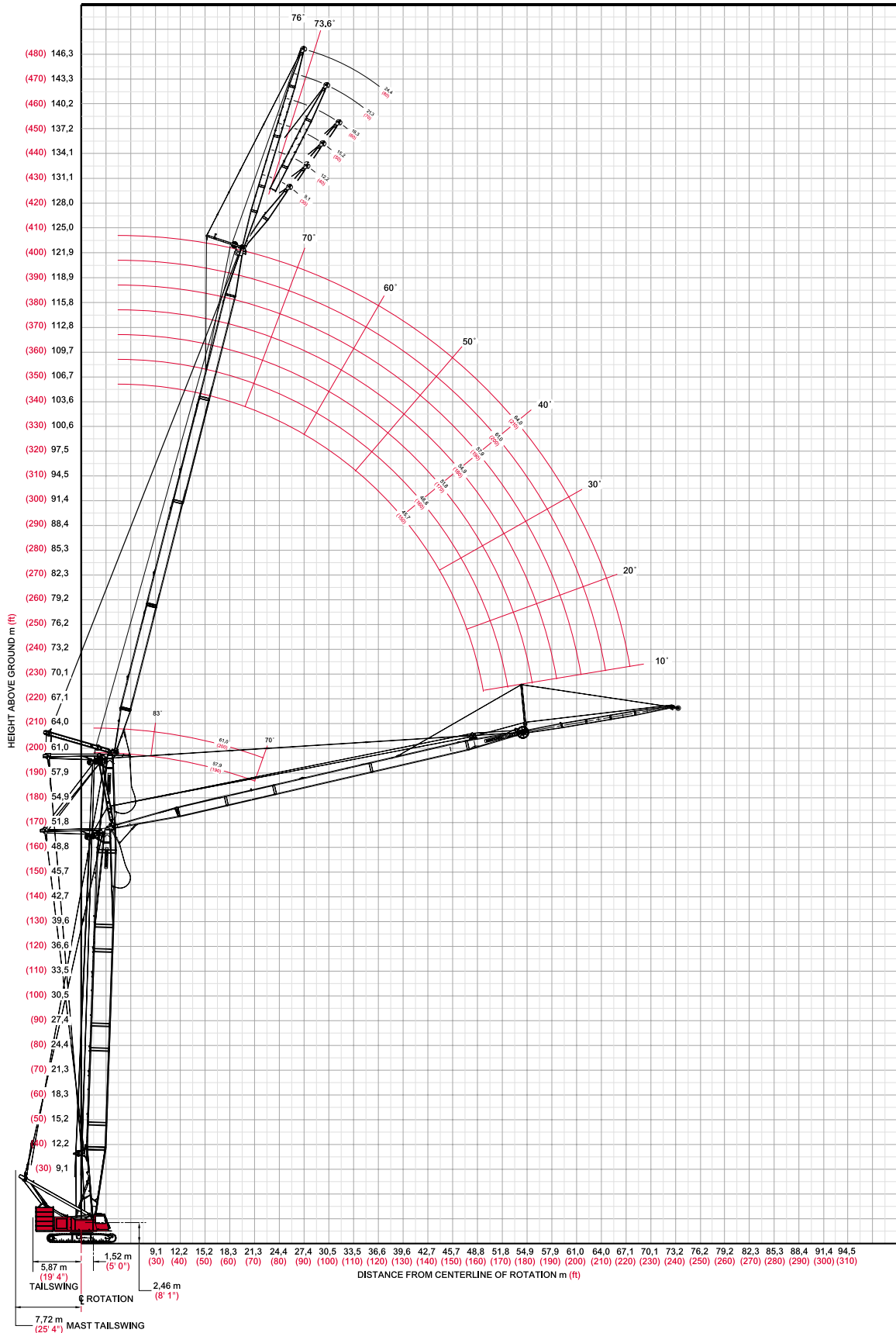

model 999
Manitowoc

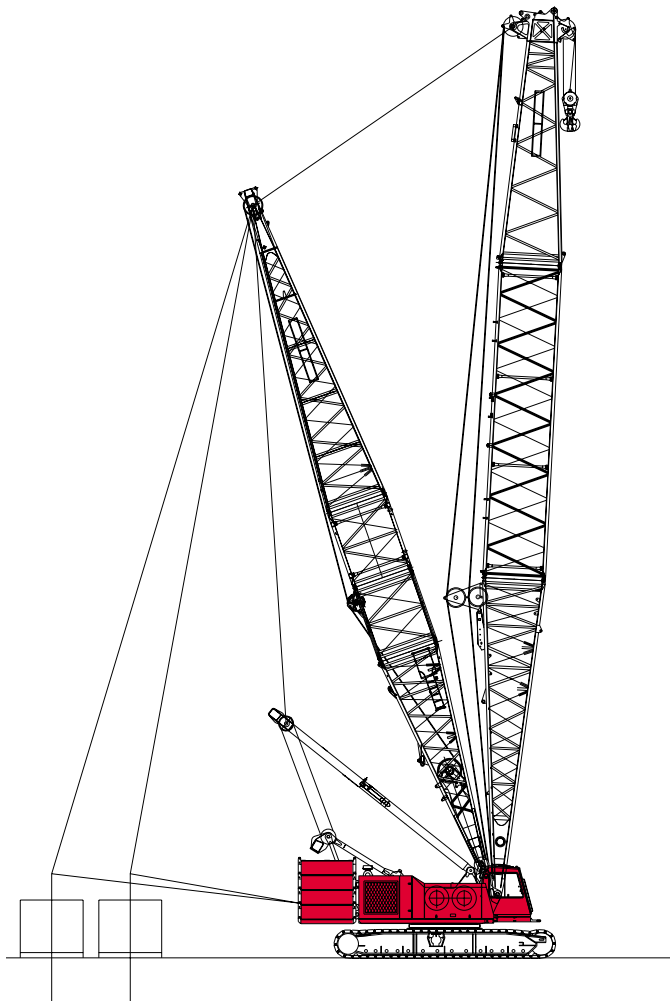

Model 999 MAX-ER
PRELIMINARY

RINGER[®] outline dimensions

80

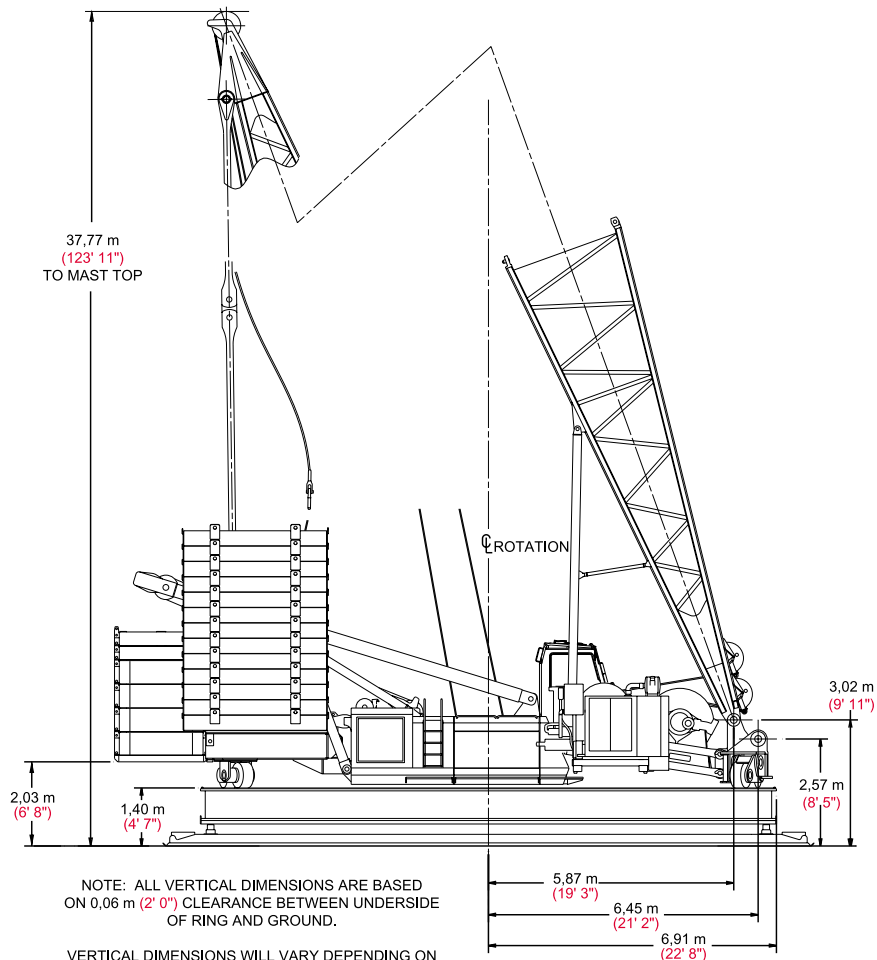
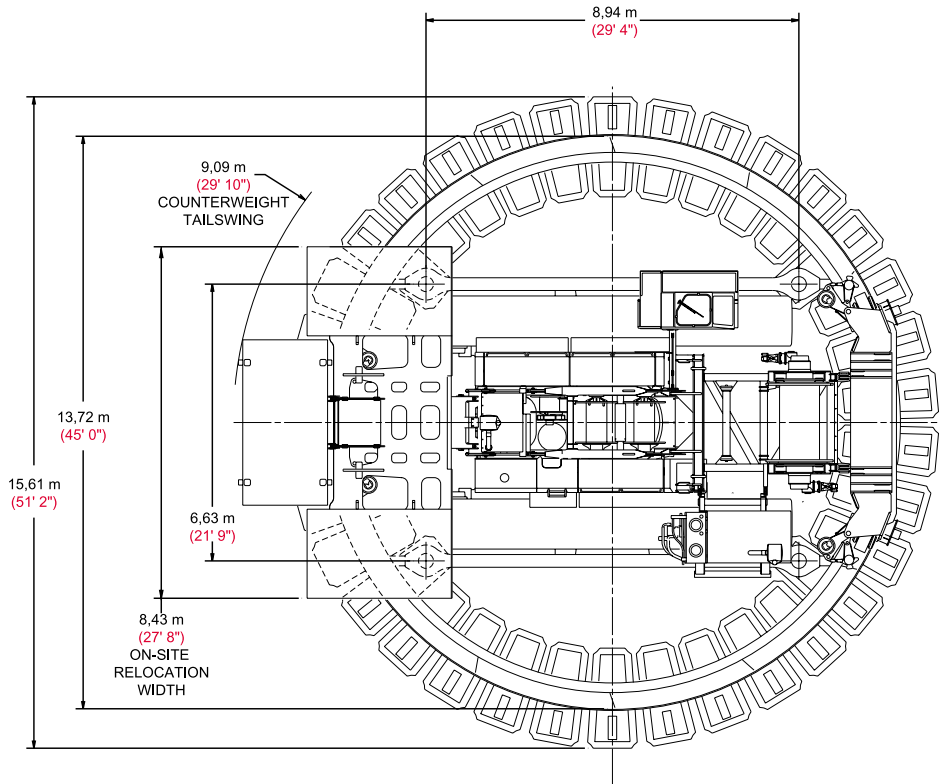

model 999 RINGER[®]



RINGER® combinations

81

No. 67B Boom Combinations

Boom Length m (ft)	Boom Inserts		
	7,6 m (25 ft)	15,2 m (50 ft)	15,2 m* (50 ft)*
38,1 (125)	1	-	-
45,7 (150)	-	1	-
53,3 (175)	1	-	1
61,0 (200)	-	1	1
68,6 (225)	1	1	1
76,2 (250)	-	2	1
83,8 (275)	1	2	1
91,4 (300)	-	3	1
99,1 (325)	1	3	1
106,7 (350)	-	4	1
114,3 (375)	1	4	1
121,9 (400)	-	5	1
129,5 (425)	1	5	1

*15,2 m (50') insert with equalizer storage rails to be used for boom lengths of 53,3 m (175') to 129,5 m (425').

No. 49A/44 Luffing Jib Combinations

Jib Length m (ft)	Luffing Jib Inserts	
	6,1 m (20 ft)	12,2 m (40 ft)
30,5 (100)	-	-
36,6 (120)	1	-
42,7 (140)	-	1
48,8 (160)	1	1
54,9 (180)	-	2
61,0 (200)	1	2
67,1 (220)	-	3
73,2 (240)	1	3
79,2 (260)	-	4
85,3 (280)	1	4
91,4 (300)	-	5
97,5 (320)	1	5

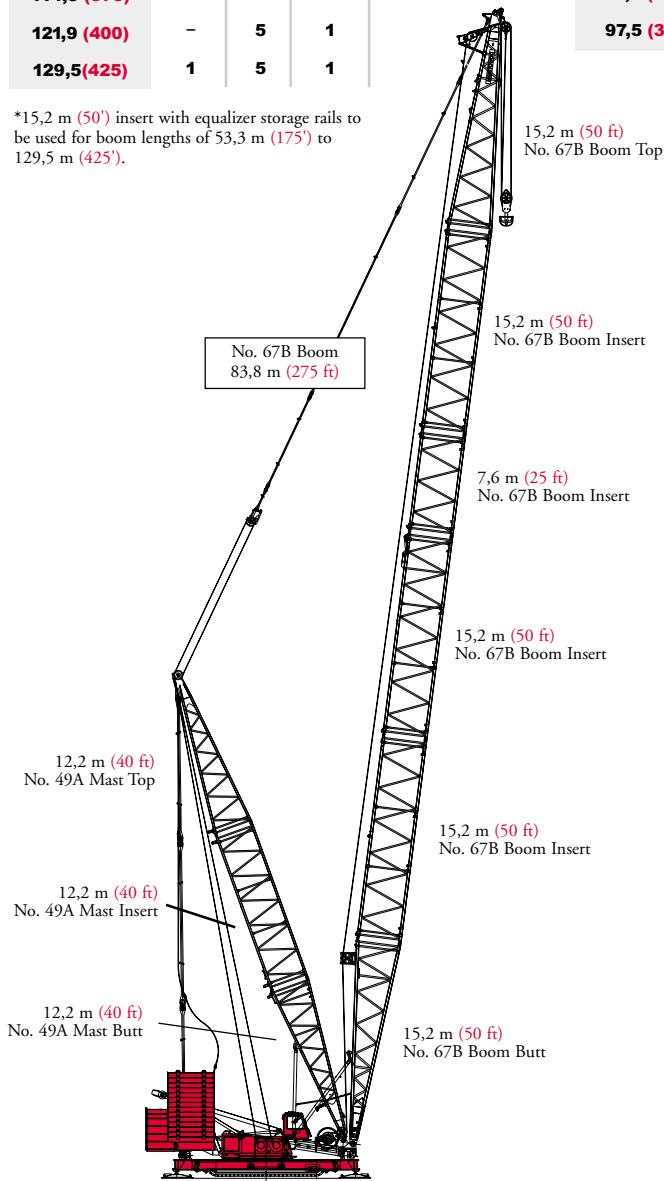

Model 999 RINGER®
No. 67B Boom with No. 49A Mast
Maximum Boom: 129,6 m (425 ft)

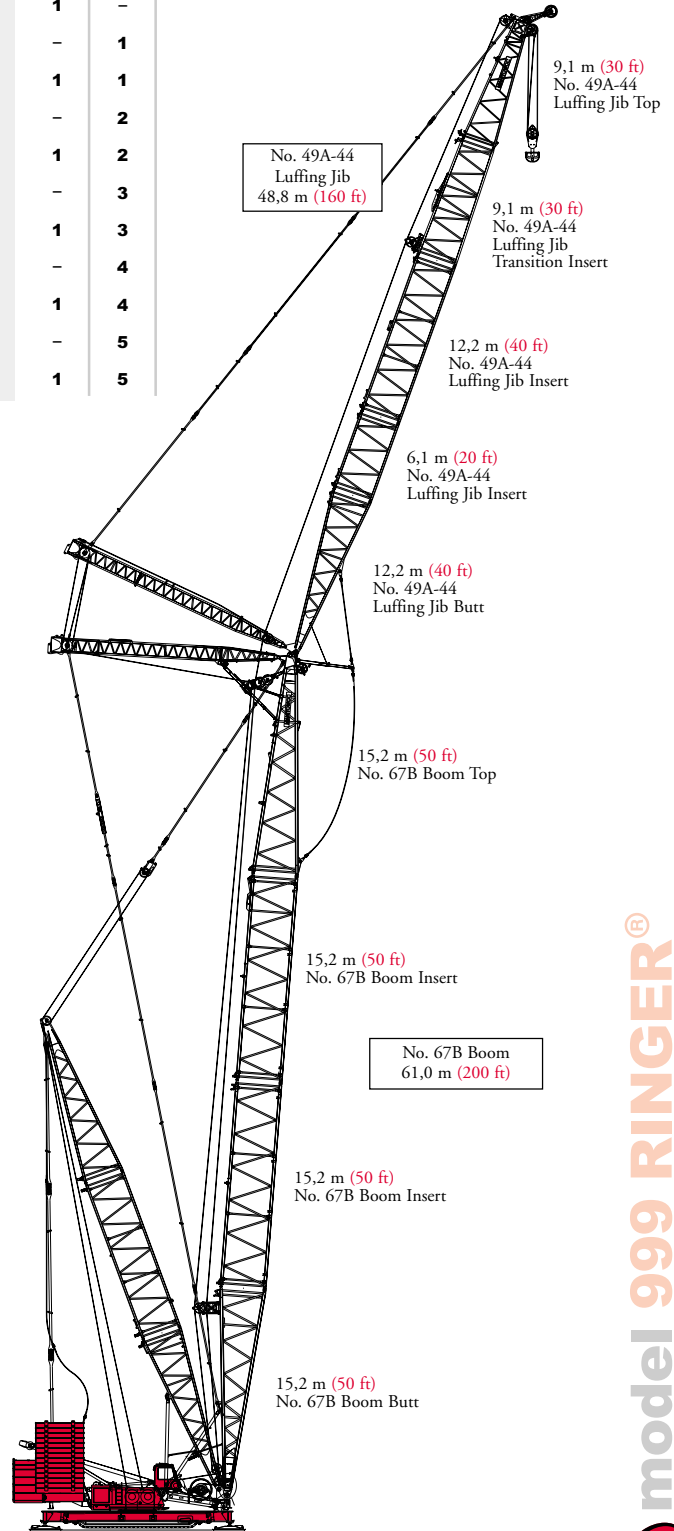

Model 999 RINGER®
No. 49A-44 Luffing Jib on
No. 67B Boom with No. 49A Mast
Maximum Combination: 189,0 m (620 ft)

RINGER[®] heavy-lift range diagram

82

No. 67B Main Boom with No. 49A Mast

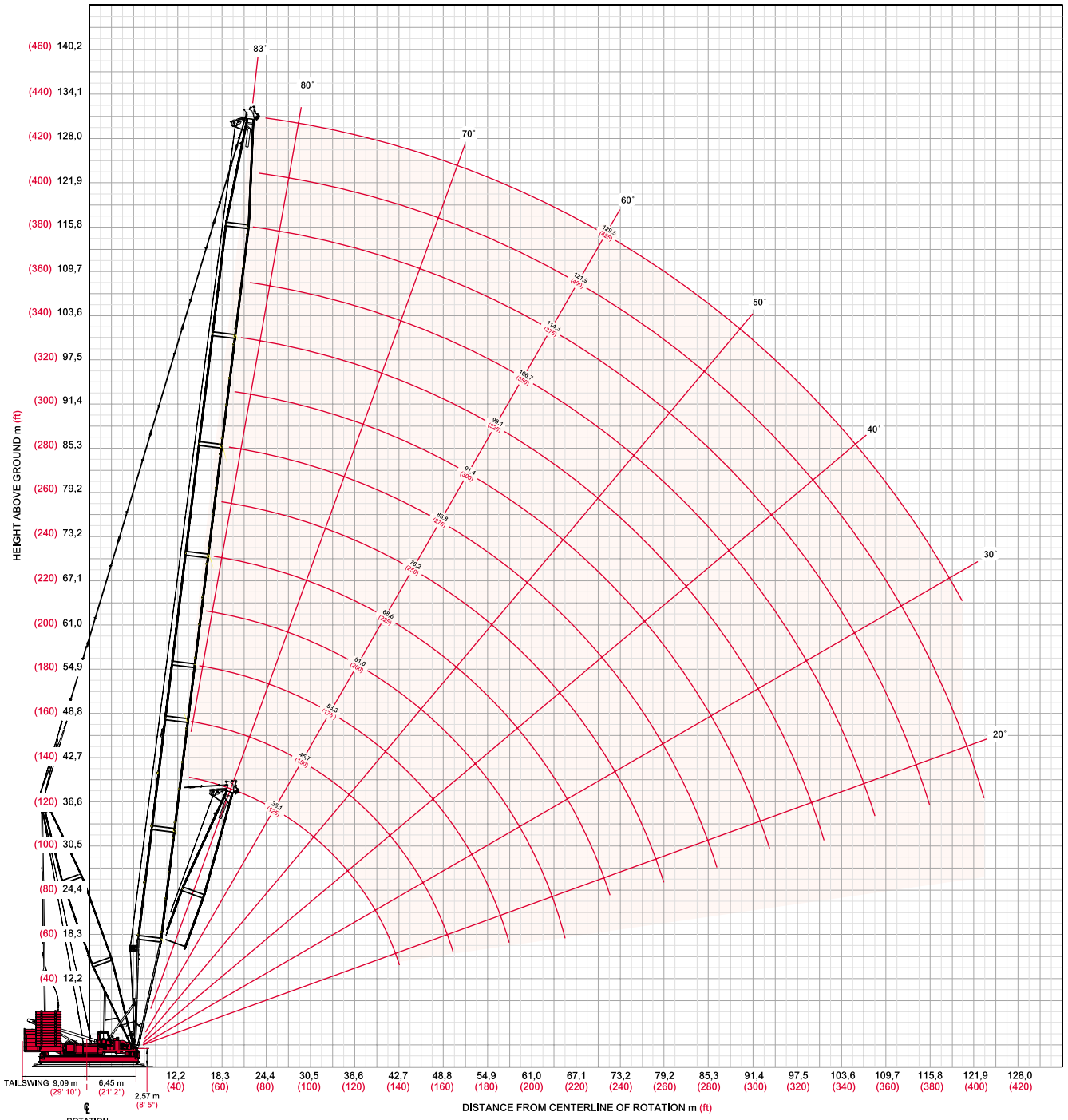

model 999 RINGER[®]
Manitowoc

RINGER® heavy-lift load charts

Liftcrane Boom Capacities
Boom No. 67B with 36,6 m (120') Mast No. 49A
13,7 m (45') RINGER Attachment on Screw Jack Pedestals

632 810 kg (1,395,100 lb) Auxiliary Counterweight

360° Rating

kg (lb) x 1 000

Boom m (ft)	38,1 (125)	45,7 (150)	53,3 (175)	61,0 (200)	68,6 (225)	76,2 (250)	91,4 (300)	99,1 (325)	106,7 (350)	114,3 (375)	121,9 (400)	129,5 (425)
Radius												
12,2 (40)	600,0 (1322.8)											
14,0 (45)	543,2 (1215.5)	537,3 (1200.0)										
16,0 (50)	493,0 (1126.8)	489,1 (1117.3)	478,3 (1077.5)	431,7 (952.7)								
18,0 (60)	450,9 (982.1)	446,9 (973.3)	443,9 (964.6)	426,9 (938.0)	371,1 (816.3)	324,1 (713.4)						
24,0 (80)	357,8 (778.5)	354,3 (770.9)	350,7 (763.0)	346,9 (754.6)	344,4 (746.9)	309,9 (681.4)	242,6 (533.6)	212,9 (469.4)	177,3 (391.0)	148,8 (328.2)	126,0 (277.8)	- (232.7)
30,0 (100)	273,7 (587.1)	277,2 (598.5)	276,1 (595.9)	274,8 (592.7)	273,8 (590.1)	264,3 (572.4)	230,7 (502.8)	208,2 (457.5)	177,3 (391.0)	148,8 (328.2)	126,0 (277.8)	105,5 (232.7)
36,0 (120)	197,6 (422.3)	217,6 (469.9)	216,3 (467.1)	214,9 (464.0)	213,7 (461.3)	212,4 (458.2)	190,5 (413.0)	179,1 (388.3)	168,8 (364.8)	148,8 (328.2)	126,0 (277.8)	105,5 (232.7)
42,0 (140)	137,8 (288.6)	171,8 (367.4)	176,5 (381.2)	175,1 (378.2)	173,9 (375.5)	172,5 (372.4)	161,3 (349.7)	151,9 (329.3)	142,6 (309.1)	134,0 (290.6)	124,7 (272.9)	105,5 (232.7)
50,0 (160)		112,7 (269.7)	137,5 (318.1)	139,0 (316.9)	137,7 (314.1)	136,3 (311.0)	132,8 (301.4)	125,6 (284.7)	117,9 (267.3)	110,7 (251.1)	103,6 (235.1)	96,0 (215.6)
56,0 (180)			104,8 (245.0)	119,4 (270.8)	118,2 (268.0)	116,8 (264.9)	114,1 (259.1)	110,3 (249.1)	103,7 (234.3)	97,4 (220.0)	91,0 (205.6)	85,1 (192.3)
62,0 (200)				95,1 (219.4)	102,8 (232.1)	101,4 (229.0)	98,8 (223.2)	97,4 (219.4)	91,9 (207.0)	86,4 (194.5)	80,6 (181.6)	75,2 (169.4)
68,0 (220)					85,3 (194.9)	89,0 (200.2)	86,3 (194.4)	85,1 (191.7)	81,7 (183.6)	77,0 (172.9)	71,8 (161.3)	66,9 (150.2)
74,0 (240)						75,5 (171.4)	76,1 (170.9)	74,9 (168.1)	72,7 (163.1)	68,7 (154.0)	64,1 (143.7)	59,6 (133.7)
80,0 (260)						- (134.8)	67,5 (151.2)	66,3 (148.4)	64,6 (144.6)	61,3 (137.2)	57,2 (128.1)	53,3 (119.2)
86,0 (280)							58,0 (130.5)	58,7 (131.4)	57,0 (127.5)	54,5 (121.8)	51,0 (114.0)	47,5 (106.1)
92,0 (300)							47,4 (107.0)	50,3 (112.7)	49,8 (111.4)	48,1 (107.5)	45,3 (101.1)	41,3 (92.5)
98,0 (320)								41,6 (93.3)	42,8 (95.6)	42,0 (93.8)	39,9 (88.9)	34,5 (77.3)
104,0 (340)									35,5 (79.4)	36,1 (80.4)	34,6 (77.1)	28,0 (62.8)
110,0 (360)										29,9 (66.6)	29,5 (65.6)	21,8 (48.7)
116,0 (380)										- (50.9)	24,2 (53.8)	15,7 (35.0)
120,0 (390)											20,4 (47.5)	11,7 (28.3)
122,0 (405)											18,3 (36.9)	

Meets ANSI B30.5 Requirements - Capacities do not exceed 75% of static tipping load.
 NOTICE: This capacity chart is for reference only and must not be used for lifting purposes.

RINGER® luffing jib load charts

85

Liftcrane Luffing Jib Capacities

Luffing Jib No. 49A-44 on Boom No. 67B with 36,6 m (120') Mast No. 49A
13,7 m (45') RINGER Attachment on Screw Jack Pedestals

632 810 kg (1,395,100 lb) Auxiliary Counterweight

360° Rating

kg (lb) x 1 000

85° Boom Angle

Boom m (ft)	38,1 (125)	53,3 (175)	68,6 (225)	83,8 (275)	99,1 (325)
Radius					
20,0 (65)	250,0 (551.2)				
22,0 (75)	244,5 (523.4)	240,4 (516.3)	- (448.8)		
26,0 (85)	200,1 (443.8)	197,6 (438.2)	189,2 (418.7)	149,4 (330.3)	115,4 (254.9)
30,0 (100)	156,0 (333.2)	159,5 (343.9)	153,7 (331.7)	131,7 (285.5)	105,2 (229.0)
36,0 (120)	106,6 (226.4)	116,7 (248.2)	121,1 (262.1)	104,8 (225.9)	87,7 (189.7)
42,0 (140)			82,1 (165.4)	83,9 (181.3)	72,4 (156.6)
50,0 (160)					
56,0 (180)					
60,0 (200)					
68,0 (230)					

Boom m (ft)	38,1 (125)	53,3 (175)	68,6 (225)	83,8 (275)	99,1 (325)
Radius					
20,0 (65)					
22,0 (75)					
26,0 (85)	180,7 (399.7)				
30,0 (100)	157,4 (341.5)	155,9 (339.7)	123,2 (269.2)	- (211.9)	
36,0 (120)	116,9 (250.7)	125,2 (268.1)	106,3 (230.6)	85,9 (186.9)	68,5 (149.4)
42,0 (140)	88,9 (190.6)	94,6 (202.6)	87,9 (189.4)	73,2 (158.3)	59,8 (129.9)
50,0 (160)	63,8 (148.1)	67,7 (157.0)	66,6 (153.4)	57,4 (131.6)	48,5 (110.6)
56,0 (180)	49,6 (115.0)	52,9 (122.4)	54,4 (124.6)	47,9 (109.3)	41,2 (93.8)
60,0 (200)	41,1 (86.0)	44,2 (93.1)	47,1 (99.3)	42,7 (91.8)	37,2 (80.2)
68,0 (230)				31,7 (70.0)	31,4 (63.0)

Boom m (ft)	38,1 (125)	53,3 (175)	68,6 (225)	83,8 (275)	91,4 (300)
Radius					
34,0 (110)	109,6 (242.6)				
38,0 (120)	96,9 (225.9)	86,1 (193.0)	69,8 (156.2)		
42,0 (140)	82,9 (178.1)	81,6 (178.1)	66,4 (145.0)	53,1 (116.2)	47,2 (103.2)
50,0 (160)	59,5 (137.9)	62,4 (144.8)	57,7 (130.4)	46,7 (105.5)	41,7 (94.1)
58,0 (190)	43,6 (96.5)	45,5 (100.8)	46,9 (103.9)	39,7 (87.8)	35,7 (78.9)
68,0 (220)	30,0 (68.6)	31,3 (71.6)	32,3 (73.9)	31,7 (71.5)	28,7 (64.8)
76,0 (250)	22,3 (49.0)	23,3 (51.2)	24,2 (53.0)	25,1 (55.0)	24,1 (53.0)
84,0 (280)	16,3 (33.5)	17,1 (35.7)	17,9 (37.5)	18,7 (39.3)	19,2 (40.4)
92,0 (300)	9,0 (21.3)	10,6 (24.6)	11,8 (27.2)	13,0 (29.9)	13,4 (30.8)
96,0 (320)			7,8 (16.7)	9,3 (16.7)	9,7 (18.0)

Boom m (ft)	38,1 (125)	53,3 (175)	68,6 (225)	83,8 (275)	91,4 (300)
Radius					
34,0 (110)					
38,0 (120)	84,6 (188.4)				
42,0 (140)	75,1 (161.5)	68,1 (149.2)	55,5 (121.8)	44,2 (97.1)	39,0 (85.7)
50,0 (160)	54,6 (126.8)	56,9 (131.8)	50,6 (113.6)	40,5 (90.9)	35,8 (80.4)
58,0 (190)	39,3 (87.0)	40,9 (90.7)	42,5 (94.1)	35,8 (79.1)	31,7 (70.2)
68,0 (220)	26,1 (60.0)	27,3 (62.6)	28,4 (65.1)	29,6 (66.6)	26,4 (59.4)
76,0 (250)	18,3 (40.1)	19,4 (42.5)	20,4 (44.7)	21,8 (47.7)	21,9 (47.9)
84,0 (280)	11,9 (24.1)	12,8 (26.3)	13,8 (28.4)	15,0 (30.9)	15,2 (31.5)
92,0 (300)		- (15.0)	- (18.3)	8,9 (21.0)	9,4 (22.0)
96,0 (320)					

Meets ANSI B30.5 Requirements - Capacities do not exceed 75% of static tipping load.
NOTICE: This capacity chart is for reference only and must not be used for lifting purposes.

RINGER® luffing jib load charts

86

Liftcrane Luffing Jib Capacities
Luffing Jib No. 49A-44 on Boom No. 67B with 36,6 m (120') Mast No. 49A
13,7 m (45') RINGER Attachment on Screw Jack Pedestals

632 810 kg (1,395,100 lb) Auxiliary Counterweight

360° Rating

kg (lb) x 1 000

70° Boom Angle

Luffing Jib Length	30,5 m (100 ft)					Luffing Jib Length	54,9 m (180 ft)					
	Boom m (ft)	38,1 (125)	53,3 (175)	68,6 (225)	83,8 (275)		99,1 (325)	Boom m (ft)	38,1 (125)	53,3 (175)	68,6 (225)	83,8 (275)
Radius	38,0 (120)	177,1 (426.9)				38,0 (120)						
40,0 (130)	157,9 (355.5)					40,0 (130)						
46,0 (150)	114,5 (256.8)	151,9 (339.0)				46,0 (150)						
52,0 (170)		109,7 (244.7)	123,8 (274.4)	106,5 (235.9)		52,0 (170)	91,5 (203.2)					
58,0 (190)			104,6 (231.8)	92,3 (203.9)	77,6 (171.6)	58,0 (190)	73,1 (161.9)	89,8 (198.8)				
64,0 (210)				80,6 (177.8)	67,9 (149.7)	64,0 (210)	58,2 (128.4)	71,2 (157.0)	86,9 (191.6)	- (159.6)		
72,0 (230)					- (131.0)	72,0 (230)	41,3 (100.1)	52,5 (124.7)	64,1 (152.0)	61,0 (140.0)	48,9 (112.4)	
80,0 (260)						80,0 (260)		- (80.9)	46,7 (106.5)	52,1 (116.6)	41,3 (92.6)	
88,0 (290)						88,0 (290)				40,8 (88.2)	35,1 (76.9)	
92,0 (310)						92,0 (310)					32,3 (67.6)	

Luffing Jib Length	85,3 m (280 ft)					Luffing Jib Length	97,5 m (320 ft)					
	Boom m (ft)	38,1 (125)	53,3 (175)	68,6 (225)	83,8 (275)		91,4 (300)	Boom m (ft)	38,1 (125)	53,3 (175)	68,6 (225)	83,8 (275)
Radius	50,0 (160)					50,0 (160)						
56,0 (180)						56,0 (180)						
64,0 (200)						64,0 (200)						
72,0 (230)	37,6 (89.0)	45,5 (107.8)				72,0 (230)	33,4 (79.6)					
80,0 (260)	28,1 (63.7)	33,9 (76.8)	40,3 (91.5)	42,4 (95.2)		80,0 (260)	24,0 (54.7)	29,6 (67.5)				
88,0 (290)	20,8 (45.4)	25,3 (55.1)	30,2 (65.8)	35,6 (77.9)	30,3 (66.4)	88,0 (290)	16,6 (36.0)	21,1 (45.9)	26,2 (57.0)	31,6 (69.1)	- (57.3)	
96,0 (310)	15,0 (35.3)	18,6 (43.8)	22,5 (52.7)	27,1 (63.2)	25,2 (57.6)	96,0 (310)	10,5 (25.6)	14,3 (34.3)	18,6 (43.9)	23,6 (55.6)	21,2 (48.8)	
104,0 (340)	9,8 (22.7)	13,2 (29.7)	16,5 (37.1)	20,2 (45.3)	20,8 (46.4)	104,0 (340)		8,7 (19.7)	12,2 (27.7)	16,5 (37.1)	17,0 (37.9)	
112,0 (370)			11,5 (24.5)	14,6 (31.3)	16,5 (35.3)	112,0 (370)				10,5 (22.1)	12,2 (25.9)	
120,0 (390)				9,5 (23.5)	11,5 (26.8)	120,0 (390)					- (17.1)	

model 999 RINGER®

Meets ANSI B30.5 Requirements - Capacities do not exceed 75% of static tipping load.
 NOTICE: This capacity chart is for reference only and must not be used for lifting purposes.

RINGER® luffing jib load charts

Liftcrane Luffing Jib Capacities
Luffing Jib No. 49A-44 on Boom No. 67B with 36,6 m (120') Mast No. 49A
13,7 m (45') RINGER Attachment on Screw Jack Pedestals

632 810 kg (1,395,100 lb) Auxiliary Counterweight

360° Rating

kg (lb) x 1 000

60° Boom Angle

Boom m (ft)	38,1 (125)	53,3 (175)	68,6 (225)	83,8 (275)	99,1 (325)
Luffing Jib Length 30,5 m (100 ft)					
Radius					
50,0 (160)	130,7 (304.9)				
56,0 (180)	92,9 (223.3)	113,1 (225.8)			
60,0 (200)		103,7 (224.0)			
68,0 (220)			82,1 (184.5)		
72,0 (240)				65,4 (141.1)	
80,0 (260)				- (125.0)	44,9 (100.5)
88,0 (290)					
96,0 (310)					
100,0 (330)					
108,0 (350)					

Boom m (ft)	38,1 (125)	53,3 (175)	68,6 (225)	83,8 (275)	99,1 (325)
Luffing Jib Length 54,9 m (180 ft)					
Radius					
50,0 (160)					
56,0 (180)					
60,0 (200)					
68,0 (220)	64,6 (147.1)				
72,0 (240)	56,4 (119.3)	74,4 (156.9)			
80,0 (260)	39,7 (91.8)	55,8 (126.6)	58,8 (131.6)		
88,0 (290)		38,9 (83.3)	50,9 (111.5)	40,6 (89.0)	
96,0 (310)			37,8 (92.4)	35,0 (79.5)	24,9 (56.6)
100,0 (330)				32,5 (70.9)	22,9 (49.9)
108,0 (350)					19,2 (43.7)

Boom m (ft)	38,1 (125)	53,3 (175)	68,6 (225)	83,8 (275)	91,4 (300)
Luffing Jib Length 85,3 m (280 ft)					
Radius					
64,0 (210)					
68,0 (230)					
76,0 (250)					
84,0 (280)	30,4 (63.9)				
96,0 (310)	19,4 (45.6)	25,9 (60.5)			
104,0 (340)	13,8 (31.0)	19,2 (43.0)	25,3 (56.6)		
112,0 (370)		13,6 (29.0)	18,8 (40.2)	16,8 (36.4)	12,1 (26.2)
120,0 (400)			13,4 (27.0)	13,6 (28.5)	9,3 (19.2)
128,0 (420)				10,8 (23.8)	6,8 (15.0)
132,0 (440)					9,3 (19.0)

Boom m (ft)	38,1 (125)	53,3 (175)	68,6 (225)	83,8 (275)
Luffing Jib Length 97,5 m (320 ft)				
Radius				
64,0 (210)				
68,0 (230)				
76,0 (250)				
84,0 (280)				
96,0 (310)	15,1 (36.1)			
104,0 (340)	9,3 (21.1)	14,8 (33.4)		
112,0 (370)		9,1 (19.0)	14,5 (30.8)	- (27.3)
120,0 (400)			8,9 (17.1)	9,6 (19.7)
128,0 (420)				6,9 (15.3)
132,0 (440)				

Meets ANSI B30.5 Requirements - Capacities do not exceed 75% of static tipping load.
 NOTICE: This capacity chart is for reference only and must not be used for lifting purposes.



CraneCARE is Manitowoc's comprehensive service and support program. It includes classroom and on-site training, prompt parts availability, expert field service, technical support and documentation — for every one of the more than 7,000 Manitowoc cranes currently in use throughout the world.

That's commitment you won't find anywhere else.

That's **CraneCARE**.

Service Training

Manitowoc specialists work with you in our training center and in the field to make sure you know how to get maximum performance, reliability, and life from your cranes.

Manitowoc Cranes Technical Training Center provides valuable multi-level training, which is available for all models and attachments, in the following format:

- **Basic** – Provides technicians with the basic skills required in our Level I and II classes covering hydraulic and electrical theory and schematics, pump, motor, control, and LMI operation, and the use of meters and gauges.
- **Level 1** – This model-specific class covers theory and offers hands-on training and trouble shooting for all crane systems.
- **Level 2** – This model-specific class provides in depth coverage of all crane systems and components, and advanced troubleshooting of simulated faults. (Requires Level 1.)
- **Level 3/Master** – Covering all EPIC models and the 4100W, this class stresses high level system knowledge and trouble shooting of simulated faults. (Requires Level 2.)

Parts Availability

Genuine Manitowoc replacement parts are accessible through your distributor 24 hours a day, 7 days a week, 365 days a year.

Service Interval Kits

Provides all the parts required by Manitowoc's Preventative Maintenance Checklist.

Hydraulic Filter Kit – Part No. 495136-0

Consists of the following:

- Filter Element - No substitutions allowed (1x Part No. 427283-0)
- Spin-on Filter Element (3x Part No. 427282-0)

Caterpillar Model 3176C Diesel – Part No. 414172-0

Service Interval Kits

200 Hour Kit – Part No. 495117-0

Consists of the following:

Engine

- Air Cleaner - Disposable (1x Part No. 347066-0)
- Oil Filter (1x Part No. 413202-0)
- Water Filter (1x Part No. 413635-0)
- Fuel Filter - Final (1x Part No. 413636-0)
- Fuel Filter - Primary (1x Part No. 413637-0)

1,000 Hour Kit – Part No. 495118-0

Consists of the following:

Engine

- Air Cleaner - Disposable (1x Part No. 347066-0)
- Oil Filter (1x Part No. 413202-0)
- Water Filter (1x Part No. 413635-0)
- Fuel Filter - Final (1x Part No. 413636-0)
- Fuel Filter - Primary (1x Part No. 413637-0)

Hydraulic

- Filter Element - No substitutions allowed (1x Part No. 427283-0)
- Spin-on Filter Element (3x Part No. 427282-0)

2,000 Hour Kit – Part No. 495119-0

Consists of the following:

Engine

- Air Cleaner - Disposable (1x Part No. 347066-0)
- Oil Filter (1x Part No. 413202-0)
- Water Filter (1x Part No. 413635-0)
- Fuel Filter - Final (1x Part No. 413636-0)
- Fuel Filter - Primary (1x Part No. 413637-0)
- Fan Belt Set (1x Part No. 413638-0)
- Hose - Lower Coolant (1x Part No. 413639-0)

Hydraulic

- Filter Element - No substitutions allowed (1x Part No. 427283-0)
- Spin-on Filter Assembly and Manifold (1x Part No. 427302-0)
- Spin-on Filter Element (3x Part No. 427282-0)
- Relief Valve Cartridge (1x Part No. 427302-6)
- Spin-on Filter Assembly and Head (1x Part No. 427278-0)
- Cartridge Seal Kit (1x Part No. 427302-5)

Hydraulic for free-fall

- Spin-on Filter Assembly and Manifold (1x Part No. 427296-0)
- Filter Element - No substitutions allowed (2x Part No. 427282-0)

Cummins Model QSM11 Diesel – Part No. 414173-0

Service Interval Kits

200 Hour Kit – Part No. 495191-0

Consists of the following:

Engine

- Air Cleaner - Disposable (1x Part No. 347066-0)
- Oil Filter (1x Part No. 413648-0)
- Water Filter (1x Part No. 413649-0)
- Fuel Filter - Primary (1x Part No. 413647-0)

1,000 Hour Kit – Part No. 495192-0

Consists of the following:

Engine

- Air Cleaner - Disposable (1x Part No. 347066-0)
- Oil Filter (1x Part No. 413648-0)
- Water Filter (1x Part No. 413649-0)
- Fuel Filter - Primary (1x Part No. 413647-0)

Hydraulic

- Filter Element - No substitutions allowed (1x Part No. 427283-0)
- Spin-on Filter Element (3x Part No. 427282-0)

2,000 Hour Kit – Part No. 495193-0

Consists of the following:

Engine

- Air Cleaner - Disposable (1x Part No. 347066-0)
- Oil Filter (1x Part No. 413648-0)
- Water Filter (1x Part No. 413649-0)
- Fuel Filter - Primary (1x Part No. 413647-0)
- Fan Belt - Alternator (1x Part No. 413645-0)
- Fan Belt - Fan (1x Part No. 413646-0)

Hydraulic

- Spin-on Filter Assembly and Head (1x Part No. 427278-0)
- Filter Element - No substitutions allowed (1x Part No. 427283-0)
- Spin-on Filter Assembly and Manifold (1x Part No. 427302-0)
- Spin-on Filter Element (3x Part No. 427282-0)
- Relief Valve Cartridge (1x Part No. 427302-6)
- Cartridge Seal Kit (1x Part No. 427302-5)

Hydraulic for free-fall

- Spin-on Filter Assembly and Manifold (1x Part No. 427296-0)
- Filter Element - No substitutions allowed (2x Part No. 427282-0)

Hydraulic Test Kit – Part No. 499791-6

Protect your investment by demanding Genuine Manitowoc Parts Service Kits. The Hydraulic Service Kit consist of the following:

- All hydraulic fittings to access all pressures and flows
- Hydraulic flow meters and pressure gauges to record hydraulic data.
- Electrical “Break out” harnesses to access voltages on all electrical circuits on all machines.
- Fluke® Digital volt ohm meter, as used in all Manitowoc service literature.

Hydraulic Test Kit with case – Part No. 499792-9

The above kit (Part No. 4299791-6) plus a custom heavy-duty carrying case.

U.S. Standard Tools Kit – Part No. 499976-0

All standard tools needed to properly maintain and service your crane. (Does not include torque wrench.)

Field Service

Factory-trained service experts are always ready to help maintain your crane's peak performance.

For a worldwide listing of dealer locations, please consult our website at: www.manitowoccranes.com

Technical Support

Manitowoc's dealer network and factory personnel are available 24 hours a day, 7 days a week, 365 days a year to answer your technical questions and more, with the help of computerized programs that simplify crane selection, lift planning, and ground-bearing calculations.

For a worldwide listing of dealer locations, please consult our website at: www.manitowoccranes.com

Technical Documentation

Manitowoc has the industry's most extensive documentation, and the easiest to understand, available in major languages and formats that include print, disk, and videotape.

A complete set of Operator's, Parts, Capacity, Vendor, and Service Technician's Manuals are shipped with each crane.

Additional copies available through your Authorized Manitowoc Distributor.

- **Crane Operator's Manual – Part No. 899721**
- **Crane Parts Manual – Part No. 899720**
- **Crane Capacity Manual – Part No. 899730**
- **Crane Vendor Manual – Part No. 899722**
- **Service Technician's Manual (EPIC) – Part No. 899732**
- **Luffing Jib Operator's/Parts Manual – Part No. 899726**
- **Capacity Chart Manual - Attachments – Part No. 899795**

CD rom versions of the Operator's and Parts Manuals are shipped with each crane.

CraneCARESM

90

Also available are the following CDs:

- **999 Service – Yearly subscription (Distributors)**
CD – Part No. 899808
- **Owner Master CD (specify crane serial number)**
CD – Part No. 899810
- **Ground Bearing Pressure Estimator**
CD – Part No. 899765
- **Crane Selection and Planning Software (CompuCRANE®)**
CD – Part No. 899766

- **EPIC® Crane Library** consisting of capacity charts, range diagrams, wire rope specifications, travel specifications, crane weights, counterweight arrangements, luffing jib raising procedures, operating range diagrams, drum and lagging charts, boom rigging drawings, jib rigging drawings, outline dimensions, and wind condition charts.

CD – Part No. 899801

Available from your Authorized Manitowoc Cranes Distributor, these VHS videos are available in NTSC, PAL and SECAM formats.

- **Model 999 Assembly Video – Part No. 899805**
- **Model 999 Operation Video – Part No. 899806**
- **Model 999 Lubrication Video – Part No. 899807**
- **Your Capacity Chart Video – Part No. 899737**
- **Respect the Limits Video – Part No. 899734**
- **Crane Safety Video – Part No. 899736**
- **Boom Inspection/Repair Video – Part No. 899738**

CraneCARE Package

Manitowoc has assembled all of the available literature, CD's, and videos listed above plus several Manitowoc premiums into one complete CraneCARE Package.

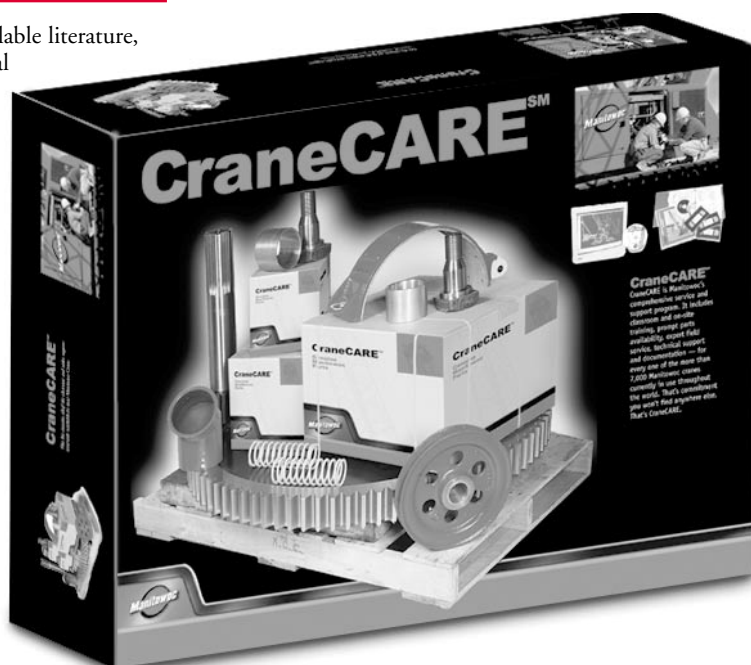

A large rectangular area filled with a fine grid pattern, intended for taking notes. The grid consists of small squares and covers most of the page's width and height.



Manitowoc Cranes, Inc.
P.O. Box 70
Manitowoc, WI, USA 54221-0070
Telephone 920-684-6621
Facsimile 920-683-6277
www.manitowoccranes.com

Backed by Manitowoc

CraneCARESM

CraneCARE is Manitowoc's comprehensive service and support program. It includes classroom and on-site training, prompt parts availability, expert field service, technical support and documentation — for every one of the more than 7,000 Manitowoc cranes currently in use throughout the world. That's commitment you won't find anywhere else. That's CraneCARE.