

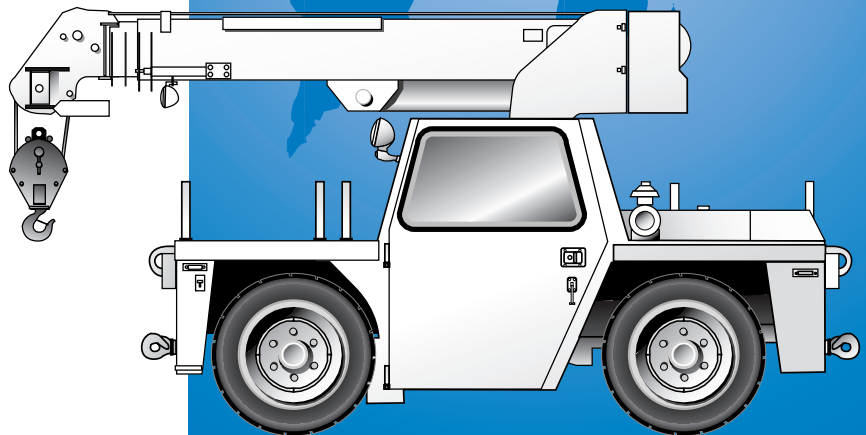

GROVE[®]
CRANE

A GROVE WORLDWIDE COMPANY

AP206



Material Handling Hydraulic Crane

Dimensions

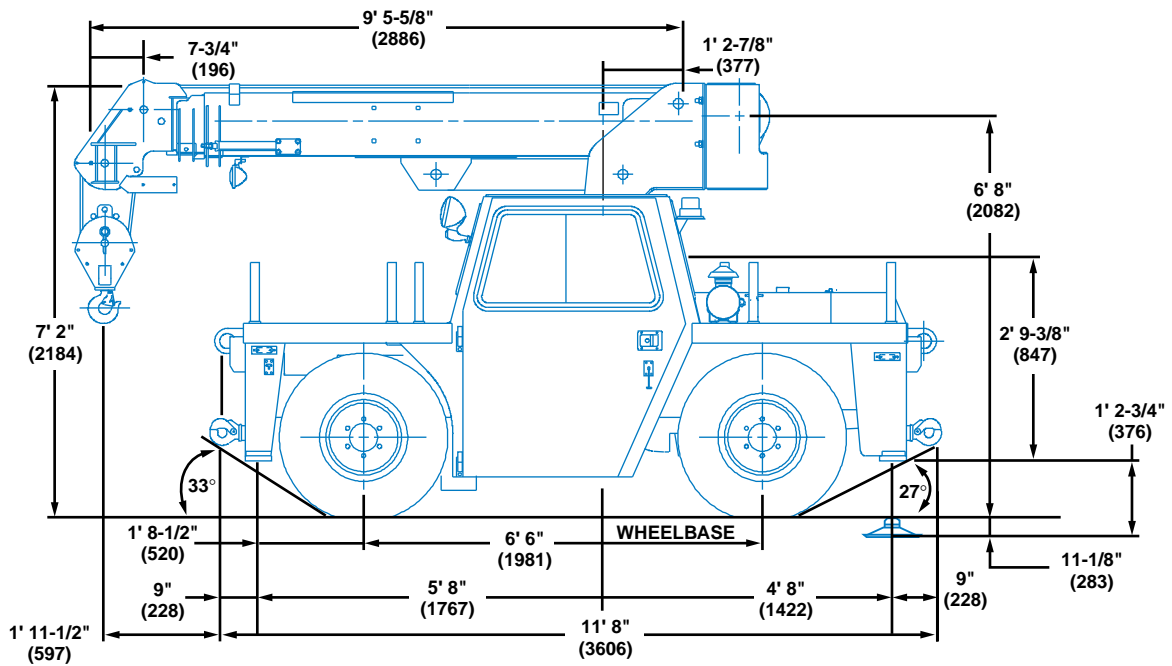
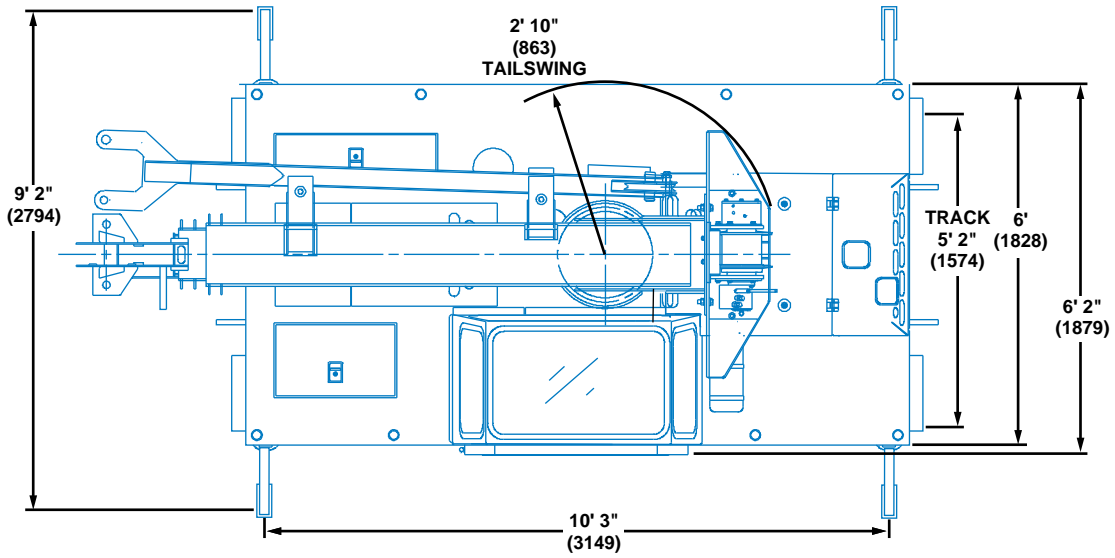

Note: () Reference dimensions in mm

- Turning Radius** 13' 6" (4137 mm)
- Front Axle Load** 5,250 lbs. (2380 kg)
- Rear Axle Load** 5,825 lbs. (2642 kg)
- Gross Vehicle Weight** 11,075 lbs. (5023 kg)

Working Range



9.5 - 20 ft.
(2.9 - 6.1 m)

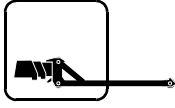

9 ft.
(2.74 m)

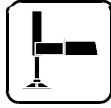

360°

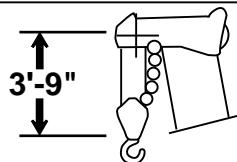
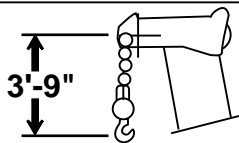
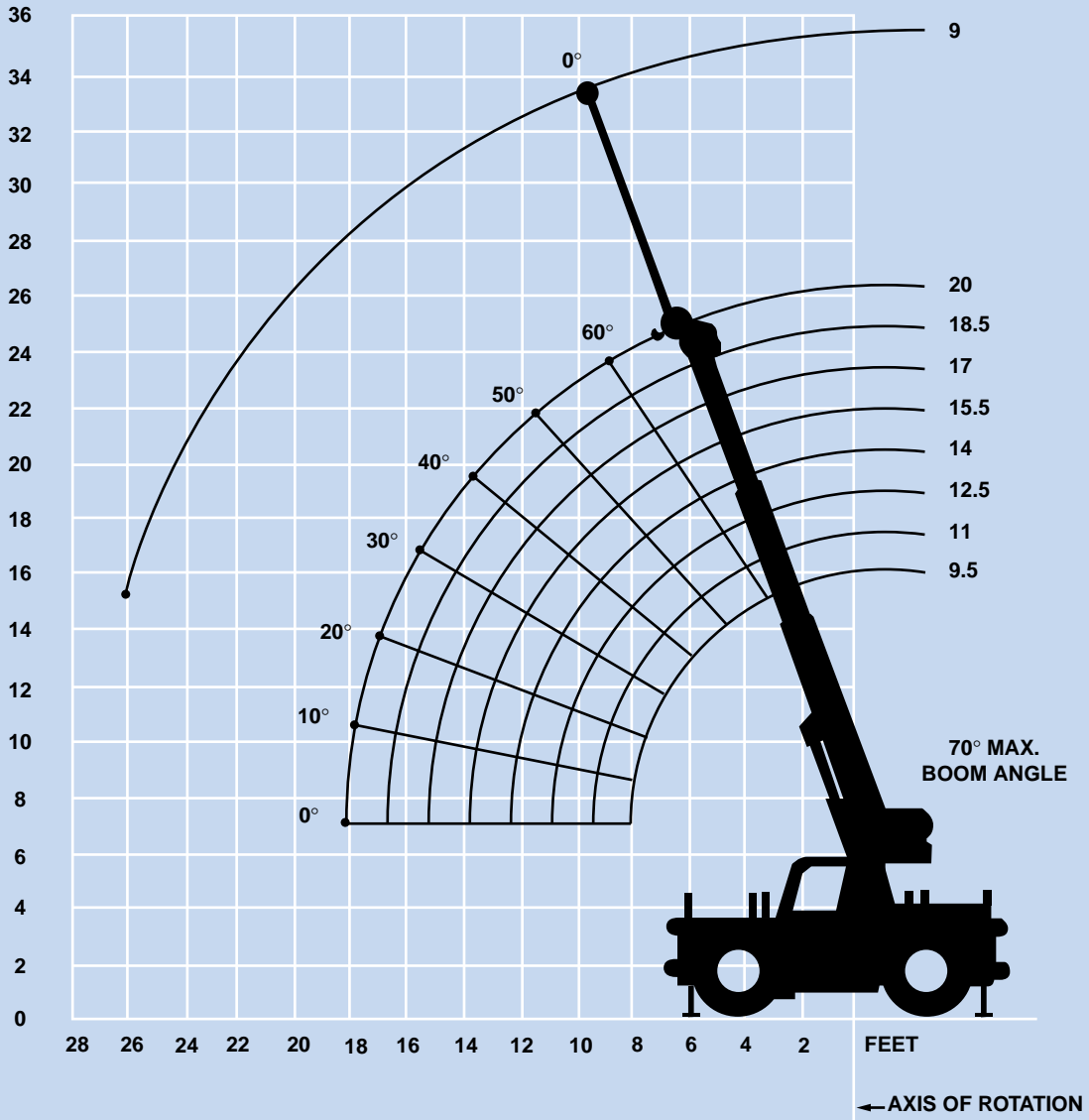

DIMENSIONS ARE FOR LARGEST GROVE FURNISHED HOOK BLOCK AND HEADACHE BALL, WITH ANTI-TWO BLOCK ACTIVATED.

Superstructure specifications

Boom

9.5 ft. - 20 ft. (2.9 m - 6.1 m) three-section full power boom.

Maximum tip height: 25 ft. 5 in. (7.7 m).

Fixed Swingaway Extension

9 ft. (2.74 m) swingaway extension. Stows alongside base boom section.

Maximum tip height: 33 ft. 9 in. (10.3 m).

Boom Nose

Two lower steel sheaves and one idler sheave mounted on bronze bushings with removable pin-type rope guards.

Searcher Hook

Boom nose mounted. 3,000 lbs. (1316 kg) capacity.

Boom Elevation

One double acting hydraulic cylinder with integral holding valve provides elevation from 0° to 70°.

Load Moment & Anti-Two Block System

Standard load moment and anti-two block system with audio-visual warning and control lever lockout. These systems provide electronic display of boom angle, length, radius, tip height, relative load moment, maximum permissible load and load indication and warning of impending two-block condition.

Cab

Standard frame mounted control station includes all crane function and driving controls, engine monitoring instrumentation and deluxe fabric seat with seat belt. Standard full vision, all steel fabricated enclosed cab with tinted safety glass throughout. Dash panel incorporates gauges for engine functions. Other features include skylight, sliding left & right side windows, electric windshield washer-wiper, circulating air fan and fire extinguisher.

Swing

Ball bearing swing circle with 360° continuous rotation. Grove planetary glide-swing with automatic type multi-disc brake.

Maximum speed: 2 RPM.

Counterweight

1,100 lbs. (498 kg) integral with superstructure and swings 360° within the chassis width.

Hydraulic System

One two section main gear pump with a combined capacity of 41 GPM (155 LPM), driven by carrier engine through PTO.

Two individual valve banks.

Return line type filter with full flow with by-pass protection and service indicator. Three micron rated replaceable cartridge.

30 gallon (114 L) reservoir.

*Optional remote-mounted oil cooler with thermostatically controlled electric motor driven fan.

System pressure check panel permits easy verification of circuit pressures.

HOIST SPECIFICATIONS

Main Hoist

Planetary reduction with automatic spring applied multi-disc brake and drum cable follower.

Maximum Single Line Pull: 5,275 lbs. (2390 kg)

Maximum Single Line Speed: 118 FPM (36 m/min)

Maximum Permissible Single Line Pull: 4,480 lbs. (2030 kg)
5:1 strength factor

Rope Diameter: 7/16 in. (11 mm)
18 x 19 Rotation Resistant

Rope Length: 110 ft. (33.5 m)

Maximum Rope Stowage: 128 ft. (39 m)

Note: 110 fr. (33.5 m) length of wire rope supplied with basic standard unit.

**Denotes optional equipment*

Carrier specifications

Chassis

High strength alloy steel construction with integral outrigger housings and front/rear lifting, towing and tie down lugs.

Carry deck with surface area of 38.9 sq. ft. (3.61 m²).

Outrigger System

Front and rear oblique type telescoping beams at all four corners with integral holding valves. Outrigger pads are an integral part of the beam and have a surface area of 54 sq. in. (349 cm²).

Maximum outrigger pad load: 10,613 lbs. (4814 kg).

Outrigger Controls

Controls and crane level indicator located in cab.

Engine

Continental TMD27 diesel, four cylinders, 66.5 bhp (49.5 kW) (Gross) @ 3,000 RPM.

Maximum torque: 124 ft. lbs. (168 Nm) @ 2,000 RPM.

*Optional Engine

Continental TM 2.7 L, four cylinder, 2.7 L gasoline engine, 70 bhp (52.3 kW) (Gross) @ 2,800 RPM.

Maximum torque: 147 ft. lbs. (199.3 Nm) @ 1,600 RPM.

Fuel Tank Capacity

29 gallons (109.8 L)

Transmission

Automatic with 3 speeds forward and 1 reverse with torque converter.

Electrical System

One 12 V - maintenance free battery. 12 V starting.

Drive

4 x 2

Steering

Rear: Full hydraulic power, controlled by steering wheel.

Axles

Front: Drive-type with no spin differential and planetary reduction hubs rigid mounted to chassis.

Rear: Steer-type rigid mounted to frame.

Brakes

Hydraulic drum and shoe type acting on front drive wheels. Toggle switch actuated parking brake located on front axle tail shaft.

Tires

8.25 x 15-12 PR tube type, deep mine lug.

Lights

Full lighting package including turn indicators, head, tail, brake and hazard warning lights.

Maximum Speed

15 MPH (24 kph) with automatic transmission.

Gradeability (Theoretical)

55% (Based on 11,075 lbs. [5023 kg] GVW).

Miscellaneous Standard Equipment

Front hookblock tiedown, fenders, decking post pockets, towing lugs (front and rear), pressure check spuds, pinion guard, tool/sling box, dual rear view mirrors, protectoseal fuel cap.

*Optional Equipment

- * Amber Flashing light
- * Cab spotlight
- * Tachometer
- * Cold start aid (Ether injection - Special order)
- * Engine block heater
- * Maintenance platform
- * Hookblocks
- * Tow winch front mounted (recessed)
5,000 lbs. (2268 kg)
- * Pintle hook front/rear
- * Carry deck posts
- * LP gas conversion kit for gas engine
- * Engine distress A/V warning system
- * Spark arrestor muffler
- * Boom mounted personnel platform
- * Dual fuel conversion
- * Removeable large O/R pads
- * Hydraulic oil cooler
- * Boom mounted flood light
- * 360° positive swing lock

**Denotes optional equipment*



9.5 - 20 ft.
(2.9 - 6.1 m)



100%



Pounds

(Feet)	Over Front	360 Degrees
4	*12,000	*12,000
4	10,400	10,400
5	10,400	10,400
6	10,400	10,400
8	9,150	8,150
10	6,390	6,390
12	5,350	4,900
14	4,580	3,700
16	3,890	2,950
18	<u>3,400</u>	2,350

*Fully retracted boom

A6-829-010210



9.5 - 20 ft.
(2.9 - 6.1 m)



8.25 x 15 - 12 PR



Pounds

(Feet)	Stationary Capacity Defined Arc Over Front	Stationary Capacity 360° Arc	Pick & Carry Capacity Up to 2.5 mph Boom Centered Over Front
4	10,400	8,200	9,000
5	9,350	6,950	8,000
6	8,150	<u>5,900</u>	7,000
8	<u>6,500</u>	3,450	5,000
10	4,350	2,300	3,500
12	3,200	1,620	2,200
14	2,450	1,170	1,500
16	2,000	860	1,200
18	1,650	630	<u>1,000</u>

A6-829-010212



9.5 - 20 ft.
(2.9 - 6.1 m)



9 ft.
(2.74 m)



100%



(Feet)

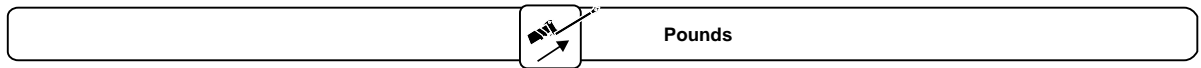

(Feet)	Over Front	360°
7	4,100	4,100
8	4,100	4,100
10	3,650	3,650
12	3,200	3,200
14	2,900	2,900
16	2,500	2,500
18	2,300	2,300
20	2,250	2,200
22	2,050	1,950
24	1,950	1,750
26	1,800	1,550

A6-829-010213A



9.5 - 20 ft.
(2.9 - 6.1 m)



9 ft.
(2.74 m)



8.25 x 15 - 12PR

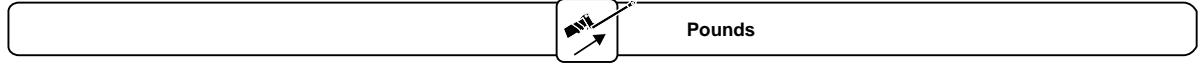

(Feet)	Over Front	360°
7	4,100	4,100
8	4,100	4,000
10	3,650	2,750
12	3,200	2,000
14	2,700	1,550
16	2,150	1,240
18	1,750	1,000
20	1,450	800
22	1,250	650
24	1,050	530
26	900	430

*On rubber over front includes defined arc of 6° on either side of longitudinal centerline of machine.

A6-829-010215B





































Rated Lifting Capacities

IMPORTANT NOTES:

WARNING: THIS CHART IS ONLY A GUIDE.
The notes below are for illustration only and should not be relied upon to operate the crane. The individual crane's load chart, operating instructions and other instruction plates must be read and understood prior to operating the crane.

1. All rated loads have been tested to and meet minimum requirements of SAE J1063 Nov93 - Cantilevered Boom Crane Structures - Method of Test, and do not exceed 85% of the tipping load on outriggers fully extended 75% tipping on rubber, as determined by SAE J765 OCT90 Crane Stability Test Code.
2. Rated loads include the weight of hookblock, slings and auxiliary lifting devices and their weights shall be subtracted from the listed rating to obtain the net load to be lifted. When more than the minimum required hoist reeving is used, the additional rope weight shall be considered part of the load to be handled.
3. Defined Arc $\pm 6^\circ$ on either side of longitudinal centerline of machine.
4. Capacities appearing above the bold line are based on structural strength. Tipping should never be relied upon as a capacity indicator.
5. All capacities are for crane on firm, level surface. It may be necessary to have structural supports under the outrigger floats or tires to spread the load to a larger bearing surface.
6. When either boom length or radius or both are between values listed, the smallest load shown at either the next larger radius or boom length shall be used.
7. Tires shall be inflated to the recommended pressure before lifting on rubber.
8. For outrigger operation, ALL outriggers shall be properly extended with tires raised free of ground before raising the boom or lifting loads.

Symbols Glossary

	Frame		Steering
	Outriggers		Transmission
	Outrigger Controls		Axles
	Engine		Brakes
	Fuel Tank Capacity		Tires
	Electrical System		Suspension
	Drive		Rotation
	Lights		Boom Elevation
	Cab		Swing
	Boom		Counterweight
	Fixed Swingaway		Oil
	Tele-Swingaway		Hydraulic System
	Jib		Hoist
	Boom Nose		Radius
	Boom Extension		Boom Length
	Speed		Hookblock
	Grade		Gear
	Lattice Extension		Luffing Jib

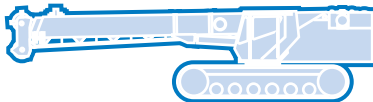
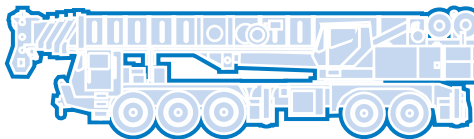
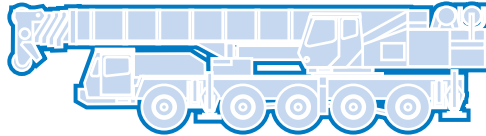
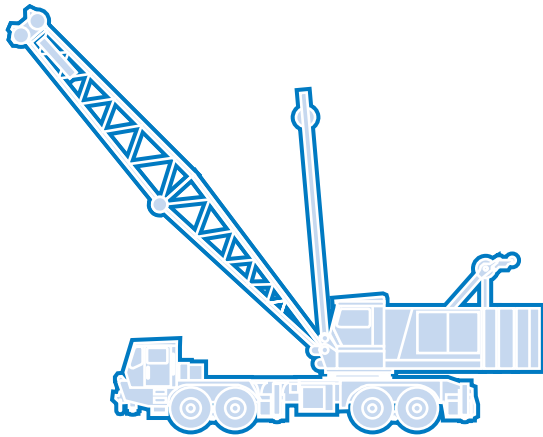

Grove Worldwide – World Headquarters

Grove North America
1565 Buchanan Trail East
P.O. Box 21
Shady Grove, Pennsylvania 17256, U.S.A.
Tel: [Int + 1] (717) 597-8121
Fax: [Int + 1] (717) 597-4062
Western Hemisphere, Asia/Pacific

Grove Europe Limited*
Sunderland SR4 6TT, England
Tel: [Int + 44] 191 565-6281
Fax: [Int + 44] 191 564-0442
Europe, Africa, Middle East

Grove Europe Limited*
P.O. Box No. 268
4A Kimber Road
Abingdon, Oxfordshire, OX141SG
Tel: [Int + 44] 1235 55-3184
Fax: [Int + 44] 1235 55-3218
*Grove Europe Limited, Registered in England,
Number 1845128. Registered office, Crown Works,
Pallion, Sunderland, Tyne & Wear, England SR4 6TT

Deutsche Grove GmbH
Sales and Service
Helmholtzstrasse 12, Postfach 5026
D-40750 Langenfeld, Germany
Tel: [Int + 49] (2173) 8909-0
Fax: [Int + 49] (2173) 8909-30

Wilhelmshaven Works
Industriegelände West, Postfach 1853
D-26358 Wilhelmshaven, Germany
Tel: [Int + 49] (4421) 294-0
Fax: [Int + 49] (4421) 294-301

Grove France S.A.
16, chaussée Jules-César, 95520 OSNY
B.P. 203, 95523 CERGY PONTOISE CEDEX
France
Tel: [Int + 33] (1) 30313150
Int: [Int + 33] (1) 30386085

Grove Asia/Pacific - Regional Office
171 Chin Swee Road
#06-01 San Centre
Singapore 0316
Tel: [Int + 65] 536-6112
Fax: [Int + 65] 536-6119
Asia/Pacific, Near East

Grove China - Representative Office
Beijing Hotel Room 6074
No. 33 East Chang An Avenue
Beijing, 100004, China
Tel: [Int + 86] (10) 513-7766
Fax: [Int + 86] (10) 513-7307

Grove Product Support
Western Hemisphere, Asia/Pacific
1086 Wayne Avenue
Chambersburg, Pennsylvania USA
Tel: [Int + 1] (717) 263-5100
Fax: [Int + 1] (717) 267-0404

Europe, Africa, Middle East
Sunderland SR4 6TT, England
Tel: [Int + 44] 191 565-6281
Parts Fax: [Int + 44] 191 510-9242
Service Fax: [Int + 44] 191 510-9560

<http://www.groveworldwide.com>

Constant improvement and engineering progress make it necessary that we reserve the right to make specification, equipment, and price changes without notice. Illustrations shown may include optional equipment and accessories and may not include all standard equipment.

Distributed By: