

Potain Igo MA 13

Data Sheet

FEM 1.001-A3

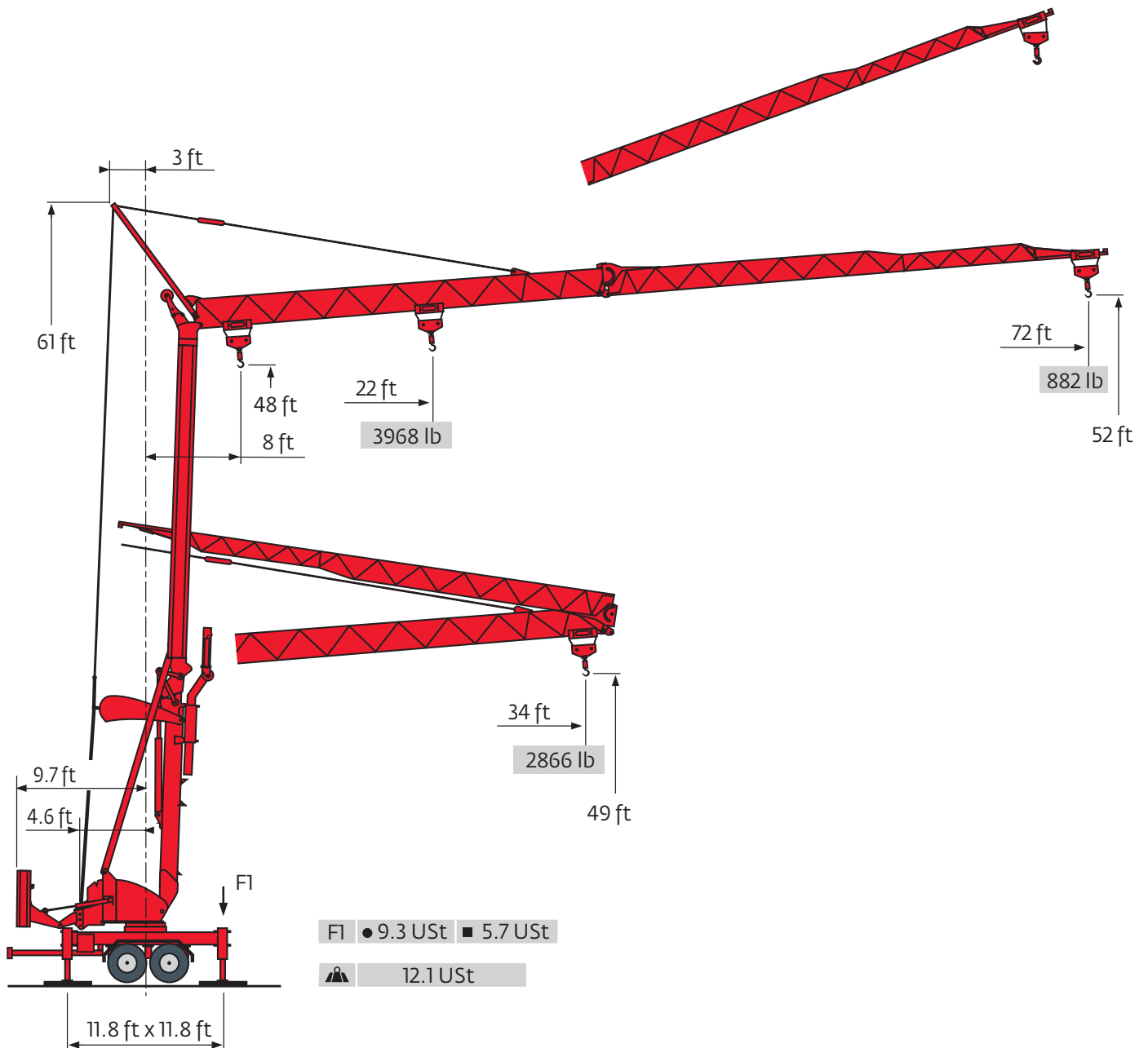

Values have been rounded

Load charts







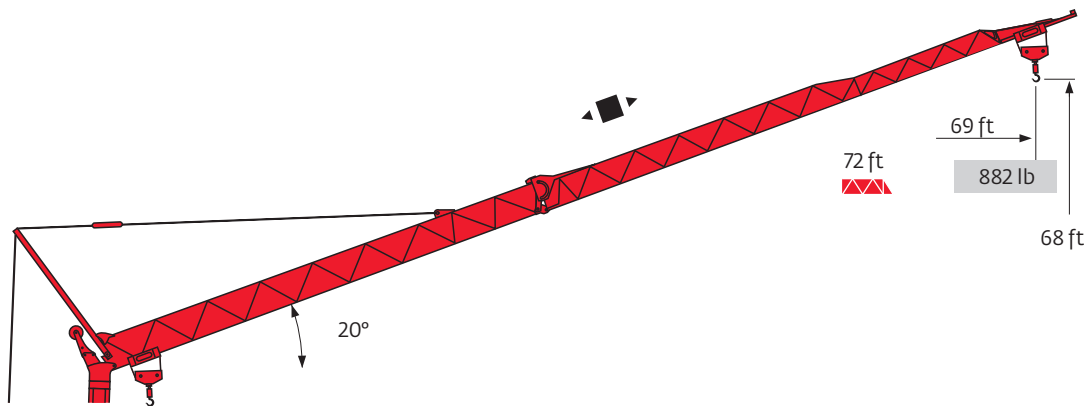







72 ft

8	▶	27	30	33	34	ft	22	23	26	30	33	36	39	43	46	49	52	56	59	62	66	69	72	ft
		3968	3461	3042	2866	lb	3968	3770	3175	2745	2403	2138	1918	1731	1576	1455	1334	1235	1146	1069	1003	937	882	lb



	Traversing trolley
	Reactions in service
	Reactions out of service
	Without load, ballast (or transport axles), with maximum jib and maximum height



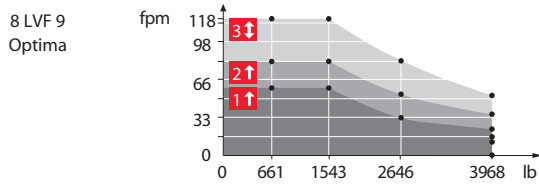

Mechanisms

									hp	kW	
	8 LVF 9 Optima	220 V  21 A  1	fpm	↑ 12	↓ 12	↑ 23	↓ 53	↑ 60	↓ 119	3.3	2.4
		lb	3968		3968		1543				
		220 V  34 A  2	fpm	↑ 12	↓ 12	↑ 37	↓ 52	↑ 83	↓ 119	5.2	3.8
		lb	3968		3968		1543				
		480 V  3	fpm	↓ 12		↓ 53		↓ 119		7.5	5.5
		lb	3968		3968		1543				
	1 DVF 4	-	fpm	46 - 92						1.5	1.1
	RVF 20	-	rpm	0 → 1						1.5	1.1
							kW				
			220 V(+6% -10%) 60 Hz 				220 V 21 A: 2.4 kW 220 V 34 A: 3.8 kW				
			480 V(+6% -10%) 60 Hz				480 V: 14 kW				

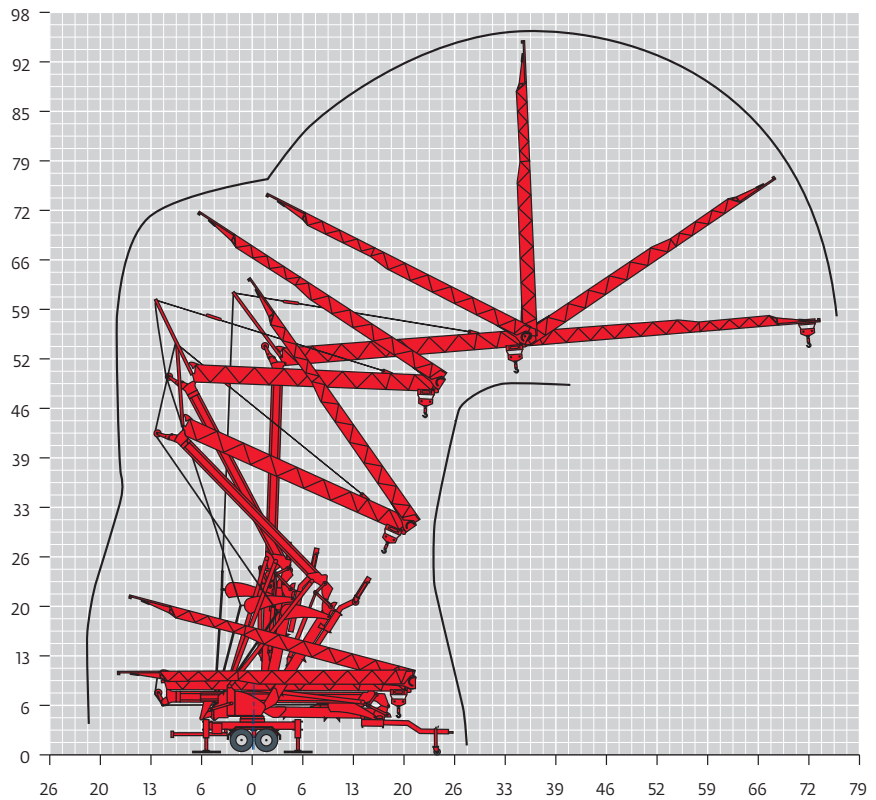

Crane profile



-  Hoisting
-  Trolleying
-  Slewing
-  60 Hz Single phase

Transport

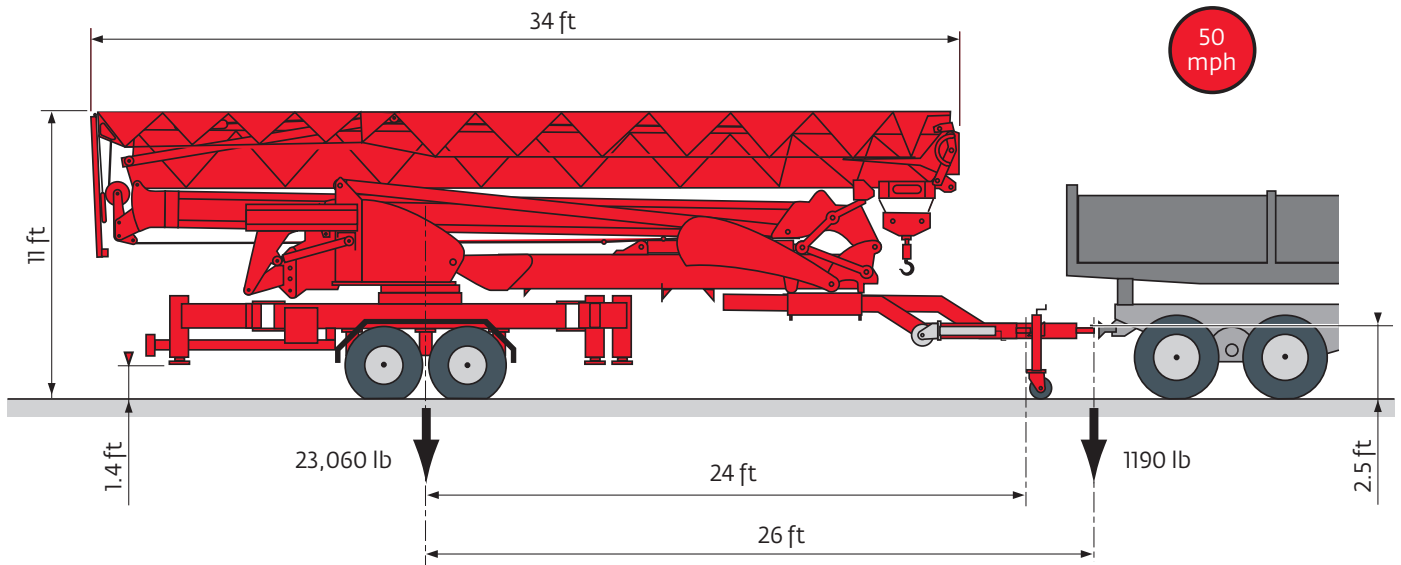

Constant improvement and engineering progress make it necessary that we reserve the right to make specification, equipment and price changes without notice. Illustrations shown may include optional equipment and accessories, and may not include all standard equipment.



www.manitowoc.com

Regional Headquarters

Americas

Manitowoc, Wisconsin, USA
Tel: +1 920 684 6621
Fax: +1 920 683 6277

Shady Grove, Pennsylvania, USA
Tel: +1 717 597 8121
Fax: +1 717 597 4062

Europe, Middle East, Africa

Ecully, France
Tel: +33 472 18 2020
Fax: +33 472 18 2000

Asia - Pacific

Shanghai, China
Tel: +86 21 6457 0066
Fax: +86 21 6457 4955

Potain Igo MA13
Code 04-020-2M-1209