

National Series 400 Proposal

Date: _____	
Prepared for: _____	
Submitted by: _____	
(Firm Name)	
(Address)	
(City & State)	
(Zip)	
(Phone)	
Signed: _____	

National reserves the right to change designs, prices, and specifications at any time without notice.

Your National Dealer

Description	Price
1. Series _____	\$ _____
2. Duct if torsion box not required	(_____)
3. Boom _____	_____
4. Jib _____	_____
5. Rear Stabilizers <input type="checkbox"/> ASH <input type="checkbox"/> RSH 18"	_____
6. Front Stabilizers <input type="checkbox"/> Std <input type="checkbox"/> Tilt <input type="checkbox"/> Single	_____
7. Line Block <input type="checkbox"/> 2 Part <input type="checkbox"/> 2 & 3 Part	_____
Accessories	
8. PD-12 Planetary Winch	_____
9. _____	_____
10. _____	_____
11. _____	_____
Mounting	
12. Installation: Behind Cab	_____
13. Installation: Rear Mounting (add to installation charge above)	_____
<input type="checkbox"/> ASH Behind Cab Stabilizers	_____
<input type="checkbox"/> Air Throttle	_____
<input type="checkbox"/> Rear Mounting Group	_____
<input type="checkbox"/> HO Outriggers	_____
14. Frame Reinforcement: <input type="checkbox"/> Weld <input type="checkbox"/> Bolt-Extra	_____
15. Platform Body _____ ft. <input type="checkbox"/> Wood <input type="checkbox"/> Steel	_____
16. Weight in bed _____ lbs. (if required)	_____
17. Boom rest: <input type="checkbox"/> Parallel <input type="checkbox"/> Low <input type="checkbox"/> Other	_____
18. Mount Stabilizers (Rear) _____	_____
19. Mount Stabilizers (Front) _____	_____
20. Chassis _____	_____
21. Rear Bumper Underride Protection <input type="checkbox"/> Ordered <input type="checkbox"/> Not Ordered	_____
22. Freight _____	_____
This quotation will remain firm for _____ days.	
Accepted by: _____	\$ _____
(Name)	TOTAL PRICE
(Firm Name)	(Date)



NATIONAL CRANE
 Subsidiary of Kidde, Inc.
General Offices: 11200 North 148th Street/Waverly, NE 68462
 402/786-2240
 Tele: 438061

NATIONAL SERIES 400

Truck-Mounted Telescoping Cranes and Accessories

Maximum Vertical Reach: 93 Feet (28.3 Meters)
 Maximum Capacity: 16,000 Pounds (7.3 Metric Tons)

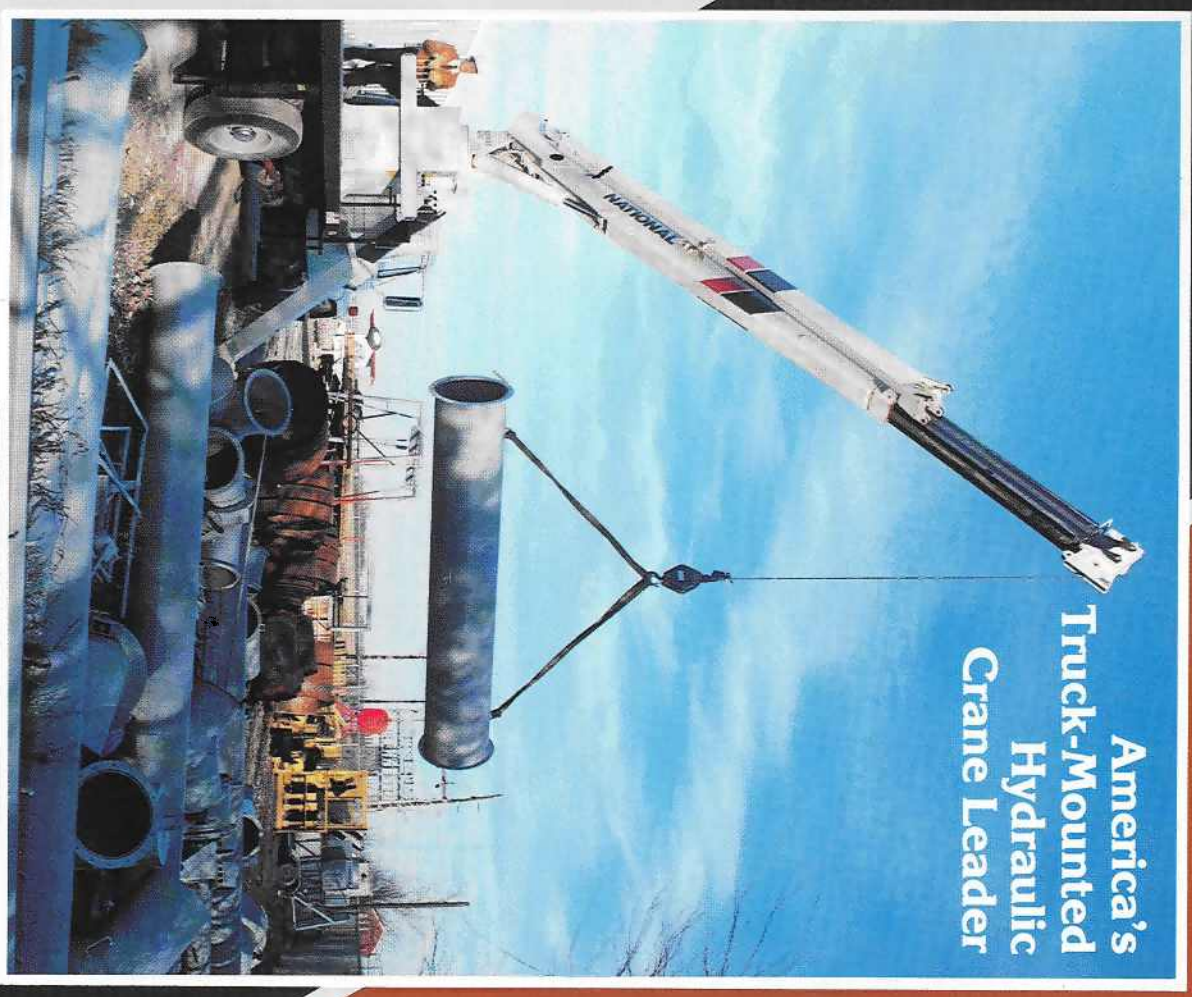

**America's
Truck-Mounted
Hydraulic
Crane Leader**

NATIONAL SERIES 400

A Tough and Dependable Medium Duty Telescoping Crane from National

National is America's leading manufacturer of commercial truck-mounted telescoping and articulating cranes. We build cranes for a wide range of jobs. And nobody builds them better. Nationals are tough, durable, and dependable. They are designed for ease of operation.

With a National, you are assured of a well-engineered, well-manufactured, and fully tested machine designed for your applications. At National, we put quality first. Our commitment to product quality is our pledge to provide our customers with reliable products designed to provide years of service.

Our Series 400 telescoping crane gives you everything you want and need in a tough, compact, 8-ton-capacity crane. Consider these features:

- 8-ton (7.3MT) rated capacity
- Reaches up to 93 feet (28.3m) high
- Increased capacity
- Stronger booms that lift more
- New, improved locks on boom sequential extension
- Lighter unit weight allows more payload capacity
- Wide 15-foot (4.57m) outrigger span for greater stability
- Extra large wear pads in boom last longer and are easier to replace
- Dual controls in SAE recommended orientation, each with foot throttle
- Standard high-performance planetary winch with rotation resistant cable
- Standard anti two block feature to prevent cable damage when winching up or extending the boom without paying out the winch cable

- Planetary rotation gear box with a hydraulic release brake and a slip-through feature that helps protect the rotation system against damage from accidental side loading
- Outrigger location (behind operator) allows occasional 360° working area without front stabilizers when mounted on recommended truck
- Larger outrigger pads provide greater stability in soft footing
- Mounts on standard, single rear axle trucks with the versatility of three mounting configurations
- New boom pivot and hoist cylinder bearings provide longer life and lower maintenance
- New standard tandem pump system isolates winch from other crane functions to provide better overall performance
- Horn and stop switches located at control stations
- Complete accessory line adds to versatility

National's anti two block system is standard on all National telescoping cranes (as of June 1, 1986). Photos in this brochure taken prior to that date may not show the crane equipped with the current standard anti two block protection system.



NATIONAL CRANE CORPORATION
 To provide our customers with products where Quality and Reliability are integral with design and manufacturing.
COMMITMENT TO QUALITY



The National Testing Program

National Crane established its original product durability standards by carefully evaluating the performance of competitive machines. Taking the best performances from these tests, National engineers set their own standards **more than 50% higher!** This is the same testing program each National must pass today.

Before a new model is released for production manufacturing it is subjected

to state-of-the-art testing. For example, a plastic-based "brittle lacquer" coating is applied to the boom. After loading the boom, test engineers inspect the coating for cracks. The special lacquer has virtually no elastic qualities, so stretching or deformation of the metal shows up in "fractures" of the coating, perpendicular to the direction of stretching.

This procedure indicates where engineers are to place strain gauges, tiny chips printed with electronic circuitry which expand or

contract with changes in the metal. Minute changes in electrical resistance are measured by a computerized strain gauge monitor and printed out for engineering studies. These strain gauges measure current fluctuations as small as one-millionth of an ohm—which measures metal deformation as small as one-millionth of an inch.

After strain gauge testing, the prototype of each new model undergoes life-cycle testing. The crane is operated at full-load through a full life-cycle under close scrutiny.

Outriggers, frames, and other components are loaded and rotated through a complete range of motion for the prescribed number of cycles. More than 400 individual quality control inspections are made on each National crane during manufacture and assembly. National attention to testing ensures that each crane delivered to the field is as close to perfect as state-of-the-art technology permits.

National Series 400

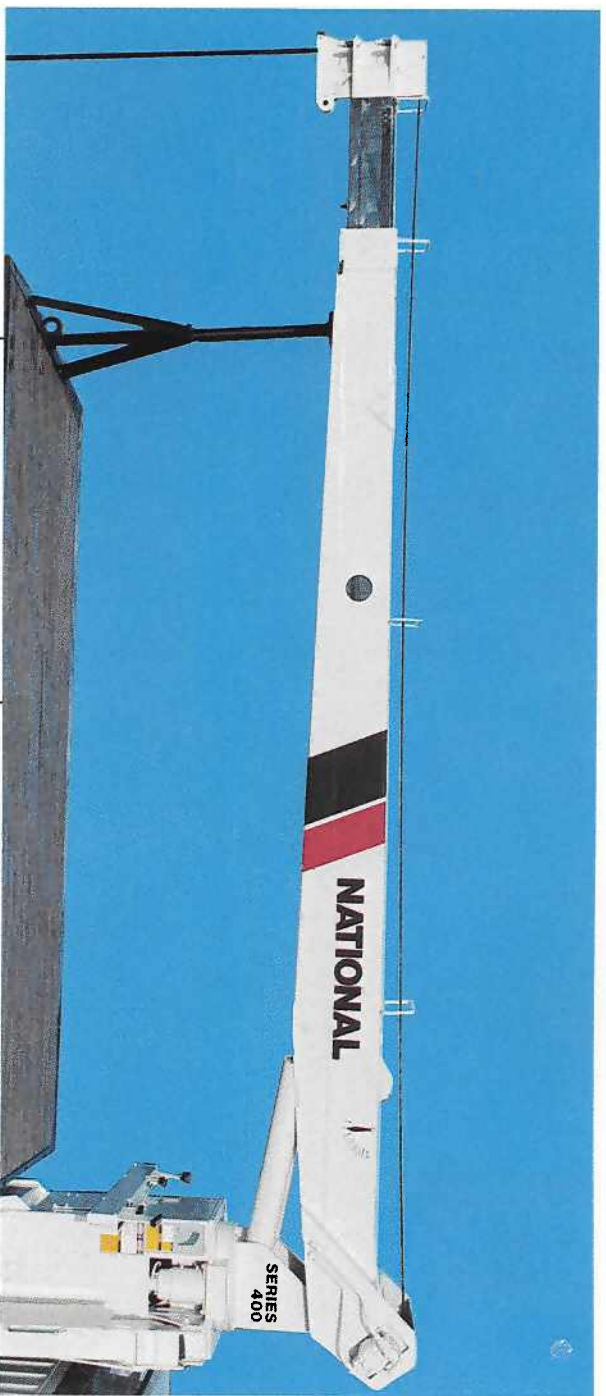

Stronger, Lighter Booms

Through computer aided design, National has removed weight from the Series 400 boom sections, yet has increased the crane's capacity. Extra strength and lighter boom weight mean greater capacity for you. That's why we fabricate our telescoping boom sections from four high-strength steel members welded with perpendicular corners. This box-section construction lets us use thicker top and bottom plates for extra strength. The use of thinner side plates means increased capacity through lower boom weight. Only strong, low alloy steel is used in National booms. It is welded with advanced, automatic, low-hydrogen techniques for extra strong seams. Corner seams are ultrasonically tested for proper penetration. The National Series 400 is equipped on all sides with extra large nylon wear pads impregnated with lubricants which provide a smooth, long-life operation. The wear resistance of the material used in the Series 400 pads is unexcelled by competitive models.

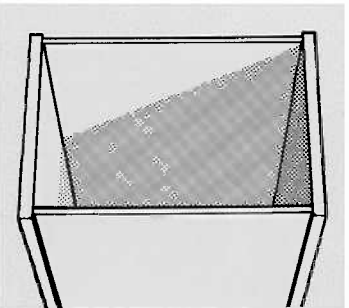

Sequential Extension

National introduced sequential, full-load extension to the industry. Our boom sections interlock for sequential extension. The larger, stronger boom sections extend first for greater strength. National's patented locks are mechanical, not hydraulic. They provide reliability with no excessive noise or wasted hydraulic power. They are just one more example of how National know-how and attention to quality pays off in performance for you.

High Performance Planetary Winch

A high-performance planetary winch is standard on the 400. This high-efficiency winch coupled with a high-efficiency motor and a counterbalance valve provides extremely smooth loadline control and quiet operation. It allows extended duty without excessive power loss.



Do not operate crane or accessories within 10 feet (3m) of live power lines.

Positive Planetary Turret Rotation

The planetary rotation gearbox with a hydraulic release brake allows the gearbox to backdrive whenever excessive side load is applied to the boom, reducing shock loads on the upper and lower crane structure and gearbox. The turret drive is designed with extra heavy bearings below the drive pinion. The gearbox and rotation bearing mounting surface are precision machined after welding. This ensures constant tooth alignment for smooth rotation and low wear, even under maximum loads. The entire turret glides smoothly on a low inertia ball bearing race. Rotation is 375° noncontinuous.

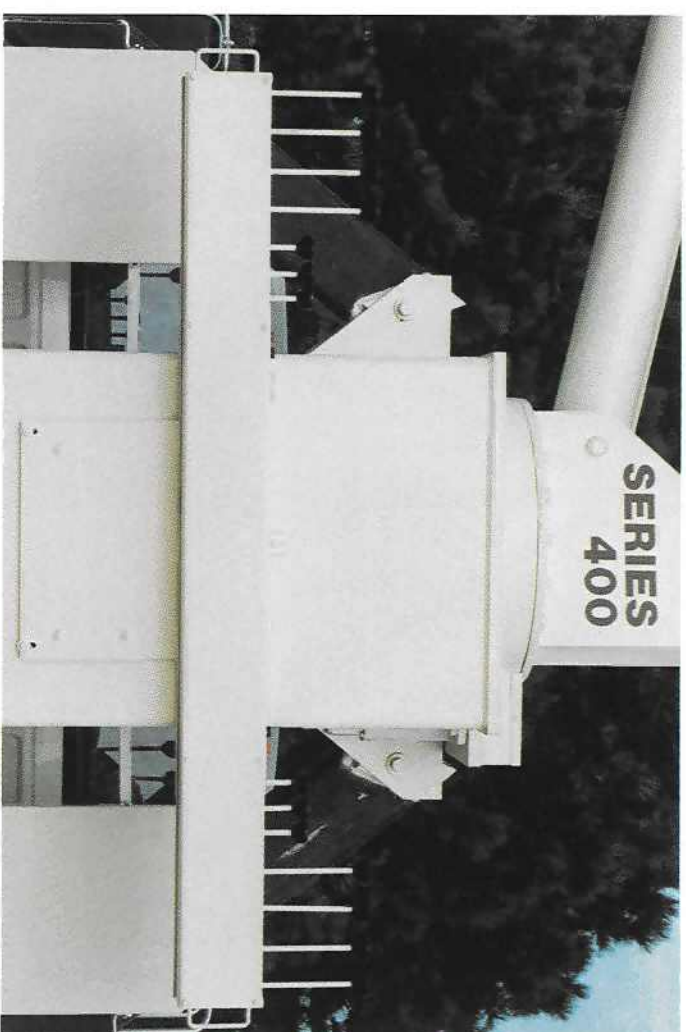
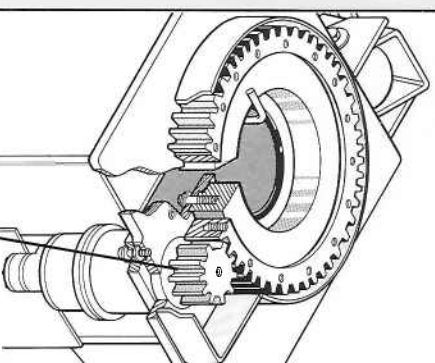

Dual Controls

Dual controls are standard on the Series 400. The extra fine metering and low spool forces give you smoother, more precise control. Crane controls are identical on each side with SAE recommended orientation of functions. That means you always work the same control with the same hand. Dual stations provide more efficient operations and greater load visibility. Each station is equipped with kill and audible warning switches. A system pressure gauge is standard. Foot throttles allow identical foot operation of engine speed from either side.



Easy Service, Low Downtime

We designed the Series 400 with boom access holes for serviceability. The Series 400 frame allows easy access to control valves and plumbing for minor adjustments and fitting tightening. The complete console is easily removable for major repair





Wide Stance
We've given our Series 400 the industry-acclaimed National out-and-down outriggers for a consistently wide stance and better leveling on uneven ground. The outriggers retract smoothly, without binding under load, first moving up, then in. Their efficient design

and wider span — 15-foot (4,570mm) — gives you greater stability with less truck weight, so you can carry larger payloads. The 400 is equipped with larger pads for greater stability in soft footing. A precision mounted level indicator aids the operator in leveling the unit during the set-up procedure.

**National's
"Out-and-Down"
Stable Outriggers**
CRANE

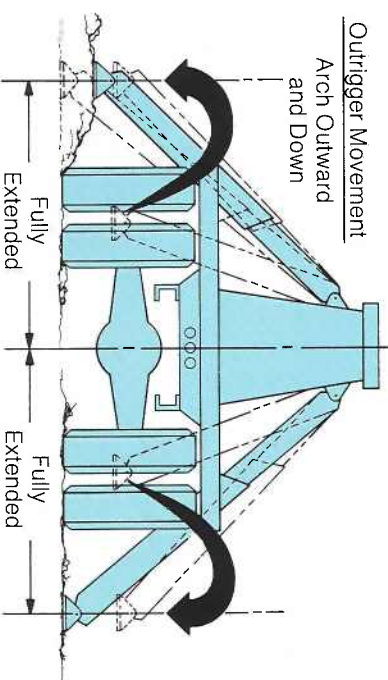

- Outriggers **equally** spaced from crane center line.
- Consistent outrigger span.
- Crane will be equally stable on both sides.



Less Weight
The Series 400 is designed with wider outriggers and a new rigid subframe to reduce the need for counterweight on virtually every truck on which it can be mounted. Even with its increased capacity, it weighs less than its predecessor model when mounted on the same minimum truck.

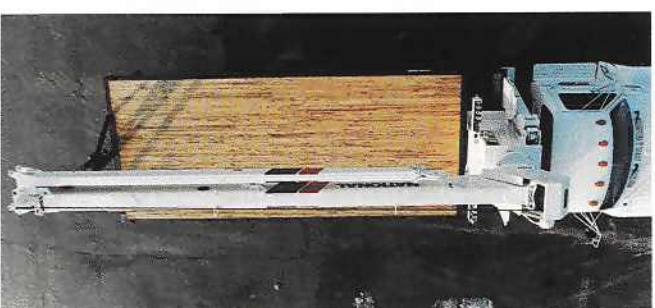

Less Space
The National Series 400 is built tough, but compact, so it fits in just 36 inches (923mm) of bed space. That leaves ample payload space, making your Series 400 even more versatile. The 400 controls and operator platforms are designed with an improved access to the truck bed, permitting the operator to move from one control station to the other. The operator platforms are made with open mesh expanded metal to keep dirt and mud buildup to a minimum.



Anti Two Block
The 400 is equipped with a standard anti two block attachment. Two blocking occurs when the winch cable and attachments contact the underside of the boom sheave case, whether by winching up or extending the boom without paying out the winch cable. When this

happens, the cable can be damaged by crimping or over-tensioning. The anti two block attachment prevents cable damage by sensing the position of the winch cable end attachments with respect to the sheave case and shutting down the functions that can cause two blocking.



The National Warranty
No product is better than its warranty. And no warranty is better than the company behind it.

We didn't get to be America's largest manufacturer of truck-mounted telescoping and articulating cranes by building less than the best. Or backing them with less than a comprehensive warranty.

Our warranty covers your crane against defects in materials or workmanship for **six full months** from the date of shipment, subject to the conditions of the warranty.

When you select a National crane, you're getting more than just a crane. You're getting a nationwide dealer warranty service network, strong warranty protection and our special concern for every product we make. Read our warranty. Then, don't settle for less. For complete information, write National Warranty Service, Waverly, NE 68462.



The National Parts System
Authorized National Crane dealers maintain a parts supply to support the National cranes in each dealer's area. If a dealer cannot immediately supply a needed part, the factory can normally provide the part to the dealer within 48 hours on request. National's responsiveness to dealer requests means that your crane will be back on the job fast. National maintains a highly trained Service and Parts staff to answer dealer service questions and expedite parts shipping.

The National Service Center
National maintains a well-equipped service center where we do all our factory crane mounting. The central location of our Service Center makes it easy to return cranes for special modifications or extreme repairs. Most National dealers can perform all but the most unusual modifications or most serious repairs. Should you need to return your crane to us for modification, warranty repair or other service, we will give it priority care and see it's returned as soon as possible.

National Series 400 Booms and Jibs

Heights to 93 feet (28.3m) available

The National Series 400 is available with a choice of booms and jibs. One of these combinations is right for your 8-ton capacity lifting requirements. Select the telescoping boom you want, then add one of National's jib options as a cost-efficient

way to increase the capacity and versatility of your Series 400.

The charts below show the capacities of our most popular Series 400s: the 446 and 455. Your National dealer can provide detailed information on the boom/jib combinations that are available on the Series 400.

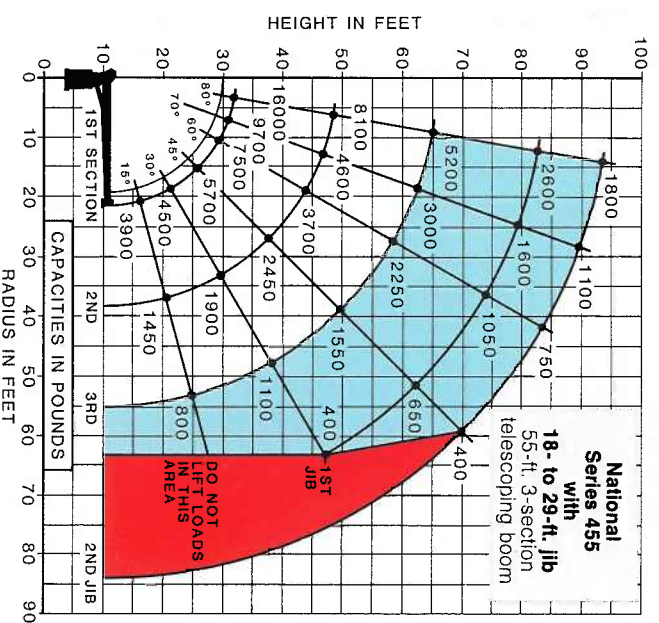
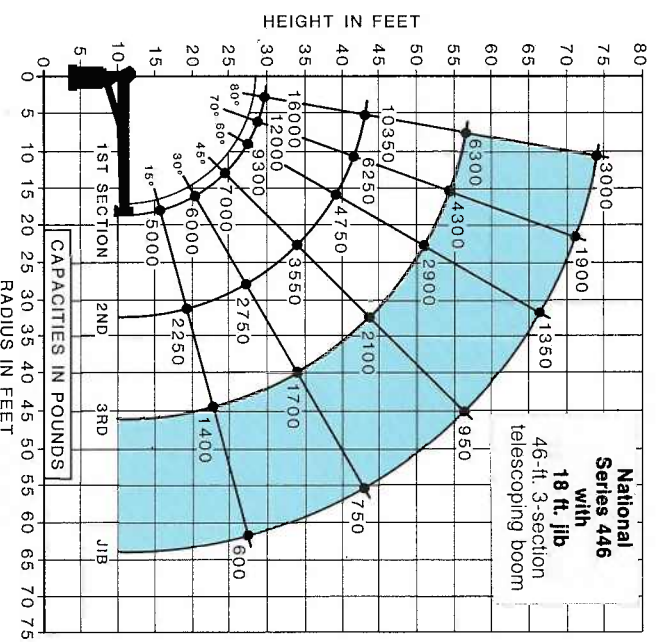

Boom and Jib Combinations

Telescoping Booms

- Model 426: 15½- to 26-foot (4.7m to 7.9m) two section
- Model 428: 12½- to 28-foot (3.8m to 8.6m) three section
- Model 437: 15½- to 37-foot (4.7m to 11.3m) three section
- Model 446: 18½- to 46-foot (5.6m to 14m) three section
- Model 455: 21½- to 55-foot (6.6m to 16.8m) three section

Jib Options (side stowing)

- Model 4FJ12: 12-foot (3.7m) straight (for Model 428)
- Model 4FJ15: 15-foot (4.6m) straight (for Models 426, 437)
- Model 4FJ18: 18-foot (5.5m) straight (for Models 446, 455)
- Model 4FJ29: 18- to 29-foot (5.5m to 8.8m) manual pull-out (for Models 446, 455)

455 Capacity*

(Metric equivalents shown in parentheses)

Radius	All booms Retracted	Second Section Extended	Third Section Extended
Maximum Capacity	16,000 lbs. (7,258kg)		
8' (2.4m)	9,800 lbs. (4,445kg)	8,300 lbs. (3,765kg)	
12' (3.7m)	7,200 lbs. (3,226kg)	5,900 lbs. (2,676kg)	5,300 lbs. (2,404kg)
16' (4.9m)	5,700 lbs. (2,586kg)	4,600 lbs. (2,087kg)	4,100 lbs. (1,860kg)
20' (6.1m)	4,500 lbs. (2,041kg)	3,700 lbs. (1,678kg)	3,100 lbs. (1,406kg)
24' (7.3m)	3,100 lbs. (1,406kg)	2,700 lbs. (1,225kg)	
28' (8.5m)	2,600 lbs. (1,179kg)	2,350 lbs. (1,066kg)	
32' (9.8m)	2,250 lbs. (1,021kg)	2,100 lbs. (953kg)	
36' (11m)	1,800 lbs. (816kg)	1,850 lbs. (839kg)	
40' (12.2m)	1,600 lbs. (726kg)	1,600 lbs. (726kg)	
44' (13.4m)	1,400 lbs. (635kg)	1,400 lbs. (635kg)	
48' (14.6m)	1,200 lbs. (544kg)	1,200 lbs. (544kg)	
52' (15.8m)		1,000 lbs. (454kg)	

*Capacities shown are for the 455 with the load suspended, radius shown includes increase due to boom deflection. Capacities vary for cranes equipped with jibs or attachments. Consult factory for specific load rating information.

Do not operate cranes or accessories within 10 feet (3m) of live power lines.

1. Load ratings shown on these charts are maximum allowable loads with the outriggers properly extended on a firm, level surface and the crane leveled and mounted on a factory-recommended truck.
2. Always level the crane with the level indicator located on the crane frame.
3. The operator must reduce loads to allow for factors such as wind, ground conditions, operating speeds and the effect of freely suspended loads.
4. Overloading the crane may cause structural collapse or instability.
5. Weights of any accessories attached to the boom or loadline must be deducted from the load chart capacities.
6. Do not exceed jib capacities at any reduced boom lengths.



The sequence of photos above shows how a National jib folds out into working position.

NATIONAL SERIES 400 WINCH DATA

Winch	Cable Supplied	Average Breaking Strength	Lift and Speed	Lift and Speed	Lift and Speed
Standard Planetary Winch	Standard ½" diam. rotation resistant	27,500 lbs.	5,500 lbs. 184 fpm	11,000 lbs. 92 fpm	16,000 lbs. 61 fpm
Optional Planetary Winch	Optional ½" diam. 6 x 19 or 6 x 25 IWRC	23,000 lbs.	5,500 lbs. 184 fpm	11,000 lbs. 92 fpm	16,000 lbs. 61 fpm
Optional High-pull Planetary Winch	Standard 9/16" diam. rotation resistant	35,000 lbs.	7,000 lbs. 140 fpm	14,000 lbs. 70 fpm	16,000 lbs. 61 fpm
	Optional 9/16" diam. 6 x 19 or 6 x 25 IWRC	29,750 lbs.	8,400 lbs. 110 fpm	16,000 lbs. 55 fpm	—

Caution:
 • Do not deadhead lineblock against boom tip when extending boom.
 • Keep at least three wraps of load line on drum at all times.
 • Use only the specified cable on this machine.

All winch pulls and speeds are shown on the third layer. Winch pulls would increase on the first and second layers. Winch line speeds would decrease on the first and second layers. Winch pulls may be limited by the winch capacity or the OSHA 5 to 1 safety factor. These are shown below:

Winch	Winch Limited	Cable Limited
Standard Planetary	6,450 pounds	5,500 pounds
Optional Planetary	10,200 pounds	7,000 pounds

National Series 400 Truck Specifications

Mounting Configurations	Configuration 1 with Subbase	Configuration 2 with Heavy Duty Subbase	Configuration 3 without Subbase
<p>The versatility of the Series 400 can be enhanced by the mounting configurations described at the right. The configurations are based on the 455 with an 85% stability factor. The complete unit must be installed in accordance with factory requirements and a test performed to determine actual stability and counterweight requirements since individual truck chassis vary.</p>	<p>In most cases, if the truck is purchased to minimum specifications, this configuration with subbase allows 360° stability without counterweight. Since the front tires are used as a stabilizing base, lifting over the front is recommended only for occasional use. If loads are to be continually lifted around the front of the vehicle, front stabilizers are recommended to give this unit a firm base. With this configuration, a payload of approximately 7,000 pounds can be hauled on a minimum truck.</p>	<p>The advantages of a rear-mounted Series 400 are: (1) it allows the operator to effectively use the close-in working area to lift heavier loads, and (2) 360° solid stability at full rated load. Counterweight up to 3,000 pounds will be required on a minimum truck. With this configuration, a payload of approximately 4,000 pounds can be hauled on a minimum truck. Underframe stabilizers behind the cab may interfere with the drive line or cause ground clearance problems. If so, contact the factory for alternatives.</p>	<p>The Series 400 can be mounted without the factory-furnished subbase provided that the truck is above minimum specifications for truck frame strength and chassis weight. A 400 mounted in this manner will also be 360° stable, however, front stabilizers are recommended for continual lifting over the front of the vehicle as noted in Configuration 1.</p>
Stable	360°	360°	360°
Gross Axle Weight Rating (GAWR), Front	9,000 lbs.	9,000 lbs.	9,000 lbs.
Gross Axle Weight Rating (GAWR), Rear	17,500 lbs.	17,500 lbs.	17,500 lbs.
Wheelbase (WB)	184 inches on Model 437 202 inches on Models 446, 455	202 inches	Same as Configuration 1
Cab to axle/runion (CA/CT)	120 inches on Model 437 138 inches on Models 446, 455	138 inches	Same as Configuration 1
Frame Section Modulus (SM) under crane	13 inch ³	13 inch ³	22 inch ³
or	10 inch ³	10 inch ³	15 inch ³
Frame Section Modulus (SM) over rear stabilizers	10 inch ³	13 inch ³	13 inch ³
50,000 PSI	10 inch ³	10 inch ³	10 inch ³
or	10 inch ³	10 inch ³	10 inch ³
110,000 PSI	4,800 lbs.	5,900 lbs.	5,400 lbs.
Stability Weight, Front†	4,600 lbs.	6,800 lbs.	5,000 lbs.
Stability Weight, Rear†	19,500 lbs.	22,500 lbs.	20,000 lbs.
Estimated Average Final Weight (No Options Included)			

- NOTES:**
- (1) GAWR means gross axle weight rating and is dependent on all components of the vehicle such as axles, tires, springs, frame, etc. meeting manufacturer's recommendations. **Always specify GAWR when purchasing trucks.**
 - (2) Minimum axle requirements may increase with use of longer wheelbase, service bodies, diesel engines or front stabilizers.
 - (3) Tandem axle trucks must be used for hauling larger payloads.
 - (4) Diesel engines require variable speed governor and energize-to-run fuel solenoid for smooth crane operation.
 - (5) On trucks shorter than 120 CA, additional weight may be required at the rear axle for 360° stability.

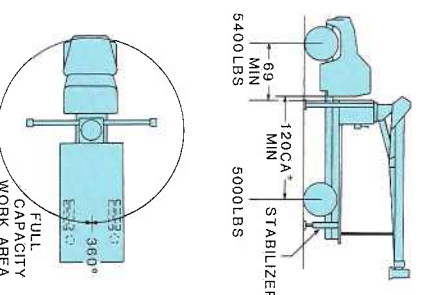
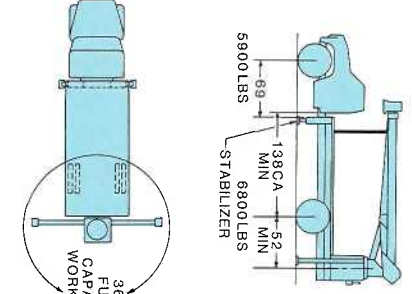
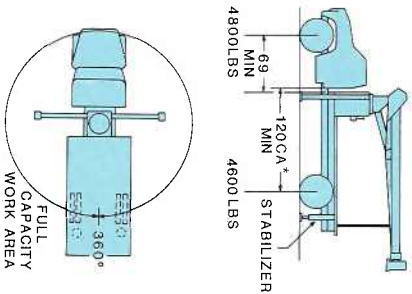

*May use shorter CA with model 437 or 446, depending upon bed length.
†Estimated axle scale weights prior to installation of crane, stabilizers, and subbase if required for 85% stability.

National Series 400 Boom Rests

Cranes are tough when they're in use, but they can be severely damaged during travel from job to job. The only way a crane can be protected from this type of wear and damage is a strong, solid, boom rest.

Boom Rests

- Add years to the life of your crane
- Reduce stress on the crane frame
- Protect rotation gear from transit damage
- Remove stress from truck frame
- Spread crane load more evenly
- Reduce maintenance and down time

In addition, boom rests are required to provide a positive way to immobilize your crane for transit. National Crane supplies five heavy-duty boom rests for strong, sure protection of your crane. There is a quality National boom rest to fit your mounting configuration. All National Cranes must be fitted with a boom rest. All factory mounted cranes will be supplied with a boom rest. NOTE: Only shorter booms can be stowed forward.

Front mount for trucks with tilting hoods

Low-profile rear bed mount for lower center of gravity

Tractor/trailer front mount

Tractor/trailer rear mount

Larger Front Axle Rating Required.

Horizontal rear bed mount for greater load space

National Series 400 Accessories

Every Series 400 is part of the National Lifting System.

The National Lifting System can equip your 400 to do more than just lift or handle materials. It lets you equip your truck-mounted crane to perform the functions of a whole fleet of specialized vehicles, and at a fraction of the cost.

Because your 400 can do so many jobs from start to finish, you save time, money, and manpower on almost every job you do. You'll find you can do more, faster, with less equipment. And that's money in your pocket.

National accessories are designed and manufactured to the same excellent standard as our cranes. This provides you with years of low-maintenance, high-productivity service.

Get the most from your National 400. Make it more than just a crane with cost-efficient, hard-working accessories from the National Lifting System.

Note:

Weights of all accessories attached to the boom or loadline of the crane must be deducted from the effective lifting capacity.

Consult your dealer for specific accessory availability. Some accessories cannot be used in combination with other accessories and/or certain boom/jib combinations.

Caution

Do not operate crane booms, jib extensions, any accessories, or loads within 10 feet (3m) of live power lines. Do not exceed jib capacities at any reduced boom lengths.

Remote Control

National offers one-hand remote control for your Series 400. Ideal for use where precise control and total load visibility are required.

Fine metering and instant response mean operators can position loads or work platforms easily.

National's remote controls are built with solid state circuitry and few working parts. They are designed for reliability. You will be impressed with the high operating speeds and modular design.

Available in two models: R4 with tilt, turn, telescope and winch functions, and R3 with tilt, turn, and telescope only. R3 should be used to control cranes from basket, using optional extension cables.

A priority control valve, operated by a trigger on the remote control unit, regulates oil flow and gives you fingertip speed control over all crane functions.

National's remote control is the lightweight, easy-to-use way to add extra versatility to your crane. Consult your dealer or the factory for availability.

Model R3

Tilt, turn and telescope

Model R4

Tilt, turn, telescope and winch.

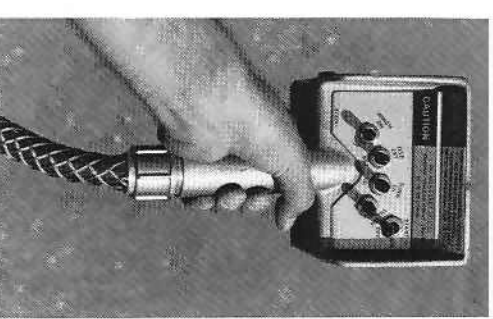

One Person Basket

Strong, lightweight fiberglass basket with 300 pounds capacity puts personnel where you want them for tough maintenance and installation jobs. Optional dual basket bracket for two-basket operation on main boom.

(Note: Jib will accommodate only one basket.) Easy on-off. Safety belts included. With basket(s) attached to the crane, the crane must not be operated at a position where the crane load chart shows less than the following capacities:

- One fiberglass basket—550 pounds
- Two fiberglass baskets—1,100 pounds

Model B1 Model B1-L

With lock

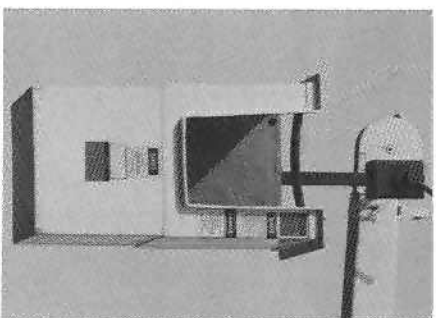

Personnel Platform

This extra strength 3 x 6 foot steel platform will carry up to 1,000 pounds and operate at working heights up to 70 feet. It is hydraulically self-leveling and protected by safety valves. Safety belts included. Fold down sides standard.

Optional manual rotator available for precise placement of the platform. Easy-to-operate crank rotates the platform through a dependable chain drive. Continuous rotation. Locks in position.

The personnel platform must not be operated in load rated areas where the load chart shows capacities less than 1,800 pounds on Model SLP and 1,900 pounds on Model SLP-R.

Model SLP Model SLP-R

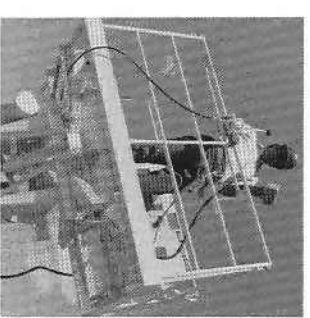

Two Person Basket

Extra capacity steel basket for even greater crane versatility. Swing mounted to self-level. Lever-operated friction brake for stability and locking.

Safety belts included. The basket must not be used in load-rated areas where the crane load chart shows capacities less than 950 pounds. The maximum capacity of the basket is 500 pounds.

Model BS-1

5 ft. yoke

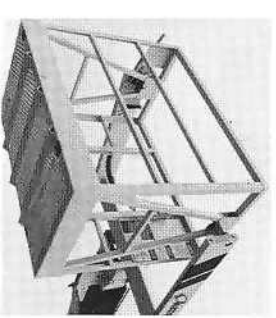

Hydraulic Oil Cooler

Automatic hydraulic device designed to cool the oil under continuous operation.

Model HOC

Stabilizers

We offer a complete range of front and rear stabilizers with hydraulic vertical and horizontal motion. All cylinders are fully enclosed for protection against dirt and on-the-job damage.

Stabilizers

Stabilizers	Vertical Travel	Ground Penetration (38" Frame Height)	Operation	Span
Rear Mounted (Models RSH-15/18/25)	15", 18" or 25"	3" 6" or 13"	All-Hydraulic	6' (RSH-15), 8' (RSH-18/25)
Rear Mounted (Model ASH)	20"	8"	All-Hydraulic	10'
Front Mounted (Model FSH-25 Fixed, SFO Folding*, Model FSHF-25 Folding)	20"	13"	All-Hydraulic	8'
Behind Cab Mounted (Model ASHBC)	20"	7"	All-Hydraulic	10'

Controls All stabilizers noted above can be operated from either crane control station

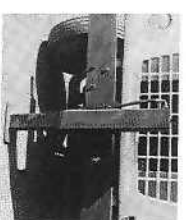

*The SFO, a single front mounted hydraulic stabilizer, is not designed to lift the vehicle, but will provide stability for the vehicle after it has been leveled. The SFO has an 18" vertical stroke.

Cross-frame Outriggers

Outriggers	Extended Span	Retracted Span	Vertical Travel	Over-Frame	Under-Frame	Ground Penetration (38" Frame Height)	Mounting Space	Crane/Outrigger	Outrigger Only	Mounting
Model MKF	15'	6"	7' 11"	25'	18"	10"	60"	Behind	24"	cab, at rear of chassis or both



Pallet Fork

Turns your Series 400 into a versatile, payload-packing fork lift. Great for delivering palletized material right where you want it. 4,400 lbs. (1,814kg) capacity with adjustable throat and teeth. Handles most loads with ease.

Capacity: 4,400 lbs. at 20" center
Throat Opening: (adjustable) 41" to 65"
Tooth Length: 38"
Tooth Width: 33.5" to 57" (outside to outside) min. max.
Weight: 350 lbs.

Model MKF

(Manual leveling, adjustable throat)

Loose Material Clam Bucket

Increase the flexibility of your National crane with a National clam bucket. Use this versatile accessory to load or move up to ½ cubic yard of loose materials with each bite. Hooks easily to loadline, comes with 50 feet of hydraulic hose on automatic reel and quick-connect fittings. Extension hoses are required for use with jibs. Just position the load where you want it and open the bucket.

Model LMC

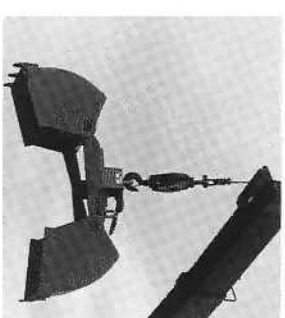

Model AAS
(Audible capacity alert system)
Model HAS
(Hydraulic capacity alert system)

High Pull Planetary Winch

Extra capacity, heavy-duty winch with planetary gear drive for smoothness and strength.

Model PD-12

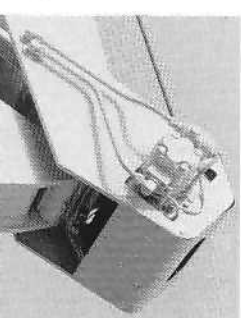

National Series 400 Specifications

General Construction: Low-alloy, high strength steel, including T-1, Ex-Ten, Stress-proof, Hi-Yield, and other steels combined with special, low-hydrogen welding techniques wherever advantageous. Standard color: National Ivory.

Frame: Box construction. Weld-on truck frame mounting brackets form base for crane frame and subbase attachment. Bolt-on optional. Rotation bearing, gearbox, and level indicator mounting surfaces are precision machined after welding to ensure accurate alignment and flat surfaces for prolonged life.

Turret: Fabricated, rigid structure, well-braced for stability. The bearing surface is machined and the pin holes are bored after welding to ensure accurate alignment and flat surfaces for prolonged life.

Rotation: 375° non-continuous. Rotational force 120,000 in./lbs. (600,000 in./lbs. breaking strength). Turret rotation is by hydraulic orbit motor and planetary gearbox driving a pinion. The turret rotates on a ball bearing race. Spring-applied hydraulic release brake provides positive, no-drift lateral positioning.

Outriggers: "A" frame box-type 15-foot span (center of pad at ground level) moves out-and-down, will not bind when raising or lowering truck. Can be positioned to 8 inches below ground level when mounted on truck with a frame height of 38 inches. Outrigger cylinders are equipped with butt-mounted, safety check valves. Equipped with extra large pads to reduce ground pressure loading and for greater stability in soft footing.

Tilt: Double-acting hydraulic cylinder raises and lowers the boom, butt-mounted, safety

holding valve prevents the boom from falling in the event of hose failure. Tough, field-tested bearings in tilt, cylinder and boom pivot combined with micro-honed pins provide long life with reduced maintenance.

Boom: Boxed construction. Telescopes hydraulically in sequence under rated load on nylon plates impregnated with molybdenum disulfide on all sides of boom, permitting maximum loads to be extended at greater radii. Holding valves prevent retraction except under power.

Controls: Dual side, stand-up, with operator platform and foot accelerator identical on both sides. Simultaneous operation of load-line and other operations standard. Horn and stop switch on both sides. Controls easily removable for maintenance.

Winch: Hydraulic motor with planetary gear reduction, brake, and counterbalance valve for "power down" load lowering. 6,450-pound bare drum, single line pull available with 190 feet of 1/2" diameter, 27,500-pound breaking strength on the standard rotation resistant loadline. Optional 1/2" diameter, 23,000-pound breaking strength 6 x 25 IWRC loadline is available. Optional planetary winch is available with 10,200 pounds bare drum, single line pull, 220 feet of 9/16" diameter, rotation resistant, 35,000-pound breaking strength loadline or 9/16" diameter, 6 x 25 IWRC loadline with 29,750-pound breaking strength.

*Because of ANSI safety factor requirements, the standard rotation resistant wire rope is rated at a 7,000-pound, 5:1 single line pull and the optional 6 x 25 IWRC wire rope is rated at an 8,400-pound, 3.5:1 single line pull.

Pump: One Vickers, high-pressure, high speed, balanced vane, replaceable cartridge-type tandem pump independently providing 25 gpm to winch, and 14 gpm to crane for smooth, fast, simultaneous operation.

Cylinders: Shaft packing: Polyurethane U-cup type. Shafts Hi-Yield, stress-relieved, chrome-plated. Piston sets: Polyurethane U-cup and rider construction. Cylinder barrels: Micro-honed tubing, butt-mounted, safety check valves.

Valves: Four-way, spring-centered, spool-type with independent relief valves set at 2,500 psi (maximum 3,050 psi on winch system) to protect circuits against overload.

Hose: All high-pressure hose is wire-braid reinforced, having a minimum safety factor of 4 to 1.

Operating Speeds: Rotation 375°, 35 seconds. Boom up, -15° to 80° 14 seconds. Boom down, 80° to -15°, 14 seconds. Boom extend: 38 fpm. Boom retract: 46 fpm. When using remote control, crane function speeds will be reduced by 50% to assure smooth operation. (Speeds above assume no load with 14 gpm oil flow on boom and 25 gpm on winch.)

Oil Tank Capacities: 32-gallon supply tank. Normally mounted on subframe. Sight gauge, clean-out, and magnetic plug. System has an approximate 45-gallon total capacity.

Filter: 10-micron, replaceable-cartridge, return-line filter. 100% filtration.

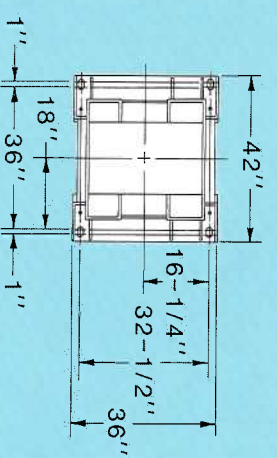
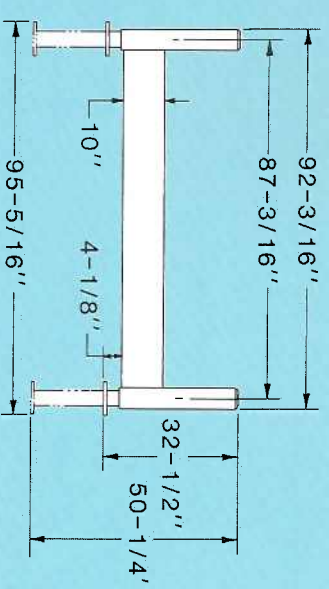
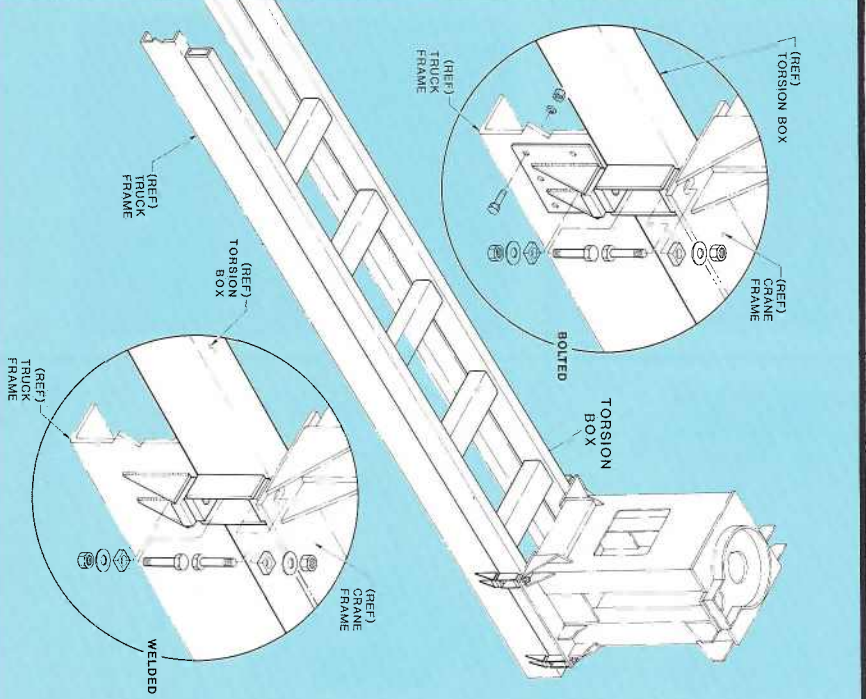

REAR STABILIZER (RS-18)

G CENTER OF GRAVITY

Series	RL	EL	G	*Dry Weight	*W/Oil Weight
455	21'6"	55'	48"	7,130	7,510
446	18'6"	46'	39"	6,820	7,190
437	15'6"	37'	30"	6,510	6,880
428	12'6"	28'	29"	6,230	6,600
426	15'6"	26'	28"	6,100	6,470

*Above weights do not include subbase or rear stabilizers. Standard subbase weight: 1,190 pounds. Rear stabilizer weight: 550 pounds. Subbase dimension: 35" wide x 254" long x 8" high.

