



CROSSOVER 8000

80T capacity class
Boom Truck Crane
Datasheet
imperial

CROSSOVER 8000

PRELIMINARY



Features

- ▶ 80 ton rated capacity @ 10 ft from center of rotation
- ▶ 126 ft maximum boom length
- ▶ 135 ft maximum tip height
- ▶ 33/57 ft optional jib
- ▶ 190 ft maximum tip height with 57 ft jib
- ▶ Tilting operator cab – standard
- ▶ Rated capacity indicator with work area definition

WORKS FOR YOU.™

Page:

Key

.....	3
-------	---

Dimensions































Crane Dimensions	4-5
Selected Crane Configuration Axle Loads	5
Range Diagram	6

Load Charts

Boom	7
Jib	8

Technical Description

Boom, Jib and Rotation	9
Hoists and Rope	9-10
Hydraulics	10
Upper Operator Cab	10
Boom Rotation	11
Counterweight	11
Outriggers	11

	Main boom		Counterweight
	Boom length		Main Hoist
	Tip height		Auxiliary hoist
	Boom with jib		Hoist line speed
	Telescoping mode		Operator aid
	Boom angle		Cab
	Working radius		Chassis Engine Information
	Main boom with aux head		Hydraulics
	Boom head		Heating / Air conditioning
	Hook block		Outriggers
	Hook to head sheave pin		Rotation / Allowable rotation range
	Rope – Standard / Optional		Slewing brake
	Rope diameter		Boom over the rear
	Rope length		Boom over the front
	Permissible line pull		Area of operation
	Maximum line pull		

DIMENSIONS

CROSSOVER 8000

Crane Dimensions

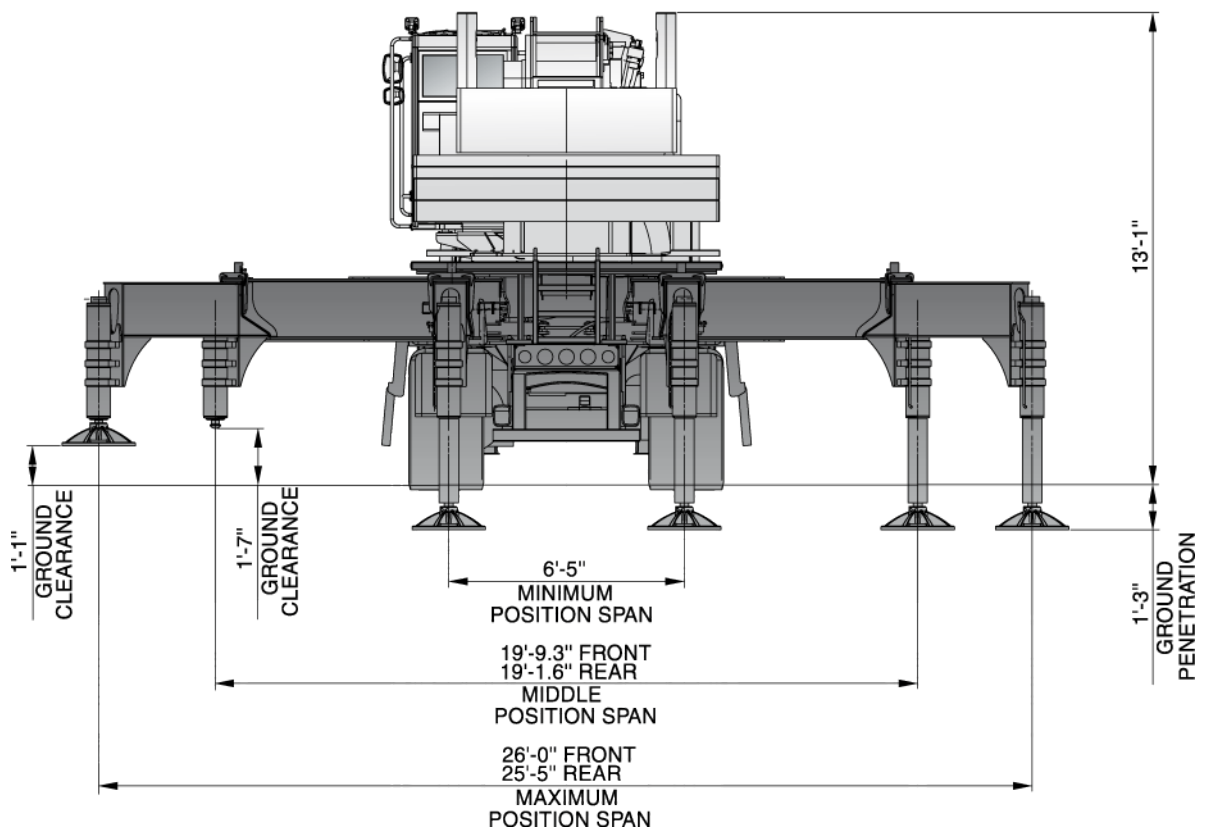
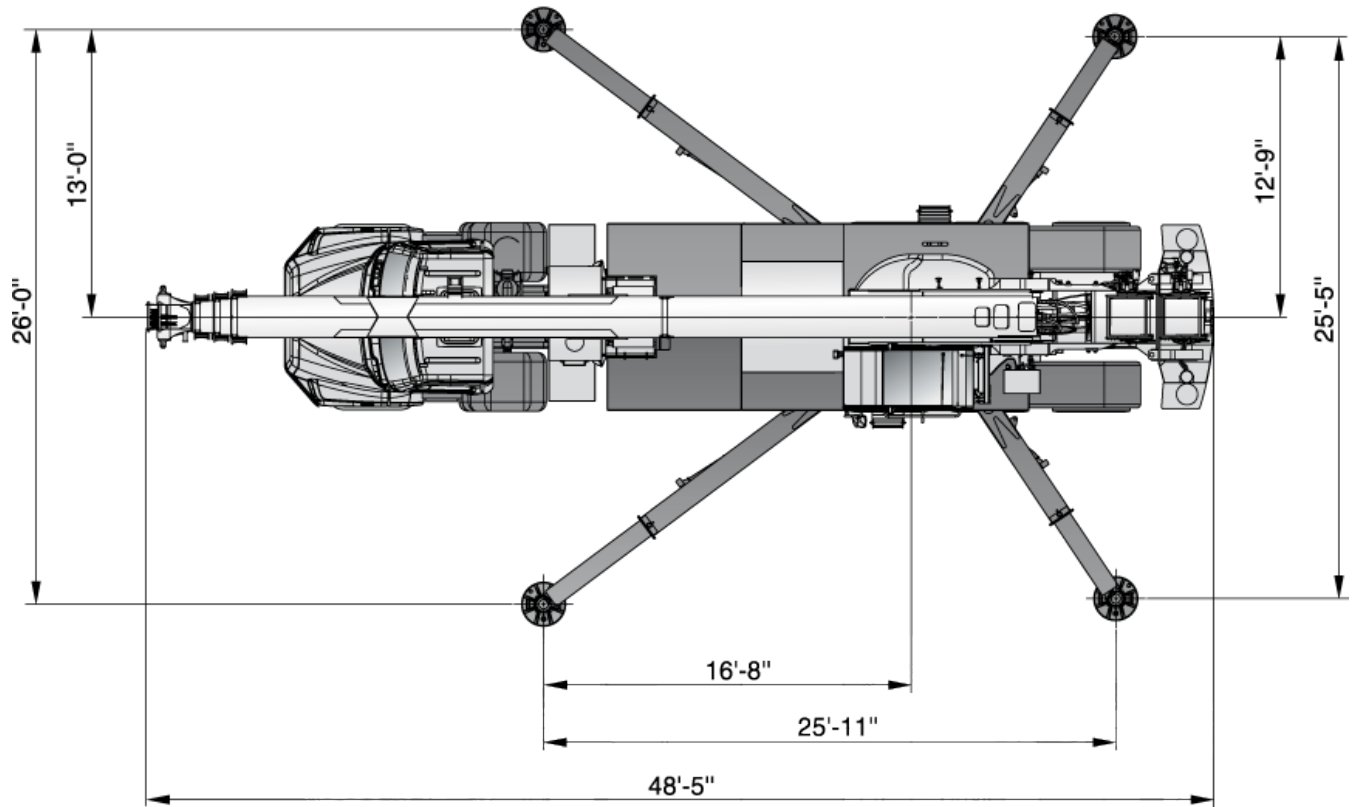

DIMENSIONS

CROSSOVER 8000

Crane Dimensions

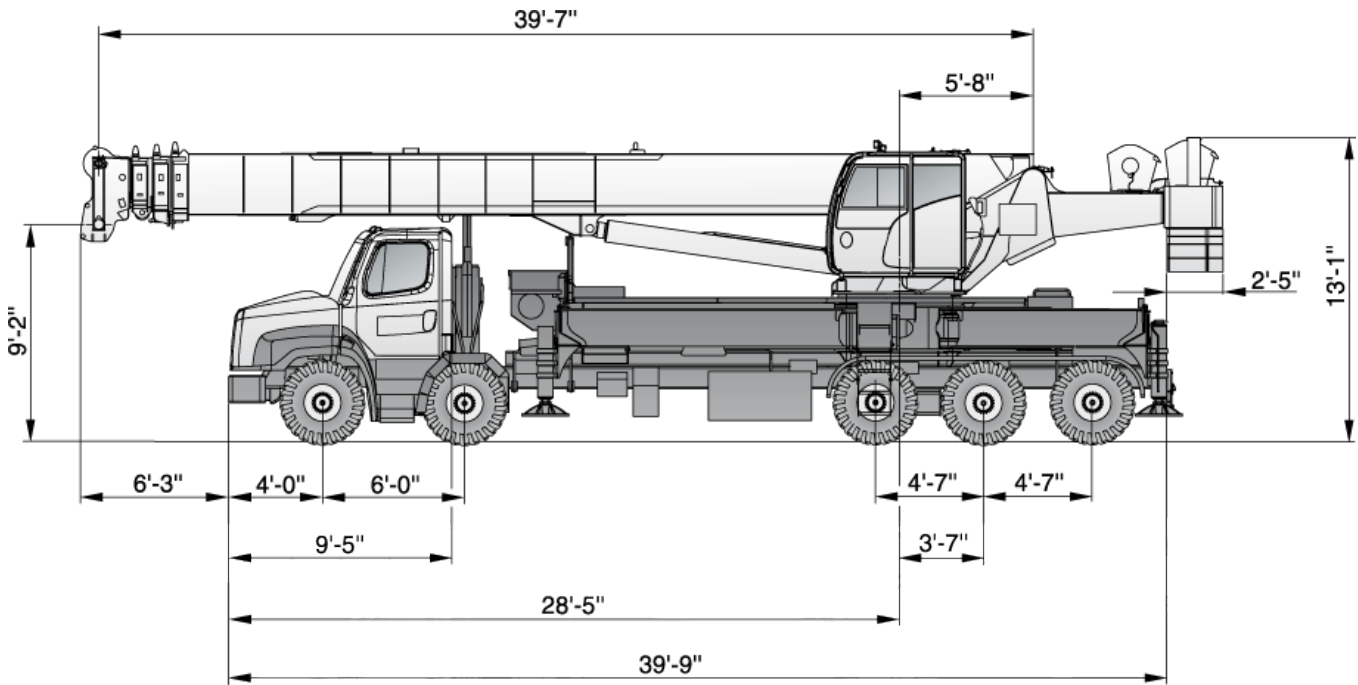

Selected Crane Configuration Axle Loads

Truck Brand	Axle Configuration	Jib	Counter-weight	Auxiliary Winch	Main Hook Block	Gross Vehicle Weight	Total Front Axles Weight	Total Rear Axles Weight
Freightliner	Twin Steer / Tridem		Bare Chassis with no Crane Fitted			24,615 lbs	13,875 lbs	10,740 lbs
Freightliner	Twin Steer / Tridem	None	3,000 lbs	No	75 US ton	84,460 lbs	36,830 lbs	47,630 lbs
Freightliner	Twin Steer / Tridem	33/57 ft	15,000 lbs	Yes	75 US ton	98,850 lbs	34,350 lbs	64,500 lbs
Freightliner	Twin Steer / Tridem		Maximum Allowable Axle Loads			107,680 lbs	39,680 lbs	68,000 lbs

RANGE DIAGRAM

CROSSOVER 8000

Outriggers Fully Extended (100%)

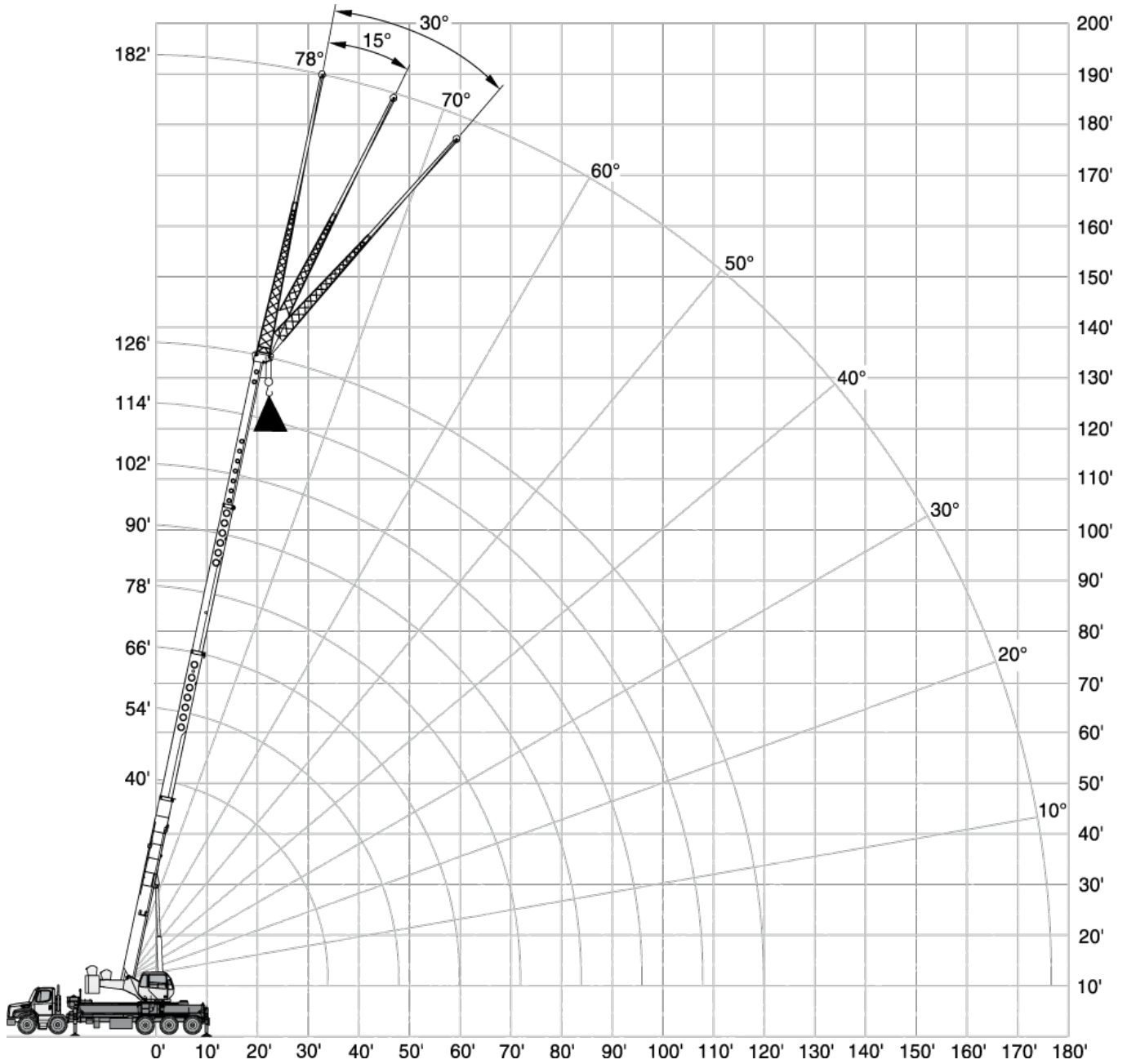
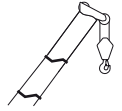

BOOM LOAD CHART

CROSSOVER 8000

Outriggers Fully Extended (100%)



 15,000 lbs

 (100%)

 360°

 40 to 126 ft

Standard ASME
B30.5

	Boom Length								
	40 ft	54 ft	66 ft	78 ft	90 ft	102 ft	114 ft	126 ft	
ft	lbs	lbs	lbs	lbs	lbs	lbs	lbs	lbs	ft
10	160000	102500							10
12	125600	102500	90800						12
15	108800	100500	80600	74100					15
20	84500	85300	71900	62200	56200				20
25	65400	66400	64800	55700	48000	41900			25
30	49000	50400	50800	49700	41700	36400	31500		30
35		38800	39300	39600	36600	32100	29500	24700	35
40		30900	31500	31800	32000	28600	26200	24600	40
45		25200	25800	26200	26400	25700	23500	22100	45
50			21500	21900	22200	22300	21400	20000	50
55			18200	18600	18800	19000	19100	18200	55
60				15900	16100	16300	16400	16500	60
65				13600	13900	14100	14200	14300	65
70				11700	12100	12100	12200	12300	70
75					10500	10500	10600	10700	75
80					9100	9100	9200	9300	80
85						7900	8100	8100	85
90						6800	7000	7100	90
95						5900	6100	6200	95
100							5200	5300	100
105							4500	4600	105
110								3900	110
115								3300	115

Notes to lifting capacity

Lifting capacities do not exceed 85% of tipping load. Weight of hook blocks and slings is part of the load, and is to be deducted from the capacity ratings. Consult operation manual for further details.

Note: Data published herein is intended as a guide only and shall not be construed to warrant applicability for lifting purposes. Crane operation is subject to the computer charts and operation manual both supplied with the crane.

LOAD CHART

CROSSOVER 8000





With Jib, Outriggers Fully Extended (100%)

 15,000 lbs

 (100%)

 360°

Standard ASME
B30.5











57 ft Offsettable Jib						
	0°		15°		30°	
	 ft	lbs	 ft	lbs	 ft	lbs
77	49	6500	65	4500	76	3300
75	56	6400	71	4300	81	3200
73	63	6200	77	4100	87	3100
71	70	6000	83	3900	92	3000
68	80	5400	92	3700	100	2900
65	89	4900	100	3500	107	2800
62	98	4500	108	3300	114	2700
59	106	4200	115	3100	121	2600
55	116	3800	124	2900	129	2500
51	126	3500	132	2800	136	2500
47	134	2900	140	2400	143	2100
43	142	2700	147	2300	149	2100
38	150	2200	154	2000	156	2000
32	159	1700	162	1600	162	1600
25	167	1200	169	1200		
17	173	900	174	900		
0	177	700				

Notes to lifting capacity

Lifting capacities do not exceed 85% of tipping load. Weight of hook blocks and slings is part of the load, and is to be deducted from the capacity ratings. Consult operation manual for further details.





Note: Data published herein is intended as a guide only and shall not be construed to warrant applicability for lifting purposes. Crane operation is subject to the computer charts and operation manual both supplied with the crane.

Boom, Jib and Rotation

	Four-section full power fully synchronized telescopic boom	
	Boom length	Retracted: 40 ft Extended: 126 ft
	Boom maximum tip height	135 ft
	Boom elevation angle range (min. / max.)	-4° / 78°
	Boom head	quick reeving
	360° continuous rotation	
	Load moment / Rated capacity indicator with work area definition ATB system	
Optional		
	Swing-On Jib – fixed length – can be offset to 0°, 15° or 30° Maximum tip height with fixed jib	32 ft 167 ft
	Swing-On Jib – adjustable length – can be offset to 0°, 15° or 30° Maximum tip height with extended jib	33 ft / 57 ft 190 ft
	5 metallic sheaves 5 metallic sheaves Quick reeving design	80 T 60 T
	Top swivel ball with hook and latch	12 T

Hoists and Rope





	Two speeds First layer (no load speed) Fifth layer (no load speed)	Low Speed: 191 ft/min 275 ft/min	High Speed: 335 ft/min 487 ft/min
	First layer Fifth layer	Low Speed: 18,450 lb 12,845 lb	High Speed: 10,002 lb 6,963 lb
	Permissible line pull		13,800 lb
			6 x 19 IWRC XIPS
	Maximum useable		561 ft
			3/4 in

		Optional	
	Two speeds First layer (no load speed) Fifth layer (no load speed)	Low Speed: 191 ft/min 275 ft/min	High Speed: 335 ft/min 487 ft/min
	First layer Fifth layer	Low Speed: 18,450 lb 12,845 lb	High Speed: 10,002 lb 6,963 lb
	Permissible line pull	13,800 lb	
		6 x 19 IWRC XIPS	
		3/4 in	

Hydraulics

	Piston pump:	
	Hoist	60 gal/min @ 4,500 psi
	Boom lift	45.1 gal/min @ 4,500 psi
	Boom telescope	22 gal/min @ 3,500 psi
	Gear pump:	
	Swing / Outrigger / Counterweight / Cab tilt	24 gal/min @ 3,500 psi
	Full flow filtration with bypass protection:	
	Suction	250 micron screen
	Return	5 micron filter
	Pressurized tank with sight level gauge	178 gal

Upper Operator Cab

	Upper cab Sliding door on left side Sliding window on the right side Tilting, tinted glass skylight Removable front windshield Six-way adjustable seat with armrest dual-axis electro-proportional joysticks Joystick control for hoist(s), swing and boom elevation Foot pedals for swing brake and engine rpm Hand control for engine rpm Hydraulic cab tilt
	Optional features for upper cab Air conditioning – hydraulically powered Heater and air conditioning package – hydraulically powered Work lights
	Rated capacity indicator with pictograph display of boom radius, boom angle, boom length, allowable load, actual load and % of allowable load Settable alarms for swing angle, boom length, boom angle, tip height and work area exclusion zone
	Provides operator cab readout of: Diesel fuel and DEF levels, engine status lamps, engine RPM, crane hours-of-operation, coolant temperature, oil pressure and throttle diagnostics

Boom Rotation



Foot pedal actuated multi-disc brake and air actuated 360° house lock



Hydraulic driven double planetary reduction gear drive

2.2 rev/min

Counterweight



Main counterweight, non removable, bolted to upper crane structure
Removable counterweights

3,000 lb counterweight package
2,000 lb / 2,000 lb / 4,000 lb / 4,000 lb

Outriggers



X-pattern

MAX Front: Swing, Out and Down
To outer edge of pad

26 ft

Rear: Swing, Out and Down
To outer edge of pad

25.4 ft

MID Front: Swing, Out and Down
Rear: Swing, Out and Down

19.8 ft

19.5 ft

Effective Date: February 2014.

Product specifications and prices are subject to change without notice or obligation. The photographs and/or drawings in this document are for illustrative purposes only. Refer to the appropriate Operator's Manual for instructions on the proper use of this equipment. Failure to follow the appropriate Operator's Manual when using our equipment or to otherwise act irresponsibly may result in serious injury or death. The only warranty applicable to our equipment is the standard written warranty applicable to the particular product and sale and Terex makes no other warranty, express or implied. Products and services listed may be trademarks, service marks or trade-names of Terex Corporation and/or its subsidiaries in the USA and other countries. All rights are reserved. Terex® is a registered trademark of Terex Corporation in the USA and many other countries.

Copyright Terex Cranes 2014

Terex Cranes, Global Marketing, Dinglerstraße 24, 66482 Zweibrücken, Germany
Tel. +49 (0) 6332 830, Email: info.cranes@terex.com, www.terexcranes.com



www.terexcranes.com

Brochure Reference: TC-DS-I-E-Crossover8000-02/14



TEREX®

WORKS FOR YOU.™