

# LOCATELLI

CRANE



ATC 20 >>

## CARRO

### TELAIO

Scatolato e saldato, costruito con materiali ad alta resistenza.

### STABILIZZATORI IDRAULICI

Indipendenti idraulici con travi ad uscita orizzontale e 4 cilindri verticali con valvole di blocco. 3 modalità di posizionamento 0% 50% 100%.

### MOTORE

Turbo Diesel IVECO N67ENTX20, sei cilindri in linea, raffreddamento ad acqua. Potenza max 175 kW a 2200 giri/min. Coppia max 1020 Nm a 1.500 giri/min. Filtro aspirazione aria a secco con cartuccia di sicurezza e indicatore di intasamento con segnalazione in cabina. Capacità serbatoio carburante 250 L.

### TRASMISSIONE

Idrostatica a 2 velocità. Controllo elettronico della trazione con modalità automatica di passaggio dalle marce lente a quelle veloci.

### POMPE IDRAULICHE

Pompa a cilindrata variabile con comando elettrico proporzionale per la trasmissione. Pompa a cilindrata variabile load sensing per manovre braccio e argano. Pompa ad ingranaggi per comandi sterzo, stabilizzatori, sospensioni e rotazione.

### ASSI

Anteriore e posteriore traenti e sterzanti con differenziale e riduzioni planetarie fissati al telaio con barre di reazione. Bloccaggio differenziale su entrambi gli assi.

### SOSPENSIONI

Idropneumatiche indipendenti, bloccabili con comando in cabina; livellamento automatico per marcia su strada.

### STERZO

Elettrico per la modalità fuoristrada e meccanico servo-assistito per la marcia stradale. Quattro possibilità di sterzata: solo ruote anteriori; solo ruote posteriori; coordinate; a granchio. Blocco idraulico dello sterzo posteriore per marcia su strada con comando in cabina.

### FRENI

A doppio circuito indipendente a comando pneumatico con sistema antibloccaggio ABS e freno di parcheggio. Freno motore con comando a pedale in cabina.

### PNEUMATICI

365/85 R20, montati in singolo, adatti per un impiego su strada e fuoristrada.

### IMPIANTO ELETTRICO

Di avviamento e illuminazione a 24 Volt conforme alla normativa CE.

### ACCESSORI PRINCIPALI A RICHIESTA

- Prolunga telescopica inclinabile da 8,0 m
- Montante industriale da 1,15 m
- Gancio a palla da 3.000 kg
- Bozzello a 3 carrucole da 12.500 kg
- Bozzello ad ancora a 5 carrucole da 20.000 kg

## TORRETTA

### STRUTTURA TORRETTA

Costruita con piastre e profilati in acciaio ad alta resistenza.

### BRACCIO TELESCOPICO

A 6 sezioni. Braccio a sfilamento completamente idraulico sincronizzato da 5,6 m a 23,8 m a controllo elettronico. Altezza massima testa braccio 26,0 m.

### SOLLEVAMENTO BRACCIO

Cilindro idraulico a singolo effetto. Elevazione da  $-9^\circ$  a  $+80^\circ$ .

### ROTAZIONE TORRETTA

Rotazione continua su  $360^\circ$ . Motore idraulico con riduttore a doppia riduzione epicicloideale. Freno di rotazione automatico a dischi multipli. Sistema a rotazione libera. Ralla a dentatura esterna. Bloccaggio pneumatico rotazione con comando dalla cabina di guida.

### ARGANO

Posto direttamente sul braccio. Motore idraulico a pistoni accoppiato a riduttore a doppia riduzione epicicloideale. Tamburo scanalato. Freno automatico a dischi multipli e valvola di controbilanciamento.

### CABINA

Costruita in acciaio. Visibilità panoramica e completa di ampi vetri di sicurezza. Sedile dell'operatore scorrevole e regolabile in altezza e profondità. Specchi retrovisori esterni riscaldati e regolabili elettricamente.

### COMANDI GRU

Manipolatori elettrici proporzionali montati sui braccioli del sedile operatore per il comando indipendente o simultaneo dei movimenti gru. Sistema integrato di controllo dei comandi. Il limitatore di carico e i movimenti della gru sono controllati elettronicamente (LOCATRONIC).

### DISTRIBUTORI

Distributori idraulici proporzionali load sensing che garantiscono la combinazione simultanea dei movimenti della gru.

### COMANDI DI TRASLAZIONE GRU

Volante inclinabile per il comando della sterzata delle ruote anteriori. Interruttore elettrico per la sterzata indipendente delle ruote posteriori. Selettore per il cambio di velocità, l'inversione di direzione e il freno di parcheggio. Interruttore elettrico per abilitazione marcia stradale/fuoristrada. Strumentazione per la diagnostica motore.

### DISPOSITIVI DI SICUREZZA

Fincorsa salita e discesa gancio. Valvole di blocco su tutti i cilindri idraulici. Valvole di massima pressione su tutti i circuiti idraulici.

- Faro di lavoro (cabina e sezione base del braccio)
- Radiocomando
- Climatizzatore in cabina
- Ruota di scorta
- Sistema di ingrassaggio automatico carro

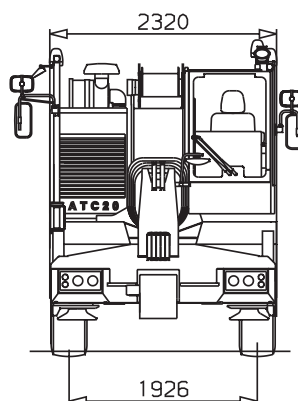
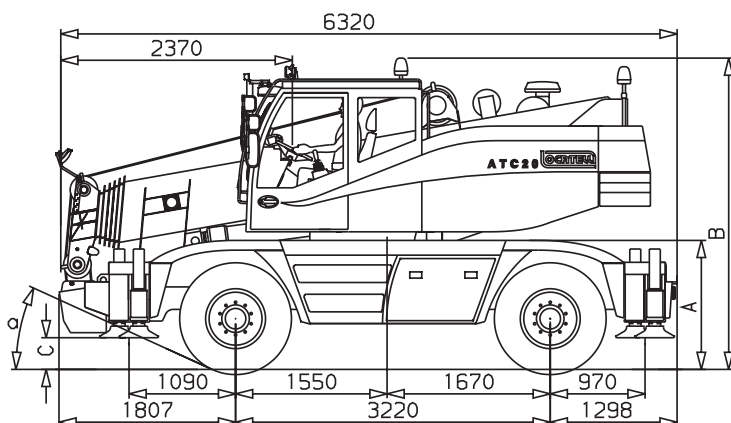

	A (mm)	B (mm)	C (mm)	(mm)
max	1410	3270	410	28,5°
stradale / drive	1330	3190	330	24,5°
min	1240	3100	240	19,5°

**Dimensioni (mm)**

## CHASSIS

### CHASSIS

Heavy duty, all welded box type section frame.

### OUTRIGGERS

Four independent hydraulically operated and automatically synchronized telescopic outrigger beams with vertical hydraulic jacks and lock valves. Extension lockable in 3 positions 0%, 50%, 100% .

### ENGINE

Turbo Diesel IVECO N67ENTX20, six cylinders turbocharged intercooler diesel engine and water cooled. Max. power 175 kW at 2.200 rpm. Max. torque 1.020 Nm at 1.500 rpm. Dry type air cleaner with safety cartridge and service indicator. Fuel tank capacity 250 L.

### TRANSMISSION

Hydrostatic with 2 speeds. Fully electronic drive control for fast and slow driving.

### HYDRAULIC PUMPS

Variable flow piston pump for driving. Load sensing variable flow piston pump for derricking, hoisting and telescoping. Continuous flow pump for steering, outriggers, suspensions and slewing.

### AXLES

Front and rear driving/steering axles with differential and planetary reduction constrained to the frame by reaction bars. Differential lock-out on both axles.

### SUSPENSIONS

Adjustable, hydropneumatically operated independent suspensions; automatic levelling for road travel.

### STEERING

Electrical steering for the off-road mode. Hydraulic power assisted steering and mechanical connection shaft for on road driving. Four steering modes: only front, only rear, coordinated and crab steering. Positive lock to held in center line rear wheels for road travel by control in the cab.

### BRAKES

Air controlled, dual independent braking system, with ABS and parking brake. Engine retarder .

### TYRES

365/85 R20 single mounted front and rear, suitable for on- and off-road operation.

### ELECTRICAL EQUIPMENT

24 volt starting and lighting equipment according to EC traffic regulations.

### MAIN OPTIONAL EQUIPMENT

- 8,0 m offsetable telescopic extension
- 1,15 m runner
- Single hook 3.000 kg capacity
- Hookblock 12.500 Kg
- Anchor hookblock 20.000 Kg

R1:  
4 ruote sterzate  
4 wheels steered

## SUPERSTRUCTURE

### SUPERSTRUCTURE FRAME

Fabricated from high tensile steel plate.

### BOOM

6 sections 5,6 m to 23,8 m automatically synchronised fully powered telescoping boom. Electronically controlled synchronization of boom. Max. boom head height 26,0 m.

### BOOM ELEVATION

Single hydraulic cylinder. Elevation from -9° to +80°.

### SLEW

360° continuous rotation. Hydraulic motor driving slewing pinion through planetary double reduction unit. Spring applied, hydraulically released multidisc type slew brake. Free swing device. External gear teeth slew ring. Hand operated slewing lock, controlled from the operator's cab.

### MAIN HOIST

Boom mounted. Twin piston type hydraulic motor, driving grooved hoist drum through double reduction gear unit. Spring applied, automatically released fail-safe hoist brake and counterbalance valve.

### OPERATOR'S CAB

All steel construction , with air conditioner and auto radio. Safety glass and operator's seat on slides with height and rake adjustment. External heated rear-view mirrors and electrically adjustable.

### CRANE CONTROLS

Armrest mounted joysticks for independent or simultaneous operation of crane motions. Integrated control system. Crane motions and the safe load indicator are electronically controlled by the LOCATRONIC system.

### CONTROL VALVES

Load sensing proportional valve banks permitting simultaneous control of multiple crane functions.

### TRAVEL CONTROLS

Adjustable steering wheel for control of front steering axle. Electric switch for independent steering of rear axle. Transmission gear selection, forward-reverse shift and parking brake control. Control switch for on- and off-road drive. Master gauge for engine diagnostic.

### SAFETY DEVICES

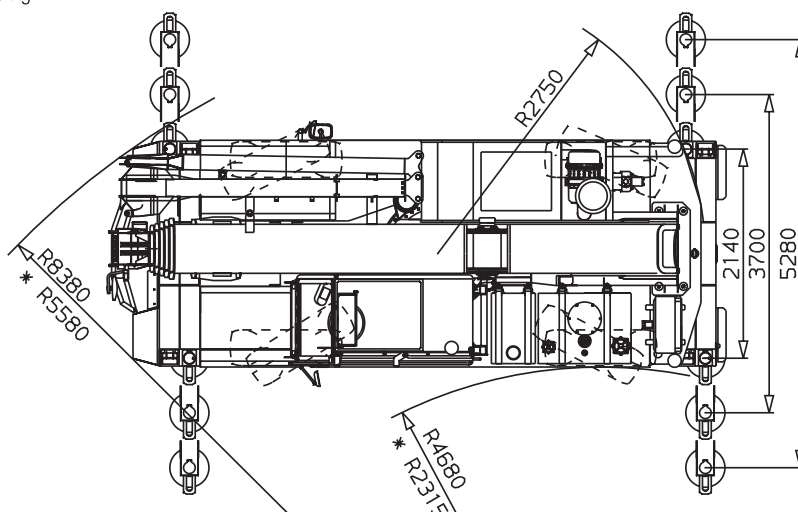

Overhoist and overlower limit switches; lock valves on all cylinders; hydraulic overload valves on all systems.

- Working lights (on cabin and base boom element)
- Remote control
- Air conditioned
- Spare tyre
- Automatic centralized lubrication for the chassis





**Dimensions (mm)**

## PORTATE BRACCIO TELESCOPICO - LIFTING CAPACITIES TELESCOPIC BOOM - CAPACITES DE LEVAGE FLECHE TELESCOPIQUE - TRAGLASTEN TELESKOPAUSLEGER - CAPACIDADES DE CARGA PLUMA TELESCOPICA

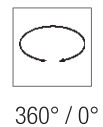
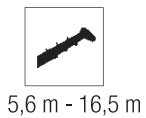
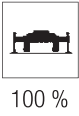
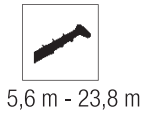
 m	9,2 m	12,8 m	16,5 m	20,1 m	23,8 m	 m
	TELE %	TELE %	TELE %	TELE %	TELE %	
	1-0-0-0-0	1-1-0-0-0	1-1-1-0-0	1-1-1-0.5-0.5	1-1-1-1-1	
2,5	20,0	14,5	11,2	9,5		2,5
3,0	18,5	14,5	11,2	9,5	6,5	3,0
3,5	16,5	13,6	11,0	9,0	6,5	3,5
4,0	14,0	12,7	10,3	8,6	6,5	4,0
4,5	12,2	11,6	9,7	8,2	6,2	4,5
5,0	10,6	10,6	9,1	7,7	6,0	5,0
6,0	8,4	8,3	8,0	6,9	5,6	6,0
7,0		6,8	7,0	6,2	5,2	7,0
8,0		5,6	5,8	5,6	4,7	8,0
9,0		4,4	4,7	5,0	4,4	9,0
10,0			3,8	4,2	4,0	10,0
11,0			3,1	3,5	3,7	11,0
12,0			2,6	2,9	3,2	12,0
13,0			2,1	2,5	2,7	13,0
14,0				2,1	2,3	14,0
15,0				1,8	2,0	15,0
16,0				1,5	1,7	16,0
17,0				1,3	1,5	17,0
18,0					1,3	18,0
19,0					1,1	19,0
20,0					1,0	20,0
21,0					0,8	21,0



 m	0 km/h				3 km/h				 m
	360°				0°				
	5,6 m	9,2 m	12,8 m	16,5 m	5,6 m	9,2 m	12,8 m	16,5 m	
	TELE %	TELE %	TELE %	TELE %	TELE %	TELE %	TELE %	TELE %	
	0-0-0-0-0	0-1-0-0-0	0-1-1-0-0	0-1-1-0.5-0.5	0-0-0-0-0	0-1-0-0-0	0-1-1-0-0	0-1-1-0.5-0.5	
2,0					9,1				2,0
2,5					7,7				2,5
3,0	4,5	4,3			6,7	6,2			3,0
3,5		3,6	3,7			5,4	5,4		3,5
4,0		3,0	3,2			4,7	4,7		4,0
4,5		2,6	2,7			4,1	4,2		4,5
5,0		2,2	2,4	2,6		3,7	3,7	3,9	5,0
6,0		1,5	1,8	2,0		3,0	3,0	3,2	6,0
7,0			1,3	1,5			2,5	2,7	7,0
8,0			0,9	1,1			1,9	2,1	8,0
9,0			0,6	0,9			1,5	1,7	9,0
10,0			0,5	0,6			1,2	1,4	10,0
11,0				0,5				1,2	11,0
12,0								1,0	12,0
13,0								0,8	13,0
14,0								0,6	14,0



## DIAGRAMMA DI LAVORO - WORKING DIAGRAM - DIAGRAMME DE TRAVAIL - ARBEITSBEREICH - DIAGRAMA DE TRABAJO

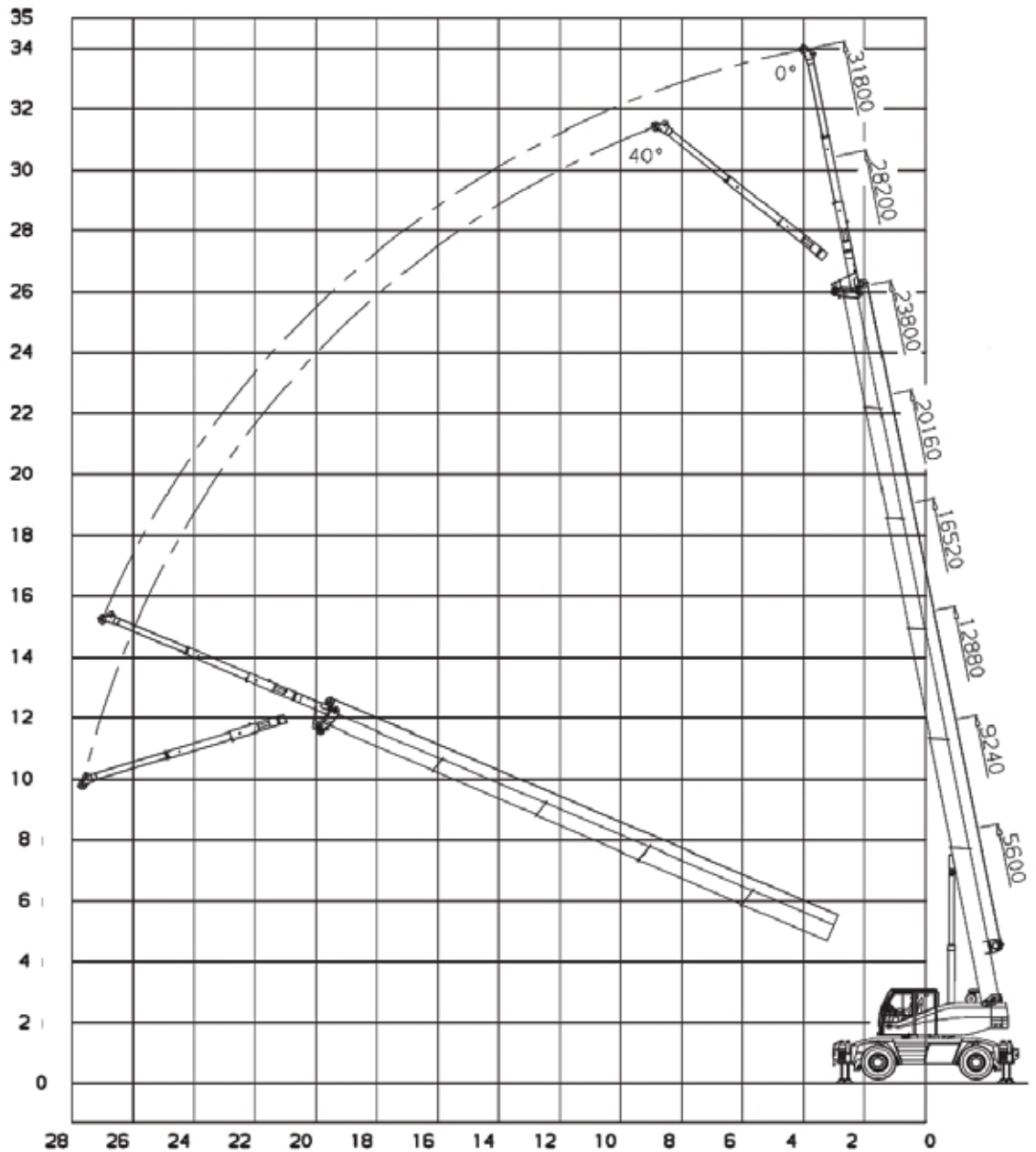
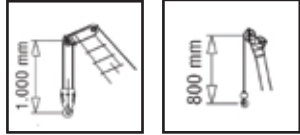

### NOTE SULLA TABELLA DI PORTATE



- I carichi riportati nella tabella di portata sono a norme CE.
- Le portate sono indicate in tonnellate.
- Il peso dei bozzelli, delle prolunghie braccio, delle imbracature e di qualsiasi altra attrezzatura di sollevamento deve essere detratto dalle portate indicate in tabella per ottenere il carico netto sollevabile.
- I raggi di lavoro sono misurati dal centro della ralla di rotazione.
- Per lunghezze di braccio e/o raggi di lavoro non elencati, usare il carico minore corrispondente alla lunghezza di braccio e/o al raggio di lavoro immediatamente successivi.
- Le portate su stabilizzatori sono valide solo se tutte le travi degli stabilizzatori sono completamente estese e la gru, accuratamente livellata, appoggia su una superficie di supporto solida.
- Le portate su pneumatici sono valide a condizione che i pneumatici siano gonfiati alla pressione prescritta e che la gru operi su un terreno piano, solido ed orizzontale:
  - per le portate statiche su 360° l'oscillazione dell'assale posteriore deve essere bloccata,
  - per le portate frontali in traslazione il fermo di blocco della rotazione deve essere inserito e la marcia con il carico sospeso deve essere eseguita con il carico leggermente sollevato da terra, prossimo alla gru, evitando oscillazioni del carico.

### NOTES TO LOAD CHARTS



- The tabulated lifting capacities comply with the CE standards.
- Lifting capacities are given in metric tons.
- The weight of the hookblocks, boom extensions, sling and all auxiliary lifting devices must be deducted from the lifting capacities to obtain the net load to be lifted.
- Working radii are measured from the slewing centreline.
- For boom lengths and/or radii not listed use the smallest load given for the next longer boom length and/or radius.
- The capacities on outriggers are valid only if all outrigger beams are fully extended and the crane accurately levelled on a firm supporting surface.
- The capacities on tyres are valid only if the tyres are inflated to the recommended pressure and the crane works on a flat, solid and horizontal surface:
  - for 360° static lifting capacities the rear axle oscillation must be locked.
  - for over front travelling capacities the swing lock pin must be fully engaged and the travel with suspended load should be carried out with the load little raised from the ground, close to the crane and avoiding load oscillations.

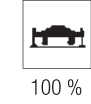
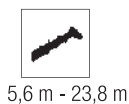
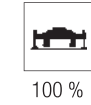
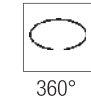
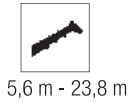

## PORTATE PROLUNGA - LIFTING CAPACITIES BOOM EXTENSION - CAPACITES DE LEVAGE FLECHETTE TRAGLASTEN KLAPPSPITZE - CAPACIDADES DE CARGA PLUMIN

 m	5,6 m		9,2 m		12,8 m		16,5 m		20,1 m		23,8 m		 m
	8,0 m		8,0 m		8,0 m		8,0 m		8,0 m		8,0 m		
	0-0-0-0		1-0-0-0		1-1-0-0		1-1-1-0		1-1-1-0.5-0.5		1-1-1-1		
	0°	40°	0°	40°	0°	40°	0°	40°	0°	40°	0°	40°	
2,0	2,8		3,0										2,0
2,5	2,5		3,0		3,0								2,5
3,0	2,4		2,8		3,0		3,0						3,0
3,5	2,2		2,6		3,0		3,0		3,0				3,5
4,0	2,1		2,5		2,8		3,0		3,0		2,3		4,0
4,5	1,9		2,4		2,6		2,8		2,8		2,2		4,5
5,0	1,8		2,2		2,4		2,6		2,7		2,1		5,0
6,0	1,5	1,0	2,0	1,1	2,3		2,4		2,5		2,0		6,0
7,0	1,3	1,0	1,8	1,0	2,1	1,1	2,3		2,3		1,9		7,0
8,0	1,2	0,9	1,6	1,0	1,9	1,0	2,1	1,0	2,2	1,0	1,8		8,0
9,0	1,0	0,8	1,4	0,9	1,6	1,0	1,9	1,0	2,0	1,0	1,7	1,0	9,0
10,0	0,9	0,8	1,3	0,9	1,5	0,9	1,7	1,0	1,8	1,0	1,6	1,0	10,0
11,0			1,1	0,8	1,4	0,9	1,6	0,9	1,7	0,9	1,5	1,0	11,0
12,0			1,0	0,8	1,3	0,8	1,5	0,9	1,6	0,9	1,4	0,9	12,0
13,0			0,9	0,8	1,2	0,8	1,4	0,9	1,5	0,9	1,3	0,9	13,0
14,0					1,1	0,8	1,3	0,8	1,4	0,9	1,2	0,9	14,0
16,0					1,0	0,8	1,1	0,8	1,3	0,8	1,1	0,9	16,0
18,0							1,0	0,8	1,1	0,8	0,9	0,8	18,0
20,0							0,9	0,8	1,0	0,8	0,7	0,8	20,0
22,0									0,8	0,8	0,6	0,8	22,0
24,0									0,6	0,6	0,5	0,7	24,0
26,0											0,4	0,5	26,0
27,0											0,4	0,4	27,0



 m	5,6 m			9,2 m			12,8 m			16,5 m			20,1 m			23,8 m			 m
	1,15 m			1,15 m			1,15 m			1,15 m			1,15 m			1,15 m			
	0-0-0-0			1-0-0-0			1-1-0-0			1-1-1-0			1-1-1-0.5-0.5			1-1-1-1			
	- 15°	0°	20°	- 15°	0°	20°	- 15°	0°	20°	- 15°	0°	20°	- 15°	0°	20°	- 15°	0°	20°	
2,0	7,4	8,7	11,6	8,9	11,0		9,5	12,0		9,4	10,5		8,8			6,0			2,0
2,5	7,2	8,1	10,3	8,4	10,3		9,3	11,6		9,2	10,5		8,7	9,0		5,7			2,5
3,0	6,8	7,5	9,3	8,1	9,7	14,0	9,0	11,0		9,1	10,5		8,6	9,0		5,4	6,0		3,0
3,5	6,5	7,1	8,4	7,7	9,3	12,8	8,7	10,5		9,0	10,5		8,4	8,5		5,2	5,7		3,5
4,0				7,4	8,8	12,0	8,4	10,0		8,9	9,8		8,0	8,1		5,0	5,5		4,0
4,5				7,2	8,2	11,0	8,1	9,6		8,8	9,2		7,6	7,7		4,7	5,3		4,5
5,0				7,1	7,7	10,3	7,9	9,4	10,2	8,6	8,7		7,3	7,3		4,6	5,2		5,0
6,0				6,7	7,2	8,3	7,4	8,2	8,1	7,8	7,7		6,6	6,6		4,3	4,7		6,0
7,0				6,4	6,8	6,7	6,7	6,6	6,5	6,7	6,7	6,6	6,0	6,0		4,1	4,4		7,0
8,0							5,6	5,5	5,4	5,6	5,6	5,5	5,5	5,5		3,9	4,1		8,0
9,0							4,6	4,5	4,4	4,7	4,5	4,5	4,9	4,9	4,7	3,7	3,8		9,0
10,0							3,7	3,6	3,6	3,9	3,9	3,8	4,2	4,1	4,1	3,5	3,6		10,0
11,0										3,2	3,2	3,1	3,5	3,5	3,4	3,3	3,4	3,6	11,0
12,0										2,6	2,6	2,6	2,9	2,9	2,8	3,1	3,1	3,0	12,0
13,0										2,2	2,2	2,2	2,5	2,5	2,4	2,7	2,6	2,6	13,0
14,0										1,8	1,8	1,8	2,1	2,1	2,0	2,3	2,3	2,2	14,0
16,0													1,5	1,5	1,5	1,7	1,7	1,6	16,0
18,0																1,3	1,3	1,2	18,0
20,0																0,9	0,9	0,9	20,0
21,0																0,8	0,8	0,8	21,0

## DATI TECNICI - SPECIFICATIONS - CARACTERISTIQUES - TECHNISCHE DATEN - DATOS TECNICOS



Peso sugli assali Axle loads Poids d'essieux Achslasten Carga por eje	1	2	Peso totale Total weight Poids total Gesamtgewicht Peso total
t	8	10	18



	stradale / on road (forward and reverse)	fuoristrada/ off road (forward and reverse)
km/h  4x4	24	18
km/h  4x2	73	/
	20%	50%



Funzioni Mechanisms Mécanismes Antriebe Mecanismos	Progressivamente variabile Infinitely variable Progressivement variable Stufenlos Infinitamente variable	Diametro / Lunghezza fune Rope diameter / Rope length Diamètre / longueur du câble Seil ø / Seillänge Diámetro cable / longitud cable	Tiro max. ammissibile Max. permissible line pull Effort max. admis sur brin Max. zulässiger Seilzug Carga max. por reenvío
	0 - 87,3 m/min	12 mm x 117 m	24 kN
	0 - 2,8 min <sup>-1</sup>		
	-9,5° / +80°	↑ 42 s ca. / 42 s approx. ↓ 75 s ca. / 75 s approx.	
	5,6 m - 23,8 m	85 s ca. / 85 s approx.	



Portata Lifting capacity Force de levage Traglast Capacidad de carga	N° di carrucole No of sheaves Nbr de poulies N° der Rollen No de poleas	N° di taglie No of lines Nbr de brins Strangzahl No de reenvíos	Peso Weight Poids Gewicht Peso
20 t	5	10	220 kg
12,5 t	3	7	160 kg
3 t	-	1	170 kg

## Simboli - Symbols - Symboles - Symbolen - Simbolos



Braccio telescopico  
Telescopic boom  
Flèche télescopique  
Teleskopausleger  
Pluma telescópica



Prolunga braccio  
Boom extension  
Rallonge de flèche  
Klappspitze  
Extensión de pluma



Stabilizzatori  
Outriggers  
Calage  
Abstützungen  
Estabilizadores



Pneumatici  
Tyres  
Pneumatiques  
Bereifung  
Neumáticos



Rotazione  
Slewing  
Orientation  
Drehwerk  
Giro



Contrappeso  
Counterweight  
Contrepoids  
Gegenwicht  
Contrapeso



Raggio  
Radius  
Portée  
Ausladung  
Radio



Marcia  
Gear  
Rapport  
Gang  
Marcha



Gamma lenta  
Low range  
Gamme basse  
Gelände  
Gama lenta



Gamma veloce  
High range  
Gamme haute  
Strasse  
Gama alta



Argano principale  
Main hoist  
Treuil principal  
Haupthubwerk  
Cabrestante principal



Argano ausiliario  
Auxiliary hoist  
Treuil auxiliaire  
Hilfshubwerk  
Cabrestante auxiliar



Sfido braccio  
Boom telescoping  
Télescopage de flèche  
Teleskopieren  
Telescopaje de pluma



Elevazione braccio  
Boom elevation  
Relevage de flèche  
Wippwerk  
Elevación de pluma



Bozzello  
Hookblock  
Crochet moufle  
Hachenflasche  
Gancio



» [www.locatell Crane.com](http://www.locatell Crane.com)



**LOCATELLI CRANE srl**

Via Lombardia n. 32 - 24030 Mapello (BG) - Italy - Tel. +39 035 4945066 - Fax +39 035 4945549 - [info@locatell Crane.com](mailto:info@locatell Crane.com)