

# Potain MCT 88

## Data Sheet

FEM 1.001-A3

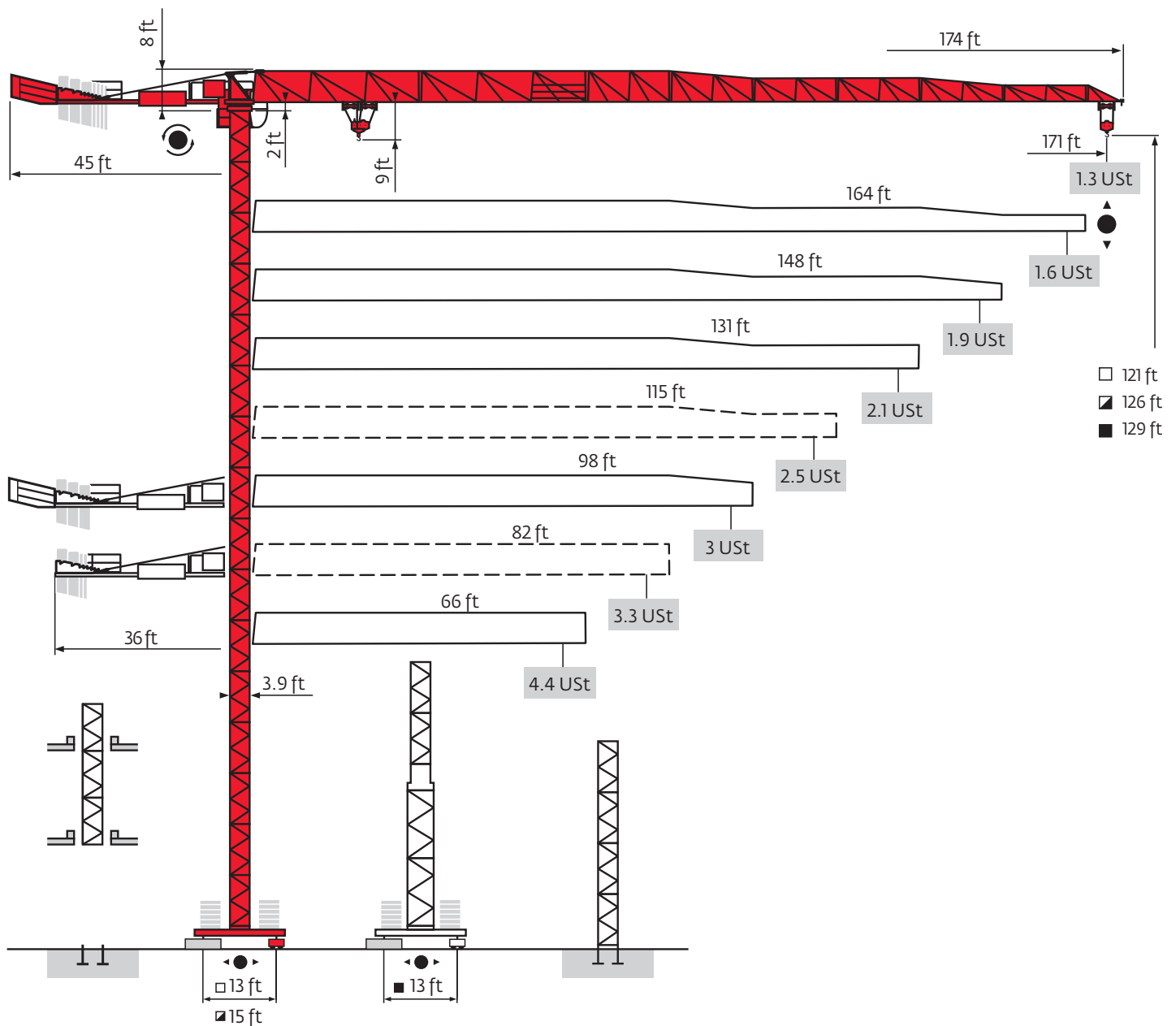

Values have been rounded

# Mast

□ 3.9 ft



66 ft → 171 ft

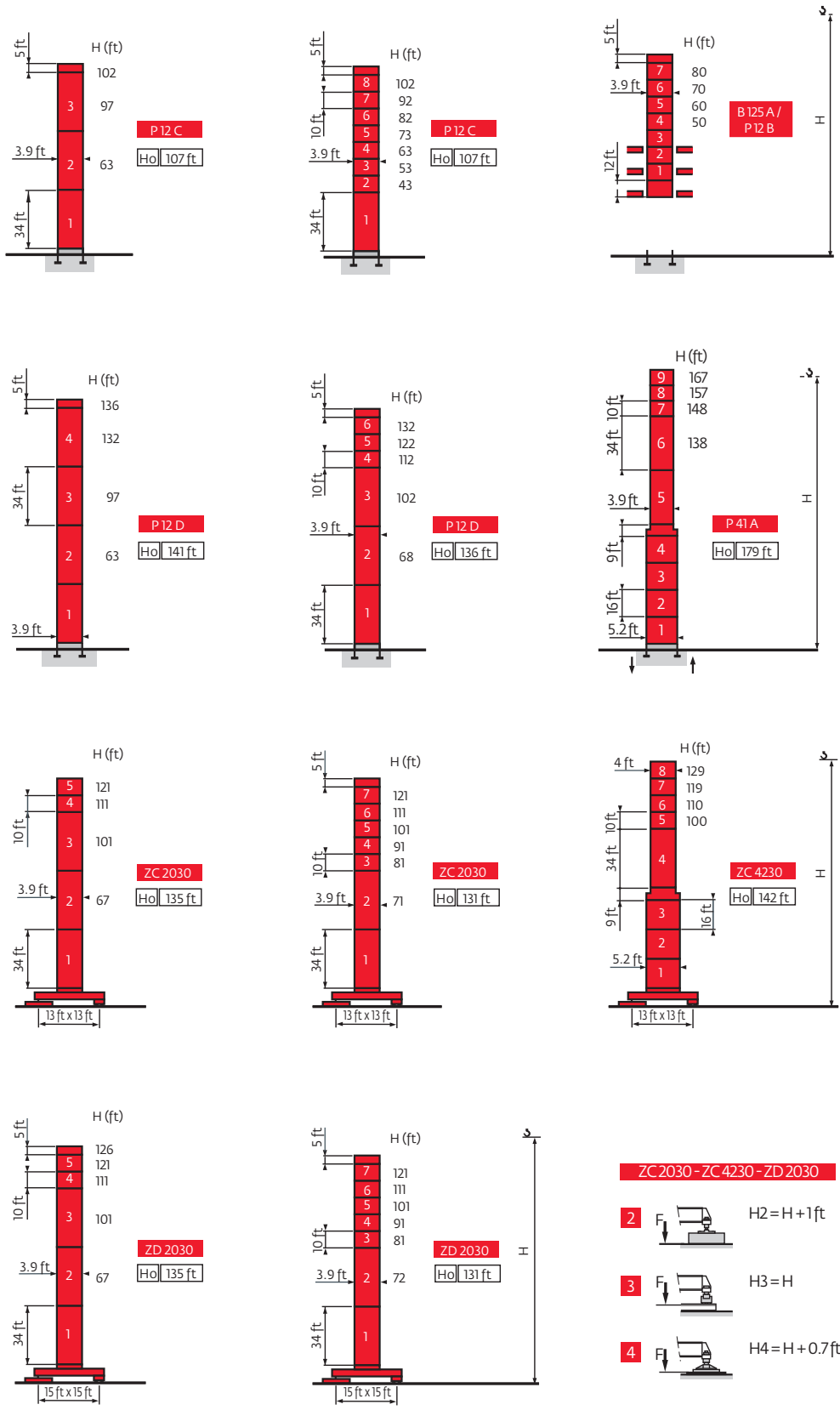

ZC 2030 - ZC 4230 - ZD 2030

- 2 H2 = H + 1 ft
- 3 H3 = H
- 4 H4 = H + 0.7 ft

**Ho** H without cab  
 See climbing crane

# Load charts

Height (ft)	10	45	49	56	66	72	75	80	82	87	89	98	105	115	121	131	138	148	154	164	171	ft
171 ft	USt / 5.5	5	4.3	3.5	3.1	-	2.8	-	2.8	2.7	2.4	2.2	2	1.9	1.7	1.6	1.4	1.4	1.3	1.2	USt	
	USt				3.3	-	3	-	2.8	2.4	2.3	2	1.9	1.8	1.7	1.5	1.4	1.3	1.3	USt		
164 ft	USt / 5.5	5.1	4.2	3.7	3.2	-	2.9	2.8	-	2.8	2.6	2.4	2.2	2	1.9	1.8	1.7	1.5	USt			
	USt				3.3	3.3	-	2.9	-	2.7	2.4	2.3	2.1	2	1.8	1.7	1.6	USt				
148 ft	USt / 5.5	5.3	4.3	3.9	3.3	3	-	2.8	-	2.8	2.7	2.4	2.3	2.1	2	1.8	USt					
	USt				3.3	-	3	-	2.8	2.5	2.4	2.1	2	1.9	USt							
131 ft	USt / 5.5	5.3	4.3	3.9	3.3	3	-	2.8	-	2.8	2.7	2.4	2.3	2.1	USt							
	USt				3.3	-	3	-	2.8	2.5	2.4	2.1	USt									
115 ft	USt / 5.5	5.3	4.3	3.9	3.3	3	-	2.8	-	2.8	2.7	2.4	USt									
	USt				3.3	-	3	-	2.8	2.5	USt											
98 ft	USt / 5.5	5.3	4.3	3.9	3.3	3	-	2.8	2.8	USt												
	USt				3.3	-	3	USt														
82 ft	USt / 5.5	5.3	4.3	3.9	3.3	USt																
	USt				3.3	USt																
66 ft	USt / 5.5	5.3	4.4	USt																		
	USt			3.3	USt																	

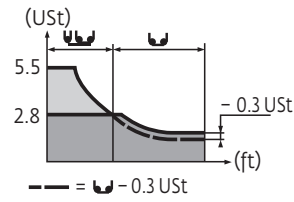

# Climbing crane

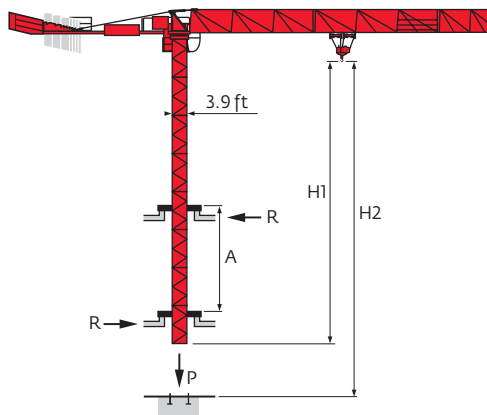



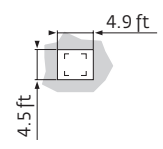
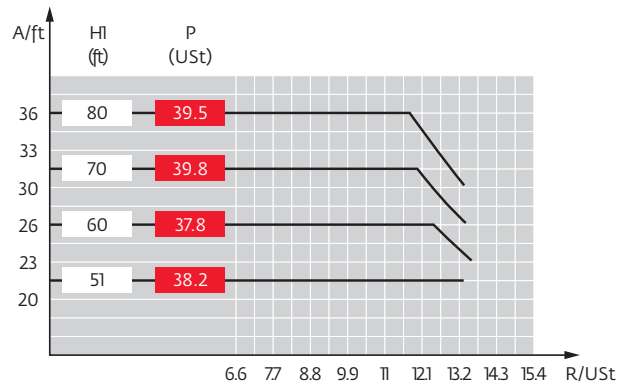







**B 125 A**



**A** Distance between collars  
**H1** Crane height  
**P** Crane weight (in service)  
**R** Horizontal reaction

# Mechanisms

												hp	kW														
	<b>15 LVF 13 Optima</b>	fpm	9	→	25	→	79	→	138	→	184	5	→	12	→	40	→	69	→	92	15	11	656 ft				
		USt	2.8		2.8		2.8		1.5		0.9	5.5		5.5		5.5		3.1		1.8							
	<b>25 LVF 13 Optima</b>	fpm	13	→	36	→	112	→	184	→	230	→	269	7	→	20	→	56	→	92	→	115	→	135	25	18	1079 ft
		USt	2.8		2.8		2.8		1.6		1.2		0.7	5.5		5.5		5.5		3.2		2.4		1.4			
	<b>15 LVF 15 Optima</b>	fpm	7.5	→	20	→	62	→	112	→	151						15	11	522 ft								
		USt	3.3		3.3		3.3		1.9		1																
	<b>25 LVF 15 Optima</b>	fpm	12	→	31	→	98	→	157	→	197	→	236						25	18	748 ft						
		USt	3.3		3.3		3.3		1.9		1.4		0.8														
	<b>RVF 61 Optima +</b>	rpm	0 → 0.8										7.5	5.5													
	<b>4 DVF 3</b>	fpm	0 → 207										5	3.7													
	ZC 2030 ZD 2030 <b>RT 224</b>	fpm	98										2 x 4.8	2 x 3.5													
	ZC 4230 <b>RT 324</b>	fpm	49 - 98										2 x 8.4	2 x 6.2													
		<b>CEI 38</b>						<b>kVA</b>																			
		480 V (+6% -10%) 60 Hz					15 LVF : 25 kVA 25 LVF : 35 kVA																				

15 LVF 13 Optima

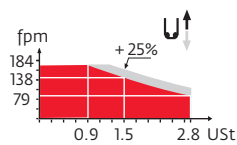

25 LVF 13 Optima

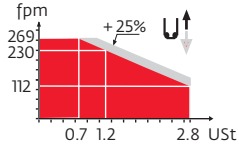



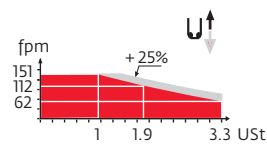

15 LVF 15 Optima

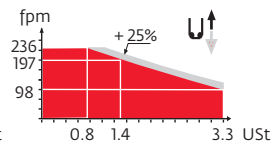







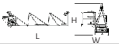
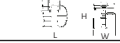
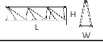
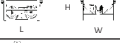
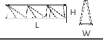
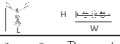
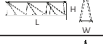
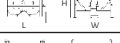
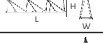

25 LVF 15 Optima

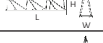
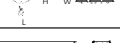
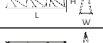
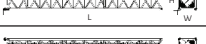
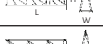
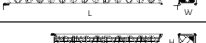
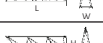
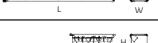
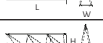

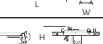
-  Hoisting
-  Trolleying
-  Slewing
-  Traveling
-  Consult us

# Component weights

Description	L x W x H (ft)	Weight (lb)	Description	L x W x H (ft)	Weight (lb)
Counter-jib assembly transport position 	39 x 5.3 x 8.1	9369	Jib foot (B3040) 	35.3 x 5.9 x 7.2	6217
Cab V140L and support 	8.8 x 7.9 x 9.6	1911	Jib section (H3046) 	33.5 x 2.6 x 6.4	2425
SM trolley 	3.7 x 3.3 x 2.4	362	Jib section (A3016) 	33.4 x 2.6 x 6.3	1636
SM hookblock 	2.4 x 0.7 x 3.7	293	Jib section (F3021) 	33.3 x 2.6 x 4.9	1248
2C trolley 	3.6 x 3.3 x 2.4	287	Jib section (X3060) 	16.8 x 2.6 x 4.8	419
2C trolley 	3.7 x 3.3 x 2.4	254	Jib section (H3127) 	16.7 x 2.6 x 3.3	381
2C hookblock 	3.6 x 0.7 x 4.5	511	Jib section (U3115) 	6.7 x 2.6 x 3.3	132
SR24E-2 	35.1 x 4.2 x 4.2	4850	Jib section (D3088) 	17 x 2.6 x 6.3	880
SR26E-2 	35.3 x 4.2 x 4.2	6338	Jib section (P3098) 	16.9 x 2.6 x 6.2	710
SR25F-2 	25.4 x 4.3 x 4.3	4403	Jib section (B3144) 	16.9 x 2.6 x 4.9	633
S24A1-2 	10.5 x 4.2 x 4.3	1572	Jib section (N3097) 	16.8 x 2.6 x 4.9	624
K40 / L20 	9.7 x 6.9 x 6.8	1219	Jib tip 	3.1 x 3.1 x 1.5	132
Cross shaped base ZD 4230 (4,5 m) 	21.7 x 2.6 x 3.6	4034	Counter-jib ballast CBQ (1000 kg) 	0.8 x 2.2 x 9	2205
	21.7 x 1.6 x 4.3	4707	Counter-jib ballast CBP (3000 kg)	2.3 x 2.2 x 9.2	6614

# Notes

Constant improvement and engineering progress make it necessary that we reserve the right to make specification, equipment and price changes without notice. Illustrations shown may include optional equipment and accessories, and may not include all standard equipment.



[www.manitowoc.com](http://www.manitowoc.com)

## Regional Headquarters

### Americas

Manitowoc, Wisconsin, USA  
Tel: +1 920 684 6621  
Fax: +1 920 683 6277

Shady Grove, Pennsylvania, USA  
Tel: +1 717 597 8121  
Fax: +1 717 597 4062

### Europe, Middle East, Africa

Ecully, France  
Tel: +33 472 18 2020  
Fax: +33 472 18 2000

### Asia - Pacific

Shanghai, China  
Tel: +86 21 6457 0066  
Fax: +86 21 6457 4955

Potain MCT 88  
Code 09-003-.5M-0610