

A4 FEM1.001

H = Height under hook
 Altezza sotto gancio
 Hauteur sous crochet
 Altura bajo el gancho
 Высота под крюком

TOWER CONFIGURATION - REACTIONS

CONFIGURAZIONE TORRE - REAZIONI / CONFIGURATION TOUR - RÉACTIONS / TORRE DE CONFIGURACIÓN - REACCIONES / КОНФИГУРАЦИЯ БАШНИ - РЕАКЦИИ

▣ 2,1 m L = 6,0 m - B

	H (m)	Z (t)	F1(kN)
8	5,9 m	62,5	90,00
7	5,9 m	56,6	83,54
6	5,9 m	50,7	83,54
5	5,9 m	44,8	77,08
4	5,9 m	38,9	70,62
3	5,9 m	33,0	70,62
+2	5,9 m	27,1	70,62

▣ 2,1 m L = 6,0 m - C

	H (m)	Z (t)	F1(kN)
8	5,9 m	61,6	90,00
7	5,9 m	55,7	83,54
6	5,9 m	49,8	83,54
5	5,9 m	43,9	77,08
4	5,9 m	38,0	70,62
3	5,9 m	32,1	70,62
+2	c	26,2	70,62

▣ 2,1 m - D

	H (m)	F2(kN)	F3(kN)
8	5,9 m	58,4	1717
7	5,9 m	52,5	1429
6	5,9 m	46,6	1238
5	5,9 m	40,7	1172
4	5,9 m	34,8	1110
3	5,9 m	28,9	1053
+2	5,9 m	23,0	862

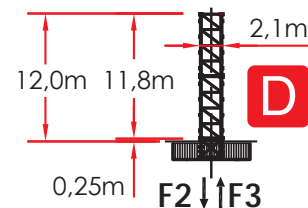
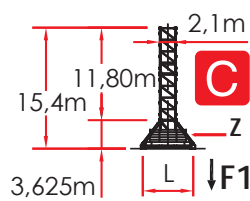
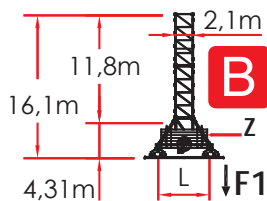

▣ 2,1 / 2,3 m

	H (m)	F2(kN)	F3(kN)
8	6,0 m	94,1	4538
7	6,0 m	88,1	4134
6	6,0 m	82,1	3546
5	6,0 m	76,1	2976
+4	6,0 m	70,1	2632

▣ 2,1m L - Booster

	H (m)	F2(kN)	F3(kN)
9	5,9 m	64,3	2309
8	5,9 m	-	-
7	5,9 m	-	-
6	5,9 m	-	-
5	5,9 m	-	-
4	5,9 m	-	-
3	5,9 m	-	-
+2	5,9 m	-	-

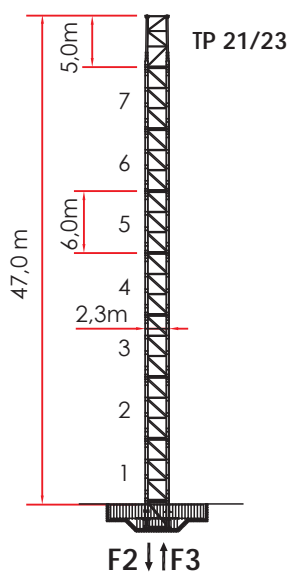

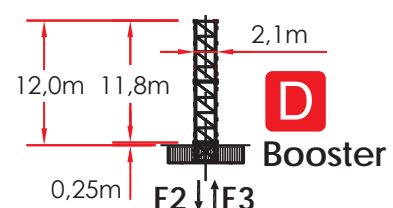

Comply with the specified ballast / Attenersi alla zavorra indicata / S'en tenir au lest indiqué / Respetar el peso de lastre indicado / Соблюдать указанный балласт



LOAD DIAGRAMS 12.0 T / 6.0 T

DIAGRAMMA DI PORTATA / DIAGRAMME DE CHARGE UTILE / CURVAS DE CARGA /
 ДИАГРАММА ГРУЗОПОДЪЕМНОСТИ

12.000 Kg / 6.000 Kg

JIB	36.0	40.0	46.0	50.0	56.0	60.0	66.0	70.0	75.0
2,8 ▶	24.0	30.0	25.9	25.8	25.6	25.3	24.7	24.2	18.0
15	12000	12000	12000	12000	12000	12000	12000	12000	12000
16	12000	12000	12000	12000	12000	12000	12000	12000	12000
18	12000	12000	12000	12000	12000	12000	12000	12000	11991
20	12000	12000	12000	12000	12000	12000	12000	12000	10605
22	12000	12000	12000	12000	12000	12000	12000	11720	9483
24	12000	12000	12000	12000	12000	11997	11782	10599	8557
26	12000	12000	12000	11692	11331	10943	10745	9657	7778
28	11755	11326	11050	10739	10405	10045	9862	8855	7115
30	10864	10464	10207	9917	9606	9272	9101	8163	6543
32	10087	9713	9472	9202	8911	8598	8438	7561	6045
34	9405	9054	8827	8573	8300	8005	7856	7031	5908
36	8800	8469	8256	8016	7758	7481	7340	6562	5520
38		7948	7746	7519	7275	7013	6879	6144	5175
40		7480	7288	7073	6842	6593	6466	5769	4864
42			6876	6671	6451	6214	6094	5730	4584
44			6501	6306	6096	5871	5756	5423	4330
46			6160	5974	5773	5557	5748	5143	4099
48				5996	5778	5571	5466	4887	3887
50				5690	5506	5308	5207	4652	3693
52					5256	5065	4968	4435	3514
54					5025	4841	4748	4235	3348
56 *					4810	4633	4544	4094	3195
58						4440	4353	3876	3052
60						4260	4176	3715	2919
62							4011	3565	2795
64							3856	3424	2678
66							3710	3292	2569
68								3167	2466
70								3050	2369
72									2278
74									2191
75		- 250 Kg							2150

* LOAD DIAGRAM FOR SPECIFIC EXERCISE TO ONE TROLLEY / DIAGRAMMA DI PORTATA PER ESERCIZIO SPECIFICO DI 1 CARRELLO

ULTRALIFT _ALL INTERMEDIATE LOADS ARE DECREASED OF 10% IF THE CRANE IS NOT EQUIPPED WITH ULTRALIFT CONTROL / SENZA IL SISTEMA ULTRALIFT TUTTE LE PORTATE INTERMEDIE DIMINUISCONO IL CARICO DEL 10% / LES CHARGES INTERMEDIARES SONT DIMINUÉES DE 10% SI LA GRUE N'EST PAS ÉQUIPÉ D'UN CONTROLE ULTRALIFT / SIN EL SISTEMA ULTRALIFT LOS MISAURA INTERMEDIOS DISMINUIR EL CARICO DEL 10% / БЕЗ ULTRALIFT ПРОМЕЖУТОЧНОЙ УМЕНЬШАЕТСЯ НА 10% НАГРУЗКИ.

LOAD DIAGRAMS 14.0 T / 7.0 T

DIAGRAMMA DI PORTATA / DIAGRAMME DE CHARGE UTILE / CURVAS DE CARGA /
 ДИАГРАММА ГРУЗОПОДЪЕМНОСТИ

14.000 Kg / 7.000 Kg

JIB	36.0	40.0	46.0	50.0	56.0	60.0	66.0	70.0	75.0
2,8 ▶	24.0	30.0	25.9	25.8	25.6	25.3	24.7	24.2	18.0
15	14000	14000	14000	14000	14000	14000	14000	14000	14000
16	14000	14000	14000	14000	14000	14000	14000	14000	13746
18		14000	14000	14000	14000	14000	14000	14000	11991
20	14000	14000	14000	14000	14000	14000	14000	13078	10605
22	14000	14000	14000	14000	13687	13223	12985	11720	9483
24	14000	13534	13156	12832	12395	11997	11782	10599	8557
26	12790	12358	12010	11692	11331	10943	10745	9657	7778
28	11755	11326	11050	10739	10405	10045	9862	8855	7115
30	10864	10464	10207	9917	9606	9272	9101	8163	6843
32	100087	9713	9472	9202	8911	8598	8438	7561	6345
34	9405	9054	8827	8573	8300	8005	7856	7031	5908
36	8800	8469	8256	8016	7758	7481	7340	6862	5520
38		7948	7746	7519	7275	7013	6879	6444	5175
40		7480	7288	7073	6842	6893	6766	6069	4864
42			6876	6971	6751	6514	6394	5730	4584
44			6801	6606	6396	5871	6056	5423	4330
46			6460	6274	6073	5557	5748	5143	4099
48				5996	5778	5571	5466	4887	3887
50	*			5690	5506	5308	5207	4652	3693
52					5256	5065	4968	4435	3514
54					5025	4841	4748	4235	3348
56					4810	4633	4544	4094	3195
58						4440	4353	3876	3052
60						4260	4176	3715	2919
62							4011	3565	2795
64							3856	3424	2678
66							3710	3292	2569
68								3167	2466
70								3050	2369
72									2278
74									2191
75									2150

* LOAD DIAGRAM FOR SPECIFIC EXERCISE TO ONE TROLLEY / DIAGRAMMA DI PORTATA PER ESERCIZIO SPECIFICO DI 1 CARRELLO

ULTRALIFT _ALL INTERMEDIATE LOADS ARE DECREASED OF 10% IF THE CRANE IS NOT EQUIPPED WITH ULTRALIFT CONTROL / SENZA IL SISTEMA ULTRALIFT TUTTE LE PORTATE INTERMEDIE DIMINUISCONO IL CARICO DEL 10% / LES CHARGES INTERMEDIARES SONT DIMINUEES DE 10% SI LA GRUE N'EST PAS EQUIPE D'UN CONTROLE ULTRALIFT / SIN EL SISTEMA ULTRALIFT LOS MISAURA INTERMEDIOS DISMINUIR EL CARICO DEL 10% / БЕЗ ULTRALIFT ПРОМЕЖУТОЧНОЙ УМЕНЬШАЕТСЯ НА 10% НАГРУЗКИ.

ER 240

HOISTING WINCH INVERTER - PERFORMANCES

MECCANISMI / MÉCANISMES / MECANISMOS / МЕХАНИЗМЫ

400 VOLT ± 5% - 50Hz _DIRECTIVE 14/12 - 2005/88/CE

HOISTING WINCH	POWER POTENZA		ROPE FUNE	STEP MARCIA	LOAD CARICO	SPEED VELOCITÀ	LOAD CARICO	SPEED VELOCITÀ
ARGANO	CV-ch Ps-hp	kW	m.		Kg.	m/min.	Kg.	m/min.
12,0 T rope Ø 16 mm	75	55	300 500 LB	1	6000	8	12000	4
				2	6000	24	12000	12
				3	6000	40	12000	20
				4	3600	64	7200	32
				5	2500	80	5000	40
				5	0 – 1000 (*)	104 (*)	0 – 2000 (*)	52 (*)
14,0 T rope Ø 16 mm	75	55	300 500 LB	1	7000	8	14000	4
				2	7000	24	14000	12
				3	7000	40	14000	20
				4	3600	64	7200	32
				5	2500	80	5000	40
				5	0 – 1000 (*)	104 (*)	0 – 2000 (*)	52 (*)
16,0 T rope Ø 16 mm	75	55	300 500 LB	1	8000	6	16000	3
				2	8000	20	16000	10
				3	8000	34	16000	17
				4	4000	52	8000	26
				5	2500	70	5000	35
				5	0 – 1200 (*)	84 (*)	0 – 2400 (*)	42 (*)

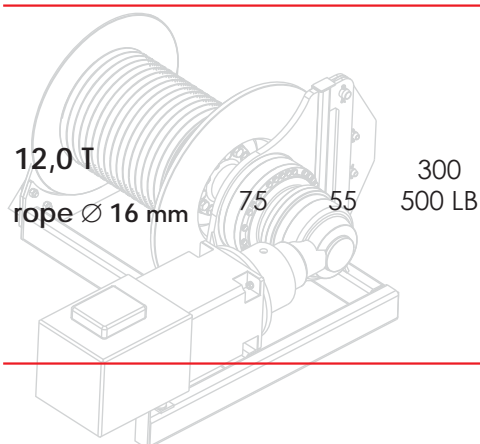

HOISTING WINCH INVERTER - PERFORMANCES

MECCANISMI / MÉCANISMES / MECANISMOS / МЕХАНИЗМЫ

400 VOLT ± 5% - 50Hz _DIRECTIVE 14/12 - 2005/88/CE

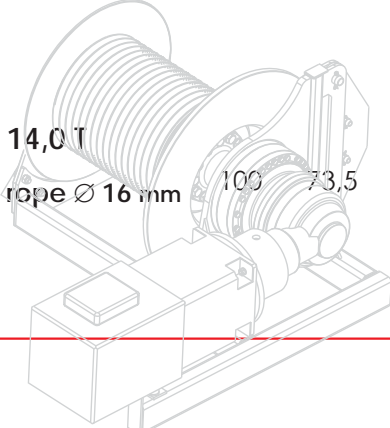
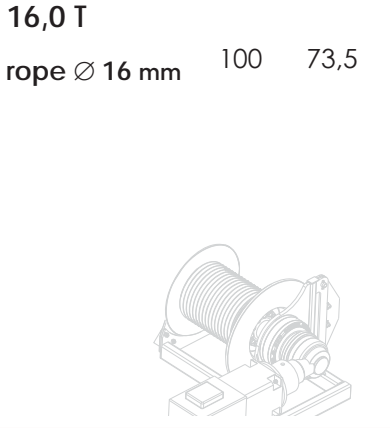
HOISTING WINCH	POWER POTENZA	ROPE FUNE	STEP MARCIA	LOAD CARICO	SPEED VELOCITÀ	LOAD CARICO	SPEED VELOCITÀ
ARGANO	CV-ch Ps-hp	kw	m.	Kg.	m/min.	Kg.	m/min.
 <p>14,0 T rope Ø 16 mm</p>	100	73,5	700 LB	1	8	14000	4
				2	30	14000	15
				3	52	14000	26
				4	92	7500	46
				5	136	5000	68
 <p>16,0 T rope Ø 16 mm</p>	100	73,5	700 LB	1	8	16000	4
				2	30	16000	15
				3	52	16000	26
				4	92	8000	46
				5	136	5000	68
				45 kW	55 kW	73,5 kW	
ABSORPTIONS / ASSORBIMENTI				54 kW	62 kW	77 kW	



SLEWING

 0,26 / 0,48 / 0,7 min⁻¹

4 X 4 kW

(*) SPEED AUTOMATICALLY CONTROLLED BY A CURRENT SENSOR / VELOCITÀ REGOLATA AUTOMATICAMENTE DA SENSORE DI CORRENTE / VITESSE RÉGLÉE AUTOMATIQUEMENT PAR CAPTEUR DE COURANT / ACELERAR CONTROLADO AUTOMÁTICAMENTE POR UN SENSOR DE CORRIENTE / СКОРОСТЬ АВТОМАТИЧЕСКИ РЕГУЛИРУЕТСЯ ДАТЧИКОМ ТОКА



TROLLEY

13,0 / 35,0 / 56,0 m/min

6,6 kW

















TRAVELLING

19 m/min

4 X 4 kW

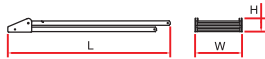

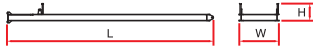





PACKING LIST

LISTA DEI COLLI / LISTE DE COLISAGE / LISTA DE CONTENIDO / ВЕС И ГАБАРИТНЫЕ РАЗМЕРЫ

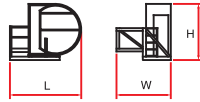
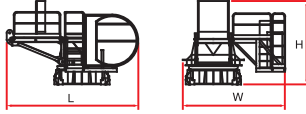
DESCRIPTION DENOMINAZIONE	ITEM POS.	PIECES PEZZI	DRAWING DISEGNO	DIMENSIONS mm			WEIGHT kg	
				L	W	H	UNIT	TOTAL
JIB ELEMENT / ELEMENTO DI FRECCIA / ELÈMENT DE FLÈCHE / ELEMENTO DE FLECHA / элемент стрелка		1 n. 1		6,200	1,500	1,670	941	-
		2 n. 2 - 5		6,240	1,500	1,670	895	1790
		1 n. 3		4,240	1,500	1,670	602	-
		1 n. 4		6,240	1,500	1,670	1000	-
	1	4 n. 6 - 7 7A - 8		6,240	1500	1,650	745	-
		1 n. 9		6,240	1,500	1,650	813	-
		2 n. 10 - 11		6,240	1,500	1,630	560	-
		1 n. 12		4,200	1,500	1,610	328	-
		1 n. 13		2,210	1,500	1,610	178	-
	JIB POINT / PUNTALE FRECCIA / ELÈMENT POINTE / PUNTALE DE FLECHA / наконечник стрелка		1		0,740	1,510	0,340	78
A FRAME / CUSPIDE / POINTE / CÚSPIDE / ШПИЛЬ	2	1		9,500	1,550	0,800	3500	-
EXTERNAL COUNTERJIB SECTION WITH HOISTING WINCH, ELECTRICAL BOX. TERMINAL ELEMENT* / ELEMENTO ESTERNO CONTROFRECCIA, ARGANO SOLL., QUADRO ELETR., PORTABLOCCHI* / CONTRFLÈCHE EXTÉRIURE PORTE TREUIL DE LEVAGE, ARMOIRE ELECTRIQUE, ELÈMENT TERMINAL* / CONTRAFLECHA, CABRESTANTE DE ELEVACIÓN, CUADRO ELÉCTRICO / контрстрела лебедка, электрические, блокодержатель*	3	1		7,100	2,270	2,040	3600	-
INTERNAL COUNTERJIB SECTION / ELEMENTO INTERNO CONTROFRECCIA / CONTRFLÈCHE INTÉRIEUR / ELEMENTO INTERNO DE LA CONTRAFLECHA / внутренний элемент контрстрелы	4	1		11,830	2,270	1,100	2100	-
COMPLETE COUNTERJIB / CONTROFRECCIA COMPLETA / CONTRFLÈCHE COMPLÈTE / CONTRAFLECHA COMPLETA / полная контрстрела	5	1		18,830	2,270	2,040	7000	-



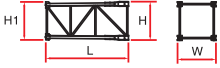
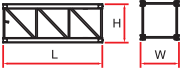

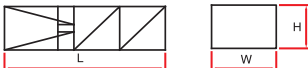

PACKING LIST

LISTA DEI COLLI / LISTE DE COLISAGE / LISTA DE CONTENIDO / ВЕС И ГАБАРИТНЫЕ РАЗМЕРЫ

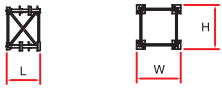
DESCRIPTION DENOMINAZIONE	ITEM POS.	PIECES PEZZI	DRAWING DISEGNO	DIMENSIONS mm			WEIGHT Kg			
				L	W	H	UNIT	TOTAL		
SWITCHBOARD SUPPORT FRAME / CODA TELAIO GIREVOLE / SUPPORT DE L'ARMOIRE ÉLECTRIQUE / COLA BASTIDOR GIRATORIA / поворотный хвост станины	6	1		2,470	1,700	2,530	1300	-		
SLEWING TABLE / GRUPPO GIREVOLE / TABLE TOURNANTE / GIRATORIO / вращения	7	1		2,300	2,540	2,270	5500	-		
ACCESS BALCONY, CABIN / BALLATOIO CABINA, CABINA / PORTE CABINE / BALCÓN CORRIDO CABINA, CABINA / площадка кабины, кабина	8	1		3,450	2,000	2,240	930	-		
ASSEMBLY OF POS. 6 - 7 - 8 / ASSIEME MONTATO N. 6 - 7 - 8 / GROUPE 6 - 7 - 8 / CONJUNTO MONTADO 6 - 7 - 8 / смонтированный сборочный узел 6 - 7 - 8	9	1		5,890	4,240	3,350	8180	-		
COUNTERWEIGHT BLOCK / BLOCCHI DI CONTRAPPESO / CONTRE-POIDS / BLOQUES DE CONTRAPESO / блоки противовеса	10	10		A	W	2,870	1,200	0,275	2022	20220
		1		B	W	1,815	1,200	0,275	1296	-
TOWER ELEMENT / ELEMENTO DI TORRE ÉLÉMENT DE MATURE / ELEMENTO DE TORRE / башенный элемент	11	-		GR5	5,90	2,300	2,300	3450	-	
	12	-			2,95	2,300	2,300	1900	-	
	13	-		GR6	5,000	2,325	H 2,320 H1 2,300	3000	-	
	14	-			6,000	2,325	2,320	5555	-	
BASE ELEMENT / ELEMENTO DI BASE / MAT DE BASE / ELEMENTO DE BASE / элемент основания	15	1		3,000	2,400	2,400	1950	-		
CLIMBING CAGE / GABBIA DI MONTAGGIO / CAGE DE MONTAGE / JAULA DE MONTAJE / монтажная клеть	16	1		8,530	3,100	2,300	7670	-		

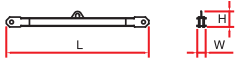
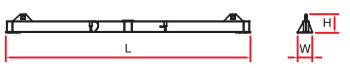
PACKING LIST

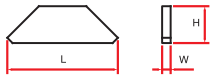
LISTA DEI COLLI / LISTE DE COLISAGE / LISTA DE CONTENIDO / ВЕС И ГАБАРИТНЫЕ РАЗМЕРЫ

DESCRIPTION DENOMINAZIONE	ITEM POS.	PIECES PEZZI	DRAWING DISEGNO	DIMENSIONS mm			WEIGHT Kg	
				L	W	H	UNIT	TOTAL
EXPENDABLE FOUNDATION ELEMENT / TRONCHETTO DI FONDAZIONE / ELÈMENT A SCELLER / TRONCO DE FUNDACIÓN / СТВОЛ ОСНОВАНИЯ	17	1		1,820	2,400	2,400	1370	-
FIXING ANGLES / GAMBE DI FONDAZIONE / PIEDS DE SCELLEMENT / PATAS DE FUNDACIÓN / НОЖКИ ОСНОВАНИЯ	18	4		1,820	0,470	0,470	280	1120
OBLIQUAL LEGS / PUNTONI DI BASE / JAMBES DE FORCE / CABRIOS DE BASE / СТОЙКИ ОСНОВАНИЯ	19	4		3,770	0,230	0,260	340	1360
BASE MAIN BEAM / TRAVE PRINCIPALE CROCIERA DI BASE / POUTRE DE CHASSIS DE BASE / VIGA PRINCIPAL DE LA CRUCETA DE BASE / главная балка крестовины основания	20	1		8,900	0,720	0,760	1650	-
HALF BASE BEAM / SEMITRAVE DI BASE / SEMIPOUTRE DE CHASSIS DE BASE / MEDIA VIGA DE LA CRUCETA DE BASE / полубалка крестовины основания	21	2		4,350	0,600	0,760	750	1500
DRIVEN BOGIE / BILANCINO TRASLAZIONE MOTORIZZATO / BOGGIE MOTORISÉE / BALANCÍN DE TRASLACIÓN MOTORIZADO / приводной балансир горизонтального перемещения	22	4		1,750	0,705	0,790	1000	4000
BASE BALLAST BLOCK / BLOCCO DI ZAVORRA / LEST DE BASE / BLOQUE DE LASTRE / блок балласта	23	-		4,200	0,320	1,400	3230	-
		-		5,200	0,400	1,400	6240	-

INTERNAL CLIMBING

GRU IN CAVEDIO / TÉLESCOPAGE SUR DALLES / GRUA EN CAVEDIO / ПОДНИМАЮЩИЙСЯ НА ПЛИТАХ ПЕРЕКРЫТИЯ

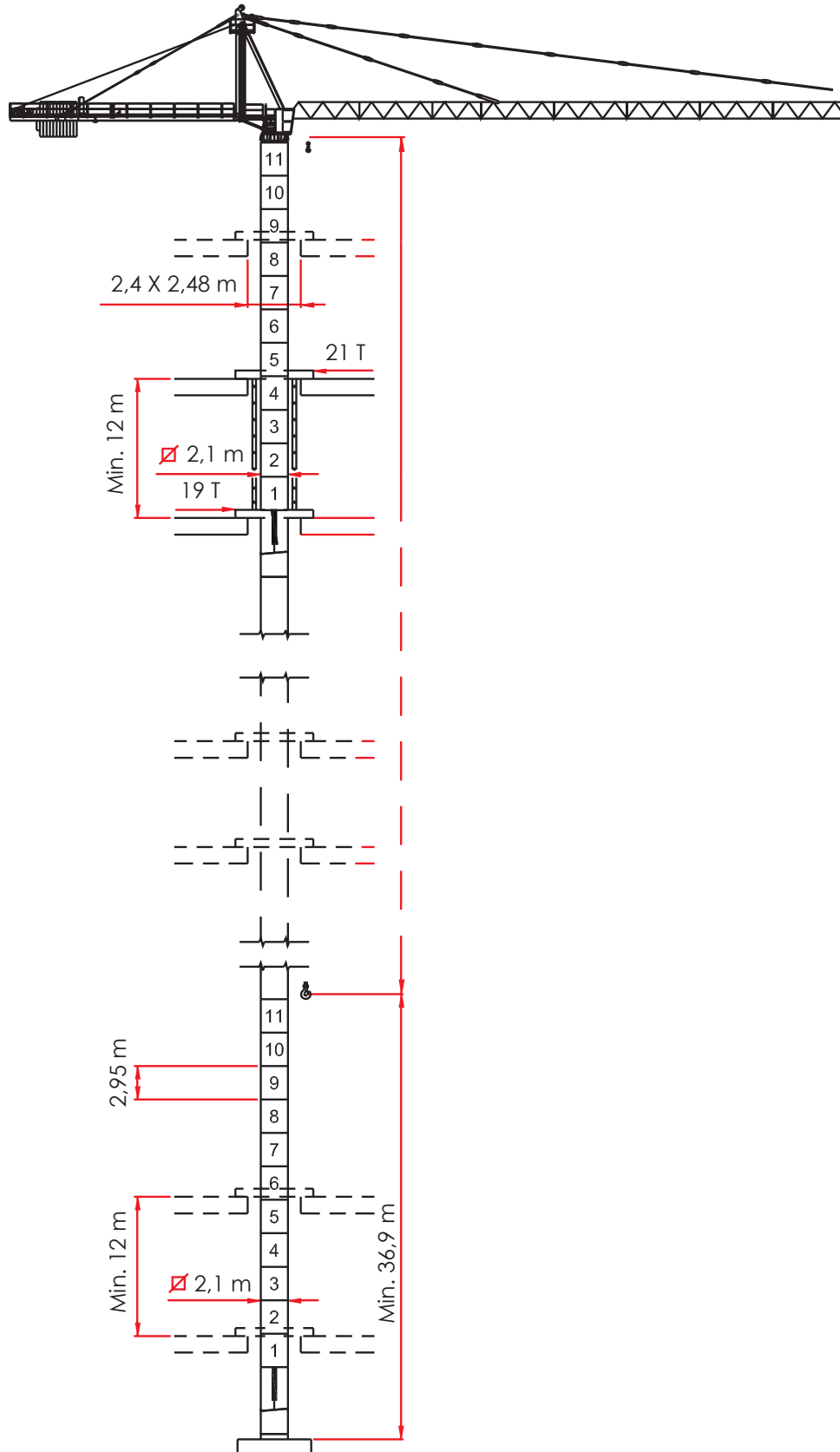

ER 240

EXTERNAL CLIMBING

SOPRALZO IDRAULICO / TELESCOPABLE / ELEVACIÓN HIDRÁULICA / ГИДРАВЛИЧЕСКОЕ НАРАЩИВАНИЕ

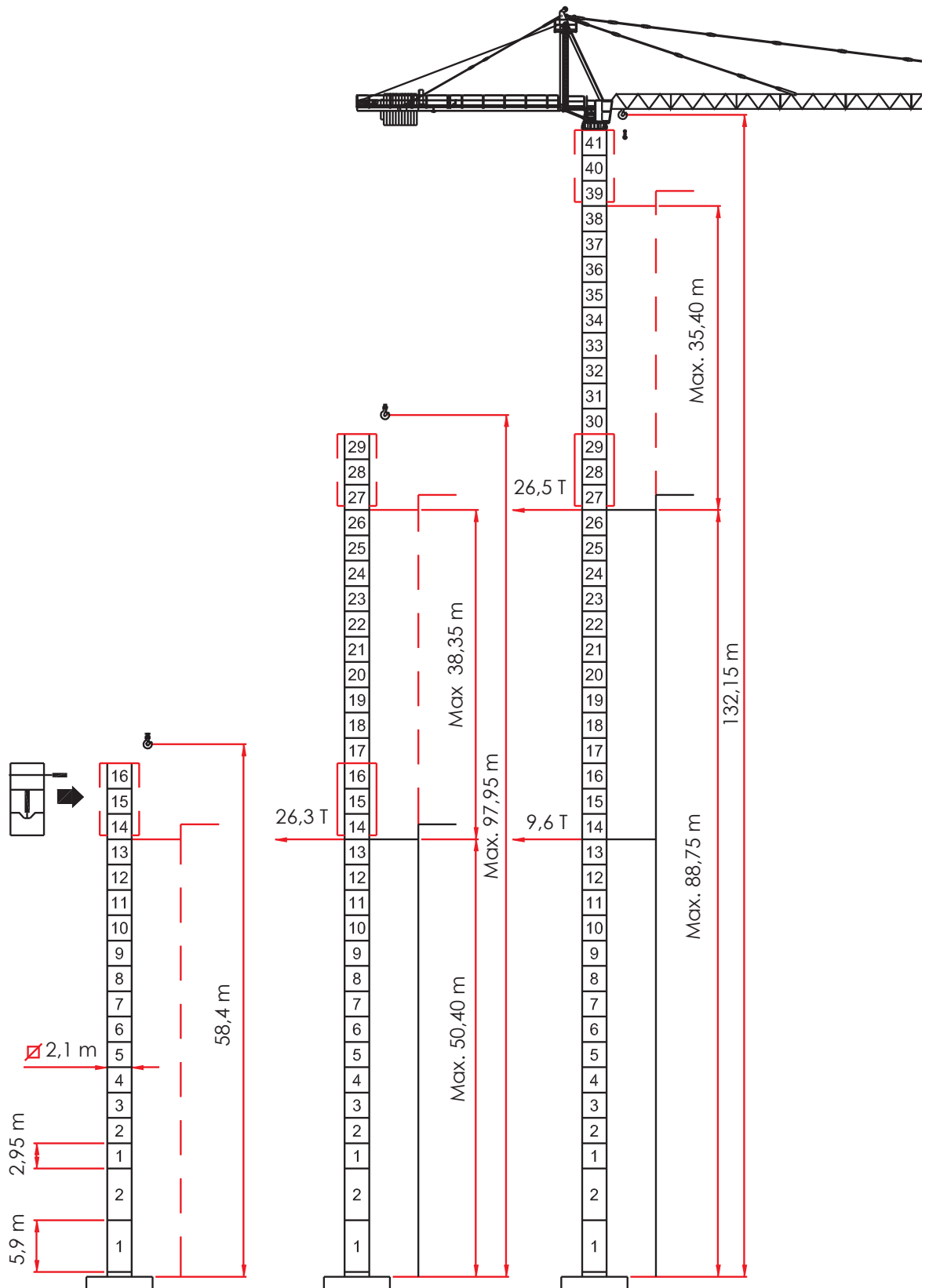

[ER 240 _REV. _0312] ADL / TECHNICAL DEPARTEMENT

THE DATA OBJECT OF THESE SHEETS ARE SUBJECT TO CHANGE WITHOUT PRIOR NOTICE / I DATI OGGETTO DELLE PRESENTI SCHEDE POTREBBERO SUBIRE MODIFICHE SENZA PREAVVISO / LES INFORMATIONS DONNÉES DANS LES PRÉSENTES FICHES POURRAIENT SUBIR DES MODIFICATIONS SANS PRÉAVIS / LOS DATOS CONTENIDOS EN ESTE FORMULARIO ESTÁN SUJETAS A CAMBIOS SIN PREVIO AVISO / ДАННЫЕ, УКАЗАННЫЕ В НАСТОЯЩИХ СПЕЦИФИКАЦИЯХ, МОГУТ ИЗМЕНЯТЬСЯ БЕЗ ПРЕДВАРИТЕЛЬНОГО ПРЕДУПРЕЖДЕНИЯ.