

ROTO



MERLO

BUILDING WITH CONFIDENCE.

ROTO



AN UNSTOPPABLE FORCE

Merlo technicians and engineers have always been fascinated by research and technological innovation.

They spur on our development and respond to daily challenges, whereby apparently insurmountable obstacles are overcome.

The strength of Merlo technology lies in its capacity to manufacture cutting-edge machines that change the way people work. Increased safety, comfort, and performance are the objectives that every design aims at achieving.

This is why each new Merlo machine sets new records in terms of design, power, and respect for both mankind and the environment.

Each new type becomes part of a winning team of inexhaustible power, and can overcome even the most challenging obstacles.

THE ROTO CONCEPT

ALL OVER THE WORLD



A NEW CONCEPT OF PRODUCTIVITY AND SAFETY

When traditional handling methods cannot get the job done, it's time for a new idea: Roto – a telescopic handler with the added dimension of a slewing turret.

Safety, efficiency and manoeuvrability are the key features of this revolutionary concept, the fruit of Merlo's research and experience since 1990.

Roto telehandlers embody a new concept of strength in action, successful even in the most challenging handling and lifting operations, thanks to their tremendous off-highway performance.

Imagine a family of machines, combining all the benefits of a telescopic handler plus a lightweight lifting capability and the ability to safely place personnel into position at height. On top of this, unrivalled mobility on the road and brilliant performance on site. With load capacities up to 5 tons and lift heights of over 31 metres (MCTJ model). Put simply, that is the Roto! Three distinct product families offer high profitability and versatility in site tasks that would normally require several specialised or larger machines.



ROTO 600 SERIES
 More conventional machines, which offer uncompromised performance and safety and a turret rotation of up to 600 degrees ($\pm 300^\circ$) together with a unique automatic stabilising and levelling system.

ROTO 400 SERIES
 High-speed, compact and manoeuvrable machines with a turret rotation of 415 degrees ($\pm 208^\circ$).



ROTO MCSS SERIES
 The best of cutting-edge technology and with the versatility of vertical outriggers. The benefits of automatic digital stability control and continuous turret rotation.

THE ROTO RANGE

5000 kg	▶ ROTO 50.10												▶ ROTO 50.16 MCSS																	
4900 kg																														
4800 kg																														
4700 kg																														
4600 kg																														
4500 kg																			ROTO 45.19 MCSS		ROTO 45.19		▶ ROTO 45.21 MCSS / ROTO 45.21 MCTJ		ROTO 45.21					
4400 kg																														
4300 kg																														
4200 kg																														
4100 kg																														
4000 kg																									▶ ROTO 40.25 MCSS		▶ ROTO 40.26 MCSS			
3900 kg																														
3800 kg													▶ ROTO 38.14 / ROTO 38.14 S																	
3700 kg													▶ ROTO 38.16 / ROTO 38.16 S																	
3600 kg																														
3500 kg																														
	10m	11 m	12 m	13 m	14 m	15 m	16 m	17 m	18 m	19 m	20 m	21 m	22 m	23 m	24 m	25 m	26 m	27 m	28 m	29 m	30 m									

- ▶ ROTO MCSS SERIES
- ▶ ROTO 600 SERIES
- ▶ ROTO 400 SERIES

WINNING INNOVATION

SAFETY, COMFORT, PERFORMANCE



AN INTEGRATED SYSTEM FOR HANDLING AND LIFTING

The heart of the Roto is a robust self-propelled carrier base – equipped with stabilisers to ensure superb stability when lifting – on which the slewing turret is mounted, along with the driver's cab and telescopic boom.

These are highly mobile machines. The strength of the chassis, Merlo-designed and built drive/steer axles, extraordinary ground clearance with generous approach and departure angles and road travel at up to 40 kph, all add up to unrivalled driving dynamics. Rotos are built to move easily and safely on uneven terrains, in the mud and in the snow, even fording streams. A low centre of gravity assures safe travel performance on all surfaces.

When you demand the most from Roto telehandlers, day by day you will find them among the safest and most comfortable of working systems, giving their best in reliability, quality, profitability and, most of all, safety!

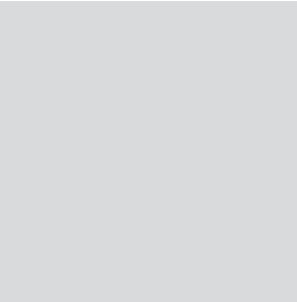

Many Roto models feature **hydropneumatic suspension** which permits travel at up to 40 kph, whilst ensuring maximum driving comfort. It also maximises stability when operating on tyres, by levelling the machine.

The standard **hydraulic quick-attach fork carriage allows attachments** to be quickly interchanged using controls in the cab. A **double-acting hydraulic service fitted with quick couplings** provides the power for hydraulically-operated equipment.

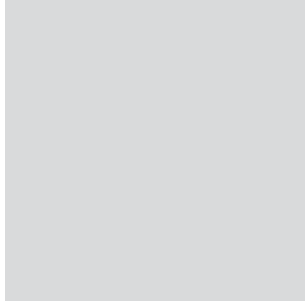

Four hydraulic, independently controlled stabilisers ensure a level, stable base for safe lifting.

The **telescopic boom extension mechanism** is housed entirely within the boom assembly, protecting it from site damage and ensuring maximum productivity.

The **continuous turret rotation** of MCSS models is achieved through a revolutionary and exclusive electro-hydraulic central rotary coupling.

The **axles** are designed and manufactured by Merlo, exclusively for telescopic handler application.

The cab offers superb visibility all around and, on some models, **can be tilted by up to 18 degrees** to offer an unequalled loading view at maximum height.

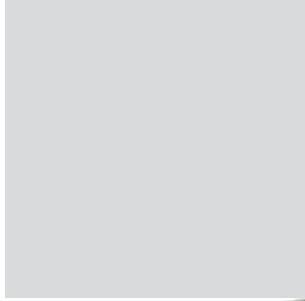

The **headlights are installed on the slewing turret**, ensuring optimum illumination of the work area, irrespective of turret rotation.

The load-bearing structures of the machine are surrounded by a **solid ring of steel**, serving both structural and protective functions.



THE CAB

MORE SPACE FOR ERGONOMICS AND DESIGN



WORKING HAS NEVER BEFORE BEEN SUCH A PLEASURE

The cab is engineered to ensure comfort and driving safety.

Modern and sleek of design, it features the widest interior space in its sector. The steel frame complies with the international ISO 3449 FOPS (Falling Object Protective Structure) standard.

The cab is fixed upon special elastic mounts, designed to reduce vibration and increase the driver's productivity.

For the same reasons, mechanical and hydraulic control assemblies are placed directly on the chassis, with all main services controlled electrically.

An exceptionally deep windscreen and very wide rear window – both openable – ensure excellent visibility of the working area. Excellent upwards visibility is provided by the wide shock-resistant roof glazing and top models even feature a tilting cab module for the ultimate load visibility at height!



◀ Roto MCSS models are equipped with an **electronic multi-functional** joystick, placed on the adjustable armrest (photo left). Optionally, a second joystick can also be installed on the left armrest. Roto 600 and 400 series are equipped with a simpler **electro-mechanical proportional** joystick (photo above).



▶ A **stability indicator 'traffic light'** is conspicuously fitted at the driver's eye height. On Roto 400 series machines it also indicates boom tilt angle.



▶▶ A column-mounted **Finger-Touch electrical control lever** allows the driver to reverse driving direction without taking his hands off the steering wheel. The **high/low travel speed range selector** is electrically controlled via push-buttons on the Roto MCSS (photo right) or a rocker switch on Roto 600 and 400 series models (photo above).

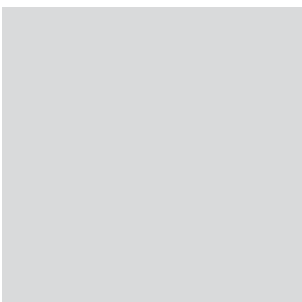



The new **Merlo seat** can be moved through a wide adjustment range and both seat cushion and back are equipped with supports for maximum comfort. Certain models have a **pneumatic suspension seat** fitted as standard.



The cab **can be hydraulically tilted** through up to 18 degrees on Roto 40.26 and 40.25 MCSS models – providing excellent loading visibility at full height without neck strain for the driver.



The cab is **easy to access** thanks to self-cleaning steps and a flat, obstacle-free floor. Both upper and lower sections of the cab door open through a full 180°.



Roto MCSS models are equipped with **digital** instruments and indicators. Both the 600 and 400 series have **analogue instrument panels**.

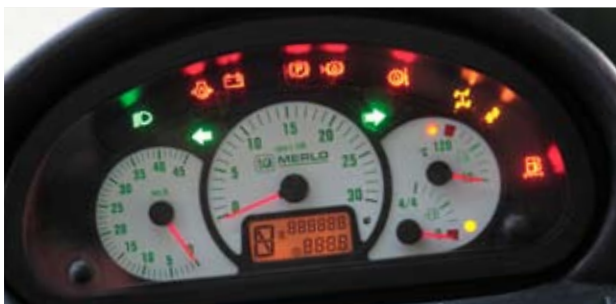



◀ The **steering wheel tilt** can be adjusted by up to 16 degrees, to match diverse driver shapes and sizes.



▶ An optional two-position **sun screen** ensures comfort, even in bright sunlight.



◀ The **rotating beacon** folds **down** to reduce overall height.



▶ **Controls for both stabilisers and the hydropneumatic suspension** are clustered on the side console.



▶ **Storage compartments** of varying capacities are fitted throughout the cab module.

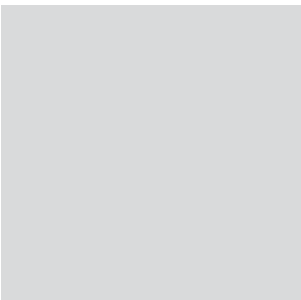

THE MERLIN SYSTEM

CONTROL AT YOUR FINGERTIPS



TECHNOLOGY A GENERATION AHEAD!

The Merlin system (Merlo Local Interactive Network) is used on all models of the MCSS range. It provides a completely new way to electronically manage all the operating parameters of the machine.

The core of the system is a computer, which acquires and processes in real time all inputs and outputs from the various working areas of the machine. The main operating conditions and all information necessary to the operator are continuously displayed in an easy and intuitive format.

The Merlin system also manages all safety functions, and acts as a versatile and effective tool for advanced and remote diagnostics.

Optionally, it can also serve as an antitheft system and immobiliser, providing a much higher degree of security against unauthorised use.

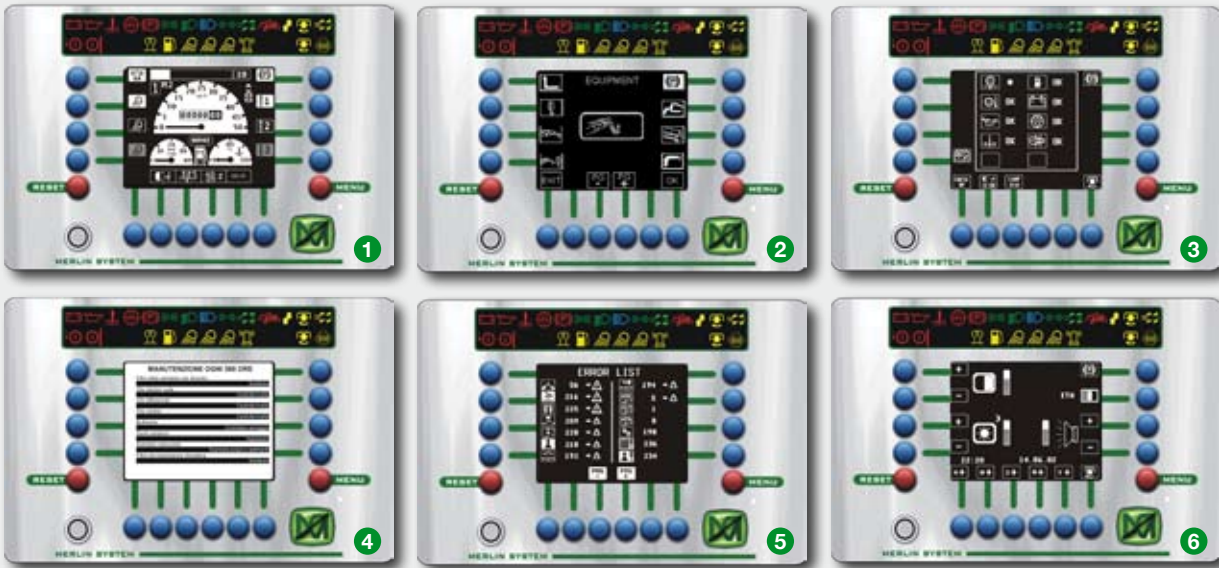

The management software allows the operator to select a variety of interactive menus, providing access to the various levels of the system.

1 - Main menu

Constantly shows the main operating parameters of the machine, and allows the operator to set the desired cab temperature and to control auxiliary systems.

2 - Attachment menu

It allows the operator to pre-select the main types of interchangeable equipment.

3 - General control menu

Provides a system diagnosis, after which the status of all devices/systems checked is displayed.

4 - Service menu

In reality, a 'black box' that records the information

coming from the different systems, and reminds the operator of service intervals.

5 - Check-up menu

A simple button press reveals real-time status information of all devices.

6 - Screen adjustment menu

It allows the operator to set the screen parameters, to suit ambient lighting conditions.

OPERATING MENU. DISPLAY OF THE CENTRE OF GRAVITY

An exclusive feature of the Merlin system is the real-time display (both in numerical and graphical form) of the centre of gravity position of the machine and load, and how it moves during machine operation.

The system also monitors the distance between the load and ground, distance between load and machine centreline, and the weight of the load being handled. The operator can predefine the working area of the machine by presetting the limits for turret rotation, boom lift angle and extension.

When displaying the position of the overall centre of gravity, the machine stability limits are determined, depending on the position and extension of the stabilisers and where the load is positioned. In this way, the operator can see when the machine approaches its operating limits and can maximise machine performance.

The accuracy of the system is unaffected by the attachment installed on the fork carriage (eg forks, winches, fly-jibs, hooks, and personnel baskets).

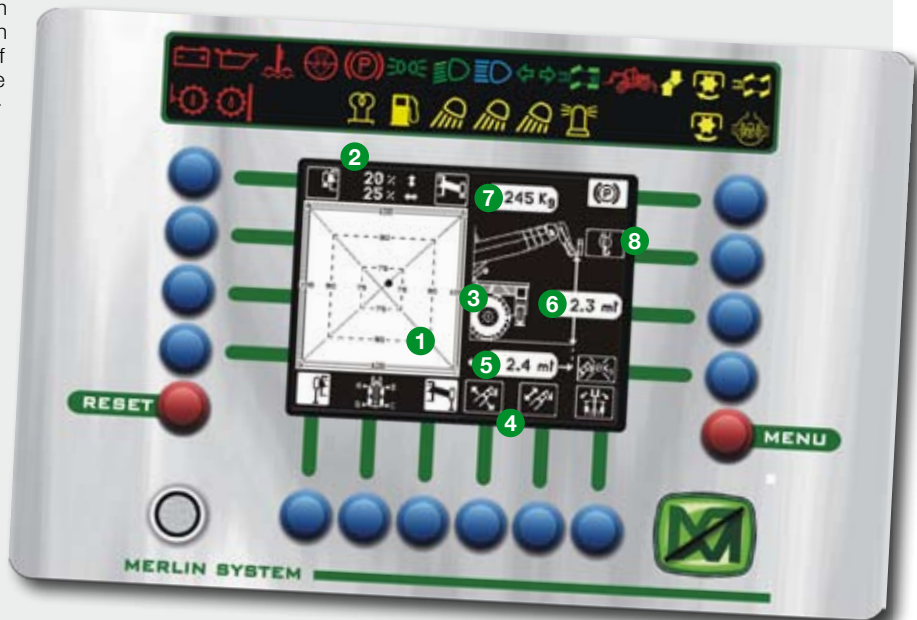

1 - Position of the centre of gravity relative to the working area; 2 - Longitudinal and transversal stability indicator; 3 - Stability status of the machine; 4 - Limitation of working area; 5 - Distance between the load and the turret centreline; 6 - Distance between the load and the ground; 7 - Weight of the load being handled; 8 - Equipment type in use.

THE SLEWING TURRET

WORKING THROUGH 360°



VERSATILITY WITHOUT LIMIT

The maximum turret rotation of Roto telehandlers varies depending on the model. On Roto models of the MCSS series the turret rotates continuously, while rotation is restricted to 600 degrees ($\pm 300^\circ$) on the 600 series, and to 415 degrees ($\pm 208^\circ$) on the 400 series.

Continuous rotation enhances machine performance and speeds up handling operations, because there is no need for the turret to go back to its starting point. Continuous rotation is achieved through the use of a revolutionary Merlo electro-hydraulic central rotary coupling.

All signals and commands required for turret rotation are transmitted through a single electronic channel, which is not sensitive to the angular position of transmitter and receiver, eliminating electrical connections and all the limitations of conventional sliding-contacts. This innovative system is reliable, air and watertight and very compact.

Two microprocessors, one on the turret and the other on the chassis, convert electrical signals into codified impulses, and vice versa.

▶ The operator has also **excellent rear visibility**, which is vital both during turret slewing and while manoeuvring on site.



◀ Any services being used in a personnel platform can be supplied from an **electrical outlet** (with isolator switch) or a **quick-coupling air or water hose**, which can be specified as options on the turret.

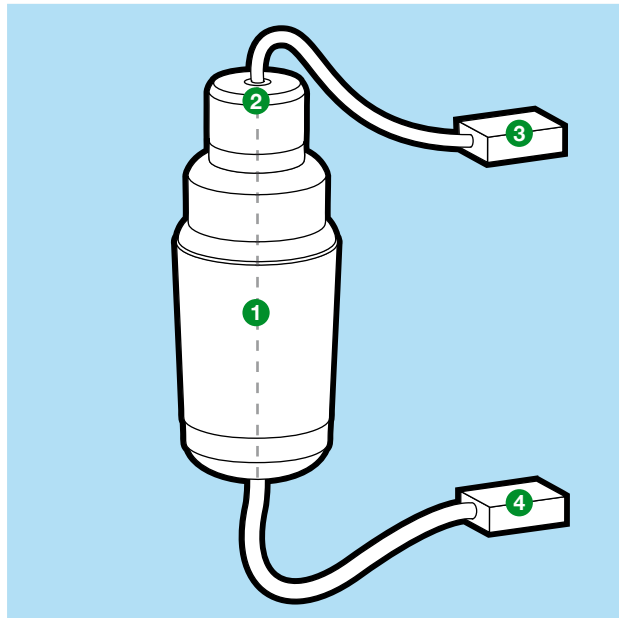

▶ The **central rotary electro-hydraulic joint** includes a separate stainless steel section, which circulates hot water generated by the diesel engine to heat the cab. There is, therefore, no need to install an auxiliary cab heating system.

1 - Rotary hydraulic joint; 2 - Codified transmission line; 3 - Micro-processor and link to the controls in the cab; 4- Microprocessor and link to the power controls in the undercarriage.



◀ Among several options that enhance the productivity and the versatility of telehandlers, is a boom mounted **video camera with cab monitor**.

THE TELESCOPIC BOOM

BRILLIANT SIMPLICITY



NOW EVERYTHING IS CLOSER AT HAND

The telescopic boom is the core of every telehandler. It must be robust and strong - so as to ensure a good load capacity and to be safely extended. But also very rigid, even at its maximum extension, so as to prevent undue flexing and the 'banana boom' effect. Merlo engineers have successfully created a telescopic boom assembly that has become a benchmark in the industry.

The boom sections are made of two U-shaped high-strength steel plates, longitudinally welded to each other along or close to their neutral axis. A hydraulically powered extension mechanism is fully enclosed within the boom sections and protected from site damage. The boom sections slide on special adjustable anti-friction pads, made of new-generation polymers, and exclusively used by Merlo.

The versatility of Roto telehandlers can be further increased by an almost endless list of attachments and optional equipment, which can be interchanged on the fork carriage in only a few moments. The variety of applications is vast: lifting materials, placing personnel safely, bridge and viaduct maintenance, boat handling, tunnel ring placing, and cladding of both civil and industrial build-

ings being just a few examples. It takes but a few moments to connect an attachment to the fork carriage (Fig. 1). **The hitching and locking operations are controlled directly from the cab**, while hydraulic quick-couplings make connection of the hydraulic supply simple and allows the machine to be immediately operational. Equipping the fork carriage with the hydraulic locking **Tac-Lock**

system (Fig. 2), gives Roto telehandlers an extraordinary competitive advantage against conventional, manual hook-up systems. A **connection box** is mounted on the jib head for the selection of a variety of electrically controlled equipment. A **standard double-acting hydraulic service with quick couplings** is fitted on the boom for the powering of hydraulic attachments (Fig. 3).

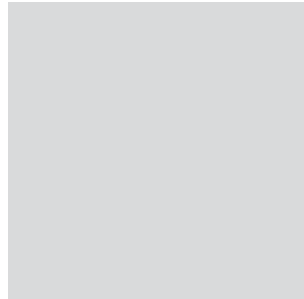
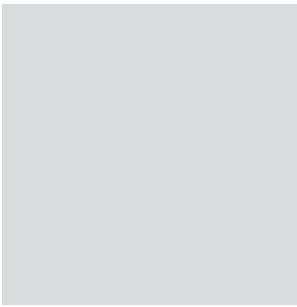
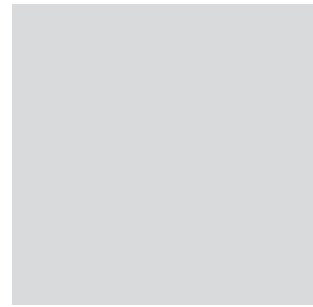

◀ The **boom extension mechanism**, together with its hydraulic and electrical components, is fitted completely within the boom sections, ensuring maximum protection and reliability.

MERLO RADIO CONTROL SYSTEM

A digital multifunctional radio control allows the operator to **remotely and accurately control the machine**, thus ensuring safety in even the most challenging situations. This recently introduced innovative Merlo technology is certified by the main European bodies and allows all machine functions to be proportionally controlled. The radio transmission system uses the latest **Frequency Hopping** concept, ensuring high immunity to interference, delivering maximum transmission safety. The Merlo radio control is **bi-directional**: it both **sends commands** to the machine and **receives information** on its operating status (eg. engine running or not, fuel level, stability condition, overload, etc.), thus performing a real-time remote diagnostic ability.



STABILISERS

STABILITY MEANS ALWAYS KEEPING ONE'S FEET ON THE GROUND!



STABILITY IS STANDARD

Four hydraulically operated stabilisers ensure that Roto telehandlers are stable on any terrain.

The operator can configure the stabilisers to suit the type of terrain and the slope, so as to always work in maximum safety. Uniquely, MCSS models can be operated safely with their stabilisers only partially extended, permitting working close to kerbs or walls, or in very narrow streets. Irrespective of the stabiliser footprint, the operating envelope resulting from the stability polygon they create ensures maximum operating safety.

All Roto models can be easily levelled by operating the stabilisers in pairs. Lateral and longitudinal tilt can be separately adjusted.

On some models, the four stabilisers can be automatically and simultaneously retracted to their fully stowed position with a single button press. When retracted, the stabilisers are contained within the machine periphery.



◀ **Folding stabilisers** on Roto 400 series models.

▼ **Stabilisers combining extension and jacking** on Roto 600 series models. The unique Merlo automatic stabilising and levelling system makes positioning easier and safer.

◀ **Stabilisers with independent extension and jacking** on Roto MCSS. Additional load-spreading plates can be used in softer ground.



MCSS. CONTINUOUS CONTROL OF STABILITY

When Roto MCSS telehandlers are operating on their stabilisers, the continuous stability control system (MCSS: Merlin Continuous Slew Safety) constantly monitors the forces acting on the four stabiliser pads. The system uses these values to automatically calculate the position of the overall centre of gravity of machine and load. From that, the microprocessor

can determine the level of stability at that moment. If stability is less than that required for safe operation, any further aggravating movements are immediately blocked. The calculation algorithm is valid irrespective of stabiliser extension. This allows the operator to place the stabilisers as he requires, depending on the task; the load diagram will be au-

tomatically and dynamically adjusted to suit the stabiliser position chosen by the operator. The system checks machine stability automatically and continuously, so that the operator is free to focus on his work, because the load envelope is created dynamically depending on the position of the overall centre of gravity, thus ensuring maximum safety in any condition.

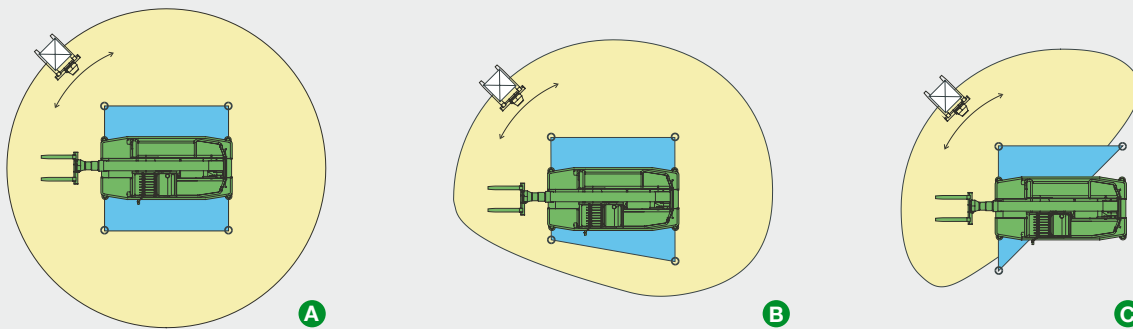

The MCSS system allows the machine to operate even when the stabilisers are placed in an unusual configuration. Whatever the stability footprint, the system dynamically creates a virtual working envelope within which the machine is fully operational. Whatever attachment is fitted, the maximum load diagram achievable for that configuration can be fully utilised (including personnel work platforms).
 When the stabilisers are fully extended (Fig. A), the working area is circular and ensures full machine operation throughout turret rotation. The working area is automatically limited by the onboard computer when, depending on the operator's needs, stabilisers are unequally extended (eg. one stabiliser is only partially extended, as shown in Fig. B).
 Another limiting condition occurs when one stabiliser is not touching the ground, eg. due to collapse of the ground under the stabiliser pad (Fig. C). In this event, too, the working area is also automatically limited.

THE ENGINE

POWER IN ACTION



GREATER EFFICIENCY ON SITE

The telehandlers of all Roto series are powered by four or six cylinder turbo diesel engines, compliant with Tier 3 emission standards, providing ample available torque throughout their operating range. A prompt response to a power demand is crucial for these machines, which need power in the most diverse of conditions.

The engine is mounted low down on the right-hand side of the chassis for greater accessibility and safer servicing, as technicians can work with their feet resting firmly on the ground, with all mechanical and hydraulic assemblies close at hand.

Merlo was the first telehandler company to adopt this layout, which has since become an industry norm.

The transmission is hydrostatic and utilises variable displacement motor and pump, ensuring high performance and a wide control range at full power. The maximum travel speed is as high as 40 kph on some models.



Permanent four-wheel drive ensures mobility on all terrain.

The high-performance engine and efficient hydrostatic transmission ensure great driving performance and safety even on slopes.



THE HYDROSTATIC TRANSMISSION

The hydrostatic transmission, which features an independent hydraulic circuit, has a high dynamic braking effect, so that the use of brakes can be minimised. Oil flow, pressured by a hydraulic pump, is sent to the hydrostatic motor which then turns it into mechanical power. This power is then transferred to the axles through a gearbox and propeller shafts. The driving speed varies depending on the pressure applied to the accelerator pedal, without the necessity to change gears as in conventional mechanical transmissions. The hydrostatic transmission is combined with a permanent four wheel drive, ensuring optimum mobility and road holding even in difficult conditions.

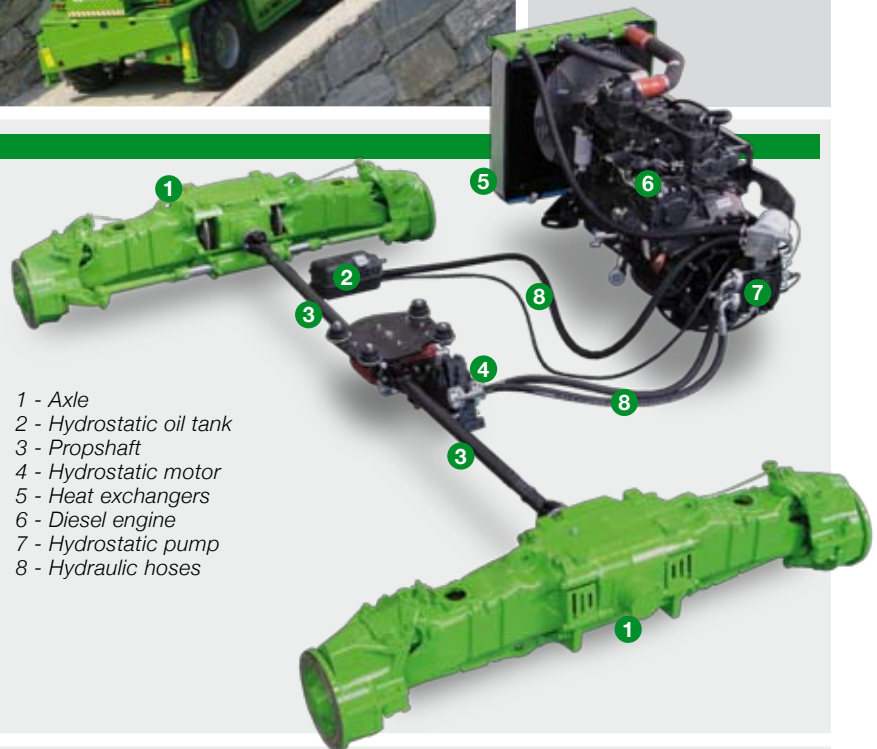

- 1 - Axle
- 2 - Hydrostatic oil tank
- 3 - Propshaft
- 4 - Hydrostatic motor
- 5 - Heat exchangers
- 6 - Diesel engine
- 7 - Hydrostatic pump
- 8 - Hydraulic hoses

THE HYDRAULIC SYSTEM

All models are equipped with a Load-Sensing hydraulic pump. Hydraulic oil delivery automatically varies depending on the demand from the various hydraulic circuits. This system is highly efficient in continuous heavy-duty operation, as it ensures power availability and a rapid response to controls whenever necessary, even when several machine systems need to

be fed simultaneously. Hydraulic oil flow always matches only that demanded through the joystick, reducing fuel consumption and increasing component durability.



DROP PORTAL AXLES

MASTER OF EVERY ROUTE



EXCLUSIVE STRENGTH AND RELIABILITY

The drop portal axles, designed and manufactured in-house by Merlo, increase both driving satisfaction and machine stability on any terrain. Designed for heavy duty applications, the concept places the main axle body above the centreline of the wheel hub. Compared with traditional axle design, it provides a greater ground clearance with equal-sized tyres.

Permanent four-wheel drive allows the machine to move easily even in the most treacherous situations.

The rear axle is freely oscillating, adapting to unevenness even in extreme off-road conditions and ensuring maximum tyre grip even on steep slopes, by reducing wheel spin.

If necessary, an optional fully-locking rear differential is available.

DROP PORTAL AXLES

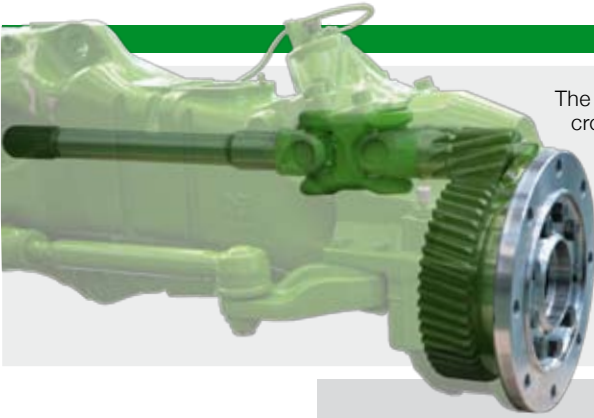

The **drop portal axles** feature a crown and pinion wheel reduction hub and provide an exceptional ground clearance. The drive train layout developed by Merlo engineers reduces both noise and pitch during braking and acceleration, improving driving comfort and load retention.

ALL WHEEL BRAKING

Servo-assisted hydraulic service disk brakes, with floating callipers, are fitted to each hub. A dual-circuit hydraulic layout is utilised to guarantee maximum safety. An **automatic parking brake is applied automatically when the engine is switched off** (or via manual selection of the appropriate switch). An independent, spring-operated disk brake, acts upon the main transmission propeller shaft.

◀ **Axle oscillation** enhances off-road performance of the machine.

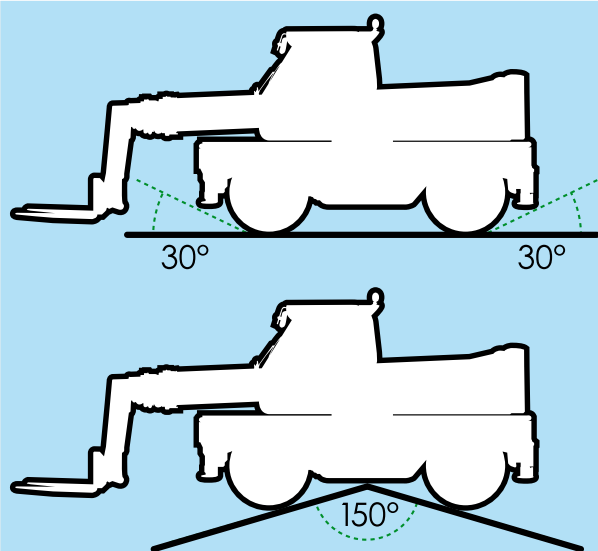

* Average values, which vary depending on the models and on suspension settings.

▶ Off-road performance is particularly impressive for its class, due to the **high angles of attack and departure**.

THREE STEERING MODES

The four drive wheels are all steered using a hydraulic power steering system.

The operator has a choice of three steering modes, and automatic wheel re-synchronisation is available in the event

of misalignment.

- **Front wheel steer** for road travel (Fig. A);
- **All wheel steer** to achieve the smallest turning radius (Fig. B);
- **Crab steer** to move the machine si-

deways without losing longitudinal alignment (Fig. C).

Thanks to its small turning radius a Roto telehandler can operate easily in both narrow streets and on the most confined jobsites.



HYDROPNEUMATIC SUSPENSION

STABILITY EVEN OFF-ROAD



THE PERFECT COMBINATION OF COMFORT AND SAFETY

An innovative, self-levelling hydropneumatic suspension, ensures optimum comfort even while driving on uneven terrain. This technology is exclusive to Merlo, ensuring effective damping irrespective of the load, terrain and driving speed, without requiring any adjustment by the driver.

The perfect combination of hydraulics and electronics within the suspension results in an active system that ensures the best possible exploitation of the telehandler's performance, while offering the operator unrivalled comfort and safety.

▶ The automatic suspension mode is ideal for off-road driving and short transits on-road, assuring **excellent vehicle stability at up to 40 kph.**



◀ The suspension can be locked in any desired position, so as to ensure the necessary **stability and safety** during any lifting operations whilst the machine is used 'on-tyres'.



▶ The controls allow the operator to set all **operating parameters.**

◀ Selecting the **manual suspension setting** allows the operator to continuously change both the side tilt by up to $\pm 9^\circ$ ($\pm 16\%$) and the longitudinal tilt by up to $\pm 5^\circ$ ($\pm 9\%$).

MERLOMOBILITY

MERLO GROUP
INFOMOBILITY*

** available only in certain territories*



YOUR TELECOMMUNICATION PARTNER PUTTING EVERYTHING UNDER YOUR CONTROL

MerloMobility is a simple, economical, and totally customisable system which computerises, manages, and locates your private and corporate vehicle fleet.

It delivers real-time location of several vehicles via GPS, and makes it possible to monitor the most significant vehicle parameters, to receive and process alarms, as well as to send commands for event management. MerloMobility transmits and receives information via the GSM/GPRS/UMTS mobile telephone network and the Internet.

The system can be accessed and used via the World Wide Web; there is no need to install complex software, since an ordinary Internet browser can access all system functions from either a PC or a PDA.

So you can find out where your vehicles are, who is using them, and under which conditions they are operating.

Furthermore, MerloMobility also works as an antitheft system in the event of unauthorised use or attempted damage.

Once again, the Merlo Group is a leader in technological innovation and research.

LOGISTICS

Vehicle location / Fleet position / Non-operating machines / Machine working hours / Fleet map / Working areas / Fuel consumption / Vehicle speed

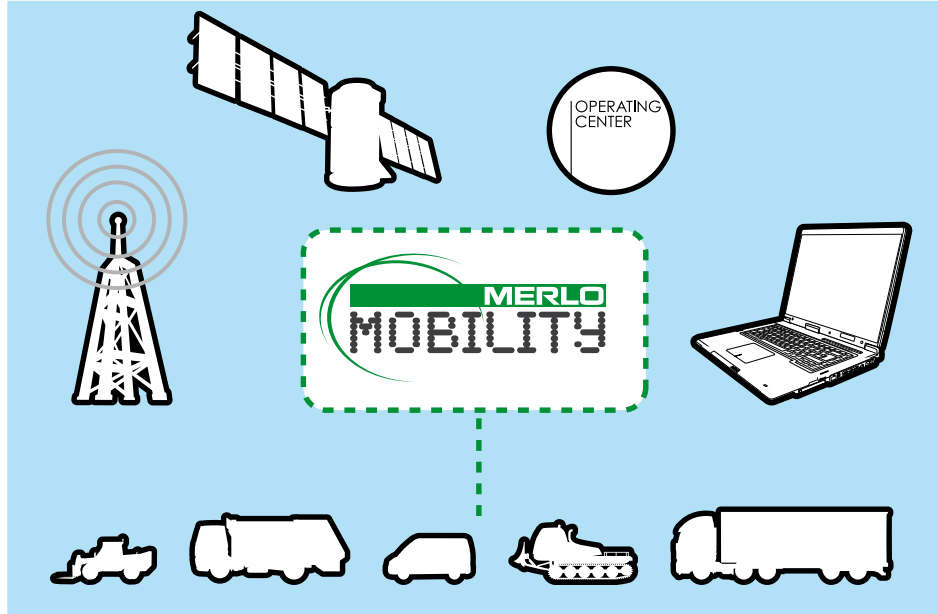

ANTITHEFT

Operating time slots / Protection against any unauthorised use / Motion alarm / Towing alarm / Engine lockout / Driver identification / Intruder detection and alarm / Displacement alarm

CAN-BUS (CONTROLLER AREA NETWORK) INTERFACE

MerloMobility allows you to **retrieve information about logistics, diagnostics and maintenance** directly from the CAN-BUS system of your vehicle. On Merlo machines equipped with either the MCSS or the Merlin system, MerloMobility is the only system that can access the readout of these proprietary signals.

DIAGNOSTICS

Engine coolant temperature / Engine oil pressure / Machine efficiency / Maintenance data / Load charts / Maintenance management / Usage reports / Event traceability

OPERATIONAL PLANNING

Work activity schedule / Trip planning / Customisations of points of interest / Route optimisation / Vehicle to driver match / Weekly and monthly statistics / Customisable charts and reports / Data export to Excel files

MERLO MOBILITY. THE BENEFITS

Regulating every journey

It will produce a detailed graphical representation and the ability to check the machine's position and every movement within a predetermined time interval.

Warning management of alarms and events

An alarm will be generated via Web, eMail or SMS message, whenever the machine performs or operates outside of preset parameters.

Accurate management information

All important machine information is recorded within the 'black box' database,

which can be readily accessed automatically or manually via the Internet. The data can be exported in Excel format.

It is highly competitive

This internal research and development allows Merlo to offer a product of the highest quality and efficiency.

Innovative technology

MerloMobility has already been integrated into many machines and will be compatible with all Merlo products.

Versatility

All functions are integrated within a single system.

Optimising time

It permits the planning, control and the programming of journeys and job tasks.

Reduced fuel consumption

The more rational use of the machine park leads to optimisation of journeys and of work activities, reducing the total of fuel used.

Reduced maintenance costs

The system signals any anomalies and permits remote diagnosis and preventive monitoring.



SPACE SYSTEM AND AERIAL PLATFORMS

SAFETY AT HEIGHT



HIGH EXPECTATIONS

Roto telehandlers are successfully used for very diverse on-site handling operations. Several Merlo interchangeable systems for lifting materials and personnel complement the forklift use of these handlers, thus offering extraordinary application. All fully comply with European Standard EN280 for Mobile Elevating Work Platforms - further proof of Merlo's supremacy in technological innovation.

The Space System is an excellent example; a high-tech access platform equipped with a telescopic boom, incorporating its own extension and slewing functions. And there are many other systems equipped with personnel baskets. Performance and safety in operation are just two of the many competitive advantages of this technology, eliminating conventional scaffoldings and mobile scaffold towers, saving time and labour costs.

This is a sure sign of Merlo's commitment to offering cutting-edge technology, the fruit of constant research and innovation, guaranteed by more than 40 years experience.



◀ The Space System can **quickly be stowed** on the Roto for convenient road travel.



▶ Several Merlo platforms have a **hydraulic slewing function**, thus making it possible to work whatever the machine's position.



▶ The useful width of this Merlo platform attachment can be adjusted with the **patented extension system**, even whilst elevated!

◀ **The Space System's telescopic boom**, on which the platform is installed, **can itself slew**, thus making it possible to reach even the least accessible places.



▶ The Space System can be configured to provide personnel access **over 9 metres below street level**.

◀ Whichever Merlo platform attachment is used, **the operator can control all its movements from inside the basket**.

MERLO ATTACHMENTS

UNLEASH THE POWER OF VERSATILITY



MANY MACHINES IN ONE

Merlo attachments are a great concept that has further enlarged the tremendous versatility of Roto telehandlers. For all models there are countless technologically advanced working tools which maximise their potential, enhance their versatility, and optimise their use in any sector. The excellent performance and characteristics of Merlo attachments are the result of integrating their engineering with the base machine design, as well as of an exclusive manufacturing process.

When equipped with Merlo attachments, Roto telehandlers offer efficiency, profitability, and significant cost savings. It takes just a few moments to connect any Merlo attachment to the fork carriage, and to meet alternate lifting, transport, loading/unloading and precision handling needs promptly and effectively.

Merlo multifunctional systems are always ready to get to work in countless different applications, and to offer their best in terms of versatility, quality, profitability and, most of all, safety.

CONCRETE MIXING BUCKET

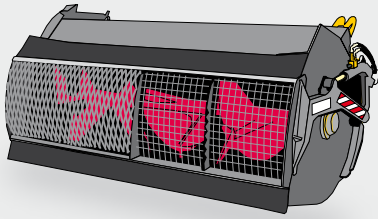

HOOK ON CARRIAGE

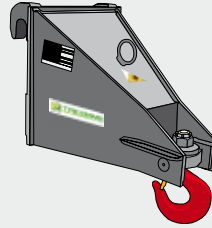

CRANE ARM

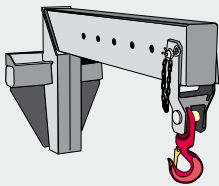

SPACE SYSTEM + TUNNEL RING POSITIONER

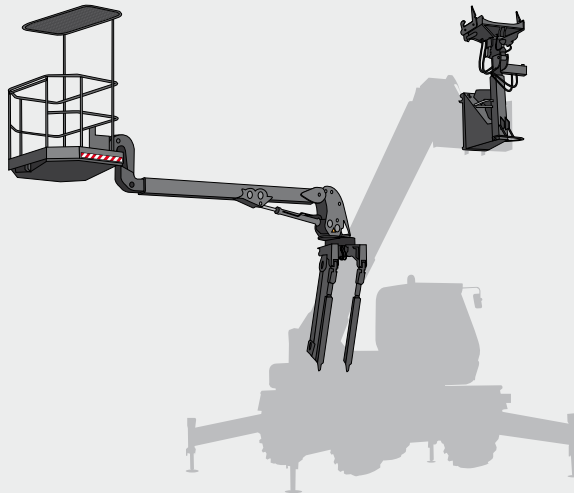

GRAB WITH ROTATOR

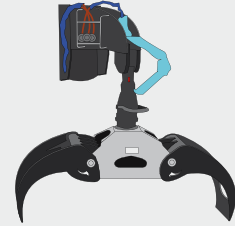

WINCH

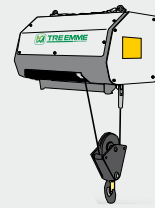

FLY JIB WITH WINCH

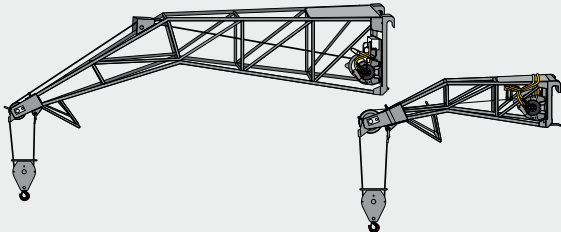

CONCRETE SKIP

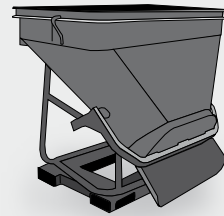

ROTO 45.21 MCTJ. THE TOWER CRANE ACCORDING TO MERLO

This special version of the Roto 45.21, the MCTJ, combines all of the normal functions of this rotary telehandler with the reach of a tower crane. The 'Tower Jib' system is fixed to the final section of the telescopic boom, and consists of a lattice structure and a cable-operated trolley. It can be operated with the jib horizontal, as a conventional tower crane, or as a jib crane, in which case it can deliver a total lift height of 31.7 m.

- The structure can be folded back along the main machine boom, permitting easy road travel and the use of the Roto in its conventional telehandler roles.



THE MERLO WORLD

ANOTHER PLANET!

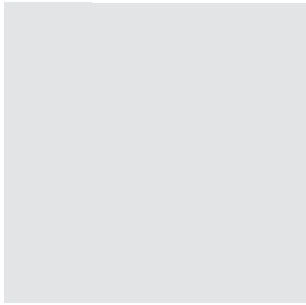

INTERNET

Let the Merlo world enthuse you on the Internet. Visit www.merlo.com

MERLO SERVICE

Nobody knows the needs and expectations of telehandler users better than we do, and our customers are aware of that. They know they can rely on **highly skilled service technicians** wherever there is a Merlo machine in operation.

A GLOBAL PRESENCE

Over **600 sales and service partners in the world** bring you those values that can only be ensured by experience and innovative technologies. Choosing Merlo means finding out the advantages offered by safe, reliable and comfortable machines from which you can really demand the most.



MERLO FINANCE

A **range of customised financial products**, with competitive economic conditions, administrative efficiency and procedural simplicity. All complemented by value-added services, such as customised insurance and contract documentation.

WELCOME ON BOARD

You can have **guided tours** in our plants and get to know our manufacturing and commercial organisation. You will find out that what we have is an integrated, full-cycle manufacturing process, not a mere assembly of components.



MERLO NEWS

This magazine, **rich in technical information and interesting articles**, is aimed at all those who work with telehandlers and lifting machines/equipment. Register on www.merlo.com to receive it for free.

MERLOMOBILITY

It's your personal assistant, meeting all your **infomobility** needs and allowing you to manage all your vehicles and machines **in real time, 24/7 all year round**. It's your telecommunications partner for diagnostics, logistics and operational planning.



CFRM - MERLO TRAINING AND RESEARCH CENTRE

The best technical skills and the most effective educational tools - certified by both **ISPESL (Italian Institute for Work Safety and Work Accident Prevention)** and **IPAF (International Powered Access Federation)** - are available to learn safe machine operation, irrespective of its kind, make or model. www.cfrm.it.



ISO 9001:2000 (VISION 2000)

Through the application of strict management procedures to each business process, our **Quality Assurance System** ensures those results that have allowed us to gain the trust of thousands of customers all over the world.



TECHNOLOGICAL RECORD

Our **modern manufacturing facilities** are the best available in the industry today: laser cutting centres, electrostatic powder coating, robotised processes, modern automated working centres. All of this allows us to set a technological record, without parallel.

MERLO PROJECT

A breeding ground for ideas and the beating heart of advanced research. **This is where today's concepts and plans turn into tomorrow's technologies**, as well as into strong machines that are impressive when they are standing still and truly amazing when in operation.

SAFETY FIRST

Dynamic crash tests, falling object protection and **structural strength tests** expose all machine systems to stress factors. A Roto telehandler must pass all these tests and many others before being manufactured in mass production and be delivered to sites all over the world.

TECHNICAL DATA

LET FIGURES SPEAK FOR THEMSELVES

CHARACTERISTICS AND PERFORMANCE	50.10 S	38.14 38.14 S	38.16 38.16 S	45.19	45.21	50.16 MCSS	45.19 MCSS	45.21 MCSS	40.25 MCSS	40.26 MCSS
Total weight unladen, with forks (kg)	11780	11920 ⁽¹⁾	12080 ⁽¹⁾	14700	14900	14200	14300	14500	15450	15450
Maximum load capacity (kg)	5000	3800	3800	4500	4500	5000	4500	4500 ⁽²⁾	4000	4000
Maximum lift height (m)	10.4	13.9	15.7	18.7	20.8	16.4	18.7	20.8 ⁽²⁾	25.3	26
Maximum forward reach (m)	7.6	11	13	15.8	18	13.4	15.9	18	22.7	22.9
Lift height at maximum load capacity (m)	9.1	9.7	9.8	10.9	10.6	10.9	11	10.7	13.6	13.6
Forward reach at maximum load capacity (m)	4.8	5.5	5.5	7	7.1	6.1	7.6	7.6	8.2	8.2
Load capacity at maximum height (kg)	4000	2500	2500	3000	2500	3000	3000	2500	1500	1500
Load capacity at maximum forward reach (kg)	2000	1100	700	650	600	1300	900	750	150	150
Turret rotation (degrees)	415 ⁽³⁾			600 ⁽³⁾		Continuous				
Engine (make/cylinder)	Perkins/4			Deutz/4		Iveco/6				
Tier 3 engine power (kW/HP)	74.5/101			88/120		107/145				
Fuel capacity (l)	150	150	150	150	150	150	150	150	150	150
Speed in the 1 st gear (kph)	16	16 ⁽⁴⁾	16 ⁽⁴⁾	7	7	16	16	16	16	16
Speed in the 2 nd gear (kph)	40	40 ⁽⁵⁾	40 ⁽⁵⁾	25	25	40	40	40	40	40
Load-Sensing hydraulic system (bar-l/min)	210-108	210-108	210-108	240-108	240-108	240-104	240-104	240-104	240-104	240-104
Hydraulic oil capacity (l)	120	120	120	150	150	150	150	150	150	150
Electrical circuit (V)	12	12	12	12	12	12	12	12	12	12
Battery (Ah)	100	100	100	160	160	160	160	160	160	160
Hydraulically controlled stabilisers	●	●	●	● ⁽⁶⁾	● ⁽⁶⁾	●	●	●	●	●
Hydropneumatic suspension	●	● ⁽⁷⁾	● ⁽⁷⁾	-	-	●	●	●	●	●
Cab compliant with FOPS standards	●	●	●	●	●	●	●	●	●	●
Tilting cab	-	-	-	-	-	-	-	-	●	●
Merlin electronic control system	-	-	-	-	-	●	●	●	●	●
Electro-mechanical joystick controls	●	●	●	●	●	-	-	-	-	-
Electronic joystick controls	-	-	-	-	-	●	●	●	●	●
Tac-Lock attachment coupling	● ⁽⁹⁾	● ⁽⁸⁾	● ⁽⁸⁾	● ⁽⁸⁾	● ⁽⁸⁾	● ⁽⁹⁾	● ⁽⁸⁾	● ⁽⁸⁾	● ⁽⁸⁾	● ⁽⁸⁾
Auxiliary boom hydraulic service	●	●	●	●	●	●	●	●	●	●
Two floating forks (1,200 mm long)	●	●	●	●	●	●	●	●	●	●
Hydrostatic transmission	●	●	●	●	●	●	●	●	●	●
Hydrostatic oil capacity (l)	12	12	12	12	12	12	12	12	12	12
Finger-Touch direction reversing control	●	●	●	●	●	●	●	●	●	●
Permanent four-wheel drive	●	●	●	●	●	●	●	●	●	●
Four wheel steering	●	●	●	●	●	●	●	●	●	●
Service disk brakes on all wheels	●	●	●	●	●	●	●	●	●	●
Tyres	405/70-20			18-22.5	18-22.5	18-22.5	18-22.5	18-22.5	18-22.5	18-22.5
Automatically locking parking brake	●	●	●	●	●	●	●	●	●	●
Radio remote control	○	○	○	○	○	○	○	○	○	○
Pneumatic seat	○	○	○	○	○	●	●	●	●	●
Rear differential lock	○	○	○	○	○	○	○	○	○	○
Four cab working lights (2 f. + 2 r.)	○	○	○	○	○	○	○	○	○	○
Manual air conditioning system	○	○	○	○	○	○	○	○	○	○
Roof window wiper	○	○	○	○	○	○	○	○	○	○
Manual battery isolator	○	○	○	○	○	○	○	○	○	○
Front and roof sun shade	○	○	○	○	○	○	○	○	○	○

Performance figures refer to the machine equipped with forks, operating on stabilisers.

(1) S version only. The basic model weighs 350 kg less; (2) Tower-Jib version with maximum lift capacity of 800 kg and maximum lift height of 31.7 m;

(3) ±208° / ±300° with reference to the longitudinal axis of the machine; (4) S version only. The basic model features 7 kph maximum speed;

(5) S version only. The basic model features 25 kph maximum speed; (6) Stabilising and levelling can be performed automatically.

(7) S version only. The basic model has no hydropneumatic suspension. (8) ZM2 version front tool holder. (9) ZM3 version front tool holder.

● Standard. ○ Optional.

The Roto telehandlers described in this document may feature optional or special equipments which are not part of the standard equipment and are supplied upon request. Not all models or versions are available in all countries, due to regulatory restrictions. For further information on models and their equipment please contact your Merlo dealer. Information and technical data are those available at the time of printing. Merlo reserves the right to modify and update the contents of this document following technological evolution.



MERLO S.P.A.

Via Nazionale, 9 - 12010 S. Defendente di Cervasca - Cuneo - Italia

Tel. +39 0171 614111 - Fax +39 0171 684101

www.merlo.com - info@merlo.com

