



JLG[®]

**Ultra Series
Boom Lifts**



JLG ULTRA BOOM

1500SJ

Ultra Series
BOOM LIFTS

Reaching Out for Ultimate Productivity.

Steel mills and chemical plants, airports, convention centers, shipyards and heavy construction. The JLG® Ultra Series boom lifts are designed for rugged job sites that demand you work higher and reach farther. With four decades of experience, JLG knows the territory. You need the power, reliability and versatility to do the impossible every day. And come back and do it again tomorrow.

JLG Ultra Series boom lifts get you there. They're built from 100,000 psi steel—40% stronger than the competition, and they'll lift 1,000 pounds, making them the most powerful booms in the industry.

When you're working ten stories high, you want a machine that gives you confidence to do your best work; that's built to perform and that's designed to meet any challenge—that's the JLG Ultra Series.



***"No other machine
allows us to reach
as high or as far."***





JLG ULTRA BOOM 1200SJP

1200SJP

JLG





Maximum Height, Reach and Power.

When your job demands both height and reach, enlist the JLG® Model 1250AJP. With over 60 ft of up and over height and 63 ft of outreach, the 1250AJP is ideal for applications that require high-reach versatility. Automatic platform leveling provides operator comfort at 125 ft. While the exclusive QuikStik® boom design delivers faster cycle speeds—115 seconds from ground to elevation—so you can get work done quickly and efficiently. JLG Ultra Series

boom lifts come with the only oscillating axle in their boom class, giving you surprising mobility in an ultra-sized package.

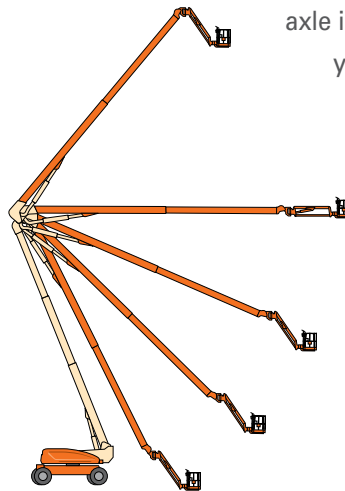

QuikStik® Advantage

Go from full platform elevation to the ground in 115 seconds.

“The larger platform gives us more room for tools and extra workers.”



Unmatched Range of Motion

With up and over height of 60 ft 6 in. (18.44 m) and 63 ft 2 in. (19.25 m) of horizontal outreach, the 1250AJP gets you where you need to work.

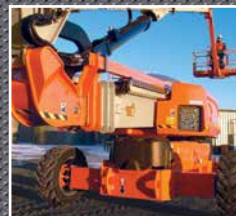

Ultra Mobility

Go where others can't thanks to the tight turning radius, three steering modes and the only oscillating axle in its class.

Ultra Series
ARTICULATING BOOM LIFTS



Work Tools

Workstation in the Sky[®] accessories provide ultimate versatility.



More Stability

Automatic platform leveling provides operator comfort at 125 ft.

Ultra Series
TELESCOPIC BOOM LIFTS



Strong 100,000 PSI Steel
The high-quality steel of the boom ensures greater durability and stability.



Larger Work Envelope
With more outreach above 50 ft, you have added access and flexibility.

Taking Productivity to Greater Heights.

Dominate the job site with the JLG® Ultra Series. When you're facing tall challenges, you want a solid machine that goes above and beyond the day's demands. The rugged boom gives you the confidence and support you need to handle 1,000 lb capacity. The exclusive controlled arc regulates speeds at the edges of the work envelope so that you feel the same velocity in all positions for enhanced comfort.

"The high capacity platforms raise our productivity, and level of work."



Oscillating Axle

Standard on all Ultra Booms, oscillating axle and full-time four-wheel drive provide superior traction.



SkyPower®

A 7,500-watt on-board generator gives you the extra boost you need.

Extend Your Reach with the 1500SJ.

The Model 1500SJ is the largest self-propelled telescopic boom available from JLG—the first straight boom lift that takes you to 150 ft without an oversized load permit (over weight permit is required for highway transportation). The 1500SJ features a telescoping jib for greater work envelope flexibility and additional outreach at elevation.

“At 150 ft, I want to focus on my work with confidence. The Ultra Series lets me do just that.”



More Capacity

With a dual 1,000/500 lb capacity, the platform can handle more workers, tools or materials.



Greater Reach

The JibPLUS® boom adds an extra 30 ft of outreach.*

*Capacity restricted to 500 lb (227 kg) when the jib is in side-swing mode. JibPLUS for transport only for 1500SJ.

Ultra Series
TELESCOPIC BOOM LIFTS



More Maneuverability

Full-time four-wheel drive gets you over rough terrain.



Ease of Transport

No oversized load permit needed.

Workstation in the Sky® Accessories.

Turn your Ultra Series boom lift into a versatile, productivity-enhancing machine with exclusive Workstation in the Sky® products. Our accessories are built to conserve platform space, improve working conditions and turn your lift into one giant work tool.

SkyPower® Package

The SkyPower® system includes a self-contained 7500W continuous output generator with a power cable, and an air/water line installed in the power track. In addition, it provides self-contained 110V AC, 220V AC, and 3-phase power to run hand tools and other accessories.

SkyWelder® Package

With a 280 amp Miller® CST 280 welder tucked into the SkyPower platform, space is conserved while providing stick and TIG capability. The SkyWelder package eliminates potentially dangerous leads hanging over the rails and the unnecessary cost of a stand-alone welder and power supply.

SkyCutter® Package

Eliminating the danger of tanks and draping hoses, SkyCutter® cuts faster and cleaner with an on-board Miller Spectrum 375 Cutmate plasma cutter.

SkyGlazier® Package

The first and only factory-approved glass and panel tray. Panels are protected from damage and productivity is improved while operator fatigue is reduced. And with JLG® 1,000 lb capacity, the basket can hold multiple workers and larger glass panels.

SkyAir® Package

With an integrated on-board air compressor, the SkyAir® package delivers 9.3 CFM at pressures up to 125 psi. It increases productivity by eliminating the need for a ground-based compressor.

Nite Bright® Package

This package consists of 40-watt lights to illuminate your work site and the area around the chassis for increased visibility. It is perfect for tunnel or mine applications, nighttime work or any job with low lighting levels.





Putting Your Work Above Everything.

When it comes to JLG® Ground Support, it's all about you. Your productivity. Your profitability. Your uptime. From the purchase of your first piece of equipment straight through to the training, parts and maintenance that follows.



■ Customer Service Call Center

You can be assured we'll be giving an all-out effort to support you. Just think of us as your personal on-call, full-service support team. We make it happen. Period.

■ Financial Solutions

Maximizing your profits. Preserving your cash flow. Let our financing specialists help choose the program designed specifically for your needs.

■ Aftermarket Parts

Keep your equipment running at peak performance with genuine replacement parts, accessories, attachments, rebuilt and competitive parts all from one source—JLG.

■ Training

Knowing your equipment inside and out results in higher productivity on the job. Our instructor-led courses give you the hands-on time you need to successfully operate equipment.

■ Service Centers

Your needs. Your uptime. JLG is on the job to fulfill your every need, from repair, reconditioning, same-day parts and much more. We're here to support you.

■ Pre-Owned Equipment

As a high-value alternative to purchasing new equipment, you can search our used equipment inventory of pre-owned JLG and competitor products.

ULTRA SERIES ARTICULATING BOOM LIFTS SPECIFICATIONS

1250AJP

Ultra Series Articulating Boom Lifts

Reach Specifications

Platform Height	125 ft (38.1 m)
Horizontal Reach	63 ft 2 in. (19.25 m)
Up and Over Height	60 ft 6 in. (18.44 m)
Swing	360° Continuous
Platform Capacity—Restricted	1,000 lb (454 kg)
Platform Capacity—Unrestricted	500 lb (227 kg)
Platform Rotator	180°
JibPLUS®	
Length	8 ft (2.44 m)
Horizontal Motion ¹	125°
Vertical Motion	130° (+75/-55)

Dimensional Data

A. Platform Size	36 x 96 in. (0.91 x 2.44 m)
B. Overall Width	Axles Retracted 8 ft 2 in. (2.49 m)
Overall Width	Axles Extended 12 ft 6 in. (3.81 m)
C. Tailswing	3 ft (91 cm)
D. Stowed Height	10 ft (3.05 m)
E. Overall Length	Jib Stowed 37 ft 7 in. (11.45 m)
Overall Length	Jib Deployed 47 ft 6 in. (14.48 m)
F. Wheel Base	12 ft 6 in. (3.81 m)
G. Ground Clearance	Axle 12 in. (30 cm)
Chassis 25.5 in. (65 cm)	
Weight ²	44,000 lb (19,958 kg)

Chassis

Max Ground Bearing Pressure*	100 psi (7.03 kg/cm ²)
Drive Speed	3.25 mph (5.2 km/h)
Gradeability	45%
Turning Radius (Inside)	Axles Retracted 14 ft 5 in. (4.39 m)
Axles Extended 8 ft (2.44 m)	
Turning Radius (Outside)	Axles Retracted 22 ft 6 in. (6.86 m)
Axles Extended 19 ft 4 in. (5.89 m)	
Crab Steer Ratio ³	1:1
Axle Oscillation	8 in. (20 cm)
Tires/Type	445/50D710 Foam Filled

Power Source

Diesel Engine	Deutz TD2011L4	74.9 hp (55.9 kW)
Fuel Tank Capacity		31 gal (117 L)
Hydraulic Reservoir		53 gal (200 L)
Auxiliary Power		12V DC
Generator Nominal/Continuous		7,500 Watt

*Ground bearing pressure applies to standard tires.

- Capacity is limited to 500 lb (227 kg) when JibPLUS is extended horizontally.
- Certain options or country standards increase weight.
- Ratio of forward travel to lateral travel.

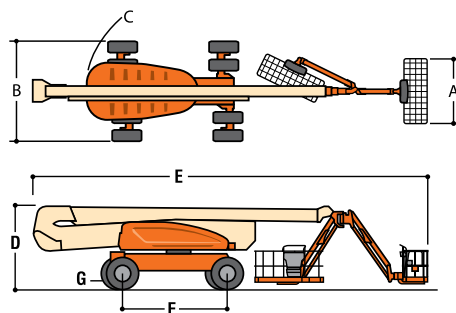

Standard Features

Platform: 36 x 96 in. (0.91 x 2.44 m) Side Entry
 8 ft (2.44 m) JibPLUS® Boom
 Selectable Capacity Envelope
 180° Hydraulic Platform Rotator
 AC Receptacle in the Platform
 SkyPower® Package
 7500 Watt Generator
 • 240/120V Single Phase
 • 240V 3 Phase
 1/2 in. Air Line to Platform
 5 Degree Tilt Alarm/Indicator Light
 All Motion Alarm
 Swing-Out Engine Tray
 12V DC Auxiliary Power
 Hourmeter
 Control ADE® System
 Full-time 4WD
 3 Selectable Steering Modes
 Drive-out Extendible Axles
 Oscillating Axle
 Proportional Controls
 Gull-Wing Hoods
 445/50D710 Foam Filled Rim
 Protector Lug Tread Tires
 Platform Console Machine Status
 Light Panel*
 Lifting/Tie Down Lugs
 Engine Distress Warning/Shutdown—
 Selectable via JLG Analyzer

Available Options

Platform: 36 x 72 in. (0.91 x 1.83 m) Side Entry
 Fall-Arrest Platform: 36 x 96 in. (0.91 x 2.44 m) Side Entry
 Self-Closing Gate
 Light Package¹
 Flashing Beacon
 Soft-Touch System Platform
 6 ft/8 ft (1.83 m/2.44 m)
 Clearsky (US and Canada only)
 Cold Weather Start²
 Hostile Environment Kit³
 Mesh to Top Rail
 Operator Tool Tray

- Includes platform mounted work lights and drive/backup lights.
- Includes glow plugs, battery heater and oil tank heater.
- Includes console cover, boom wipers and cylinder bellows.

Accessory Packages

SkyWelder®
 SkyCutter®
 SkyGlazier®
 Nite Bright®
 Pipe Racks

* Provides indicator lights at platform control console for system distress, fuel level, low fuel, 5 degree tilt light and foot switch status.

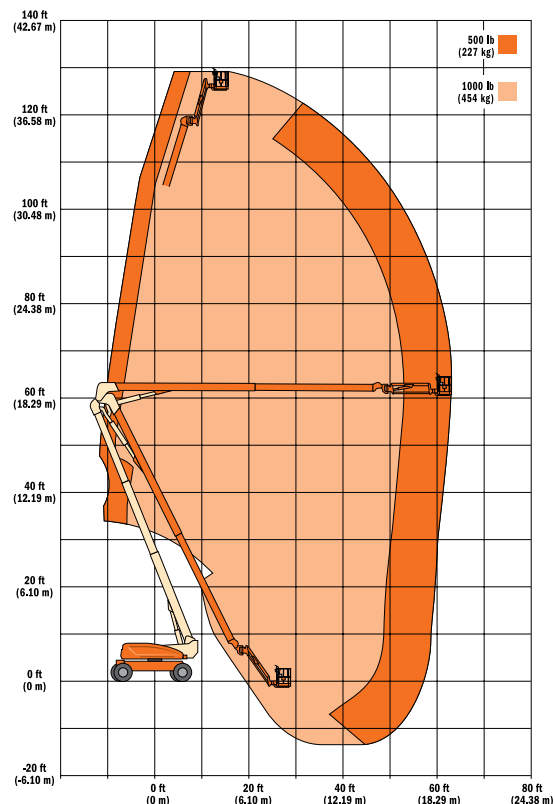

ULTRA SERIES ARTICULATING BOOM LIFTS SPECIFICATIONS

1200SJ

Ultra Series Telescopic Boom Lifts

Reach Specifications

Platform Height	120 ft (36.58 m)
Horizontal Reach	75 ft (22.86 m)
Up and Over Height	—
Swing	360° Continuous
Platform Capacity—Restricted	1,000 lb (454 kg)
Platform Capacity—Unrestricted	500 lb (227 kg)
Platform Rotator	180°
JibPLUS®	
Length	8 ft (2.44 m)
Horizontal Motion ¹	180°
Vertical Motion	130° (+75/-55)

Dimensional Data

A. Platform Size		36 x 96 in. (0.91 x 2.44 m)
B. Overall Width	Axles Retracted	8 ft 2 in. (2.49 m)
Overall Width	Axles Extended	12 ft 6 in. (3.81 m)
C. Tailswing		5 ft 6 in. (1.67 m)
D. Stowed Height		10 ft (3.05 m)
E. Overall Length	Jib Stowed	34 ft 11 in. (10.64 m)
Overall Length	Jib Deployed	44 ft 10.25 in. (13.67 m)
F. Wheel Base		12 ft 6 in. (3.81 m)
G. Ground Clearance	Axle	12 in. (30 cm)
Chassis		25.5 in. (65 cm)
Weight ²		40,900 lb (18,552 kg)

Chassis

Max Ground Bearing Pressure*		99 psi (7.0 kg/cm ²)
Drive Speed		3.25 mph (5.2 km/h)
Gradeability		45%
Turning Radius (Inside)	Axles Retracted	14 ft 5 in. (4.39 m)
	Axles Extended	8 ft (2.44 m)
Turning Radius (Outside)	Axles Retracted	22 ft 6 in. (6.86 m)
	Axles Extended	19 ft 4 in. (5.89 m)
Crab Steer Ratio ³		1:1
Axle Oscillation		12 in. (30 cm)
Tires/Type		445/50D710 Foam Filled

Power Source

Diesel Engine	Deutz TD2011L4	74.9 hp (55.9 kW)
Fuel Tank Capacity		31 gal (117 L)
Hydraulic Reservoir		55 gal (208 L)
Auxiliary Power		12V DC
Generator		7500 Watt

*Ground bearing pressure applies to standard tires.

- Capacity is limited to 500 lb (227 kg) when JibPLUS is extended horizontally.
- Certain options or country standards increase weight.
- Ratio of forward travel to lateral travel.

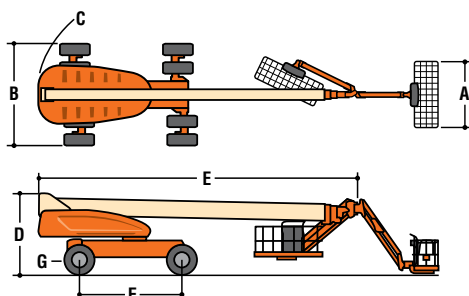

Standard Features

Platform: 36 x 96 in. (0.91 x 2.44 m) Side Entry
 8 ft (2.44 m) JibPLUS® Boom
 Selectable Capacity Envelope
 180° Hydraulic Platform Rotator
 AC Receptacle in the Platform
 SkyPower® Package
 7500 Watt Generator
 • 240/120V Single Phase
 • 240V 3 Phase
 1/2 in. Air Line to Platform
 5 Degree Tilt Alarm/Indicator Light
 All Motion Alarm
 Swing-Out Engine Tray
 12V DC Auxiliary Power
 Hourmeter
 Control ADE® System
 Full-time 4WD
 3 Selectable Steering Modes
 Drive-out Extendible Axles
 Oscillating Axle
 Proportional Controls
 Gull-Wing Hoods
 445/50D710 Foam Filled Rim Protector Lug Tread Tires
 Platform Console Machine Status Light Panel*
 Lifting/Tie Down Lugs
 Engine Distress Warning/Shutdown—Selectable via JLG Analyzer

Platform: 36 x 72 in. (0.91 x 1.83 m) Side Entry
 Fall-Arrest Platform: 36 x 96 in. (0.91 x 2.44 m) Side Entry
 Self-Closing Gate
 Light Package¹
 Flashing Beacon
 Soft-Touch System Platform
 6 ft/8 ft (1.83 m/2.44 m)
 Clearsky (US and Canada only)
 Cold Weather Start²
 Hostile Environment Kit³

- Mesh to Top Rail
 Operator Tool Tray
- Includes platform mounted work lights and drive/backup lights.
 - Includes glow plugs, battery heater and oil tank heater.
 - Includes console cover, boom wipers and cylinder bellows.

Accessory Packages

SkyWelder®
 SkyCutter®
 SkyAir® (1200/1350SJ only)
 SkyGlazier®
 Nite Bright®
 Pipe Racks

* Provides indicator lights at platform control console for system distress, fuel level, low fuel, 5 degree tilt light and foot switch status.

Available Options

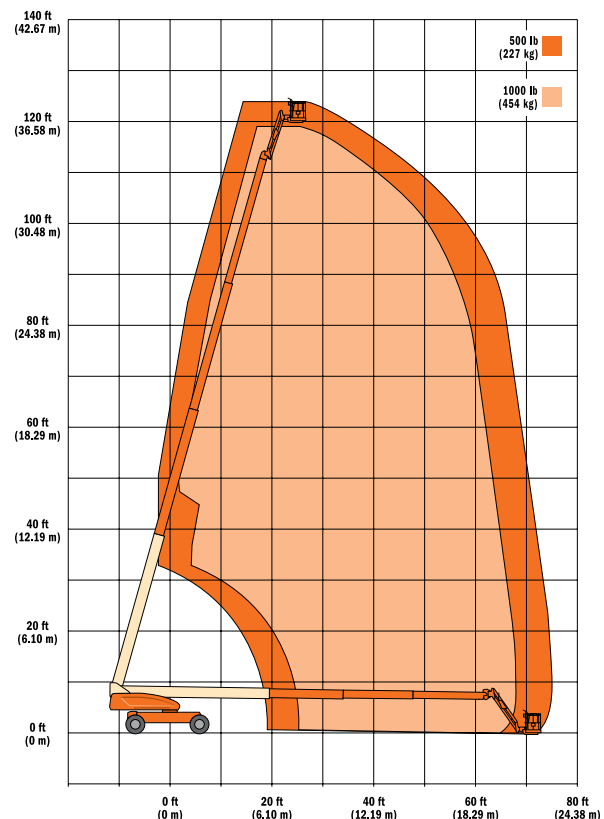

ULTRA SERIES ARTICULATING BOOM LIFTS SPECIFICATIONS

1350SJP

Ultra Series Telescopic Boom Lifts

Reach Specifications

Platform Height	135 ft (41.15 m)
Horizontal Reach	80 ft (24.38 m)
Up and Over Height	—
Swing	360° Continuous
Platform Capacity—Restricted	1,000 lb (454 kg)
Platform Capacity—Unrestricted	500 lb (227 kg)
Platform Rotator	180°
JibPLUS®	
Length	8 ft (2.44 m)
Horizontal Motion ¹	180°
Vertical Motion	130° (+75/-55)

Dimensional Data

A. Platform Size	36 x 96 in. (0.91 x 2.44 m)
B. Overall Width	Axles Retracted 8 ft 2 in. (2.49 m)
Overall Width	Axles Extended 12 ft 6 in. (3.81 m)
C. Tailswing	5 ft 6 in. (1.67 m)
D. Stowed Height	10 ft (3.05 m)
E. Overall Length	Jib Stowed 38 ft 11 in. (11.86 m)
Overall Length	Jib Deployed 48 ft 10.25 in. (14.89 m)
F. Wheel Base	12 ft 6 in. (3.81 m)
G. Ground Clearance	Axle 12 in. (30 cm)
Chassis 25.5 in. (65 cm)	
Weight ²	45,000 lb (20,411 kg)

Chassis

Max Ground Bearing Pressure*	107 psi (7.52 kg/cm ²)
Drive Speed	3.25 mph (5.2 km/h)
Gradeability	45%
Turning Radius (Inside)	Axles Retracted 14 ft 5 in. (4.39 m)
Axles Extended 8 ft (2.44 m)	
Turning Radius (Outside)	Axles Retracted 22 ft 6 in. (6.86 m)
Axles Extended 19 ft 4 in. (5.89 m)	
Crab Steer Ratio ³	1:1
Axle Oscillation	12 in. (30 cm)
Tires/Type	445/50D710 Foam Filled

Power Source

Diesel Engine	Deutz TD2011L4	74.9 hp (55.9 kW)
Fuel Tank Capacity	31 gal (117 L)	
Hydraulic Reservoir	55 gal (208 L)	
Auxiliary Power	12V DC	
Generator Nominal/Continuous	7,500 Watt	

*Ground bearing pressure applies to standard tires.

- Capacity is limited to 500 lb (227 kg) when JibPLUS is extended horizontally.
- Certain options or country standards increase weight.
- Ratio of forward travel to lateral travel.

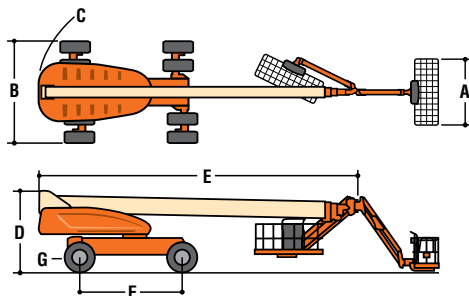

Standard Features

Platform: 36 x 96 in. (0.91 x 2.44 m) Side Entry
8 ft (2.44 m) JibPLUS® Boom
Selectable Capacity Envelope
Inward Swinging Gate
180° Hydraulic Platform Rotator
AC Receptacle in the Platform
SkyPower® Package
7500 Watt Generator
• 240/120V Single Phase
• 240V 3 Phase
1/2 in. Air Line to Platform
5 Degree Tilt Alarm/Indicator Light
All Motion Alarm
Swing-Out Engine Tray
12V DC Auxiliary Power
Hourmeter
Control ADE® System
Full-time 4WD
3 Selectable Steering Modes
Drive-out Extendible Axles
Oscillating Axle
Proportional Controls
Gull-Wing Hoods
445/50D710 Foam Filled Rim
Protector Lug Tread Tires
Platform Console Machine Status
Light Panel*
Lifting/Tie Down Lugs
Engine Distress Warning/Shutdown—
Selectable via JLG Analyzer

Available Options

Platform: 36 x 72 in. (0.91 x 1.83 m) Side Entry
Fall-Arrest Platform: 36 x 96 in. (0.91 x 2.44 m) Side Entry
Self-Closing Gate
Light Package¹
Flashing Beacon
Soft-Touch System Platform
6 ft/8 ft (1.83 m/2.44 m)
Clearsky (US and Canada only)
Cold Weather Start²
Hostile Environment Kit³
Mesh to Top Rail
Operator Tool Tray
1. Includes platform mounted work lights and drive/backup lights.
2. Includes glow plugs, battery heater and oil tank heater.
3. Includes console cover, boom wipers and cylinder bellows.

Accessory Packages

SkyWelder®
SkyCutter®
SkyAir® (1200/1350SJP only)
SkyGlazier®
Nite Bright®
Pipe Racks

* Provides indicator lights at platform control console for system distress, fuel level, low fuel, 5 degree tilt light and foot switch status.

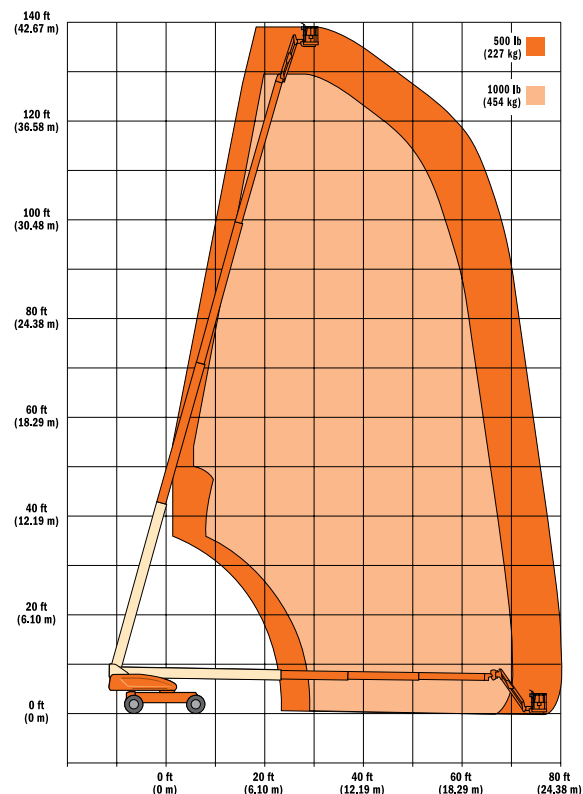

ULTRA SERIES ARTICULATING BOOM LIFTS SPECIFICATIONS

1500SJ

Ultra Series Telescopic Boom Lifts

Reach Specifications

Platform Height	150 ft (45.7 m)	
Horizontal Reach	80 ft (24.38 m)	
Up and Over Height	—	
Swing	360° Continuous	
Platform Capacity—Restricted	1,000 lb (454 kg)	
Platform Capacity—Unrestricted	500 lb (227 kg)	
Platform Rotator	180°	
Jib	Length	15 ft 2 in.—25 ft (4.62 m—7.62 m)
	Horizontal Motion ¹	For Transport Only
	Vertical Motion	120° (+75/-45)

Dimensional Data

A. Platform Size	36 x 96 in. (0.91 x 2.44 m)		
B. Overall Width	Axles Retracted	8 ft 2 in. (2.49 m)	
	Overall Width	Axles Extended	12 ft 6 in. (3.81 m)
C. Tailswing	5 ft 6 in. (1.67 m)		
D. Stowed Height	10 ft (3.05 m)		
E. Overall Length	Jib Stowed	43 ft (11.45 m)	
	Overall Length	Jib Deployed	61 ft 9 in. (18.82 m)
F. Wheel Base	12 ft 6 in. (3.81 m)		
G. Ground Clearance	Axle	12 in. (30 cm)	
	Chassis	25.5 in. (65 cm)	
Weight ²	48,000 lb (21,773 kg)		

Chassis

Max Ground Bearing Pressure*	113 psi (7.94 kg/cm ²)	
Drive Speed	3.0 mph (4.8 km/h)	
Gradeability	40%	
Turning Radius (Inside)	Axles Retracted	14 ft 5 in. (4.39 m)
	Axles Extended	8 ft (2.44 m)
Turning Radius (Outside)	Axles Retracted	22 ft 6 in. (6.86 m)
	Axles Extended	19 ft 4 in. (5.89 m)
Crab Steer Ratio ³	1:1	
Axle Oscillation	12 in. (30 cm)	
Tires/Type	445/50D710 Foam Filled	

Power Source

Diesel Engine	Deutz TD2011L04	74.9 hp (55.9 kW)
Fuel Tank Capacity	31 gal (117 L)	
Hydraulic Reservoir	55 gal (208 L)	
Auxiliary Power	12V DC	
Generator	7,500 Watt	

*Ground bearing pressure applies to standard tires.

- Capacity is limited to 500 lb (227 kg) when Jib is extended.
- Certain options or country standards increase weight.
- Ratio of forward travel to lateral travel.

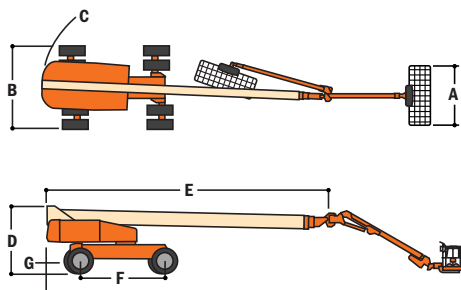

Standard Features

Platform: 36 x 96 in. (0.91 x 2.44 m) Side Entry
 8 ft (2.44 m) JibPLUS® Boom
 Selectable Capacity Envelope
 180° Hydraulic Platform Rotator
 AC Receptacle in the Platform
 SkyPower® Package
 7500 Watt Generator
 • 240/120V Single Phase
 • 240V 3 Phase
 1/2 in. Air Line to Platform
 5 Degree Tilt Alarm/Indicator Light
 All Motion Alarm
 Swing-Out Engine Tray
 12V DC Auxiliary Power
 Hourmeter
 Control ADE® System
 Full-time 4WD
 3 Selectable Steering Modes
 Drive-out Extendible Axles
 Oscillating Axle
 Proportional Controls
 Gull-Wing Hoods
 445/50D710 Foam Filled Rim
 Protector Lug Tread Tires
 Platform Console Machine Status
 Light Panel*
 Lifting/Tie Down Lugs
 Engine Distress Warning/Shutdown—
 Selectable via JLG Analyzer

Available Options

Platform: 36 x 72 in. (0.91 x 1.83 m) Side Entry
 Fall-Arrest Platform: 36 x 96 in. (0.91 x 2.44 m) Side Entry
 Self-Closing Gate
 Light Package¹
 Flashing Beacon
 Soft-Touch System Platform
 6 ft/8 ft (1.83 m/2.44 m)
 Clearsky (US and Canada only)
 Cold Weather Start²
 Hostile Environment Kit³
 Mesh to Top Rail
 Operator Tool Tray
 1. Includes platform mounted work lights and drive/back-up lights.
 2. Includes glow plugs, battery heater and oil tank heater.
 3. Includes console cover, boom wipers and cylinder bellows.

Accessory Packages

SkyWelder®
 SkyCutter®
 SkyAir® (1200/1350SJ only)
 SkyGlazier®
 Nite Bright®
 Pipe Racks

* Provides indicator lights at platform control console for system distress, fuel level, low fuel, 5 degree tilt light and foot switch status.

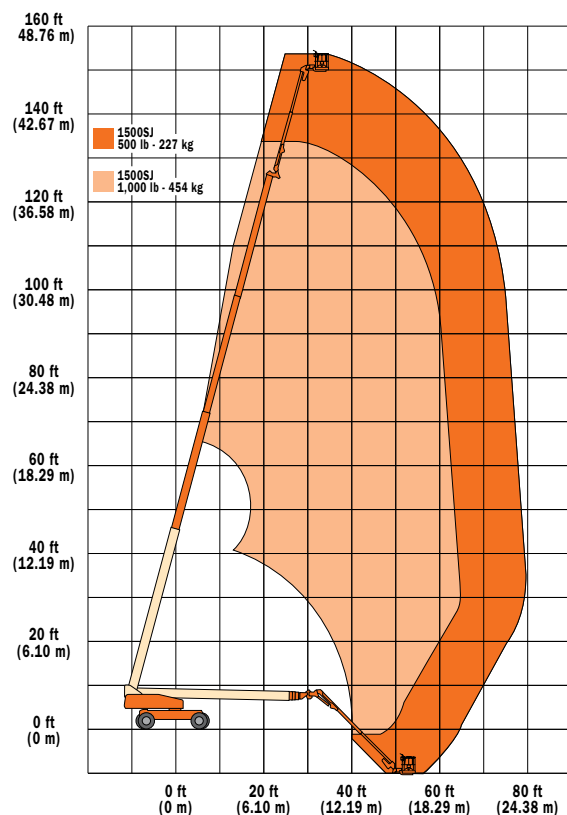



An Oshkosh Corporation Company

JLG Industries, Inc.

1 JLG Drive
McConnellsburg, PA 17233-9533
Telephone 717-485-5161
Toll-free in US 877-JLG-LIFT
Fax 717-485-6417

www.jlg.com

An Oshkosh Corporation Company

The JLG "1 & 5" Warranty

JLG Industries, Inc. backs our products with our exclusive "1 & 5" Warranty. We provide coverage for one (1) full year, and cover all specified major structural components for five (5) years. These machines meet or exceed applicable OSHA Regulations in 29 CFR 1910.67, 29 CFR 1926.453, ANSI A92.5-2006 and CSA standard B354.4-02 as originally manufactured for intended applications. We reserve the right to make price, specification, and/or equipment changes without prior notification.

Form No.: UB-BRO-0108
Part No.: 3131561
R071205
Printed in USA