



**ROUGH TERRAIN CRANE
RT 345-1 XL**

DATASHEET - IMPERIAL

RT 345-1 XL



Features:

- ▶ Rated capacity:
45 ton @ 9 ft working radius
- ▶ Maximum boom length:
105 ft
- ▶ Maximum tip height:
147 ft

WORKS FOR YOU.™

Key

.....	3
-------	---

Dimensions









































Crane dimensions	4
Crane weights	5

Load charts

Range Diagram – Main Boom – Outriggers fully extended (100%)	6
Load Chart – Main Boom – Outriggers fully extended (100%)	7
Range Diagram – Main Boom – Outriggers fully retracted (0%)	8
Load Chart – Main Boom – Outriggers fully retracted (0%)	9
Range Diagram – Main Boom – 32 ft offsettable jib	10
Load Chart – Main Boom – 32 ft offsettable jib	11
Range Diagram – Main Boom – 49 ft offsettable jib	12
Load Chart – Main Boom – 49 ft offsettable jib	13
Range Diagram – Main Boom – On tires	14
Load Chart – Main Boom – On tires	15

Technical description

Boom	16
Hoist, rope and hook	16, 17
Superstructure	17
Cab, controls, operator aids and load limiter / load indicator	17, 18
Carrier, engine, drive-line and hydraulic system	18
Vehicle performance	19
Tires	19

	Counterweight		General performance
	Main boom		Telescoping mode
	Boom length		Boom luffing angle
	Tip height		Working radius
	Boom with extension		Max. boom length with extension
	Main boom with aux head		Distance from the hook to the head sheave pin
	Slewing / Allowable slewing range		Slewing locked / Slewing locked at specified position
	Slewing brake		Slewing gears
	Outriggers / Lifting on outriggers (100/50/0% extended)		Lifting on wheels / Pick & Carry
	1 Main hoist		2 Auxiliary hoist
	Hoist speed		Rope length
	Rope - Standard / Optional		Max. line pull
	Rope diameter		Tire
	Hook block		Controls
	Cab		Engine
	Operator aids / Load limiter / Load indicator		Steering
	Mechanical transmission		Speed
	HYDR Hydraulics		Heating / Air conditioning
	Working temperature		Gradeability
	Lights		Gross vehicle weight
	Crane / Crane in standard configuration		Weight on front axle
	Crane without counterweight		Weight on rear axle

CRANE DIMENSIONS

RT 345-1 XL

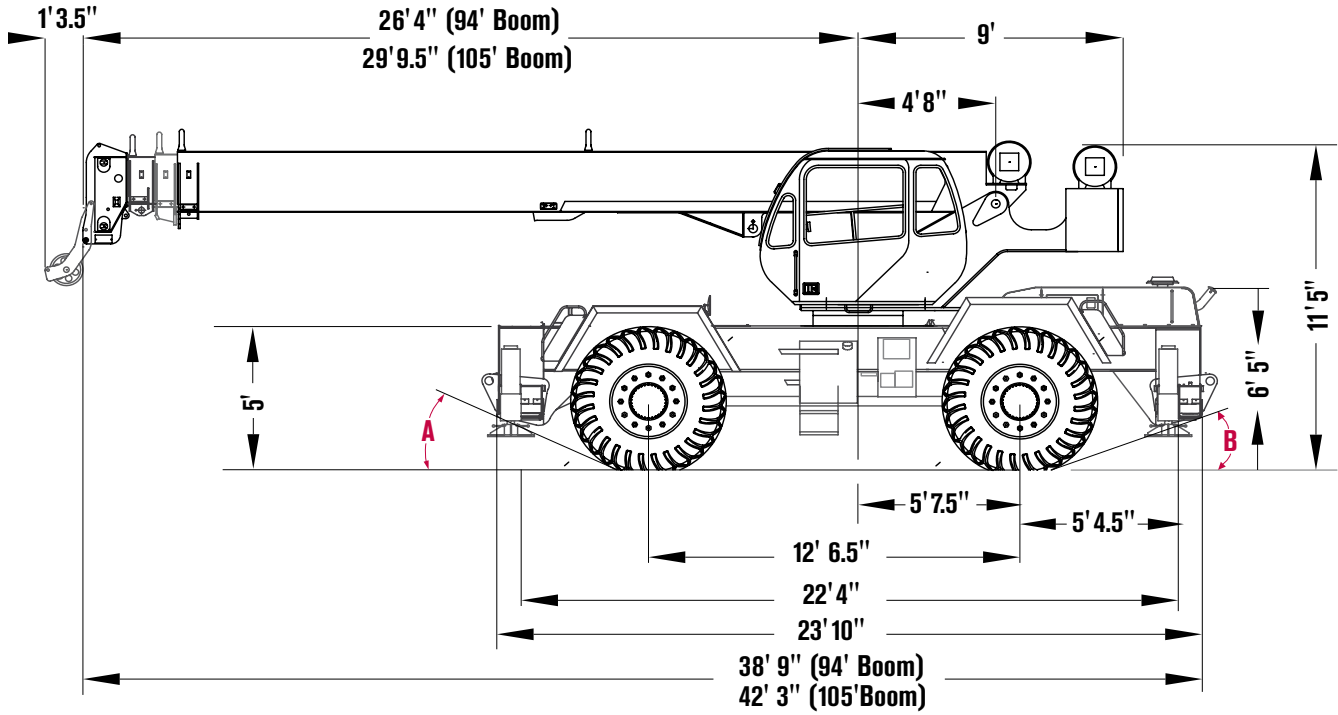

Tire Variances	23R25	21 x 25
A (Approach Angle)	22°	26°
B (Departure Angle)	18°	21°
C (Tire Track)	8'-2"	7'-10"
D (Overall Width)	10'-2"	9'-10"

Note: All heights are based on 23.5R25 tires. Use of 21x25 tires will increase dimensions by 3".

Outrigger Spread	
From Jack CL to Jack CL	
Fully Extended	22"
Mid-Position	15'-7"
Fully Retracted	9'-1.5"

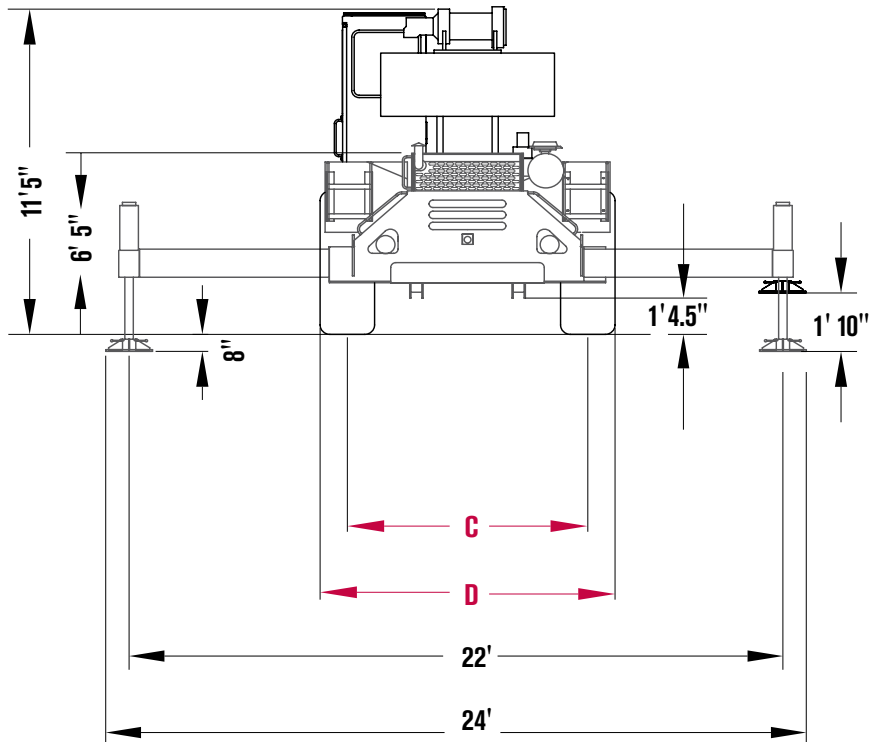

CRANE WEIGHTS

RT 345-1 XL

Approximate Weights

	STD (without hook block and auxiliary hoist)	67,915 lb	34,527 lb	33,388 lb
Add / Subtract for main optional equipment				
	32 ft to 49 ft swing on jib stowed	+ 1,789 lb	+ 1,343 lb	+ 446 lb
	Auxiliary boom head	+ 100 lb	+ 170 lb	- 70 lb
	Auxiliary hoist*	+ 264 lb	- 56 lb	+ 320 lb
	4 sheaves, 45T	+ 736 lb	+ 1,084 lb	- 348 lb
	4 sheaves, 40T	+ 690 lb	+ 1,017 lb	- 327 lb
	3 sheaves, 30T	+ 670 lb	+ 987 lb	- 317 lb
	2 sheaves, 25T	+ 682 lb	+ 1,005 lb	- 323 lb

NOTE: Values are subject to 2% variation

* Weight includes rope

RANGE DIAGRAM - MAIN BOOM

RT 345-1 XL

Outriggers Fully Extended (100%)

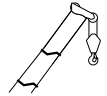

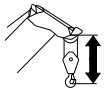
 with hook block:
6 ft

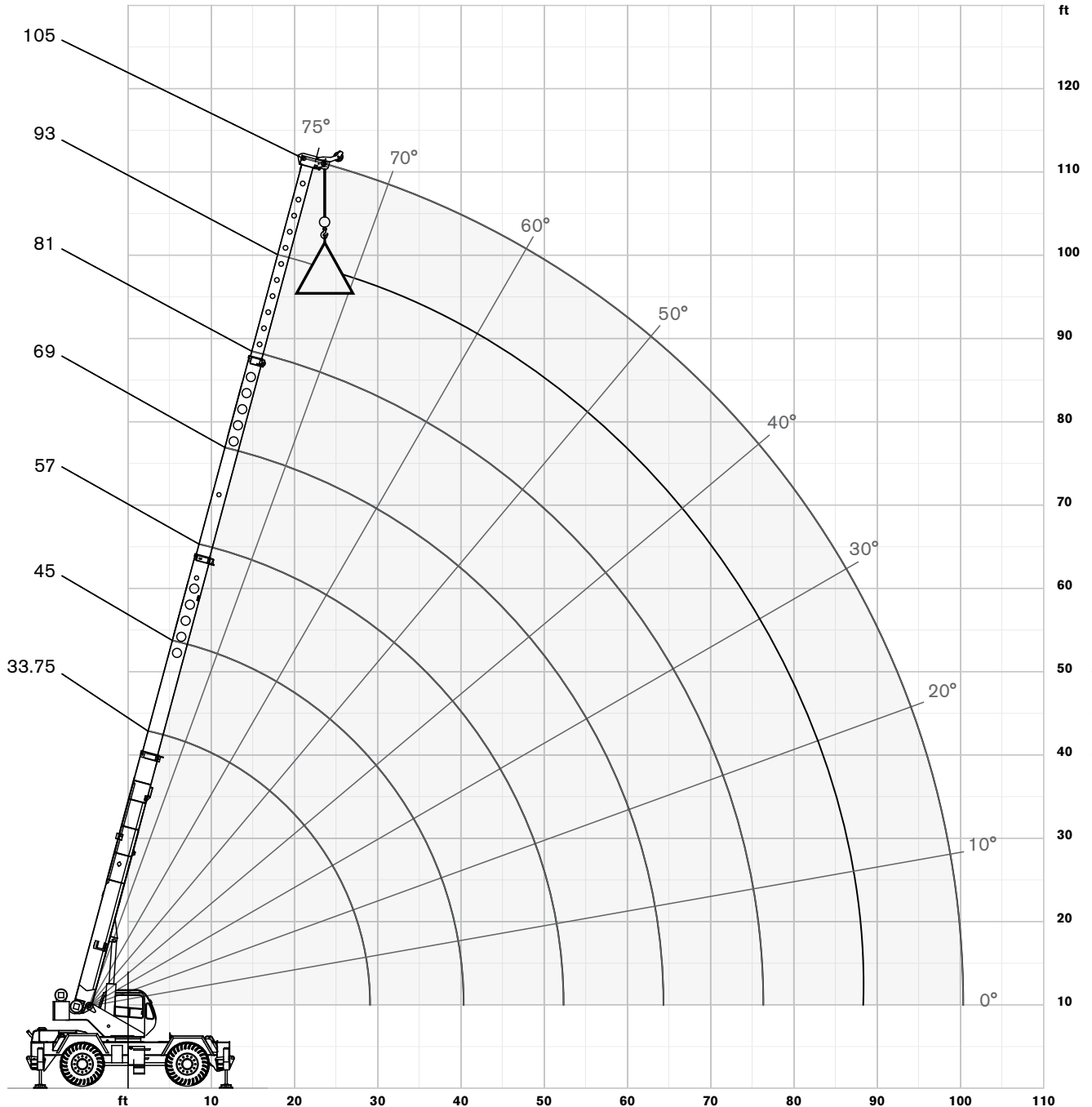



LOAD CHART- MAIN BOOM

RT 345-1 XL

Outriggers Fully Extended (100%)

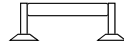
 13,000 lbs counterweight

 Outriggers extended 22 ft (100%)

 360 degree rotation

Standard ASME B30.5

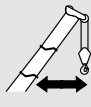
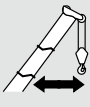
	Boom Length							
	33.75 ft	45 ft	57 ft	69 ft	81 ft	93 ft	105 ft	
ft	lb	lb	lb	lb	lb	lb	lb	ft
9	90,000							9
10	64,400	46,500						10
12	58,000	46,500	46,500					12
15	50,700	46,500	44,500	41,600				15
20	40,400	38,800	36,400	34,800	30,600			20
25	30,600	31,600	31,000	29,400	26,000	23,400		25
30		25,000	25,600	25,600	22,500	20,300	18,600	30
35		20,300	20,900	21,300	19,600	17,700	16,200	35
40		16,700	17,400	17,800	17,400	15,600	14,400	40
45			14,700	15,100	15,300	14,100	12,900	45
50			12,400	12,900	13,100	12,600	11,600	50
55				11,100	11,300	11,500	10,400	55
60				9,500	9,800	9,900	9,500	60
65					8,400	8,500	8,600	65
70					7,200	7,300	7,400	70
75					6,100	6,300	6,400	75
80						5,500	5,600	80
85						4,700	4,800	85
90							4,200	90
95							3,600	95
100							3,100	100

Notes to lifting capacity

Lifting capacities do not exceed 85% of tipping load. Weight of hook blocks and slings is part of the load, and is to be deducted from the capacity ratings. Consult operation manual for further details.

Note: Data published herein is intended as a guide only and shall not be construed to warrant applicability for lifting purposes. Crane operation is subject to the computer charts and operation manual both supplied with the crane.

RANGE DIAGRAM - MAIN BOOM

RT 345-1 XL

Outriggers Fully Retracted (0%)

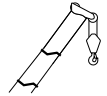

with hook block:
6 ft

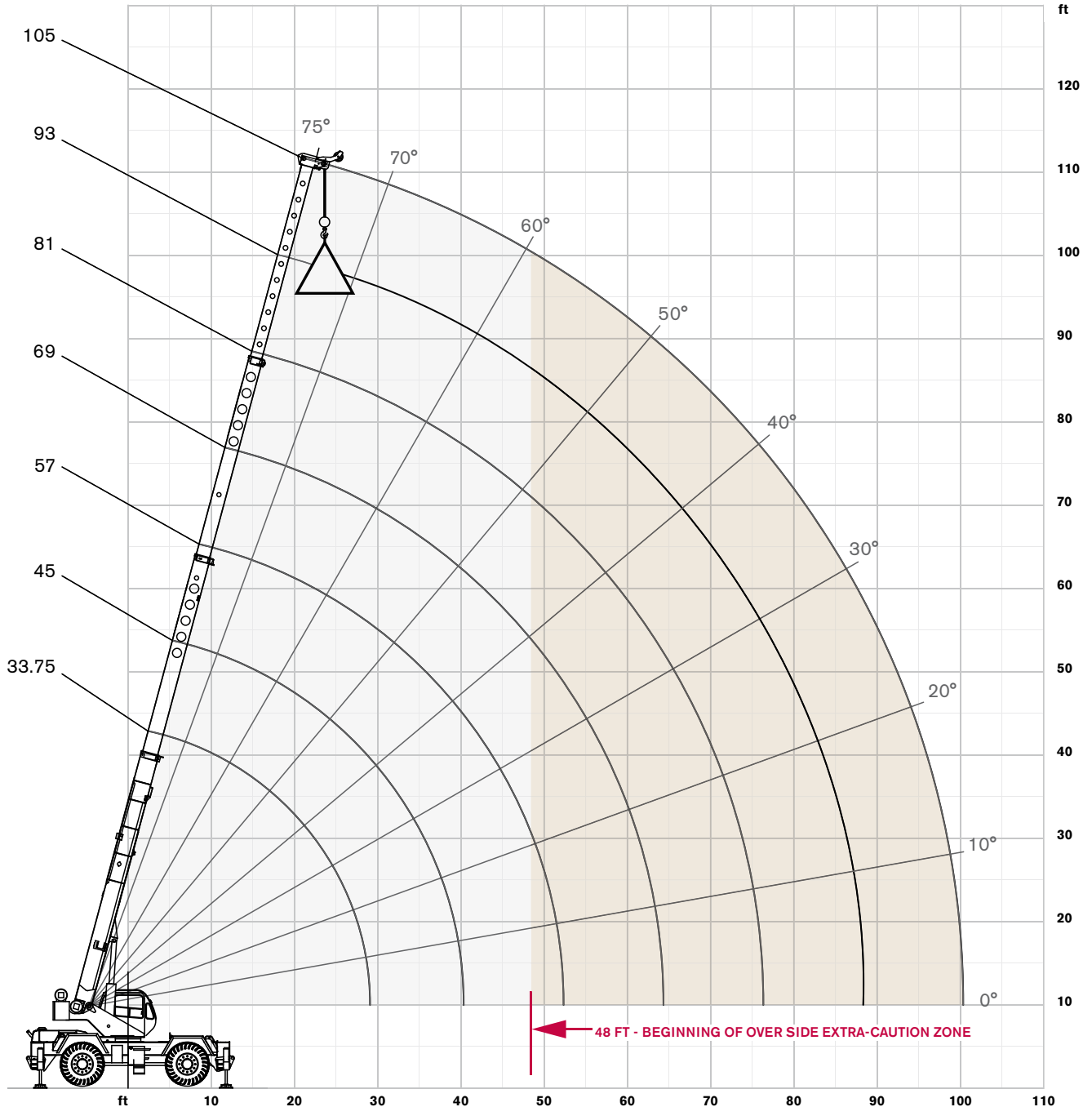



LOAD CHART- MAIN BOOM

RT 345-1 XL

Outriggers Fully Retracted (0%)

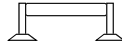
 13,000 lbs counterweight

 Outriggers retracted 9 ft 2 in (0%)

 360 degree rotation

Standard ASME B30.5

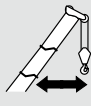
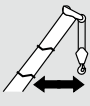
	Boom Length							
	33.75 ft	45 ft	57 ft	69 ft	81 ft	93 ft	105 ft	
ft	lb	lb	lb	lb	lb	lb	lb	ft
10	62,100	46,500						10
12	43,500	44,500	45,000					12
15	29,000	29,800	30,300	30,600				15
20	17,100	18,100	18,500	18,800	19,000			20
25	10,900	11,900	12,500	12,700	12,900	13,000		25
30		8,200	8,700	9,000	9,200	9,300	9,400	30
35		5,600	6,200	6,600	6,700	6,900	6,900	35
40		3,700	4,400	4,700	5,000	5,100	5,200	40
45		3,500	3,000	3,300	3,600	3,700	3,800	45
50			1,900	2,300	2,500	2,700	2,800	50
55				1,400	1,600	1,800	1,900	55
60						1,100	1,200	60

Notes to lifting capacity

Lifting capacities do not exceed 85% of tipping load. Weight of hook blocks and slings is part of the load, and is to be deducted from the capacity ratings. Consult operation manual for further details.

Note: Data published herein is intended as a guide only and shall not be construed to warrant applicability for lifting purposes. Crane operation is subject to the computer charts and operation manual both supplied with the crane.

RANGE DIAGRAM - MAIN BOOM

RT 345-1 XL

With Jib, 32 ft offset

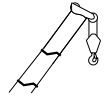

with hook block:
6 ft

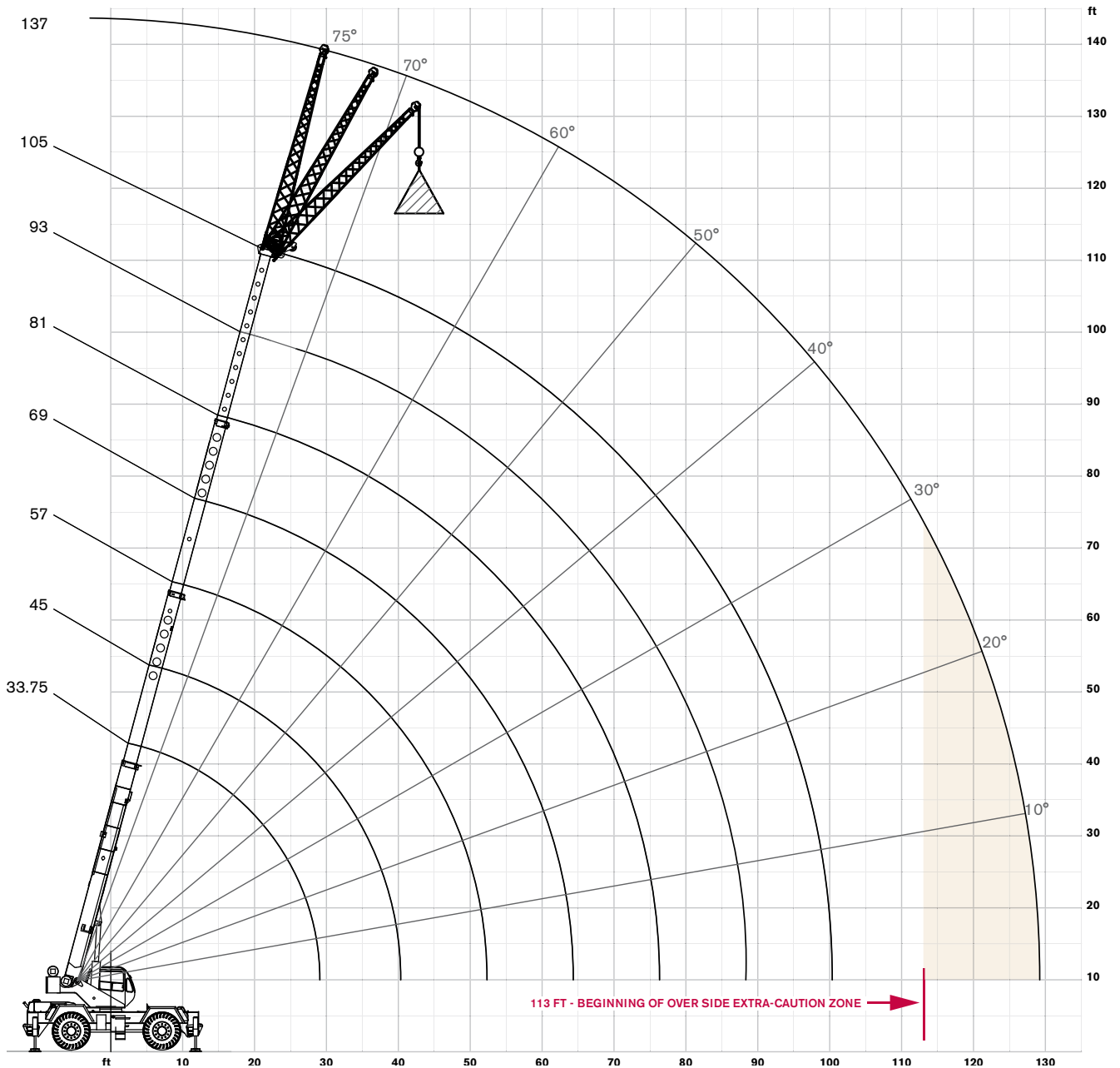



LOAD CHART- MAIN BOOM

RT 345-1 XL

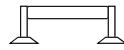

With Jib, 32 ft offset

 13,000 lbs counterweight

 Outriggers extended 22 ft (100%)

 360 degree rotation

Standard ASME B30.5

32 ft Offsettable Jib					
0° Offset		15° Offset		30° Offset	
 Radius (ft)	lbs	 Radius (ft)	lbs	 Radius (ft)	lbs
49	9,100	59	8,300	65	6,400
50	8,700	60	8,000	66	6,200
51	8,300	62	7,600	68	6,100
59	7,700	68	7,200	73	5,800
66	7,100	74	6,900	78	5,700
68	6,500	79	6,500	83	5,500
78	6,000	84	5,900	88	5,300
86	5,200	91	4,900	94	4,500
92	4,400	97	4,100	100	3,800
97	3,600	103	3,300	105	3,200
103	2,900	108	2,700	109	2,600
109	2,200	114	2,000	115	2,000
116	1,500	121	1,500	120	1,500
123	1,000	127	1,100	126	1,100

Notes to lifting capacity

Lifting capacities do not exceed 85% of tipping load. Weight of hook blocks and slings is part of the load, and is to be deducted from the capacity ratings. Consult operation manual for further details.

Note: Data published herein is intended as a guide only and shall not be construed to warrant applicability for lifting purposes. Crane operation is subject to the computer charts and operation manual both supplied with the crane.

RANGE DIAGRAM - MAIN BOOM

RT 345-1 XL

With Jib, 49 ft offset

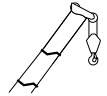

with hook block:
6 ft

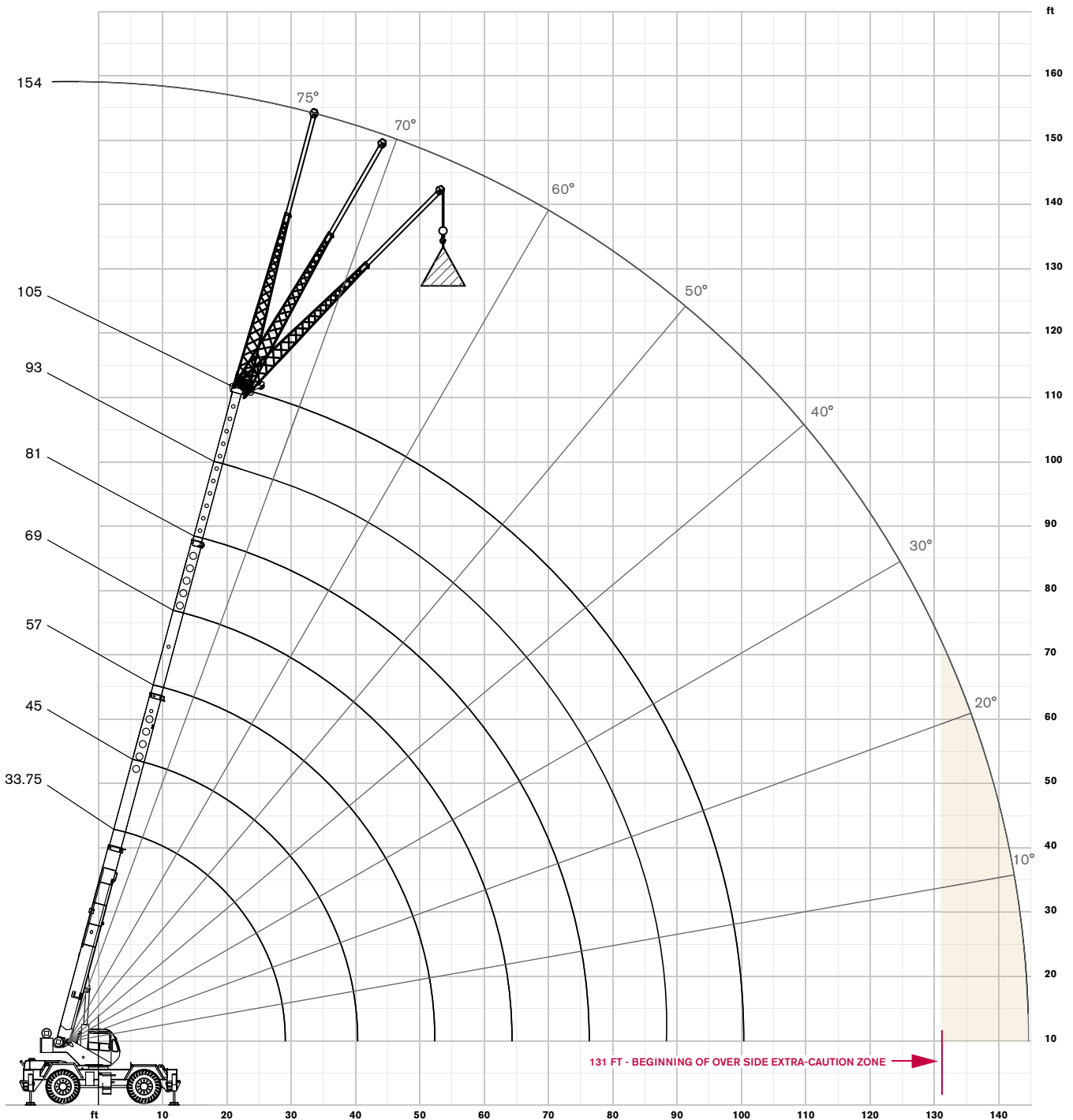



LOAD CHART- MAIN BOOM

RT 345-1 XL

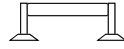

With Jib, 49 ft offset

 13,000 lbs counterweight

 Outriggers extended 22 ft (100%)

 360 degree rotation

Standard ASME B30.5

49 ft Offsettable Jib					
0° Offset		15° Offset		30° Offset	
 Radius (ft)	lbs	 Radius (ft)	lbs	 Radius (ft)	lbs
65	4,900	62	3,200	65	2,500
67	4,600	67	3,100	70	2,500
68	4,300	72	3,000	75	2,400
75	3,900	79	2,800	82	2,300
81	3,600	86	2,700	89	2,300
87	3,400	92	2,600	96	2,200
92	3,200	98	2,500	102	2,200
99	2,900	106	2,400	109	2,100
106	2,700	112	2,300	116	2,100
113	2,600	119	2,200	121	2,000
119	2,500	124	2,100	127	2,000
126	2,000	131	1,900	132	1,700
133	1,500	137	1,500	136	1,300
141	1,100	142	1,100	140	900

Notes to lifting capacity

Lifting capacities do not exceed 85% of tipping load. Weight of hook blocks and slings is part of the load, and is to be deducted from the capacity ratings. Consult operation manual for further details.

Note: Data published herein is intended as a guide only and shall not be construed to warrant applicability for lifting purposes. Crane operation is subject to the computer charts and operation manual both supplied with the crane.

RANGE DIAGRAM - MAIN BOOM

RT 345-1 XL

On Tires

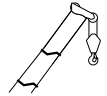

with hook block:
6 ft

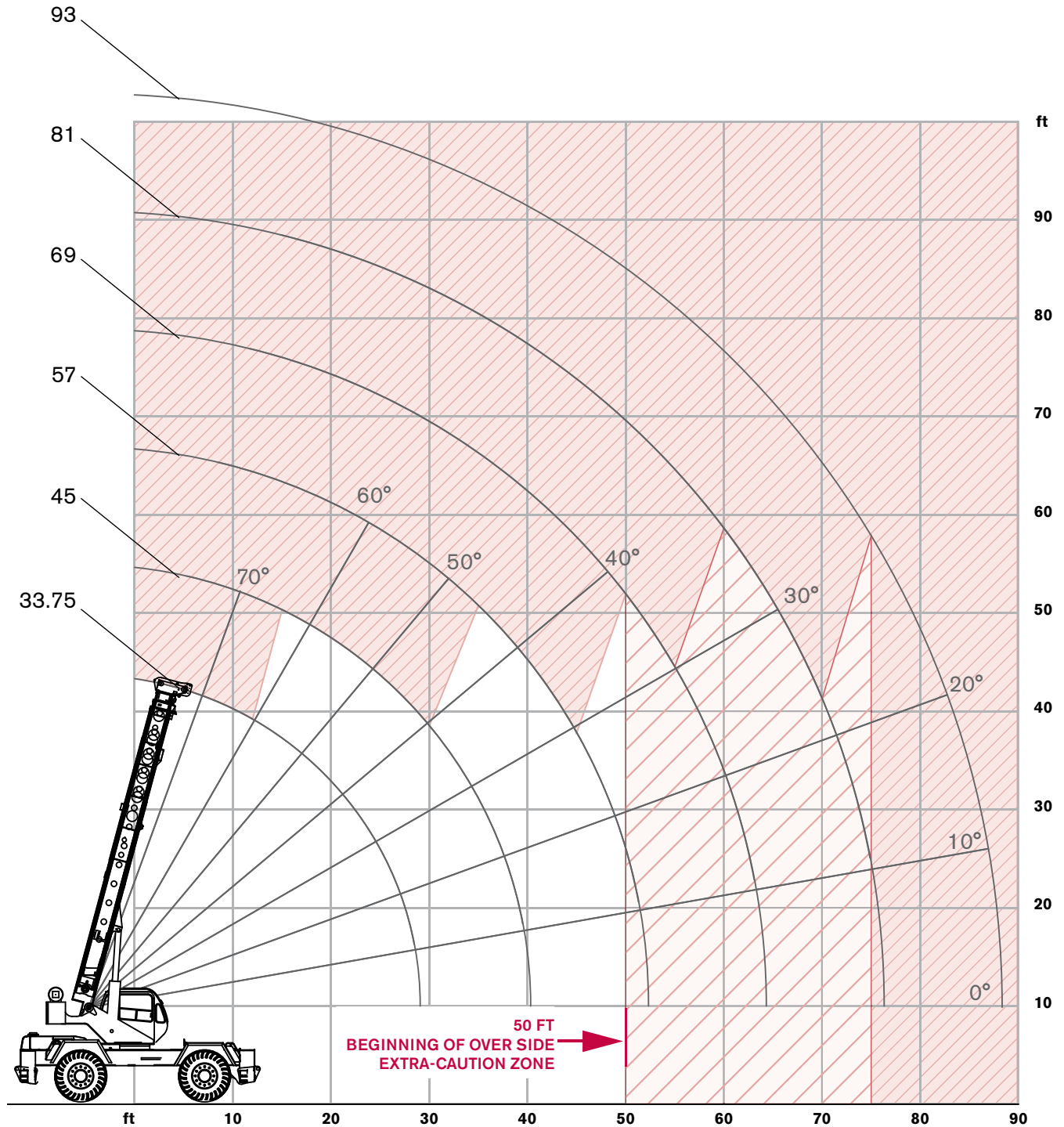



LOAD CHART- MAIN BOOM

RT 345-1 XL

On Tires

 13,000 lbs counterweight

 360 degree rotation

 On tires
26.5 x 25-26 PR

Standard ASME
B30.5

Boom		Travel Speed Boom straight over front		
Radius	Length	0 mph	Creep	2.5 mph
ft	ft	lb	lb	lb
10	33.75	64,500	48,600	40,600
12	33.75	56,200	42,100	33,300
15	45	46,800	34,800	28,700
20	45	30,300	26,400	21,500
25	45	20,300	20,300	16,500
30	45	14,600	14,600	12,900
35	57	11,200	11,200	10,700
40	57	8,700	8,700	8,700
45	57	7,000	7,000	7,000
50	69	5,700	5,700	5,700
55	69	4,600	4,600	4,600
60	81	3,800	3,800	3,800
65	81	2,900	2,900	2,900
70	81	2,100	2,100	2,100
75	93	1,300	1,300	1,300

Notes to lifting capacity









Lifting capacities do not exceed 75% of tipping load. Weight of hook blocks and slings is part of the load, and is to be deducted from the capacity ratings. Consult operation manual for further details.

Note: Data published herein is intended as a guide only and shall not be construed to warrant applicability for lifting purposes. Crane operation is subject to the computer charts and operation manual both supplied with the crane.



TECHNICAL DESCRIPTION

RT 345-1 XL

Boom

Standard configuration:	
	4 sections hydraulic actuated boom
	Full power mechanically synchronized
	Min. / Max. 33.75 ft / 105 ft
	Boom elevation angle range (min. / max.) -4° / 76°
Optional configuration:	
	Single sheave
	One section, side stowable Angular offsets 0, 15 and 30 degrees
	Two sections bi-fold, side stowable Angular offsets 0, 15 and 30 degrees
	With one section jib (max.) 140 ft
	With two section jib (max.) 158 ft

Hoist, Rope and Hook



Standard configuration:	
	Grooved drum Storage capacity 570 ft
	Two speed ratios
	Without load in 5th layer (low range / high range) 266 ft/min / 533 ft/min Without load in 1st layer (low range / high range) 184 ft/min / 369 ft/min
	6 x 19 IWRC XIPS, right regular lay, preformed
	5/8 in
	450 ft
	Max. line pull; 1st layer low-range 15,639 lb
	Max. line pull permissible 9,000 lb

TECHNICAL DESCRIPTION



RT 345-1 XL

Optional configuration:		
	2 sheaves	25 ton
	3 sheaves	30 ton
	4 sheaves	40 ton
	Grooved drum	
	Storage capacity	570 ft
	Without load in 5th layer (low range / high range)	266 ft/min / 533 ft/min
	Without load in 1st layer (low range / high range)	184 ft/min / 369 ft/min
	Rotation resistant compacted strand 18x19 or 19x19	
		5/8 in
		450 ft
	Minimum breaking strength	45,200 lbs
	Max. line pull permissible	9,000 lbs

Superstructure

Standard configuration:		
	Non stop	360°
	Maximum rotation speed without load	2.8 rpm
	Hydraulic motor	
	Planetary reducer	
	Manually actuated by foot pedal	360° house lock

Cab, Controls, Operator aids and Load limiter / Load indicator

Standard configuration:		
	Sliding door	
	Hinged, tinted all glass skylight	
	Six way adjustable seat	
	Armrest mounted dual axis electro-proportional joysticks	
	Steering wheel column with gear selector on the left and directional light selector on the right	
	Dashboard mounted switches for outrigger operation	
	Graphic interface for load indicator	

Optional configuration:



Hydraulic powered air conditioner
 Hydraulic powered heater
 Work lights
 Rotating beacon

Carrier, Engine, Drive-line and Hydraulic system

Standard configuration:



Hydraulic, independent extension:
 Diameter of outrigger pads
 Area of outrigger pads

24 in
 452 in²



Cummins QSB6.7 6 cylinders
 Rated power
 Maximum gross torque
 Intake: turbocharger with intercooler
 Fuel type
 Fuel tank capacity

160 hp @ 2,200 rpm
 540 ft-lb @ 1,400 rpm
 Diesel
 50 gallons



6 x 6 powershift transmission with torque converter
 Full time 4WD (Four-Wheel Drive)
 Rigid mounted front axle
 Oscillating rear axle
 Differential lock on front axle and rear axle
 Rear axle oscillation lock - manual or automatic actuation
 Air-over-hydraulic disc brakes
 Parking brake on front axle
 Hydraulic oil cooler on carrier



Hydraulic power steering
 Front wheel steering
 Four wheel steering concentric
 Four wheel steering crab
 Optional rear wheel steering package



Hydraulic Pumps:
Tandem pumps:
 Boom lift / Telescope
 Power steering / Outriggers and Swing
Single pump:
 Main and auxiliary hoist pump

38.5 gal/min @ 3,500 psi
 21 gal/min @ 2,500 psi
 59.5 gal/min @ 3,500 psi

Hydraulic oil reservoir capacity
 Hydraulic oil suction filter
 Hydraulic oil return filter

114 gallons
 250 microns
 5 microns

TECHNICAL DESCRIPTION

RT 345-1 XL

Vehicle performance

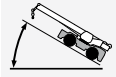

Max. in 1st gear
Max. in 6th gear

Standard configuration:

240%
5.2%



Max. (6th gear)

24.5 mph

Tires



Wide tread - Earth mover pattern (E3)

Standard configuration:

26.5 x 25 - 26PR

www.terexcranes.com

Effective Date: October 2010. Product specifications and prices are subject to change without notice or obligation. The photographs and/or drawings in this document are for illustrative purposes only. Refer to the appropriate Operator's Manual for instructions on the proper use of this equipment. Failure to follow the appropriate Operator's Manual when using our equipment or to otherwise act irresponsibly may result in serious injury or death. The only warranty applicable to our equipment is the standard written warranty applicable to the particular product and sale and Terex makes no other warranty, express or implied. Products and services listed may be trademarks, service marks or trade-names of Terex Corporation and/or its subsidiaries in the USA and other countries. All rights are reserved. Terex® is a registered trademark of Terex Corporation in the USA and many other countries. Copyright 2010 Terex Corporation.

Terex Cranes, Global Marketing, Dinglerstraße 24, 66482 Zweibrücken, Germany
Tel. +49 (0) 6332 830, Email: info.cranes@terex.com, www.terexcranes.com

Brochure Reference: TC-DS-I-E-RT 345-1 XL 10/10



WORKS FOR YOU.™