

P&H CENTURY 122

#83

22-ton Rough Terrain Crane

Handwritten signature

113-ft. (34.4m) maximum tip height

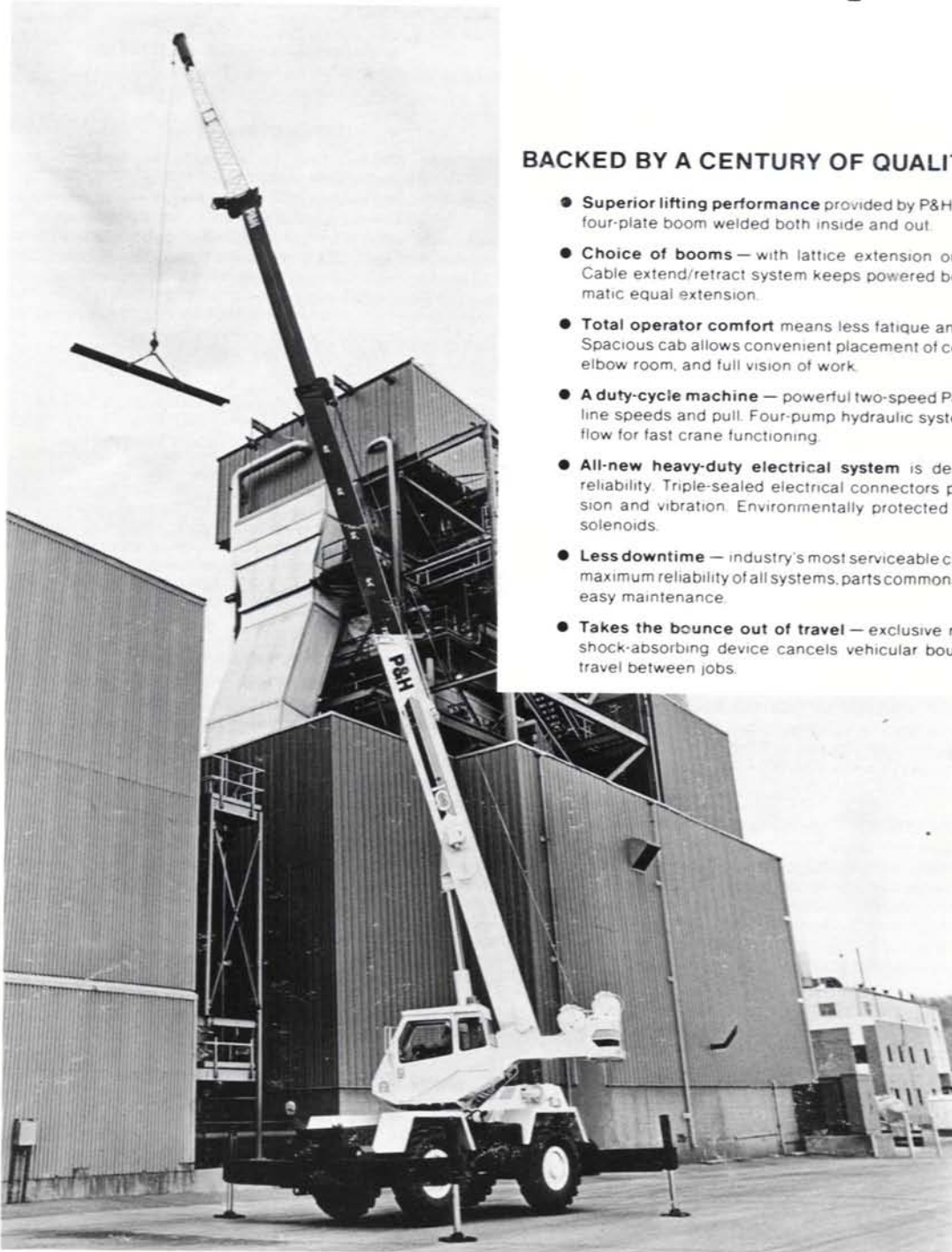

BACKED BY A CENTURY OF QUALITY & SERVICE

- **Superior lifting performance** provided by P&H rectangular full depth four-plate boom welded both inside and out.
- **Choice of booms** — with lattice extension or A-frame jib options. Cable extend/retract system keeps powered boom sections in automatic equal extension.
- **Total operator comfort** means less fatigue and greater production. Spacious cab allows convenient placement of controls, lots of leg and elbow room, and full vision of work.
- **A duty-cycle machine** — powerful two-speed P&H winches offer high line speeds and pull. Four-pump hydraulic system provides optimum flow for fast crane functioning.
- **All-new heavy-duty electrical system** is designed for maximum reliability. Triple-sealed electrical connectors protect against corrosion and vibration. Environmentally protected switches, relays and solenoids.
- **Less downtime** — industry's most serviceable crane is engineered for maximum reliability of all systems, parts commonality, accessibility and easy maintenance.
- **Takes the bounce out of travel** — exclusive new P&H Easy Ride™ shock-absorbing device cancels vehicular bouncing motion during travel between jobs.

Specifications

specifications

This P&H crane meets the requirements of ANSI B30.5(1982). Boom structure (boom, lattice extension and jib) has been tested per SAE J1063, machine stability tested per SAE J765. LOAD RATINGS shown apply only to machine as marketed by Harnischfeger Corporation.

BOOM



BOOM: All boom sections are of full depth rectangular four plate construction, welded inside and out, with adjustable slider pads on top, bottom and sides. All powered sections are single lever controlled. Block type semi-fixed telescope cylinder mounts provide ample capacity to telescope loads. Extension mechanism consists of one hydraulically powered cylinder with holding valve, which extends simultaneously, both the powered "first" section and the cable extended "second" section.

Boom point contains one idler sheave with bronze bushing and four load sheaves with roller bearings. Sheaves are 11.88" (301.7mm) pitch diameter.

STANDARD:

62' (18.90M) three (3) section powered boom, 25' (7.62M) retracted length, 62' (18.90M) extended length, consisting of one base section, one hydraulically powered "first" section, and one cable powered "second" section with boom point.

OPTIONAL:

72' (21.90M) three (3) section powered boom, 29' (8.8M) retracted length, 72' (21.90M) extended length, consisting of one base section, one hydraulically powered "first" section, and one cable powered "second" section with boom point.

CABLE EXTEND MECHANISM (72' BOOM): As the "first" section is extended, it pulls out the "second" section by a system of twin .875" (22mm) dia. extend cables and 15.75" (400mm) P.D. metallic sheaves with roller bearings. The extend cables are connected to a bracket on top of the base section, pass around the sheaves which are pinned to the front end of the "first" section, and then connected to a bracket at the rear end of the "second" section to equalize the load on the "extend ropes". The design safety factor is 3.5 to 1. As the powered "first" section is retracted it simultaneously pulls the cable extended "second" section back into the "first" section. The twin retract cables are .50" (13mm) dia. and are connected to brackets on the top of the base section, pass around the 10.31" (262mm) P.D. sheaves with bronze bushings that are pinned inside the rear end of the "first" section, and then connected to a bracket that is mounted inside the rear end of the "second" section.

CABLE EXTEND MECHANISM (OPTIONAL): Designed for use where higher wire rope safety factors (than 3.5 to 1) and larger sheave diameter to rope diameter ratios are required. Extend cables are 1.0" (26mm) dia.; extend sheaves are 23.0" (584mm) P.D. with roller bearings; design safety factor is 6 to 1.

25' (7.6M) LATTICE EXTENSION (OPTIONAL): Swing-around tapered lattice structure with single 13.1" (332.7mm) P.D. metallic point sheave with bronze bushing. Easily installed from ground level by pivoting from stored position on right side of boom base and pin connecting with self-storing pins to boom point. Offset 2' from boom. For extending reach of boom.

25'6" to 35'6" (7.8-10.8M) LATTICE EXTENSION (OPTIONAL): Swing-around tapered lattice structure with welded four-plate telescopic section and single 13.1" (332.7mm) P.D. metallic point sheave with bronze bushing. Easily installed from ground level by pivoting from stored position on right side of boom base and pin connecting with self-storing pins to boom point. Section is then extended or retracted and pinned with self-storing pins. Offset 2' from boom. For extending reach of boom.

EXTENSION OFFSET MECHANISM (OPTIONAL): Pivoting link which allows lattice extension to be offset to 22° from main boom.

JIB (OPTIONAL): 14'-6" (4.4M) underslung "A" frame structure with single 14.17" (360mm) P.D. metallic point sheave with bronze bushing. Easily installed from ground level by pivoting from its stored position or underside of boom base. Pin and pendant connected to boom point. Offset at 0', 10' and 20'. For extending reach of boom.

AUXILIARY SHEAVE (OPTIONAL): Single 13.1 (332.7mm) P.D. metallic sheave with bronze bushings, bracket-mounted on boom point. For use with SAE auxiliary winch line.

HOOK BLOCKS (OPTIONAL):

5 Ton — (4.5 metric ton) weighted hook with swivel and safety latch, for ½" (13mm) wire rope.
10 Ton — (9.1 metric ton) single sheave with swivel hook and safety latch, for ½" (13mm) wire rope.
15 Ton — (13.6 metric ton) 2 sheave with swivel hook and safety latch, for ½" (13mm) wire rope.
22 Ton — (20 metric ton) 3 sheave with swivel hook and safety latch, for ½" (13mm) wire rope.

COUNTERWEIGHTS:

For 62' boom w/o auxiliary hoist — 6,500 lbs. (2948 kg.)
w auxiliary hoist — 6,000 lbs. (2722 kg.)
For 72' boom w/o auxiliary hoist — 7,300 lbs. (3311 kg.)
w auxiliary hoist — 6,800 lbs. (3084 kg.)

UPPERSTRUCTURE



OPERATOR'S CAB: All-weather environmental cab of steel has hinged tinted ceiling window, slide-by right side window, locking slide-by door and large windows with full view in all directions. Safety glass used throughout. Operator's three-way adjustable seat has torsion suspension. Cab is 33.5 inches (850mm) wide with a stand-up height of 56 inches (1422mm) and is cushion-mounted for vibration dampening and noise reduction.

CAB EQUIPMENT (STANDARD): Cab contains all roading and crane function controls. Front console includes gauges for engine water temperature, engine oil pressure, transmission clutch pressure, transmission oil temperature, hydraulic oil temperature, air pressure, and fuel. Also includes hour meter, voltmeter, winch high speed indicators, anti-two-block warning indicator and dash light.

CAB ACCESSORIES (OPTIONAL): Heater (diesel or propane fueled, thermostatically controlled), defroster fan, air conditioner, electric horn, electric windshield wiper and washer, electric roof window wiper, seat belt, fire extinguisher, drum rotation indicators for main and auxiliary winches, vandal-proof glass (lexan), rotary roof beacon, rear view mirrors and engine condition warning system.



CONTROLS: In front of operator are foot pedals, for boom hoist, swing brake, service brakes, and engine throttle. Left of steering wheel are console mounted double-acting levers for swing and telescope. At the right are levers for auxiliary winch (optional), main winch and boom hoist. Drum rotation indicators (optional) are mounted on auxiliary and main winch levers and an optional directional indicator (emergency flasher) switch on steering column. At operator's front console are mounted switches for optional starting aid, master ignition, engine start, optional windshield wiper, optional master lights. At operator's right are console mounted switches for emergency/parking brake, defroster (optional), hi-low transmission range, steering mode selection and outrigger controls, circular level, gear range selector switch, forward-reverse selector lever, hand throttle, swing brake lever, travel stabilizer switch and house lock lever. Console has prewired, removable modules for ease of service.



MAIN WINCH: P&H Model 1080 two speed, mounted on rear of upper frame. Planetary gearing with equal speed power raising and lowering. Infinitely variable controlled speed. Spring applied, hydraulically released load holding multiple disc brake is automatic. Complete with 425' (130m) wire rope.

Drum: 10.75" (273mm) P.D. X 16.5" (419mm) wide with 16.75" (425mm) dia. flanges.

Wire Rope: ½" (13mm) dia. 6 X 25 extra improved plow steel, with 7 X 7 I.W.R.C.

Optional: ½" (13mm) dia. 8 X 19 spin resistant extra improved plow steel, with 7 X 7 I.W.R.C.

Drum Capacity: 543 ft. (165m) 5 layers.

Line Pull (Max): 10,263 lb. (4,655 kg) 1st layer.

Line Pull (Permissible - Based on Strength of Wire Rope):
7600 lbs. (3454 kg) 6 X 25 cable
6680 lbs. (3036 kg) 8 X 19 spin resistant cable

Line Speed Up (Max): 404 fpm (123m/m) 5th layer.

AUXILIARY WINCH (OPTIONAL): Same as main winch. Mounted on rear of revolving frame. Complete with 360' (110m) wire rope and additional boom point idler sheave.



BOOM HOIST: One 9.84"(250mm) bore X 58.0" stroke cylinder, double-acting. Hydraulically powered raising and lowering with holding valve. Cylinder has internal accumulator providing a stabilizing "Easy Ride" when roading machines. Stabilizer is controlled from operator's cab. Boom hoist cylinder less "Easy Ride" is optional.

BOOM TELESCOPE: One 5.9"(150mm) I.D. cylinder — double acting for powered section. Hydraulically powered extending and retracting with holding valve.

HYDRAULIC SYSTEM: System utilizes two tandem gear type pumps. One tandem pump operating at 2650 rpm, provides 45 gpm (170 lpm) to the main and/or auxiliary winches and 45 gpm (170 lpm) to the boom hoist and boom telescope cylinders. A second tandem pump operating at 2650 rpm, provides 29 gpm (110 lpm) to the swing circuit and 29 gpm (110 lpm) for the steering, winch boost and outrigger circuits. Total flow at 2650 engine rpm is 148 gpm (560 lpm). From this flow, all but 44 gpm (167 lpm) is filtered to 10 microns on return to the reservoir. Maximum pressure drop of return filter with clean element and oil at normal operating temperature is 25% of bypass setting to assure minimum fluid resistance and power loss while protecting seals in cylinders, valves and motors.

The 90 gal.(340 liter) reservoir is located on left side of carrier. Pumps, valves, cylinders and motors are readily accessible and easy to service. Control valves are four-way, three position type with low effort spools and pilot-operated relief valves for quick, smooth response. Swing circuit has pressure compensated valve for swing metering control. Cable linkage connects valve to control levers. Hydraulic oil cooler is standard.



SWING UNIT: Hydraulic motor driving through gear reducer to pinion gear, 360° continuous rotation to 3.9 RPM.

SWING GEAR: External cut spur gear 39.667" (100.75 cm) P.D. Ring gear dust cover is available (optional).

SWING BRAKE: Spring applied, hydraulically released, dry disc brake, integral with swing reducer. Hand brake control lever mounted on side console. A manual foot pedal applies brake for static holding.

HOUSE LOCK: Single position (front) pin-in-hole lock manually engaged with house lock lever. A positive 360° position lock is available (optional).

FASTENING TO LOWER: Single row ball bearing integral with swing gear. Welded to carrier frame and bolted to rotating frame. Bearing is protected from dust by labyrinth seal.

ROTARY MANIFOLD: Sealed rotary swivel or air and hydraulic hose connections between rotating upper and carrier. Quickly removable from above or below for servicing. Electrical swivel is mounted on top of air and hydraulic swivel.

CARRIER



CARRIER:
4X4X4 (Four wheels drive. Four wheels steer)
— For rough terrain with limited turning area.

FRAME: All-welded unitized construction assures rigidity and permanent alignment of swing bearing and rotating upper machinery. Fabricated of rectangular structural tubing main frame beams of high strength 45,500 psi (3200 kg/cm²) minimum yield steel and reinforced with rectangular box cross members of high strength 47,000 psi (3300 kg/cm²) minimum yield steel.

SHEAVE AND DRUM TO WIRE ROPE RATIOS: (Pitch Diameter)

	Sheave to Wire Rope	Drum to Wire Rope
Boom Main Sheave	23.8 to 1	— —
Boom Idler Sheave	23.8 to 1	— —
Boom Extension Sheave	23.8 to 1	— —
Jib Sheave	23.8 to 1	— —
Main Winch	— —	19.3 to 1
Aux. Winch	— —	19.3 to 1
Cable Extend Sheave	18:1	(Domestic)
Cable Retract Sheave	23:1	
Cable Extend Sheave	23:1	(Export)



HYDRAULIC OUTRIGGERS: Four (4) independent assemblies that hydraulically extend out horizontally from carrier frame and down vertically to form a stable working platform. Four (4) double acting hydraulic cylinders provide independent horizontal beam movement and four (4) provide vertical rod movement. Vertical cylinders are equipped with holding valves. Cylinders are actuated by electric solenoid directional control valves operated from cab console switches. Beams are rectangular box members fabricated of high strength 79,600 psi (5600 kg/cm²) minimum yield steel. Four (4) fabricated 14" (35.6cm) sq. floats are removable and stored on frame. Extended spread is 18'-0" (5.4m) from C/L to C/L of vertical cylinders. Retracted within carrier width of 8'-0" (2.44m).



STEERING OPTIONS: A) Front axle steer — pressure compensated hydrostatic power system fully controlled by steering wheel B) Front and rear axle steer — pressure compensated hydrostatic power system fully controlled by steering wheel for front and rear axles.

Two wheel, four wheel and crab steering mode selection is controlled by 3 position sealed switch located in cab on side console. Center position of switch locks position of rear wheels and only front wheels are steerable. The amount of rear wheel turn is controlled by steering wheel.

FRONT AXLE: Steer and drive or non-drive axle driven through differential with planetary in hubs. Axle is rigid mounted with power steering.

REAR AXLE: Steer and drive axle driven through differential with planetary in hubs. Power steering, with optional no-spin differential. Axle is pivot-mounted with automatic hydraulic lockout cylinders to prevent oscillation (vertical movement of axle). Total oscillation attainable is 8 in. (20.3cm).

SERVICE BRAKES: Air over hydraulic brakes on all 4 wheels, internal expanding shoe type, actuated by foot pedal in cab.

PARKING BRAKE: Spring-set air chamber on drum brake on output yoke of transmission. Spring set and air release.

TIRES: Standard — 16:00X24-16 PR tubeless (G-2)
Optional — 14:00X24-20 PR tube type (ML-3)
16:00X25-24 PR tubeless (E-3)
17:50X25-20 PR tubeless(L-2)
20.5X25-20 PR tubeless, wide base (E-2)
20.5X25-20 PR tubeless, wide base (E-3)

MISCELLANEOUS EQUIPMENT (STANDARD): Sliding engine hood, tow lugs, hydraulic pump disconnect, automatic moisture ejector for air system, oil to air transmission cooler, front axle disconnect and oil to air hydraulic oil cooler.

MISCELLANEOUS EQUIPMENT (OPTIONAL): Sheet metal cover for control valves, boom angle indicator, boom length indicator, load moment device, engine starting aid, fenders, pintle hooks, optional spare wheel and tire, rear steer centering indicator, tire inflation kit, axle lockout with override, storage compartment, cable spooling device, tachometer, speedometer, headlights, taillights, directional lights, emergency flashers, floodlights, large rear view mirrors, alcohol evaporator, air dryer, plumbing and controls for aux. winch, front bumper tow winch, electric back-up alarm, engine condition warning system and sound reduction package.

**POWER PLANT:**

ENGINE:	STANDARD	OPTIONAL
Make	Detroit Diesel	Cummins
Model	V-8.2L	6BT5.9
Type	Diesel	Diesel
No. of Cylinders	8	6
BoreXStroke		
In.	4.25X4.41	4.02X4.72
mm	108X112	102X120
Displacement,		
In. ³	500	359
Liters	8.2	5.88
Cycles	Four	Four
Air Induction	Nat. Aspirated	Turbocharged
Starting	24 volt motor negative ground	24 volt motor negative ground
Charging	24 volt alternator, 35 amp	24 volt alternator, 35 amp
Compressor, air	12 CFM @ 1250 RPM	9.5 CFM @ 1250 RPM
Governor, air	100-120 PSI	100-120 PSI
Fan	6 Blade suction type	6 Blade suction type
	22 in. (559mm)	22 in. (559mm)

RATINGS:

Gross HP @

RPM	128 @ 2650	130 @ 2650
Kilowatts	95.5 @ 2650	97 @ 2650

TRANSMISSION:

STANDARD

OPTIONAL

Powershift with high/low range. Fully electric gear shift, 6 speeds equal forward and reverse, with high-low, electric controlled air range shift. Electrically controlled, air generated front axle disconnect for highway travel.

Sequential Powershift 6 speeds forward, 3 speeds reverse, electrically controlled and operated gear shift. Neutral safety start. Electrically controlled hydraulically operated front axle disconnect for highway travel.

ACCESSORIES:

Cooling Radiator	Liquid recirculating, bypass, pressurized. Tube and fin type, thermostat controlled, with sealed baffle, rapid warm-up.
Starting	Cold weather starting aid (measured shot) required below 30° F (-1 C).
Electrical System	System is 24 volt, negative ground. Wire harnesses have protective braided nylon covering and are individually clamped to framework. Environmentally-sealed toggle-type switches and harness connectors are used.
Battery	Reserve capacity 239 minutes. Cold cranking amps at 0° F - 669 amps.
Fuel Tank	52.8 gal. Meets FHWA requirements, (right side between tires).
Air Cleaner	Single stage dry — replaceable element.
Lube Oil Filter	Replaceable element. Full-flow.
Fuel Filter	Spin-on Replaceable element.



PERFORMANCE: Standard Power shift transmission — six (6) forward speeds, 6 reverse speeds. Performance in highest and lowest gear based on engine at full load rpm, 43,387 lb. gross vehicle weight, 16:00 X 24 tires, 62' boom, 6500 lb. counterweight and good surface road Maximum grade at 1 mph is approximately 53%.

Low Range Speeds

1st	3.4 mph (5.4 Kmph)
2nd	7.3 mph (11.7 Kmph)
3rd	13.9 mph (22.4 Kmph)

High Range Speeds

1st	7.6 mph (12.2 Kmph)
2nd	16.1 mph (25.9 Kmph)
3rd	28.9 mph (46.6 Kmph)

weights

1. STANDARD BASIC MACHINE INCLUDES:

- A. BASIC CARRIER WITH HYD. OUTRIGGERS, SLEWING RIM, FULL FUEL AND HYD. TANKS AND SHEETMETAL INCLUDING SLIDING ENGINE HOOD FRONT COVERS & FENDERS
- B. BASIC UPPER WITH CAB AND CONTROL INSTALLATIONS, SINGLE POSITION HOUSE LOCK, BASIC ANTI 2-BLOCK, SEAT, AND SWIVEL INSTALLATION.
- C. STANDARD OPTIONS AS FOLLOWS:
 1. 62 FT. CABLE EXTEND BOOM INST. WITH 28 TON (4 SHEAVE NO JIB) SHEAVE INSTALLATION.
 2. 6500 LB. COUNTERWEIGHT INSTALLATION 62 FT. BOOM W/O AUX. WINCH).
 3. MAIN WINCH INSTALLATION.
 4. MAIN WINCH ROPE (50 DIA. - 425 FT.)
 5. 8.2 L ENGINE WITH RANGE/SHIFT TRANSMISSION.
 6. 4 x 4 STANDARD PLANETARY AXLES.
 7. 16:00 x 24 E-2 TIRES
 8. UPPER VALVE COVER INSTALLATION
 9. FENDER INSTALLATION
 10. AXLE LOCKOUT INSTALLATION
 11. ROADING STABILIZER INSTALLATION

2. ADJUSTMENTS FOR OPTIONS:

- A. IF AN OPTIONAL ITEM HAS BEEN SELECTED IN PLACE OF A STANDARD OPTION. THE WEIGHT ADJUSTMENT IS THE DIFFERENCE BETWEEN THE TWO ITEMS. THE WEIGHT ADJUSTMENT IS ADDED OR SUBTRACTED FROM THE STANDARD. BASIC MACHINE WEIGHT AS INDICATED BY THE SIGN (+) OR (-).

3. ADDITIONS FOR OPTIONS:

- A. IF AN OPTIONAL ITEM SELECTED IS AN ADDITION ITEM ON THE MACHINE (NOT REPLACING A STANDARD OPTION), THEN THE WEIGHT ADJUSTMENT IS THE TOTAL WEIGHT OF THE OPTION, AND IS ADDED TO THE STANDARD BASIC MACHINE WEIGHT AS PREVIOUSLY INDICATED.

VEHICLE WEIGHTS:

	POUNDS			KILOGRAMS		
	GROSS	FRONT	REAR	GROSS	FRONT	REAR
BASIC CARRIER	13,050	6,325	6,725	5,925	2,872	3,053
BASIC UPPER	5,132	1,977	3,155	2,330	897	1,433
STANDARD OPTIONS:						
62 FT. BOOM INST.	8,072	9,522	-1,450	3,665	4,323	-658
ROADING STABILIZER INST.	1,201	712	489	545	323	222
6500 LB. COUNTERWEIGHT INST.	6,501	-2,709	9,210	2,952	-1,230	4,182
MAIN WINCH INST.	614	-89	703	279	-40	319
MAIN WINCH ROPE	196	-47	243	89	-21	110
VALVE COVER INST.	97	47	50	44	21	23
FENDER INST.	470	235	235	214	107	107
DDA 8.2L ENG. W/R-SHIFT TRANS.	2,852	130	2,722	1,295	59	1,236
16.00 X 24 E-2 TIRE INST.	2,092	1,046	1,046	950	475	475
FRONT AXLE INST. (STD.)	1,612	1,616	-4	732	734	-2
REAR AXLE INST. (STD.)	2,183	-37	2,220	991	-17	1,008
AXLE LOCKOUT INSTALLATION	15	4	11	7	2	5
BASIC MACHINE	44,087	18,732	25,355	20,018	8,505	11,513
ADJUSTMENT FOR OPTIONS:						
BOOM OPTIONS: (US & EUR. BOOMS)						
72 FT. BOOM INST.	981	2,686	-1,887	445	1,302	-857
STD. HOIST CYL. INST.	-172	-95	-77	-78	-43	-35
POWER PLANT OPTIONS:						
DDA 8.2L ENG. W/P-SHIFT TRANS.	87	17	70	40	8	32
6BT5.9 W/R-SHIFT TRANS.	-420	-5	-415	-191	-3	-188
6BT5.9 W/P-SHIFT TRANS.	-318	17	-335	-145	7	-152
6D14T W/R-SHIFT TRANS.	-109	-55	-54	-50	-25	-25
6D14T W/P-SHIFT TRANS.	-30	-28	-2	-14	-13	-1
REAR AXLE INST. (NO-SPIN)	20	0	20	9	0	9
TIRE OPTIONS:						
14.00 X 24 TIRE INST.	-158	-79	-79	-72	-36	-36
16.00 X 25 TIRE INST.	1,186	593	593	538	269	269
20.5 X 25 E-2 TIRE INST.	1,476	738	738	670	335	335
20.5 X 25 E-3 TIRE INST.	1,844	922	922	836	418	418
MAIN & AUX WINCH INST. (W/O ROPE)	560	-180	740	254	-82	336
STORAGE BOX INST.	75	87	-12	34	40	-6
COUNTERWEIGHTS:						
6000 LB. CWGT. FOR-	-500	208	-708	-227	95	-322
62 FT. BOOM WITH AUX. WINCH						
6800 LB. CWGT. INST. FOR-	300	-125	425	136	-57	193
72 FT. BOOM WITH AUX. WINCH						
7300 LB. CWGT. INST. FOR-	800	-333	1,133	363	-151	514
72 FT. BOOM WITHOUT AUX. WINCH						
ADDITIONS FOR OPTIONS:						
FRONT MOUNT WINCH INST.	338	534	-196	154	242	-88
FLOODLIGHT INST.	36	37	-1	16	17	-1
PINTLE HOOK INST. (FRONT)	34	52	-18	15	23	-8
PINTLE HOOK INST. (REAR)	34	-18	52	15	-8	23
DIESEL HEATER INST.	44	9	35	20	4	16
PROPANE HEATER INST.	52	10	42	23	4	19
AIR DRIER INST.	23	-7	30	10	-3	13
AUX WINCH ROPE (360' .50 DIA)	166	-73	239	75	-33	108
72 FOOT BOOM ATTACHMENTS						
AUX. SHEAVE INST.	91	277	-186	41	126	-85
25 FT. EXTENSION INST.	816	1,321	-505	370	600	-230
25-35 FT. EXTENSION INST.	1,214	1,739	-525	551	790	-239
A-FRAME JIB	546	1,144	-600	248	519	-271
10 TON 1SHEAVE	325	953	-628	148	433	-285
15 TON 2SHEAVE	336	986	-650	153	447	-294
22 TON 3SHEAVE	354	1,038	-684	161	471	-310
5 TON HOOK	121	361	-240	55	164	-109
62 FOOT BOOM ATTACHMENTS						
AUX. SHEAVE INST.	91	241	-150	41	109	-68
25 FT. EXTENSION INST.	816	994	-178	370	452	-82
25-35 FT. EXTENSION INST.	1,214	1,253	-39	551	569	-18
A-FRAME JIB	546	926	-380	248	420	-172
10 TON 1SHEAVE	325	823	-498	148	374	-226
15 TON 2SHEAVE	336	851	-515	153	386	-233
22 TON 3SHEAVE	354	897	-543	161	407	-246
5 TON HOOK	121	313	-192	55	142	-87

areas of operation

ON OUTRIGGERS

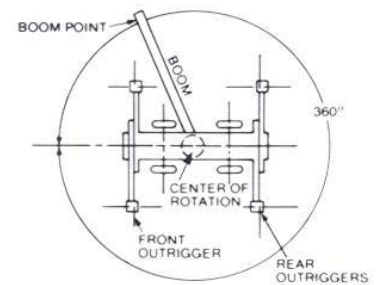

ON TIRES

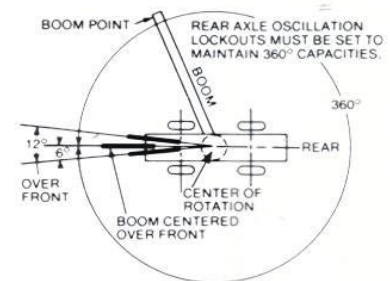

3105J67

62 foot — three section powered boom

rated crane loads in pounds —

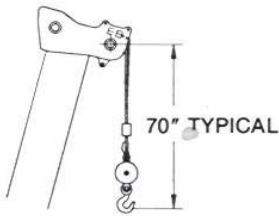

DIMENSIONS TYPICAL FOR ALL ATTACHMENTS

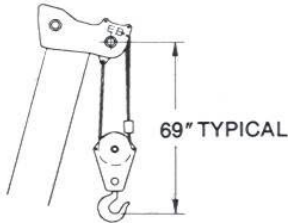

OPERATING RADIUS FT.	POWERED BOOM LOAD RATINGS IN POUNDS WITH OUTRIGGERS EXTENDED												OPERATING RADIUS FT.	
	POWERED BOOM LENGTH													
	25 FT. 360°	30 FT. 360°	38 FT. 360°	46 FT. 360°	54 FT. 360°	62 FT. 360°	SEE DEDUCTIONS CHART							
10	57	44000	64	41400	70	38700	74	38000						10
12	52	40300	59	40300	67	38300	72	36300						12
15	41	33500	52	33500	62	33300	67	31500	72	30000	74	28500	15	
20			37	24900	52	24900	60	24900	66	24600	70	23400	20	
25					41	19200	53	19200	60	19200	64	19200	25	
30					26	15000	44	15000	53	15000	59	15000	30	
35							33	11500	45	11500	53	11500	35	
40							14	9100	37	9100	47	9100	40	
45									25	7400	39	7400	45	
50											30	6100	50	
55											17	5100	55	
60													60	
65													65	

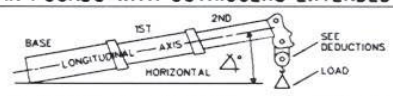

INFORMATION:

1. CRANE LOAD RATINGS DO NOT EXCEED 85% OF TIPPING.
2. RATINGS ABOVE THE HEAVY LINE ARE BASED ON THE MACHINE'S HYDRAULIC OR STRUCTURAL COMPETENCE AND NOT ON MACHINE STABILITY.
3. DEDUCTIONS MUST BE MADE FROM RATED LOADS FOR STOWED LATTICE EXTENSION, OPTIONAL ATTACHMENTS, HOOKS AND HOOKBLOCKS (SEE DEDUCTIONS CHART). WEIGHTS OF SLINGS AND ALL OTHER LOAD HANDLING DEVICES SHALL BE CONSIDERED A PART OF THE LOAD.
4. CRANE LOAD RATINGS WITH OUTRIGGERS ARE BASED ON OUTRIGGERS FULLY EXTENDED AND SET TO A DISTANCE OF 9 FEET FROM THE LONGITUDINAL AXIS OF THE CARRIER TO THE OUTRIGGER FLOAT PIVOT CONNECTION WITH ALL LOAD REMOVED FROM CARRIER WHEELS.

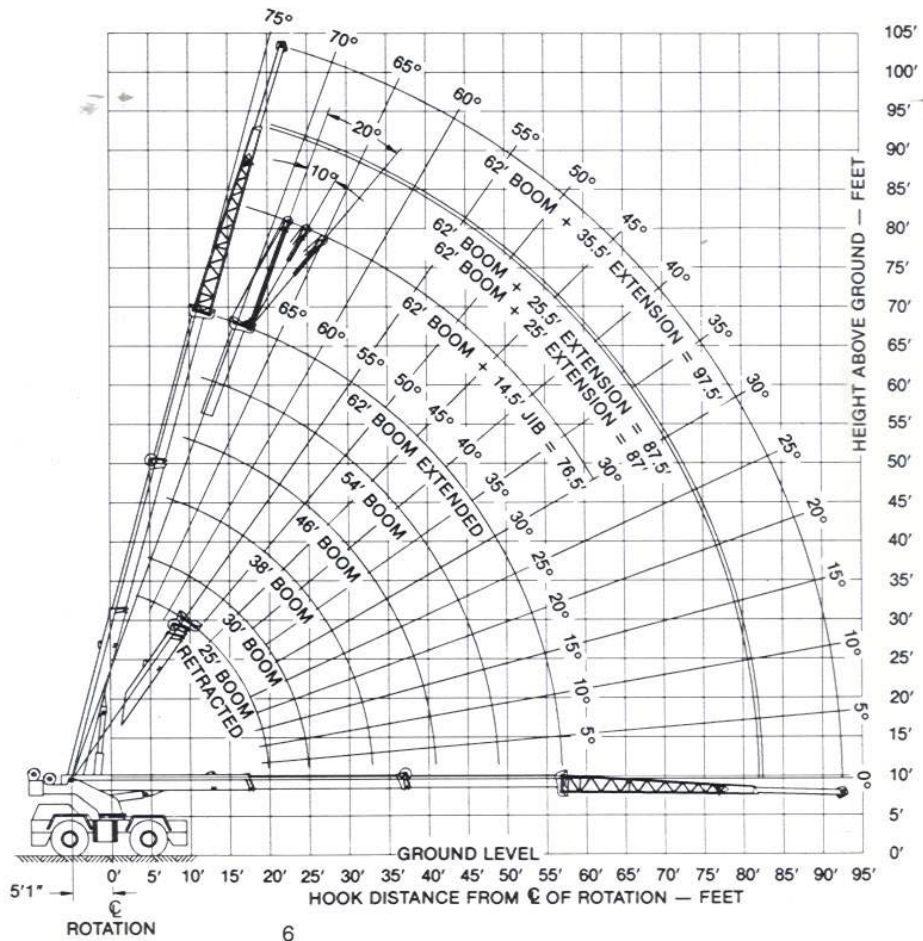
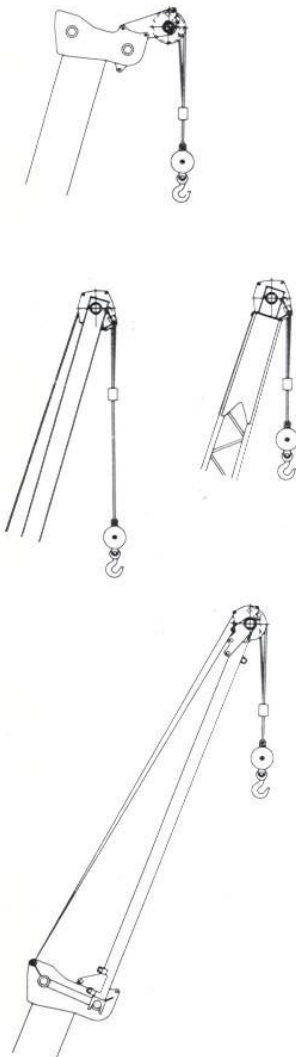

"with outriggers fully extended and set"

PCSA CLASS 10-91

boom in 360° work areas

OMEGA 122-22 TON

LATTICE EXTENSION LOAD RATINGS IN POUNDS WITH OUTRIGGERS EXTENDED											
OPERATING RADIUS	25 FT. LATTICE EXTENSION			OPERATING RADIUS	25.5-35.5 FT. LATTICE EXTENSION RETRACTED			OPERATING RADIUS	25.5-35.5 FT. LATTICE EXTENSION EXTENDED		
	FOR ALL BOOM LENGTHS UP TO 87 FT.				FOR ALL BOOM LENGTHS UP TO 87.5 FT.				FOR ALL BOOM LENGTHS UP TO 97.5 FT.		
	Δ°	RATED LOAD IN POUNDS			Δ°	RATED LOAD IN POUNDS			Δ°	RATED LOAD IN POUNDS	
FOR 87 FT. BOOM ONLY		360°			360°			360°			
25	73	13000		25	73	13000		25			
30	70	12400		30	70	12000		30	73		
35	66	11100		35	66	10700		35	70		
40	62	9700		40	63	9500		40	66		
45	58	8000		45	59	7700		45	63		
50	54	6700		50	55	6400		50	60		
55	50	5700		55	50	5400		55	56		
60	45	4900		60	45	4600		60	52		
65	40	4200		65	40	3900		65	48		
70	34	3600		70	34	3300		70	44		
75	26	3100		75	27	2800		75	39		
80	15	2700		80	17	2400		80	33		
85				85				85	26		
90				90				90	17		
								95			
								100			

NOTE:
 1. WHEN BOOM IS NOT FULLY EXTENDED, USE ONLY BOOM ANGLES TO DETERMINE LOAD RATING.
 2. FOR BOOM ANGLES NOT SHOWN, USE RATING OF NEXT LOWER BOOM ANGLE.

MAXIMUM JIB LOAD RATINGS IN POUNDS WITH OUTRIGGERS EXTENDED			
MIN. BOOM ANGLE	JIB ANGLE		
	0°	10°	20°
75°	13000	11500	9700
70°	12500	10700	8600
65°	11500	9800	7900
60°	9900	8900	7400
55°	7900	7500	6900
50°	6500	6200	6000
45°	5500	5300	5200
40°	4800	4700	4600
35°	4200	4100	4100
30°	3800	3800	3700

JIB CAPACITY NOTES:
 1. JIB LOAD RATINGS ABOVE HEAVY LINE ARE BASED ON STRUCTURAL COMPETENCE OF THE MACHINE. RATINGS BELOW HEAVY LINE ARE BASED ON STABILITY OF THE MACHINE AND DO NOT EXCEED 85% OF TIPPING LOAD WITH FULLY EXTENDED OUTRIGGERS. USE OF OUTRIGGERS IS REQUIRED WHEN BOOM IS EQUIPPED WITH JIB.
 2. FOR BUCKET RATINGS ON JIB, DEDUCT 20% FROM MAXIMUM JIB LOAD RATINGS.
 3. WARNING: DO NOT LIFT WITH JIB AT BOOM ANGLES BELOW 30°. LOSS OF STABILITY OCCURS RAPIDLY.

MAIN & AUXILIARY HOIST REEVING 6 X 25									
1/2 DIA. WIRE ROPE BREAKING STRENGTH 26,600 LBS.									
PART OF LINE	1	2	3	4	5	6	7	8	9
MAXIMUM LOAD	7600	15200	22800	30400	38000	44000			

MAIN & AUXILIARY HOIST REEVING 8 X 19									
1/2 DIA. WIRE ROPE BREAKING STRENGTH 23,400 LBS.									
PART OF LINE	1	2	3	4	5	6	7	8	9
MAXIMUM LOAD	6680	13350	20000	26700	33400	40000	44000		

WARNINGS:

- LOADED BOOM ANGLES AT SPECIFIED BOOM LENGTHS GIVE ONLY AN APPROXIMATION OF THE OPERATING RADIUS. THE BOOM ANGLE BEFORE LOADING SHOULD BE GREATER TO ACCOUNT FOR DEFLECTIONS. DO NOT EXCEED THE OPERATING RADIUS FOR RATED LOADS.
- POSITIONING OR OPERATION OF POWERED BOOM LENGTHS AT RADII BEYOND THE MAXIMUMS OR MINIMUMS SHOWN, IS NOT INTENDED OR APPROVED.
- POSITIONING OR OPERATION OF LATTICE EXTENSIONS OR JIB AT BOOM ANGLES BEYOND THE MAXIMUMS OR MINIMUMS SHOWN, IS NOT INTENDED OR APPROVED.
- FOR POWERED BOOM LENGTHS NOT SHOWN, USE RATING OF NEXT LONGER POWERED BOOM. FOR LOAD RADII NOT SHOWN, USE RATING OF NEXT LONGER RADIUS.
- CRANE LOAD RATINGS ON OUTRIGGERS ARE BASED ON FREELY SUSPENDED LOADS WITH THE MACHINE LEVELED AND STANDING ON A FIRM UNIFORM SUPPORTING SURFACE. NO ATTEMPT SHALL BE MADE TO MOVE A LOAD HORIZONTALLY ON THE GROUND IN ANY DIRECTION.
- PRACTICAL WORKING LOADS DEPEND ON SUPPORTING SURFACE, WIND, AND OTHER FACTORS AFFECTING STABILITY, HAZARDOUS SURROUNDINGS, EXPERIENCE OF PERSONNEL, AND PROPER HANDLING, ALL OF WHICH MUST BE TAKEN INTO ACCOUNT BY THE OPERATOR.
- THE MAXIMUM LOAD WHICH MAY BE TELESCOPED IS LIMITED BY HYDRAULIC PRESSURE, BOOM ANGLE, AND POWERED BOOM LUBRICATION. IT IS SAFE TO ATTEMPT TO TELESCOPE ANY LOAD WITHIN THE LIMITS OF THE LOAD RATING CHART.

DEFINITIONS:

- OPERATING RADIUS IS THE HORIZONTAL DISTANCE FROM THE AXIS OF ROTATION BEFORE LOADING TO THE CENTER OF THE VERTICAL HOIST LINE OR TACKLE WITH LOAD APPLIED.
- LOADED BOOM ANGLE, AS SHOWN IN COLUMN HEADED BY Δ°, IS THE INCLUDED ANGLE BETWEEN THE HORIZONTAL AND LONGITUDINAL AXES OF THE BOOM BASE AFTER LIFTING RATED LOAD AT RATED RADIUS.

DEDUCTIONS TO BE MADE FROM LOAD RATINGS IN POUNDS							
DESCRIPTION	WITHOUT HOOK BLOCK ON BOOM POINT	HOOK BLOCK ON POWERED BOOM POINT					
		5 TON	10-22 TON	5 TON WITH AUXILIARY SHEAVE	10-22 TON WITH AUXILIARY SHEAVE		
HOISTING LOAD FROM POWERED BOOM	HOOK BLOCK WEIGHT	---	150	350	250	450	
		STOWED	---	150	350	250	450
		ERECTED ONLY	---	1350	1550	1450	1650
	25 FT. LATTICE EXTENSION	5 TON BLOCK	---	1650	1850	1750	1950
		10 TON BLOCK	---	2100	2300	2200	2400
		---	---	---	---	---	---
	25.5 FT. LATTICE EXTENSION	STOWED	---	150	350	250	450
		ERECTED ONLY	---	2050	2250	2150	2350
		5 TON BLOCK	---	2350	2550	2450	2650
	10 TON BLOCK	---	---	2800	3000	2900	3100
		---	---	---	---	---	---
		---	---	---	---	---	---
35.5 FT. LATTICE EXTENSION	ERECTED ONLY	---	2250	2450	2350	2550	
	5 TON BLOCK	---	2600	2800	2700	2900	
	10 TON BLOCK	---	3150	3350	3250	3450	
14.5 FT. JIB	STOWED	---	250	450	350	550	
	ERECTED ONLY	---	850	1050	950	1150	
	5 TON BLOCK	---	1050	1250	1150	1350	
10 TON BLOCK	---	1400	1600	1500	1700		
HOISTING LOAD FROM EXTENSION OR JIB	25 FT. LATTICE EXTENSION	5 TON BLOCK	150	250	350	300	400
		10 TON BLOCK	350	450	550	500	600
	25.5 FT. LATTICE EXTENSION	5 TON BLOCK	150	250	350	300	400
		10 TON BLOCK	350	450	550	500	600
	35.5 FT. LATTICE EXTENSION	5 TON BLOCK	150	250	350	250	400
		10 TON BLOCK	350	450	550	450	600
	14.5 FT. JIB	5 TON BLOCK	150	250	400	300	450
		10 TON BLOCK	350	450	600	500	650

NOTE: LOAD DEDUCTIONS APPLY ONLY TO P&H SUPPLIED EQUIPMENT.

72 foot — three section powered boom rated crane loads in pounds —

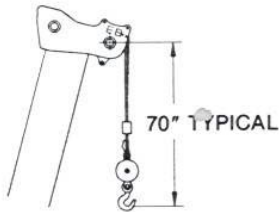

DIMENSIONS TYPICAL FOR ALL ATTACHMENTS

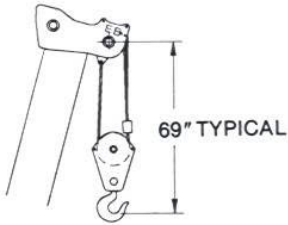

OPERATING RADIUS FT.		POWERED BOOM LENGTH										OPERATING RADIUS FT.	
		29 FT. 360°	40 FT. 360°	48 FT. 360°	56 FT. 360°	64 FT. 360°	72 FT. 360°						
10	63	44000	71	38100	75	37400						10	
12	58	40000	68	37500	72	35600						12	
15	51	33400	63	32600	68	30800	72	29400	75	27900		15	
20	34	24900	55	24900	62	24900	67	24100	70	23000	73	21700	20
25			45	19200	54	19200	61	19200	65	19200	69	18400	25
30			32	15400	46	15400	54	15400	60	15400	64	15400	30
35					37	11900	47	11900	54	11900	60	11900	35
40					23	9300	39	9300	48	9300	54	9300	40
45							30	7500	42	7500	49	7500	45
50							13	6100	34	6100	43	6100	50
55									23	5100	36	5100	55
60											28	4200	60
65											16	3500	65

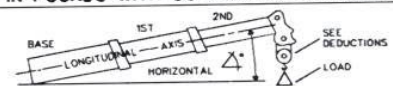

INFORMATION:

1. CRANE LOAD RATINGS DO NOT EXCEED 85% OF TIPPING.
2. RATINGS ABOVE THE HEAVY LINE ARE BASED ON THE MACHINE'S HYDRAULIC OR STRUCTURAL COMPETENCE AND NOT ON MACHINE STABILITY.
3. DEDUCTIONS MUST BE MADE FROM RATED LOADS FOR STOWED LATTICE EXTENSION, OPTIONAL ATTACHMENTS, HOOKS AND HOOKBLOCKS (SEE DEDUCTIONS CHART), WEIGHTS OF SLINGS AND ALL OTHER LOAD HANDLING DEVICES SHALL BE CONSIDERED A PART OF THE LOAD.
4. CRANE LOAD RATINGS WITH OUTRIGGERS ARE BASED ON OUTRIGGERS FULLY EXTENDED AND SET TO A DISTANCE OF 9 FEET FROM THE LONGITUDINAL AXIS OF THE CARRIER TO THE OUTRIGGER FLOAT PIVOT CONNECTION WITH ALL LOAD REMOVED FROM CARRIER WHEELS.

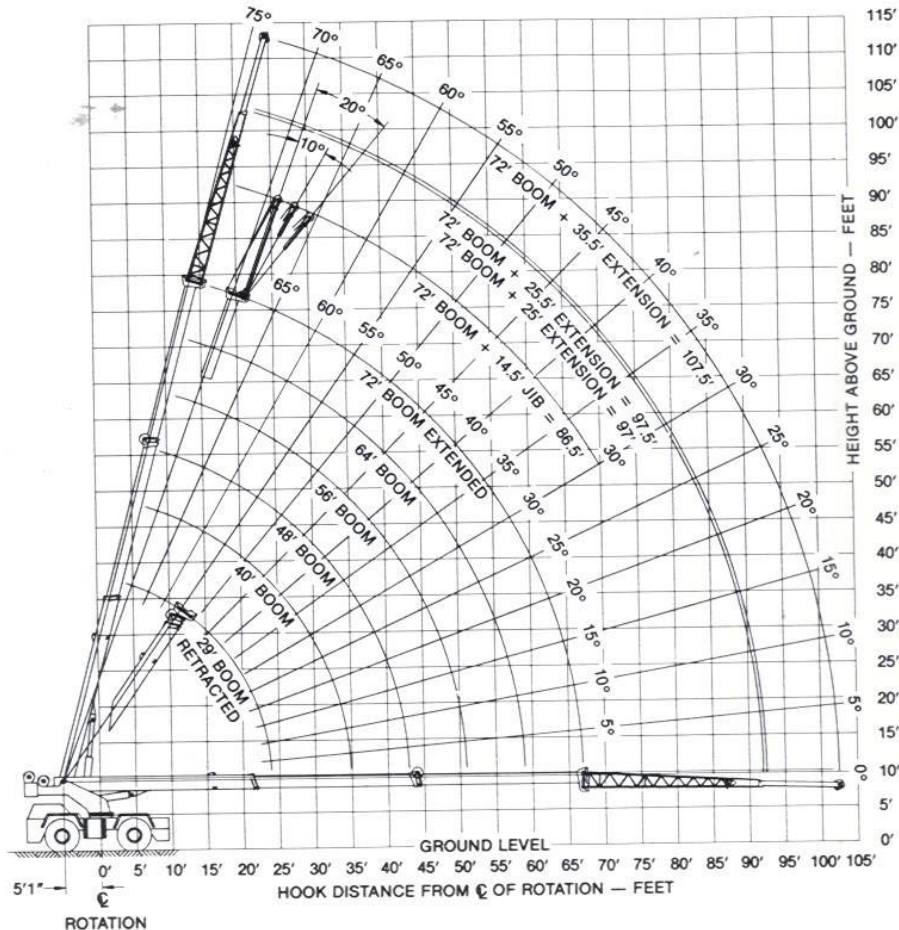

"with outriggers fully extended and set"

PCSA CLASS 10 - 93

boom in 360° work areas

OMEGA 122 - 22 TON

LATTICE EXTENSION LOAD RATINGS IN POUNDS WITH OUTRIGGERS EXTENDED									
OPERATING RADIUS IN FT.	25 FT. LATTICE EXTENSION			25.5-35.5 FT. LATTICE EXTENSION RETRACTED			25.5-35.5 FT. LATTICE EXTENSION EXTENDED		
	FOR ALL BOOM LENGTHS UP TO 97 FT.			FOR ALL BOOM LENGTHS UP TO 97.5 FT.			FOR ALL BOOM LENGTHS UP TO 107.5 FT.		
	△	RATED LOAD IN POUNDS		△	RATED LOAD IN POUNDS		△	RATED LOAD IN POUNDS	
		360°			360°			360°	
27	75	13000		27	75	13000	27		
30	73	12300		30	73	11900	30	75	9300
35	70	11100		35	70	10700	35	72	8800
40	66	10000		40	66	9700	40	69	8300
45	63	8200		45	63	7900	45	66	7900
50	59	6800		50	59	6500	50	63	6900
55	56	5700		55	56	5500	55	60	5800
60	52	4900		60	52	4600	60	57	4900
65	47	4100		65	48	3900	65	53	4200
70	43	3600		70	43	3300	70	49	3600
75	38	3100		75	38	2800	75	45	3100
80	32	2600		80	33	2300	80	41	2700
85	25	2200		85	26	2000	85	37	2300
90	15	1900		90	16	1600	90	31	1900
							95	25	1600
							100	16	1400

NOTE:
 1. WHEN BOOM IS NOT FULLY EXTENDED, USE ONLY BOOM ANGLES TO DETERMINE LOAD RATING.
 2. FOR BOOM ANGLES NOT SHOWN, USE RATING OF NEXT LOWER BOOM ANGLE.

MAXIMUM JIB LOAD RATINGS IN POUNDS WITH OUTRIGGERS EXTENDED			
MIN. BOOM ANGLE	JIB ANGLE		
	0°	10°	20°
	75°	13000	11200
70°	12000	10500	8500
65°	10500	9600	7800
60°	8000	7500	7200
55°	6300	6000	5800
50°	5200	5000	4800
45°	4300	4200	4100
40°	3700	3600	3500
35°	3200	3100	3100
30°	2800	2800	2800

JIB CAPACITY NOTES:
 1. JIB LOAD RATINGS ABOVE HEAVY LINE ARE BASED ON STRUCTURAL COMPETENCE OF THE MACHINE. RATINGS BELOW LINE ARE BASED ON STABILITY OF THE MACHINE AND DO NOT EXCEED 85% OF TIPPING LOAD WITH FULLY EXTENDED OUTRIGGERS. USE OF OUTRIGGERS IS REQUIRED WHEN BOOM IS EQUIPPED WITH JIB.
 2. FOR BUCKET RATINGS ON JIB, DEDUCT 20% FROM MAXIMUM JIB LOAD RATINGS.
 3. WARNING: DO NOT LIFT WITH JIB AT BOOM ANGLES BELOW 30°. LOSS OF STABILITY OCCURS RAPIDLY.

MAIN & AUXILIARY HOIST REEVING 6 x 25									
1/2 DIA. WIRE ROPE BREAKING STRENGTH 26,600 LBS.									
PART OF LINE	1	2	3	4	5	6	7	8	9
MAXIMUM LOAD	7600	15200	22800	30400	38000	44000			

MAIN & AUXILIARY HOIST REEVING 8 x 19									
1/2 DIA. WIRE ROPE BREAKING STRENGTH 23,400 LBS.									
PART OF LINE	1	2	3	4	5	6	7	8	9
MAXIMUM LOAD	6680	13350	20000	26700	33400	40000	44000		

WARNINGS:

- LOADED BOOM ANGLES AT SPECIFIED BOOM LENGTHS GIVE ONLY AN APPROXIMATION OF THE OPERATING RADIUS. THE BOOM ANGLE BEFORE LOADING SHOULD BE GREATER TO ACCOUNT FOR DEFLECTIONS. DO NOT EXCEED THE OPERATING RADIUS FOR RATED LOADS.
- POSITIONING OR OPERATION OF POWERED BOOM LENGTHS AT RADII BEYOND THE MAXIMUMS OR MINIMUMS SHOWN, IS NOT INTENDED OR APPROVED.
- POSITIONING OR OPERATION OF LATTICE EXTENSIONS OR JIB AT BOOM ANGLES BEYOND THE MAXIMUMS OR MINIMUMS SHOWN, IS NOT INTENDED OR APPROVED.
- FOR POWERED BOOM LENGTHS NOT SHOWN, USE RATING OF NEXT LONGER POWERED BOOM. FOR LOAD RADII NOT SHOWN, USE RATING OF NEXT LONGER RADIUS.
- CRANE LOAD RATINGS ON OUTRIGGERS ARE BASED ON FREELY SUSPENDED LOADS WITH THE MACHINE LEVELED AND STANDING ON A FIRM UNIFORM SUPPORTING SURFACE. NO ATTEMPT SHALL BE MADE TO MOVE A LOAD HORIZONTALLY ON THE GROUND IN ANY DIRECTION.
- PRACTICAL WORKING LOADS DEPEND ON SUPPORTING SURFACE, WIND, AND OTHER FACTORS AFFECTING STABILITY, HAZARDOUS SURROUNDINGS, EXPERIENCE OF PERSONNEL, AND PROPER HANDLING, ALL OF WHICH MUST BE TAKEN INTO ACCOUNT BY THE OPERATOR.
- THE MAXIMUM LOAD WHICH MAY BE TELESCOPED IS LIMITED BY HYDRAULIC PRESSURE, BOOM ANGLE, AND POWERED BOOM LUBRICATION. IT IS SAFE TO ATTEMPT TO TELESCOPE ANY LOAD WITHIN THE LIMITS OF THE LOAD RATING CHART.

DEFINITIONS:

- OPERATING RADIUS IS THE HORIZONTAL DISTANCE FROM THE AXIS OF ROTATION BEFORE LOADING TO THE CENTER OF THE VERTICAL HOIST LINE OR TACKLE WITH LOAD APPLIED.
- LOADED BOOM ANGLE, AS SHOWN IN COLUMN HEADED BY Δ°, IS THE INCLUDED ANGLE BETWEEN THE HORIZONTAL AND LONGITUDINAL AXES OF THE BOOM BASE AFTER LIFTING RATED LOAD AT RATED RADIUS.

DEDUCTIONS TO BE MADE FROM LOAD RATINGS IN POUNDS							
DESCRIPTION	WITHOUT HOOK BLOCK ON BOOM POINT	HOOK BLOCK ON POWERED BOOM POINT					
		5 TON	10-22 TON	5 TON WITH AUXILIARY SHEAVE	10-22 TON WITH AUXILIARY SHEAVE		
HOISTING LOAD FROM POWERED BOOM	HOOK BLOCK WEIGHT	---	150	350	250	450	
	25 FT. LATTICE EXTENSION	STOWED	---	200	400	300	500
		ERECTED ONLY	---	1200	1400	1300	1500
		5 TON BLOCK	---	1450	1650	1550	1750
	10 TON BLOCK	---	1850	2050	1950	2150	
	25.5 FT. LATTICE EXTENSION	STOWED	---	150	350	250	450
		ERECTED ONLY	---	1850	2050	1950	2150
		5 TON BLOCK	---	2100	2300	2200	2400
	10 TON BLOCK	---	2500	2700	2600	2800	
	35.5 FT. LATTICE EXTENSION	ERECTED ONLY	---	2000	2200	2100	2300
		5 TON BLOCK	---	2300	2500	2400	2600
		10 TON BLOCK	---	3050	2950	3150	3050
14.5 FT. JIB	STOWED	---	300	500	400	600	
	ERECTED ONLY	---	800	1000	900	1100	
	5 TON BLOCK	---	1000	1200	1100	1300	
10 TON BLOCK	---	1300	1500	1400	1600		
HOISTING LOAD FROM EXTENSION OR JIB	25 FT. LATTICE EXTENSION	5 TON BLOCK	150	250	400	300	450
		10 TON BLOCK	350	450	600	500	650
	25.5 FT. LATTICE EXTENSION	5 TON BLOCK	150	250	400	300	450
		10 TON BLOCK	350	450	600	500	650
	35.5 FT. LATTICE EXTENSION	5 TON BLOCK	150	250	350	300	400
		10 TON BLOCK	350	450	550	500	600
	14.5 FT. JIB	5 TON BLOCK	150	250	400	300	450
		10 TON BLOCK	350	450	600	500	650

NOTE: LOAD DEDUCTIONS APPLY ONLY TO P&H SUPPLIED EQUIPMENT.

"on tires"

62 foot — three section powered boom

rated crane loads in pounds — main boom — without outriggers

OPERATING RADIUS F.T.	16.00 X 24-16 PLY TIRES			
	STATIONARY		PICK & CARRY BOOM CENTERED OVER FRONT	
	±6° ARC OVER FRONT	360° ARC	CREEP	2 1/2 MPH
10	33400	23900	28600	19000
12	28900	17700	24900	16300
15	21400	12300	20600	13300
20	13500	7800	13000	10000
25	9400	5300	9100	7800
30	6900	3700	6600	6200
35	5300	2700	5100	5000
40	4000	1800	3900	3900
45	3100	1300	3100	3100
50	2400		2400	2400
55	1800		1800	1800
60				

32U2435

OPERATING RADIUS F.T.	14.00 X 24-20 PLY TIRES			
	STATIONARY		PICK & CARRY BOOM CENTERED OVER FRONT	
	±6° ARC OVER FRONT	360° ARC	CREEP	2 1/2 MPH
10	28800	22400	24300	18700
12	24800	18100	21000	16100
15	20400	12600	17400	13100
20	13400	7900	13000	9900
25	9400	5400	9100	7700
30	6900	3800	6600	6100
35	5200	2700	5000	4900
40	4000	1900	3900	3900
45	3000	1300	3000	3000
50	2400		2400	2400
55	1800		1800	1800
60				

32U2433

OPERATING RADIUS F.T.	16.00 X 25-24 PLY TIRES			
	STATIONARY		PICK & CARRY BOOM CENTERED OVER FRONT	
	±6° ARC OVER FRONT	360° ARC	CREEP	2 1/2 MPH
10	33700	25200	31600	26800
12	29200	18600	27600	23300
15	21900	13000	21100	19300
20	13800	8200	13300	13300
25	9600	5600	9300	9300
30	7100	3900	6800	6800
35	5400	2800	5200	5200
40	4100	2000	4000	4000
45	3200	1400	3200	3200
50	2500		2500	2500
55	1900		1900	1900
60				

32U2439

OPERATING RADIUS F.T.	17.50 X 25-20 PLY TIRES			
	STATIONARY		PICK & CARRY BOOM CENTERED OVER FRONT	
	±6° ARC OVER FRONT	360° ARC	CREEP	2 1/2 MPH
10	29000	22400	24500	18800
12	25100	17500	21200	16100
15	20600	12200	17500	13200
20	13400	7600	12900	9900
25	9400	5200	9100	7700
30	6900	3600	6600	6100
35	5200	2600	5100	4900
40	4000	1800	3900	3900
45	3000	1200	3000	3000
50	2400		2400	2400
55	1800		1800	1800
60				

OPERATING RADIUS F.T.	20.50 X 25-20 PLY TIRES			
	STATIONARY		PICK & CARRY BOOM CENTERED OVER FRONT	
	±6° ARC OVER FRONT	360° ARC	CREEP	2 1/2 MPH
10	32900	25600	28600	20200
12	28500	19100	24900	17400
15	22000	13300	20600	14300
20	13800	8400	13300	10800
25	9700	5800	9300	8500
30	7100	4100	6800	6700
35	5400	3000	5200	5200
40	4200	2100	4000	4000
45	3200	1500	3200	3200
50	2500	1000	2500	2500
55	1900		1900	1900
60				

32U2437

WARNINGS:

1. WHEN TRANSPORTING A LOAD, MACHINE MUST BE ON FIRM, LEVEL SURFACE WITH MECHANICAL HOUSELOCK ENGAGED. THE LOAD MUST BE CENTERED OVER FRONT OF MACHINE AND RESTRAINED FROM SWINGING. SEE AREAS OF OPERATION PLATE FOR WORKING RANGES.
2. CRANE LOAD RATINGS ON TIRES APPLY ONLY WHEN REAR AXLE LOCKOUTS ARE ENGAGED WHEN SWINGING 360°.
3. DO NOT ATTEMPT LIFTS ON TIRES WITH JIB OR EXTENSION ERECTED.
4. LIFT LOADS WITH SHORTEST BOOM POSSIBLE FOR EACH RADIUS.

DEFINITIONS:

1. CREEP IS MOTION FOR LESS THAN 200 FT. IN A 30 MINUTE PERIOD AND NOT EXCEEDING 1 M.P.H.

INFORMATION:

1. RATINGS ABOVE THE HEAVY LINE ARE BASED ON STRUCTURAL COMPETENCE AND NOT ON MACHINE STABILITY.
2. IT IS RECOMMENDED THAT OUTRIGGERS BE EXTENDED AS FAR AS POSSIBLE AND CLEAR OF GROUND WHEN LIFTING ON TIRES.
3. STABILITY RATINGS DO NOT EXCEED 85% OF TIPPING LOADS.

DEDUCTIONS TO BE MADE FROM LOAD RATINGS IN POUNDS					
HOOK BLOCK		HOOK BLOCK ON POWERED BOOM POINT			
		3 TON	10-22 TON	5 TON WITH AUXILIARY SHEAVE	10-22 TON WITH AUXILIARY SHEAVE
HOOK BLOCK WEIGHT		150	350	250	450
STORED EXTENSION OR JIB	25 FT. BOOM EXTENSION	300	500	400	600
	25.5-35.5 FT. BOOM EXTENSION	300	500	400	600
	14.5 FT. JIB	450	650	550	750

NOTE: LOAD DEDUCTIONS APPLY ONLY TO P&H SUPPLIED EQUIPMENT.

TIRE INFLATION			
SIZE	STATIC & CREEP	2 1/2 MPH	TRAVEL
16.00 X 24-16 PR	80 PSI	60 PSI	50 PSI
14.00 X 24-20 PR	110 PSI	100 PSI	75 PSI
16.00 X 25-24 PR	100 PSI	100 PSI	75 PSI
17.50 X 25-20 PR	95 PSI	85 PSI	60 PSI
20.50 X 25-20 PR	80 PSI	65 PSI	50 PSI

WARNING: CRANE LOAD RATINGS WITHOUT OUTRIGGERS DEPENDS ON TIRE CAPACITY AND CONDITION OF TIRES, INFLATED PER TABLE.

“on tires”

72 foot — three section powered boom

rated crane loads in pounds — main boom — without outriggers

OPERATING RADIUS IN FT.	16.00 X 24-16 PLY TIRES			
	STATIONARY		PICK & CARRY BOOM CENTERED OVER FRONT	
	±6° ARC OVER FRONT	360° ARC	CREEP	2 1/2 MPH
10	33300	25400	28400	18800
12	28800	18600	24600	16100
15	22500	13000	20400	13100
20	13900	8000	13400	9600
25	9700	5500	9400	7500
30	7000	3800	6800	5800
35	5400	2700	5200	4600
40	4100	1800	3900	3600
45	3100	1200	3100	2900
50	2300		2300	2300
55	1700		1700	1700
60	1300		1300	1300

32U2428

OPERATING RADIUS IN FT.	14.00 X 24-20 PLY TIRES			
	STATIONARY		PICK & CARRY BOOM CENTERED OVER FRONT	
	±6° ARC OVER FRONT	360° ARC	CREEP	2 1/2 MPH
10	28700	22600	24100	18500
12	24700	19000	20800	15900
15	20300	13300	17100	12900
20	13900	8200	12900	9500
25	9700	5600	9400	7300
30	7000	3900	6800	5700
35	5400	2800	5200	4500
40	4100	1900	3900	3600
45	3100	1300	3000	2800
50	2300		2300	2200
55	1800		1700	1700
60	1300		1300	1300

32U2192

OPERATING RADIUS IN FT.	16.00 X 25-24 PLY TIRES			
	STATIONARY		PICK & CARRY BOOM CENTERED OVER FRONT	
	±6° ARC OVER FRONT	360° ARC	CREEP	2 1/2 MPH
10	33600	26100	31400	26600
12	29000	19700	27300	23100
15	22900	13700	22100	19100
20	14200	8400	13700	13700
25	9900	5800	9600	9600
30	7200	4000	7000	7000
35	5500	2900	5300	5300
40	4200	2000	4000	4000
45	3200	1400	3200	3200
50	2400		2400	2400
55	1800		1800	1800
60	1400		1400	1400

32U2432

OPERATING RADIUS IN FT.	17.50 X 25-20 PLY TIRES			
	STATIONARY		PICK & CARRY BOOM CENTERED OVER FRONT	
	±6° ARC OVER FRONT	360° ARC	CREEP	2 1/2 MPH
10	28900	22500	24300	18500
12	24900	18500	21000	15900
15	20400	12900	17300	12900
20	13800	7900	13000	9500
25	9700	5400	9300	7400
30	7000	3700	6800	5700
35	5300	2600	5100	4500
40	4000	1800	3900	3600
45	3000	1200	3000	2900
50	2300		2300	2200
55	1700		1700	1700
60	1300		1300	1300

OPERATING RADIUS IN FT.	20.50 X 25-20 PLY TIRES			
	STATIONARY		PICK & CARRY BOOM CENTERED OVER FRONT	
	±6° ARC OVER FRONT	360° ARC	CREEP	2 1/2 MPH
10	32800	25700	28400	20000
12	28300	20200	24700	17200
15	23000	14000	20400	14000
20	14200	8700	13700	10400
25	10000	6000	9600	8100
30	7300	4100	7000	6300
35	5500	3000	5300	5100
40	4200	2100	4100	4100
45	3200	1500	3200	3200
50	2400		2400	2400
55	1900		1900	1900
60	1400		1400	1400

32U2430

WARNINGS:

1. WHEN TRANSPORTING A LOAD, MACHINE MUST BE ON FIRM, LEVEL SURFACE WITH MECHANICAL HOUSELOCK ENGAGED. THE LOAD MUST BE CENTERED OVER FRONT OF MACHINE AND RESTRAINED FROM SWINGING. SEE AREAS OF OPERATION PLATE FOR WORKING RANGES.
2. CRANE LOAD RATINGS ON TIRES APPLY ONLY WHEN REAR AXLE LOCKOUTS ARE ENGAGED WHEN SWINGING 360°.
3. DO NOT ATTEMPT LIFTS ON TIRES WITH JIB OR EXTENSION ERECTED.
4. LIFT LOADS WITH SHORTEST BOOM POSSIBLE FOR EACH RADIUS.

DEFINITIONS:

1. CREEP IS MOTION FOR LESS THAN 200 FT. IN A 30 MINUTE PERIOD AND NOT EXCEEDING 1 M.P.H.

INFORMATION:

1. RATINGS ABOVE THE HEAVY LINE ARE BASED ON STRUCTURAL COMPETENCE AND NOT ON MACHINE STABILITY.
2. IT IS RECOMMENDED THAT OUTRIGGERS BE EXTENDED AS FAR AS POSSIBLE AND CLEAR OF GROUND WHEN LIFTING ON TIRES.
3. STABILITY RATINGS DO NOT EXCEED 85% OF TIPPING LOADS.

DEDUCTIONS TO BE MADE FROM LOAD RATINGS IN POUNDS				
HOOK BLOCK	HOOK BLOCK ON POWERED BOOM POINT			
	5 TON	10-22 TON	5 TON WITH AUXILIARY SHEAVE	10-22 TON WITH AUXILIARY SHEAVE
HOOK BLOCK WEIGHT	150	350	250	450
STOWED EXTENSION OR JIB	25 FT. BOOM EXTENSION	450	650	750
	25.5-35.5 FT. BOOM EXTENSION	500	700	800
	14.5 FT. JIB	500	700	800

NOTE: LOAD DEDUCTIONS APPLY ONLY TO P&H SUPPLIED EQUIPMENT.

TIRE INFLATION			
SIZE	STATIC & CREEP	2 1/2 MPH	TRAVEL
16.00 X 24-16 PR	80 PSI	60 PSI	50 PSI
14.00 X 24-20 PR	110 PSI	100 PSI	75 PSI
16.00 X 25-24 PR	100 PSI	100 PSI	75 PSI
17.50 X 25-20 PR	95 PSI	85 PSI	60 PSI
20.50 X 25-20 PR	80 PSI	65 PSI	50 PSI

WARNING: CRANE LOAD RATINGS WITHOUT OUTRIGGERS DEPENDS ON TIRE CAPACITY AND CONDITION OF TIRES, INFLATED PER TABLE.

dimensions

DIMENSIONS ARE WITH STANDARD TIRE SIZE — 16:00 x 24
 WITH 14.00 X 24 TIRES - DEDUCT 1 3/8" (34.9 mm) FROM HEIGHT DIMENSIONS
 WITH 20.5 x 25 TIRES - ADD 3/8" (9.5 mm) TO HEIGHT DIMENSIONS
 WITH 16:00 x 25 TIRES - ADD 1/8" (22.3 mm) TO HEIGHT DIMENSIONS
 WITH 17.50 x 25 TIRES - DEDUCT 2 1/2" (63.5mm) FROM HEIGHT DIMENSIONS

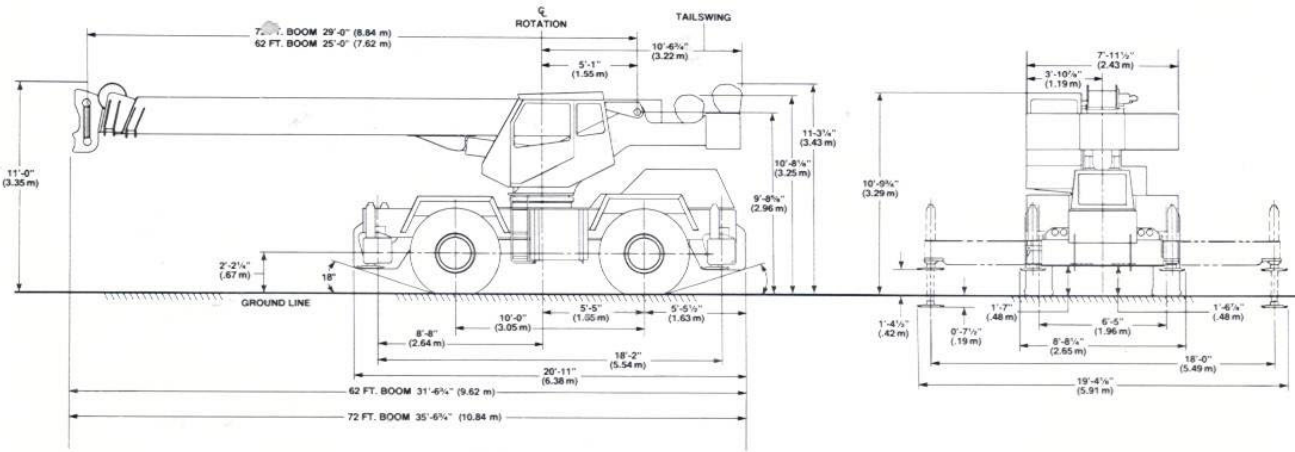

TIRES

	14:00x24	16:00x24	20.5x25	16:00x25	17:50x25
VEHICLE TURNING DIAMETER — 4 WHEEL STEER CRAMP	30'7 3/4" (9.34m)	37'9 1/2" (11.5m)	38'1 1/2" (11.61m)	37'11 1/4" (11.56m)	37'8 1/4" (11.49m)
— FRONT AXLE STEER	55'3 1/4" (16.78m)	69'3 3/4" (21.13m)	69'7 3/4" (21.23m)	69'5 1/8" (21.18m)	69'3" (21.11m)
VEHICLE CLEARANCE DIAMETER — 4 WHEEL STEER CRAMP	35'10 3/4" (10.94m)	42'7 7/8" (13.00m)	42'11 1/8" (13.08m)	42'8 1/4" (13.01m)	42'8" (13.01m)
— FRONT AXLE STEER	60'2 3/4" (18.36m)	74'1 3/4" (22.60m)	74'4 3/4" (22.68m)	74'1 1/8" (22.60m)	74'1 1/8" (22.60m)



NOTE: All designs, specifications and components of the equipment described above are subject to change at the manufacturer's sole discretion at any time without advance notice. Data published herein is informational in nature and shall not be construed to warrant suitability of the machine for any particular purpose as performance may vary with the conditions encountered. The only warranty applicable is our standard written warranty for this machine. Manufactured and sold in conformance with U.S. Department of Commerce Commercial Standard CS-90-58. Manufactured by Kobe Steel Ltd., Japan.

