



OWNER/OPERATOR MANUAL

GRADALL®

544D-10

9136-4142

January 11, 2007

Starting Serial No.
0355001 thru 0455632
& 0160000192 thru 0160003968
excluding 0160003856

Form #20220

Original Issue 6/03

CORPORATE OFFICE

JLG INDUSTRIES, INC.
1 JLG DRIVE
McConnellsburg, PA
17233-9533
USA
Telephone: (717) 485-5161
Fax: (717) 485-6417

GRADALL DIVISION

JLG INDUSTRIES, INC.
406 Mill Avenue S.W.
New Philadelphia, OH
44663
USA
Telephone: (330) 339-2211
Fax: (330) 339-8458

544D MATERIAL HANDLER OWNER/OPERATOR MANUAL

COVERING OPERATION & PERIODIC MAINTENANCE

GRADALL®

m a t e r i a l h a n d l e r

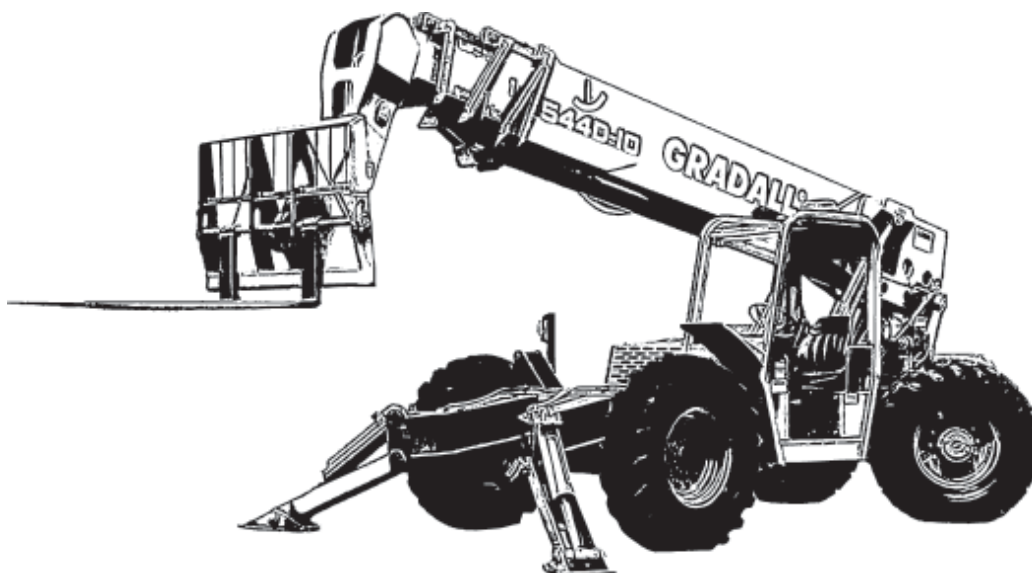

IMPORTANT!

Read and understand this Manual and the Gradall Material Handler Safety Manual before starting, operating or performing maintenance procedures on this machine.

KEEP OPERATOR AND SAFETY MANUALS IN CAB

A **JLG** Company

Form No. 20220

COVERS MATERIAL HANDLER MODEL 544D-10
STARTING SERIAL NUMBER
0355001 thru 0455632 & 0160000192
thru 0160003968 excluding 0160003856

JLG®

Part No. 9136-4142
Revised 01-11-07

IMPORTANT SAFETY NOTICE

Safe operation depends on reliable equipment and proper operating procedures. Performing the checks and services described in this Manual will help keep your GRADALL Material Handler in reliable condition. Following recommended operating procedures can help you avoid accidents. Because some procedures may be new to even the experienced operator, we require that this Manual be read, understood and complied with by all who operate this machine.

Strict attention to and compliance with instructions provided in this Manual, the GRADALL Material Handler Safety Manual, as well as instructional decals and plates affixed to the machine will help prevent injuries to personnel and damage to the equipment. The information provided herein is not intended to cover all situations; it is impossible to anticipate and evaluate all possible applications and methods of operation for this equipment.

This Manual covers recommended operating procedures and basic maintenance checks and services for the Material Handler. Detailed maintenance information is available in the appropriate Service Manual.

Any procedure not specifically recommended by GRADALL must be thoroughly evaluated from the standpoint of safety before it is placed in practice. If you are not sure, contact your GRADALL Material Handler Distributor before operating.

Use only GRADALL authorized parts. The use of counterfeit parts may cause premature failure which could lead to injuries and/or machine damage.

Do not modify this machine without written permission from GRADALL. Use only genuine GRADALL replacement parts.

OTHER NOTICES

GRADALL retains all proprietary rights to the information contained in this Manual.

GRADALL reserves the right to change specifications without notice.

Gradall is a registered trademark for Hydraulic Excavators, Hydraulic Material Handlers and Attachments manufactured by The Gradall Company.

TABLE OF CONTENTS

IMPORTANT SAFETY NOTICE	inside front cover
TABLE OF CONTENTS	
INTRODUCTION	
General	
Operator Qualifications	
Orientation	
Related Manuals & Decals	
Serial Number Location	
NOMENCLATURE	
SAFETY HIGHLIGHTS	1.0
DECALS	2.0
Decals Inside Cab	
Decals Outside Cab	
OPERATORS CAB	3.0
Cab	
Control & Instrument Identification	
CHECKS & SERVICES BEFORE STARTING ENGINE	4.0
WARM-UP & OPERATIONAL CHECKS	5.0
ENGINE OPERATION	6.0
Starting the Engine	
Cold-Weather Starting Aids	
Battery-Boosted Starting	
Normal Engine Operation	
Stopping the Engine	
John Deere Engine Shut-Down Protection Feature	
BRAKE SYSTEM	7.0
General	
Inching Travel	
Service Brakes	
Parking Brakes	
PARKING THE HANDLER	8.0
STEERING SYSTEM	9.0
DRIVE TRAIN	10.0
LEVELING THE HANDLER	11.0
OPERATING PROCEDURE & TECHNIQUES	12.0
Hydraulic Controls	
Rated Capacity Chart	
ATTACHMENTS	13.0
Approved Attachments	
Non-Approved Attachments	
Carriage/Fork Capacities	
Other Attachment Capacities	
Attachment Installation	
Attachment Operation	
OBTAINING HYDRAULIC OIL SAMPLE FOR ANALYSIS	14.0
LOADING & SECURING FOR TRANSPORT	15.0
MOVING HANDLER IN EMERGENCY	16.0
Moving Short Distances	
Moving Longer Distances	
To Activate Tow Bypass	
To Release Parking Brake	
To Restore Parking Brake	
MAINTENANCE SECTION	17.0
Nomenclature	
Lubrication and Maintenance	
Lubrication Chart	
Torque Chart	
Boom	
Stabilizer	
INSPECTION AND MAINTENANCE LOG	18.0
HAND SIGNALS	inside back cover

INTRODUCTION

General

This Manual provides important information regarding safe operating and maintenance requirements for GRADALL Material Handlers.

If you have any questions regarding the material handler, contact your GRADALL Material Handler Distributor.

Operator Qualifications

Operators of the material handler must be in good physical and mental condition, have normal reflexes and reaction time, good vision and depth perception and normal hearing. He must not be using medication which could impair abilities nor be under the influence of alcohol or any other intoxicant during the work shift.

The operator should possess a valid, applicable driver's license and must have completed a training course in the safe operation of this type of material handling equipment.

In addition, the operator must read/view, understand and comply with instructions contained in the following material furnished with the material handler:

- This Owner/Operator Manual
- GRADALL Material Handler Safety Manual
- All warning and instructional decals and plates
- Any optional equipment instructions furnished

The operator must also read, understand and comply with all applicable Employer, Industry and Governmental rules, standards and regulations.

Orientation

When used to describe the location of components in the material handler, the directions "front", "rear", "right" and "left" relate to the orientation of a person sitting in the operator's seat. (See Figure I-1)

Related Manuals & Decals

Separate publications are furnished with the material handler to provide information concerning safety, replacement parts, maintenance procedures, theory of operation and vendor components. Replacement manuals, decals and instruction plates can be ordered from your GRADALL Material Handler Distributor.

Models Covered

This Manual covers basic information for Gradall Material Handlers. Detailed information for each particular machine is in the maintenance section in the back of this manual. Be certain to refer to proper information for your unit and the operational equipment furnished on your machine.

Serial Number Location

Specify Model Number and Serial Number when ordering parts and when discussing specific applications and procedures with your Distributor. The model/serial number plate is located inside the operator's cab, right wall.

(See Figure I-2)

NOTE!

"Material handler" and handler are used interchangeably throughout this Manual.

NOTE!

Though no offense or discrimination is intended, only the masculine pronouns will be used throughout the remainder of this Manual.

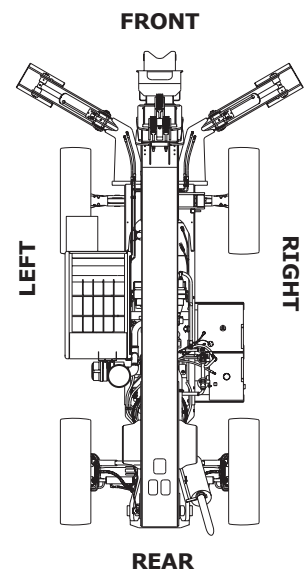

Figure I-1

CAPACITY WITH STANDARD		CAPACITY WITH MAXIMUM	
Capacity	Capacity with Standard	Capacity	Capacity with Maximum
10	8	5	5
34 ft	39 ft	55 ft	55 ft
24 in	24 in	24 in	24 in
24 in	24 in	24 in	24 in
6.5 ft	6.5 ft	6.5 ft	6.5 ft

Figure I-2

1.0 SAFETY HIGHLIGHTS

Read and understand all manuals and instructional material listed on cover, inside front cover and introduction page of this Manual before starting, operating or performing maintenance procedures on this equipment.

Operators of this equipment must have successfully completed a training course in the safe operation of this type of material handling equipment.

Regardless of previous experience operating similar equipment, the operator must be given sufficient opportunity to practice with the handler in a safe, open area (not hazardous to people or property) to gain operating skills and the proper "feel" for controls and operating clearances required for safe, efficient operation.

GRADALL Material Handlers are equipped with a right-side rearview mirror. This mirror is intended as an operator's aid and does not replace the requirement for line-of-sight. Certain job site and machine conditions may require use of a signal person to help the operator when picking, placing or transporting a load. Never operate the handler until you know pick-up point, line of travel and landing point are clear. Always be aware that objects in mirror are closer than they appear.

Safety Precautions

Make sure all **DANGER, WARNING, CAUTION and INSTRUCTIONAL DECALS** are in place and can be read. Clean or replace decals as required.

Ensure handler is on a firm, level surface before lifting or placing load. Have surface leveled if necessary. **Unit can tip over if load is raised with handler on a soft or uneven surface.**

Always look in the direction of travel. **Reduce speed and be especially careful when traveling in reverse and/or turning. Be aware of tail swing due to rear-pivot steering.**

If load or conditions obstruct view, **use a signal person** when lifting, carrying or placing a load.

Loose clothing can get caught in moving machinery and can also cause accidental actuation of controls. **Dress properly for the job.**

Be alert to any unusual response to controls. If unusual response is noticed, position handler in a safe area, lower forks to ground, apply parking brake, stop engine and remove key from ignition switch. Tag steering wheel to forbid operation and **notify maintenance personnel.**

Keep hands, gloves, shoes, control knobs and pedals clean. **Slippery controls can cause accidents.** Keep a firm grip on the steering wheel when traveling.

Load capacities are based on load center being within 24 inches (610mm) from front vertical face of forks.

Never service the handler with the engine running.

Release trapped pressure before disconnecting, opening or removing any hydraulic component.

WATCH FOR THESE SYMBOLS ; THEY CALL YOUR ATTENTION TO SAFETY NOTICES.



This symbol indicates an extreme hazard which will result in high probability of death or serious injury if proper precautions are not taken.



This symbol indicates a hazard which could result in death or serious injury if proper precautions are not taken.



This symbol indicates a hazard which may result in injury or damage to equipment or property if proper precautions are not taken.



Operator must be seated with seat belt fastened, forward reverse lever in "Neutral" position, parking brake applied and all hydraulic controls in "Neutral" before starting engine.

1.1

Keep all windows and mirror(s) clean. Adjust mirror(s) as required for maximum visibility, before and during operation.

Never permit diesel engine to run out of fuel. Doing so can cause severe engine damage.

DO NOT burn or drill holes in forks. Modifying any part of machine or attachment may affect machine capacity and/or stability.

Keep head, arms, hands, legs and all other body parts inside the operator's cab at all times.

DO NOT approach power lines, overhead or underground cables or other power sources with any part of your material handler or load unless all local, state/provincial and federal regulations have been met and the appropriate utility company has been contacted to de-energize the lines.

Whenever leaving the cab, perform standard shut-down procedure:

Standard Shut-Down Procedure

Position the handler in a safe location, apply parking brake, lower forks to ground, move all controls to "Neutral", allow engine to run at low idle for 3 to 5 minutes. Stop engine and remove ignition key. Block wheels.

Pinch Points

Stay clear of pinch points and rotating parts on the material handler. Getting caught in a pinch point or a moving part can cause serious injury or death. Before performing any maintenance on machine, follow the "STANDARD SHUT-DOWN PROCEDURE".

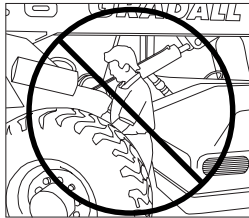

Rear Steering Axle



Boom

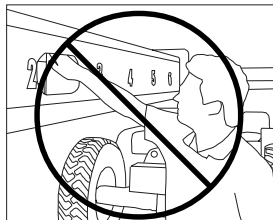

Boom Holes

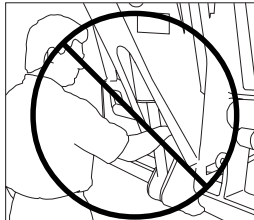

Attachment Tilt

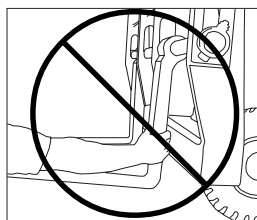

Carriage Forks

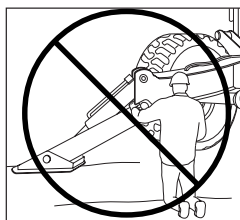

Stabilizers



Contact The Gradall Company prior to welding on machine.

BATTERIES AND RELATED PARTS CONTAIN LEAD

WASH HANDS AFTER HANDLING!

WARNING: Battery posts, terminal and related accessories contain lead and lead compounds, chemicals known to the State of California to cause cancer and reproductive harm.

CALIFORNIA PROPOSITION 65
BATTERY WARNING

Battery posts, terminals and related accessories contain lead and lead compounds, chemicals known to the State of California to cause cancer and reproductive harm.

WASH HANDS AFTER HANDLING !

2.0 DECALS

INSIDE THE CAB

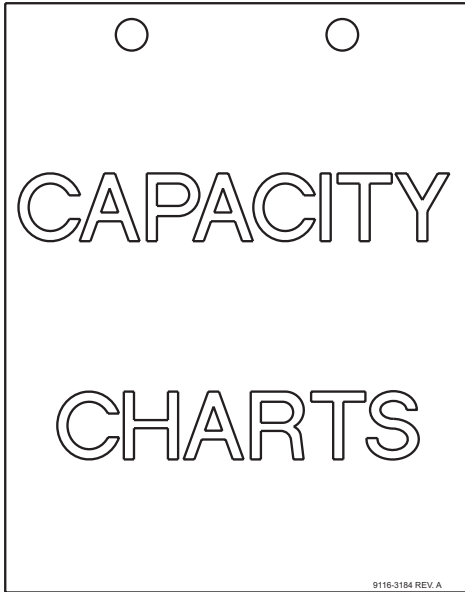

**Located on dashboard
P/N 9116-3184**

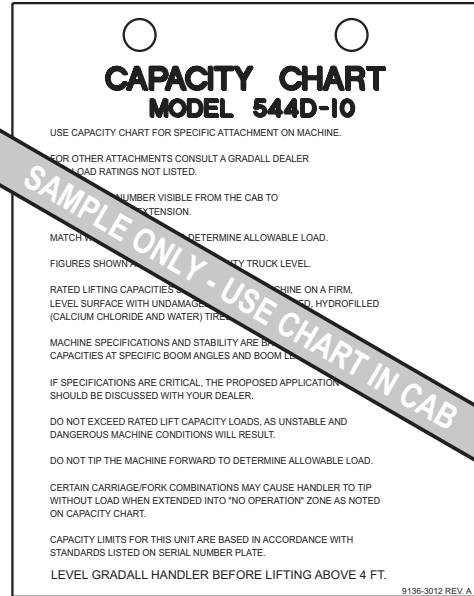

**Located on dashboard
P/N 9136-3012**

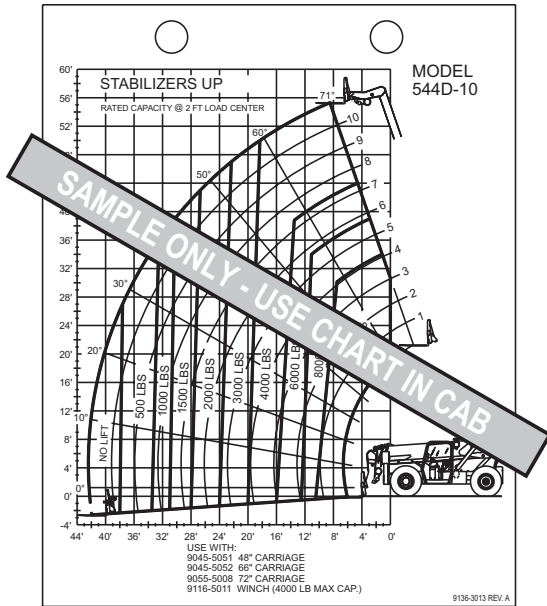

**Located on dashboard
P/N 9136-3013**

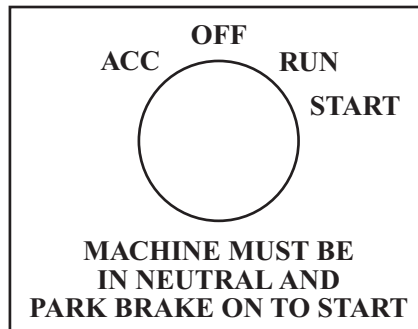

**Located on dashboard
P/N 9114-3120**



**Located on dashboard
P/N 9114-3182**

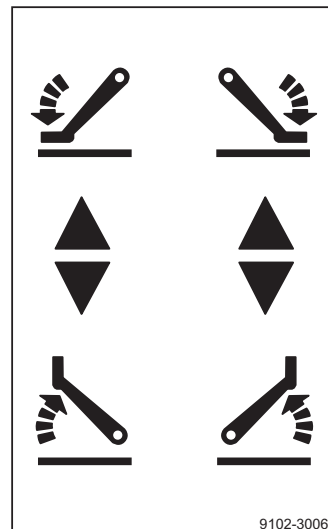

**Located on seat pedestal
P/N 9102-3006**

2.1

INSIDE THE CAB

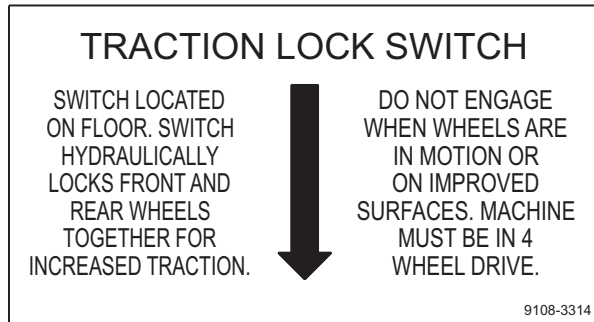

**Located on dashboard
P/N 9108-3314**

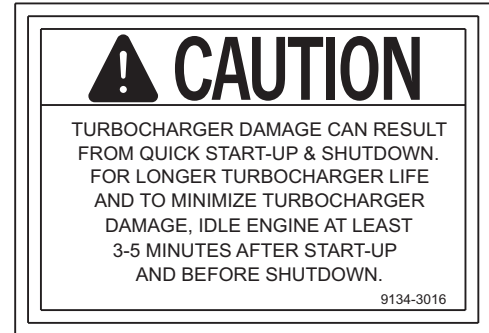

**Located on dashboard
P/N 9134-3016**

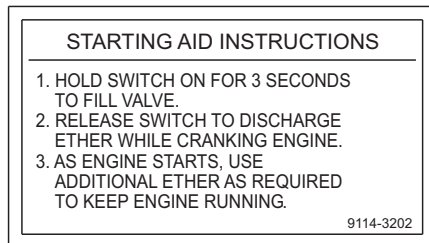

**Located on dashboard
(Cummins Engines Only)
P/N 9114-3202**

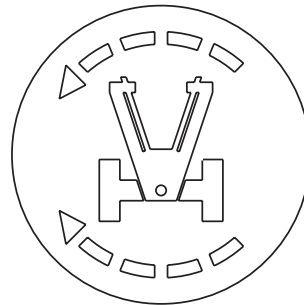

**Located on lever knob
P/N 9108-3318**

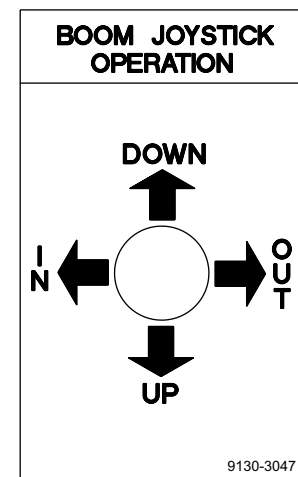

**Located on joystick pedestal
P/N 9130-3047**

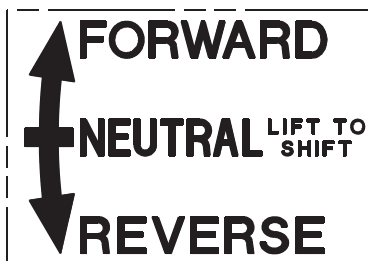

**Located on forward/reverse lever
P/N 9116-3028**

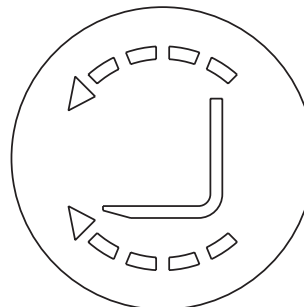

**Located on lever knob
P/N 9108-3317**

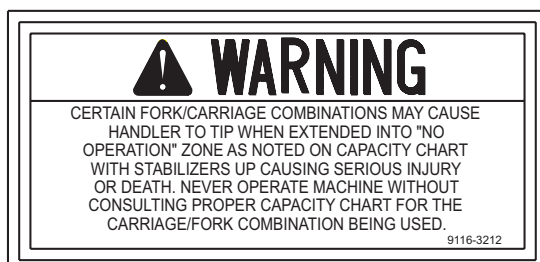

**Located on dashboard
P/N 9116-3212**



**Located on left cab wall
P/N 7733-3027**

INSIDE THE CAB

WARNING

NO RIDERS PERMITTED ON HANDLER.
OPERATOR ONLY IN MACHINE
WHILE RUNNING.
RIDERS COULD FALL OFF MACHINE
CAUSING SERIOUS INJURY OR DEATH.

9114-3283

Located on left cab wall
P/N 9114-3283

Box 61 SD 57201

GRADALL MATER 06/9/10

MAX WEIGHT : 2150

MEETS SAE : J1040 MA

MEETS ISO : 3471 (94) / 3

MEETS ANSI : B56.6 - 8.16 / P

GRADALL : SERIAL :

Located on left side, front cab plate
P/N 9116-4097 (enclosed cab)
P/N 9116-4093 (open cab)

GRADALL
MATERIAL HANDLER
A *ALL* COMPANY

MODEL **544D-10**

SERIAL NO

ENGINE SERIAL NO

WEIGHT (WITHOUT ATTACHMENTS) **32,670 LBS**

AS RELEASED FROM FACTORY THIS TRUCK MEETS THE DESIGN SPECIFICATIONS ESTABLISHED IN AMERICAN NATIONAL STANDARDS FOR POWERED INDUSTRIAL TRUCKS PART II ASME B56.6-1995

CAPACITY WITH STANDARD 48", 66" & 72" CARRIAGE		CARRIAGE	
CARRIAGE	10	8	5
A	34 FT	39 FT	55 FT
	24 IN	24 IN	24 IN
	24 IN	24 IN	24 IN
	6 FT	6 FT	6.5 FT

SHIPPED INFO	ATTACHMENT	TRUCK ATTACHMENT WEIGHT	A	B	C	D
	8" CARRIAGE P/N 9055-5001	10	34 FT	24 IN	24 IN	-8 FT
	8" CARRIAGE P/N 9055-5002	10	34 FT	24 IN	24 IN	-8 FT
	8" CARRIAGE P/N 9055-5008	10	34 FT	24 IN	24 IN	-8 FT
	1 1/4 YD BUCKET P/N 9055-5009	3	33,140	55 FT	24 IN	8.9 FT
	1 1/4 YD BUCKET P/N 9055-5009	3	33,140	55 FT	24 IN	8.9 FT
	WORK PLATFORM P/N 9055-5014	2	33,420	39 FT	---	---
	TRUSS BOOM P/N 9045-5011	2	33,280	65 FT	---	---
	TRUSS BOOM WITH WINCH P/N 9045-5012	1.6	33,520	65 FT	---	7.4 FT
	8" SWING MAST P/N 9045-5047	4	35,350	61 FT	24 IN	8.7 FT
	8" MAST W/8" CARR P/N 9045-5055	6	34,530	38 FT	24 IN	1.3 FT
	8" MAST W/8" CARR P/N 9045-5055	6	34,610	38 FT	24 IN	1.3 FT
	FZ 100" SWING CARR P/N 9045-5044	10	34,310	21 FT	24 IN	-2 FT
	8" SLOPE FLER P/N 9108-5058	10	33,780	33 FT	24 IN	-4 FT
	8" SLOPE FLER P/N 9108-5058	10	33,900	33 FT	24 IN	-4 FT
	FZ 180" SWING CARR P/N 9055-5054	10	34,890	21 FT	24 IN	-2 FT

*WEIGHTS ARE BASED ON USING 2 X 4 X 4" FORKS (APPROX. 4000 PER PAIR)
**BUCKET DIMENSIONS (A & D) REFER TO BUCKET LIP HEIGHT
***TRUSS BOOM, WINCH & CHOCK HOOK DIMENSIONS (A & D) REFER TO HOOK CENTER
****HEIGHT IS BASED ON 8" SWING MAST FORKS (APPROX. 1000 PER PAIR)
*****FORK DIMENSIONS (A & D) REFER TO CENTER OF FLOOR
*****FORKS RATED LESS THAN THE ATTACHMENT CAPACITY FROM A LOAD INCREASE CAPACITY OF ATTACHMENT TO THAT OF FORKS. FORKS RATED MORE THAN ATTACHMENT CAPACITY DO NOT INCREASE ATTACHMENT CAPACITY. (9136-5011) (REV. E)

Located on right cab wall
P/N 9136-3011

WARNING

THE PROTECTION OFFERED BY THIS ROPS WILL BE IMPAIRED IF IT HAS BEEN SUBJECTED TO ANY MODIFICATION, STRUCTURAL DAMAGE, OR HAS BEEN INVOLVED IN AN OVERTURN INCIDENT. THIS ROPS MUST BE REPLACED AFTER A ROLL-OVER. SEAT BELTS MUST BE WORN WHILE OPERATING VEHICLE.

000850

Located on left side, front cab plate
P/N 9116-4094

ENGINE OIL LEVEL

9114-3292

Located on right cab wall
(Cummins Engines Only)
P/N 9114-3292

WARNING

FOR SAFE OPERATION OF MACHINE AND TO MINIMIZE RISK OF SERIOUS INJURY, READ AND OBSERVE THE FOLLOWING:

1. ONLY TRAINED AND AUTHORIZED PERSONNEL MAY OPERATE THIS MACHINE.
2. BEFORE OPERATING, READ AND UNDERSTAND ALL CAPACITY CHARTS, OPERATOR MANUALS AND SAFETY MANUALS. IF MANUALS ARE NOT AVAILABLE, CONSULT AN AUTHORIZED GRADALL DEALER. UNDERSTAND ALL CONTROLS IN CAB AND CHECK FOR PROPER OPERATION. CLEAR LOOSE OBJECTS OFF MACHINE AND SOUND HORN BEFORE STARTING ENGINE.
3. OPERATOR MUST BE SEATED WITH SEAT BELT FASTENED. ASSURE FORWARD REVERSE LEVER IS IN NEUTRAL. PARK BRAKE APPLIED AND ALL HYDRAULIC CONTROLS ARE IN NEUTRAL BEFORE IGNITION SWITCH IS TURNED ON.
4. DO NOT OPERATE MACHINE WITHOUT PROPER CAPACITY CHART IN PLACE.
5. BEFORE MOVING, BE SURE OF A CLEAR PATH AND SOUND HORN. WATCH FOR PEDESTRIANS AND OBSTRUCTIONS. CHECK OVERHEAD AND SIDE CLEARANCES. ALWAYS LOOK IN DIRECTION OF TRAVEL.
6. START, TURN, AND BRAKE SMOOTHLY. REDUCE TRAVEL SPEEDS FOR TURNS, SLIPPERY, OR UNEVEN SURFACES. AVOID RUNNING OVER LOOSE OBJECTS OR HOLES IN THE ROADWAY SURFACE.
7. WHEN TRAVELING WITH LOAD, FULLY RETRACT BOOM AND PLACE FORKS IN CARRY POSITION. USE EXTREME CAUTION WHEN TURNING.
8. ON INCLINES, TRAVEL WITH LOAD UP-GRADE.
9. DO NOT USE BOOM AS WALKWAY.
10. USE TWO HANDS WHEN CLIMBING ON MACHINE.
11. USE ONLY A GRADALL MANUFACTURED PERSONNEL WORK PLATFORM FOR LIFTING PERSONNEL. NO RIDERS ON MACHINE, FORKS, LOAD, OR OTHER LIFTING ATTACHMENTS AT ANY TIME. DO NOT USE PERSONNEL WORK PLATFORM WITHOUT THE PROPER GRADALL MATERIAL HANDLER/PERSONNEL WORK PLATFORM CAPACITY CHART DISPLAYED IN THE CAB. DO NOT DRIVE MACHINE WITH PERSONNEL IN PLATFORM.
12. KEEP OTHERS AWAY FROM MACHINE WHILE OPERATING. DO NOT STAND UNDER BOOM OR LOAD.
13. USE EXTREME CARE WHEN HANDLING LONG, HIGH, OR WIDE LOADS. DO NOT HANDLE UNSTABLE OR LOOSELY STACKED LOADS.
14. FORKS TO BE CENTERED UNDER LOAD AND SPACED APART AS FAR AS POSSIBLE.
15. BEFORE ADJUSTING OR SERVICING, PLACE FORWARD REVERSE LEVER IN NEUTRAL, REST BOOM ON GROUND OR SUPPORT, SET PARKING BRAKE, SHUT OFF ENGINE AND CHOCK WHEELS.
16. BEFORE LEAVING MACHINE UNATTENDED, PLACE FORWARD REVERSE LEVER IN NEUTRAL, LOWER BOOM, SET PARKING BRAKE AND SHUT-OFF ENGINE. CHOCK WHEELS IF MACHINE MUST PARK ON AN INCLINE.
17. LEVEL MACHINE BEFORE LIFTING ANY LOAD ABOVE 4 FEET (IF EQUIPPED WITH FRAME LEVELING).
18. OPERATOR PROTECTION (SUCH AS HARD HATS, SAFETY GLASSES, AND/OR HEARING PROTECTION) SHOULD BE WORN WHEN JOB CONDITIONS WARRANT. ALWAYS USE SEAT BELT.
19. IMPROPER USE OF MACHINE COULD RESULT IN MACHINE TIPPING OVER. IF MACHINE STARTS TO TIP OVER, DO NOT LEAVE OPERATORS SEAT. LEAN AWAY FROM TIP & BRACE YOURSELF.
20. KEEP MIRROR(S) CLEAN AND PROPERLY ADJUSTED. OBJECTS IN MIRROR ARE CLOSER THAN THEY APPEAR.

9055-3028 REV. A

Located on right cab wall
P/N 9055-3028

2.3

OUTSIDE THE CAB

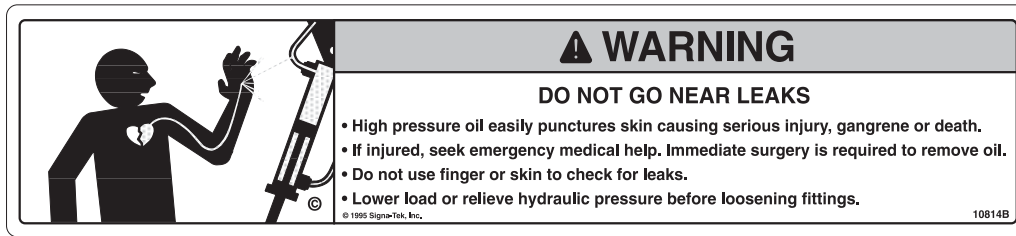

**Located on valve access cover in cab
Located on hydraulic reservoir
P/N 9108-3492**

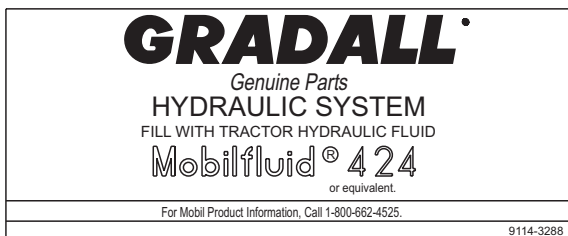

**Located on hydraulic reservoir
P/N 9114-3288**

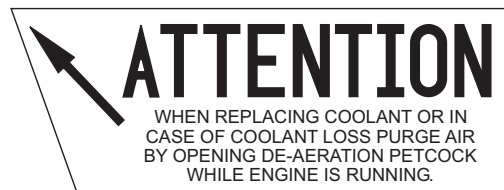

**Located on engine
(Cummins Engines Only)
P/N 9116-3256**



**Located on sheet metal cover of hydraulic reservoir and fuel tank
P/N 9114-3281**

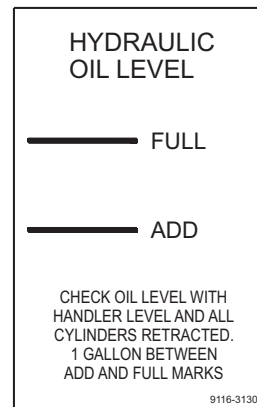

**Located on hydraulic reservoir
P/N 9116-3130**



**Located on right and left rear frame, hydraulic reservoir & boom head
P/N 9114-3282**

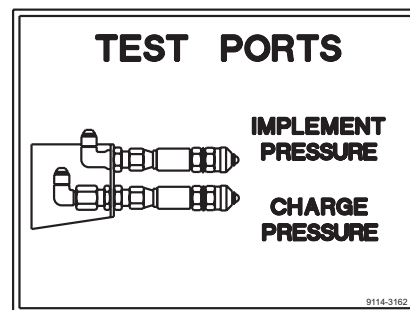

**Located on hydraulic filter bracket
P/N 9114-3162**

2.4

OUTSIDE THE CAB



**Located on engine compartment
P/N 9114-3280**

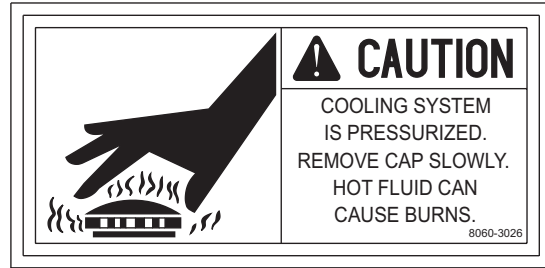

**Located on engine cover
P/N 8060-3026**

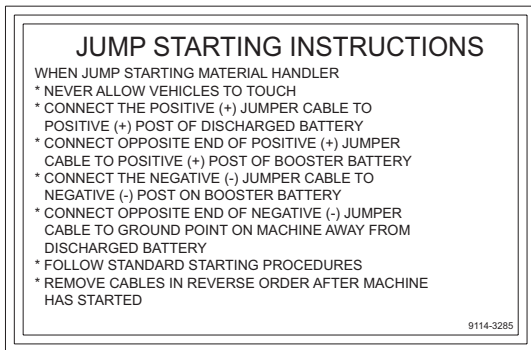

**Located beside battery
P/N 9114-3285**

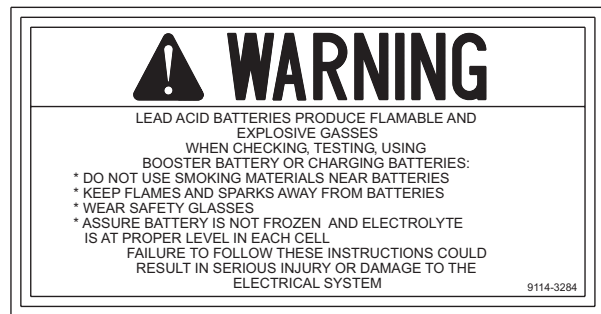

**Located beside battery
P/N 9114-3284**

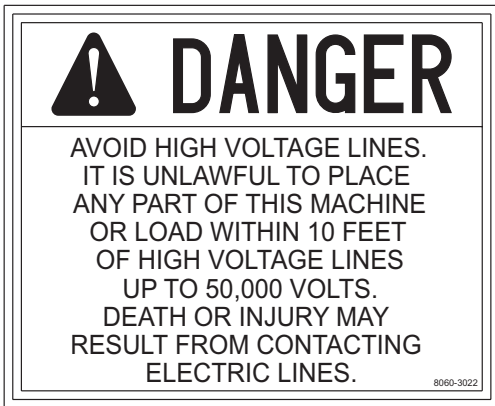

**Located on mud guard
P/N 8060-3022**

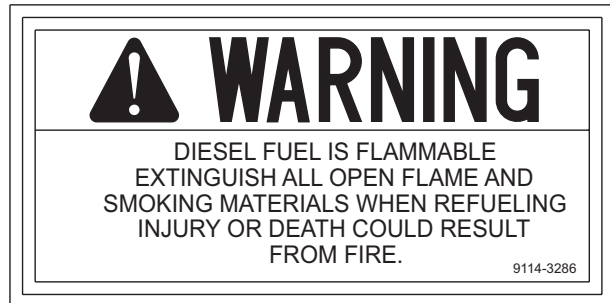

**Located on fuel tank
P/N 9114-3286**



**Located on boom
P/N 8060-3037**

2.5

OUTSIDE THE CAB

GRADALL HANDLER SERVICE INSTRUCTIONS FOR: 544D-10	SERVICE INTERVALS					TYPE OR EQUIVALENT
	DAILY OR 10 HRS	WEEKLY OR 50 HRS	EVERY 3RD OR 200 HRS	3 MO OR 500 HRS	6 MO OR 1000 HRS	
DIESEL ENGINE						
AIR CLEANER ELEMENTS			CHANGE			
FUEL FILTER			CHANGE			
OIL FILTER			CHANGE			
OIL (12 QT.)	CHECK FILL					SAE 15W-40 CD *** DIESEL FUEL #2
DIESEL FUEL (40 GAL.)						
HYDRAULIC SYSTEM						MOBIL 424
HYDRAULIC FILTER	CHECK		INSPECT		CHANGE	
AIR FILTER/CLIP			CHANGE			
AIR FILTER/CLIP CAP			CHANGE			
REAR AXLE			CHECK	CHANGE		MOBIL 424
WHEEL NUT TORQUE				TORQUE		
BATTERY & TERMINALS	CHECK					
RADIATOR						ETHYLENE GLYCOL ANTIFREEZE
3 GAL WATER			CHECK			
3 GAL ANTIFREEZE						62# LIQUID FILLED
TIRES: 14.00x24(12 PLY) 65 PSI						62# LIQUID FILLED
TIRES: RADIAL 70 PSI						62# LIQUID FILLED
CYLINDER FITTINGS EACH END						MYSTIK TETRAMOLY
REAR AXLE (12) FITTINGS						MYSTIK TETRAMOLY
FRONT AXLE PIVOT (2) FITTINGS						MYSTIK TETRAMOLY
ALL BEARINGS PADS						MYSTIK TETRAMOLY
FRONT BOTTOM BEARING PADS		GREASE	CHECK			MYSTIK TETRAMOLY
BOOM PIVOT (2) FITTINGS						MYSTIK TETRAMOLY
HEAD PIN (2) FITTINGS						MYSTIK TETRAMOLY
BOOM SHEAVES (5) FITTINGS						MYSTIK TETRAMOLY
QUICK SWITCH (1) FITTING						MYSTIK TETRAMOLY
RETRACT & EXTEND CHAIN TENSION SEE MANUAL FOR PROCEDURE				CHECK		
EXTEND CHAIN LUBE				LUBE		SCOTTS SILVER SHIMMER

THIS CHART MUST BE USED IN CONJUNCTION WITH SERVICE MANUAL AND RECOMMENDED PROCEDURE.

- * CHECK INDICATOR ON HYDRAULIC FILTER. CHANGE FILTER IF NEEDLE IS IN YELLOW AT FULL THROTTLE & AT OPERATING TEMPERATURE.
- ** CHECK AIR CLEANER RESTRICTION INDICATOR. CLEAN OR CHANGE PRIMARY FILTER IF NECESSARY. SAFETY ELEMENT TO BE CHANGED EVERY 3RD CHANGE OF PRIMARY FILTER ELEMENT.
- *** CONSULT DEALER FOR RECOMMENDATIONS AT EXTREME TEMPERATURES.
- **** DAILY SERVICE MAY BE REQUIRED FOR OPTIMUM LIFE DEPENDING UPON APPLICATION SEVERITY.

IT IS RECOMMENDED THAT FILTER ELEMENTS AND FRONT AXLE LUBRICANT BE CHANGED AFTER FIRST 50 HRS ON NEW OR REBUILT UNITS.

9136-3142 REV. D

Located on mudguard
P/N 9136-3142

⚠ WARNING

ATTACHMENT MUST BE SECURED TO MACHINE. CHECK TO ASSURE QUICK SWITCH PLUNGER PIN IS FULLY ENGAGED AND LOCKED AFTER ATTACHMENT CHANGE. IF PLUNGER PIN IS NOT FULLY ENGAGED AND LOCKED ATTACHMENT MAY FALL OFF CAUSING SERIOUS INJURY OR DEATH.

9114-3290

Located on boom head
P/N 9114-3290

⚠ WARNING

READ AND UNDERSTAND THE FOLLOWING PRIOR TO LIFTING PERSONNEL. WHEN LIFTING PERSONNEL USE ONLY A GRADALL MANUFACTURED PERSONNEL WORK PLATFORM. ALL PERSONNEL IN PLATFORM MUST WEAR A FULL BODY HARNESS WITH LANYARD ATTACHED TO A DESIGNATED ANCHORAGE POINT. READ AND UNDERSTAND PERSONNEL WORK PLATFORM USER'S MANUAL BEFORE OCCUPYING PERSONNEL WORK PLATFORM. FAILURE TO COMPLY COULD RESULT IN SERIOUS INJURY OR DEATH.

9055-3026 REV. A

Located on boom head
P/N 9055-3026

⚠ WARNING

READ AND UNDERSTAND THE FOLLOWING PRIOR TO LIFTING PERSONNEL. WHEN LIFTING PERSONNEL USE ONLY A GRADALL MANUFACTURED PERSONNEL WORK PLATFORM. DO NOT DRIVE MACHINE WITH PERSONNEL IN PLATFORM. WHEN PERSONNEL ARE IN PLATFORM REMAIN SEATED IN CAB WITH PERSONNEL IN DIRECT LINE OF SIGHT. OPERATE CONTROLS LIGHTLY AND CAUTIOUSLY WHEN LIFTING PERSONNEL. READ AND UNDERSTAND PERSONNEL WORK PLATFORM USER'S MANUAL BEFORE LIFTING PERSONNEL. DO NOT USE PERSONNEL WORK PLATFORM WITHOUT THE PROPER GRADALL MATERIAL HANDLER/PERSONNEL WORK PLATFORM CAPACITY CHART DISPLAYED IN CAB. FAILURE TO COMPLY COULD RESULT IN SERIOUS INJURY OR DEATH.

9055-3027 REV. A

Located on mudguard
P/N 9055-3027

ATTACH LANYARD HERE

9055-3032

Located on Personnel Work Platform
P/N 9055-3032

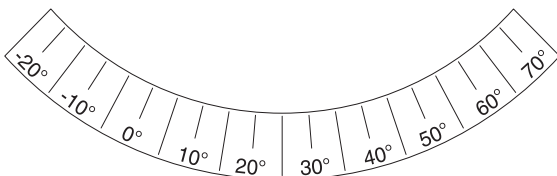

Located on left side of boom
P/N 9100-3031

⚠ WARNING

MAXIMUM OCCUPANCY THREE (3) PEOPLE. DO NOT USE PERSONNEL WORK PLATFORM WITHOUT THE PROPER GRADALL MATERIAL HANDLER/PERSONNEL WORK PLATFORM CAPACITY CHART DISPLAYED IN CAB. FAILURE TO COMPLY COULD RESULT IN SERIOUS INJURY OR DEATH.

9055-3031 REV. A

Located on Personnel Work Platform
P/N 9055-3031

GRADALL

406 MILL AVE. S.W. NEW PHILADELPHIA, OHIO MADE IN U.S.A.

ATTACHMENT

SERIAL NUMBER

WEIGHT

CAPACITY

HYD. PRESSURE

THE CAPACITY OF FORKLIFT ATTACHMENT AND FORK COMBINATION MAY BE LESS THAN THE CAPACITY SHOWN ON ATTACHMENT - CONSULT FORKLIFT NAMEPLATE AND ALSO INSURE FORKS ARE OF PROPER SIZE.

9015-3001

Located on attachment
P/N 9015-3001

GRADALL

406 MILL AVE. S.W. NEW PHILADELPHIA, OHIO MADE IN U.S.A.

ATTACHMENT

SERIAL NUMBER

WEIGHT

CAPACITY

HYD. PRESSURE

DO NOT USE PERSONNEL WORK PLATFORM WITHOUT THE PROPER GRADALL MATERIAL HANDLER/PERSONNEL WORK PLATFORM CAPACITY CHART DISPLAYED IN CAB.

9055-3033

Located on Personnel Work Platform
P/N 9055-3033

3.0 OPERATOR'S CAB

OPERATOR'S CAB

The standard cab permits vision from all sides and includes an overhead guard to provide protection from falling objects.

A fully-enclosed cab with windows and a lockable door is available as an option. The top half of the cab door must be secured in the fully-opened or closed position. The bottom half of the cab door can be secured in the closed position only. Be sure the door is fully secured when operating the handler.

The operator's seat is equipped with a seat belt and includes fore and aft adjustment to compensate for variations in operator size. The adjustment release/lock is located beneath front edge of seat. **Wear seat belt when operating machine.**

An optional windshield wiper/washer is available for use with enclosed cabs. A control switch is located on the instrument panel.

A variable-speed defroster fan is available for use with enclosed cabs. An "On/Off" control switch and speed control are located on the base of the fan.

A heater fan is available for use with units equipped with a heater. An "On/Off" switch is located on the dashboard. Hot water to the heater can be controlled by a valve at the engine.

The operator's cab is an S.A.E. "FOPS/ROPS" structure. Do not make any modification to this structure. If damaged, the cab cannot be repaired. It must be replaced.

CONTROL AND INSTRUMENT IDENTIFICATION

Figure 3-1

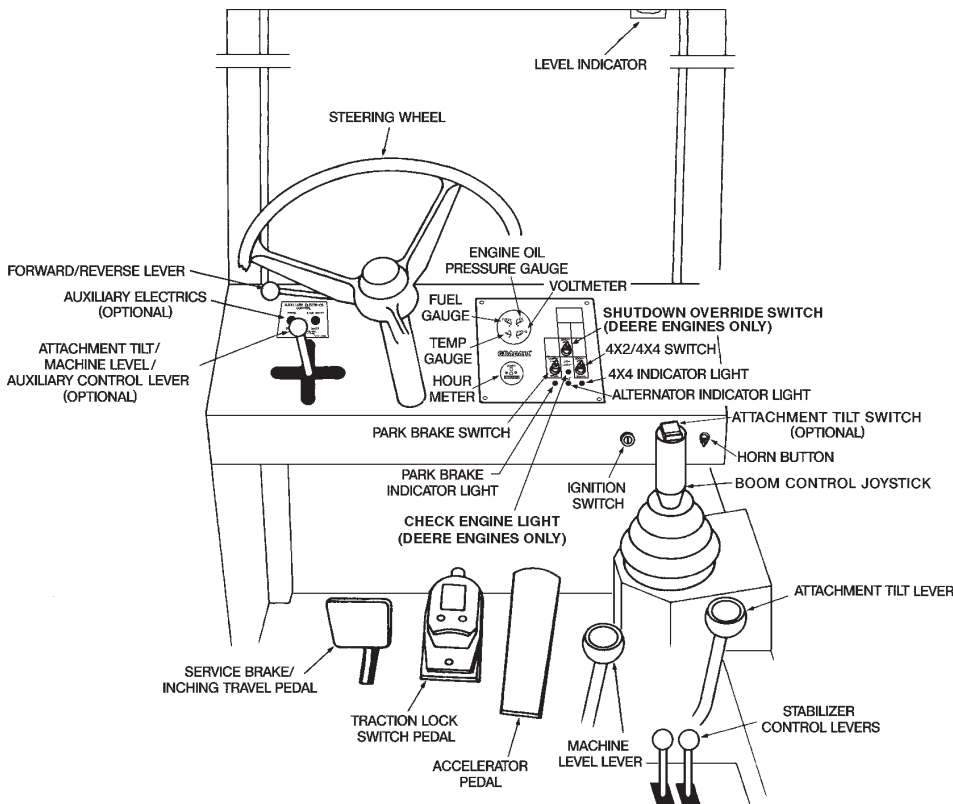

WARNING

Never operate the handler unless the overhead guard is in place and in good condition.

WARNING

Any modification to this machine must be approved by GRADALL to assure compliance with FOPS/ROPS certification for the cab/machine configuration.

NOTE!

*Relevant S.A.E. Recommended Practices:
S.A.E. J1040 for ROPS
S.A.E. J231 for FOPS*

3.1

Accelerator Pedal: Depress pedal to increase speed and release pedal to decrease speed.

Alternator Indicator Light: Glows (red) to indicate alternator is not charging.

Attachment Tilt Lever: This lever controls tilt of the fork carriage. Speed is proportional to lever actuation and engine RPM. Push lever forward to tilt down; pull lever back to tilt up.

Attachment Tilt Switch (optional): Depress front of switch to tilt down; depress rear of switch to tilt up.

Auxiliary Control Lever (optional): This lever is used to control optional hydraulic attachments. Follow decal instructions for lever/handler movements.

Auxiliary Light Switch (optional): This switch turns auxiliary lights on and off.

Boom Control Joystick: This joystick controls boom elevation and extension. Pull joystick back to raise boom; push joystick forward to lower boom. Move joystick to right to extend boom; move to left to retract boom. Speed of boom movement is proportional to joystick actuation and engine RPM.

Check Engine Light (Deere Engines Only): Glows (red) for 30 seconds before engine shuts down when a "Shutdown" fault is detected.

Engine Coolant Temperature Gauge: This gauge displays engine coolant temperature.

Engine Oil Pressure Gauge: This gauge displays engine oil pressure.

Forward/Reverse Lever: This lever engages forward or reverse travel. Lift & push lever fully forward for forward travel; Lift & pull lever fully backward for reverse travel. Move lever to centered position for "Neutral".

Fuel Gauge: This gauge displays level of fuel in fuel tank.

Heater Fan Switch (optional): This switch turns heater fan on and off.

Horn Button: Depress button to sound horn.

Hourmeter: This meter indicates total time of engine operation in hours and tenths of hours.

Ignition Switch: This switch is actuated by a key. In "ACC" or "RUN" position, voltage is available for all electrical functions. Full clockwise rotation to "START" engages starter motor. Counter-clockwise rotation to "OFF" stops engine and removes voltage from all electrical functions.

Level Indicator: This bubble level indicator enables the operator to determine the left to right level condition of the handler.

Lights Switch (optional): This switch controls optional lighting which may be provided with the handler.

Machine Level Lever: This lever controls the relationship of the handler frame to the front axle. Push the lever forward to tilt frame to left, pull lever back to tilt frame to right.

Parking Brake Switch: This switch controls the application and release of the parking brake.



A brief description of controls and instruments is provided here as a convenience for the operator. These descriptions DO NOT provide complete operation instructions. Read & understand this Manual and the GRADALL Material Handler Safety Manual.

3.2

Parking Brake Indicator Light: Glows (red) to indicate brake is applied.

Rotating Beacon Switch (optional): This switch controls operation of rotating beacon.

Seat Lock Release Lever: This lever unlocks and locks seat position adjustment.

Service Brake/Inching Travel Pedal: This pedal operates the service brakes on the front axle. It also permits slow travel speed while engine speed is kept high for other handler functions. The further the pedal is depressed, the slower the travel speed. Full depression of pedal causes full service brake application.

Shutdown Override Switch (Deere Engines Only): The operator may delay a shutdown for 30 seconds by pushing the "Shutdown Override" switch. The switch resets the shutdown timer to 30 seconds and may be used repeatedly. However, continuously holding the "Shutdown Override" switch will not reset the 30 second timer.

Stabilizer Control Levers: Left lever controls left stabilizer; right lever controls right stabilizer. Push levers forward to lower stabilizers; pull levers back to raise stabilizers.

Starting Aid Switch (optional on Cummins Engines): This switch engages and disengages the cold-weather starting aid.

Steering Wheel: The steering wheel controls the angle of rear wheels. Turning the steering wheel to the right causes a right turn by angling rear wheels to left. A left turn is caused by angling rear wheels to right.

Traction-Lock Pedal: This pedal operates traction-lock valve which functions to restore traction when a wheel spins in four-wheel drive.

Voltmeter: This gauge indicates alternator output and battery condition.

4x2/4x4 Switch: This switch engages and disengages rear-wheel drive motors. Rear drive motors are engaged for four-wheel drive.

4x4 Indicator Light: Glows (amber) to indicate four-wheel drive is engaged. When park brake is applied, this light will not glow.

4.0 CHECKS & SERVICES BEFORE STARTING ENGINE

To be performed at the beginning of each work shift.

- If spark arrestors are required, be sure they are in place and in good working order.
- Check to be certain that windows and mirror(s) are clean and undamaged. Also make certain that mirror(s) are properly adjusted for operator's view.
- Before removing filler caps or fill plugs, wipe all dirt and grease away from the ports. If dirt enters these ports, it can severely reduce component life.
- When adding fluids, refer to lubrication section of Manual to determine proper type.

Complete all required maintenance before operating unit.



Service the unit in accordance with the "**Lubrication and Routine Maintenance**" schedule.



Inspect all structural members, including attachment, for signs of damage.



Inspect unit for obvious damage, vandalism and necessary maintenance. Check for signs of fuel, lubricant, coolant and hydraulic leaks. Open all access doors and look for loose fittings, clamps, components and attaching hardware. Replace hydraulic lines that are cracked, brittle, cut or which show signs of leakage or abrasion.

WARNING

Use extreme caution when checking items beyond your normal reach. Use an approved safety ladder.

WARNING

Before operating handler, complete all required maintenance. Replace or repair all damaged, worn or missing components before starting or operating handler. Failure to properly maintain handler could cause serious injury or death.

WARNING

*Use a piece of cardboard or paper to search for leaks. **DO NOT** use bare hands. If anyone is injured by hydraulic fluid, including penetration into the skin, obtain medical help **immediately!***

5.0 WARM-UP & OPERATIONAL CHECKS

To be performed at beginning of each work shift.

The safety, efficiency and service life of your handler will be increased by performing the operational checks listed below. If any of the items in the following checks are not operating properly, have them repaired prior to the machine being placed into service. Items preceded by an asterisk (*) are optional and may not be furnished on a standard machine.

Before entering the operator's cab, check:

1. Air Filter Restriction Indicator. If needle is in red area, filter is clogged and element must be changed.

During warm-up period, check:

- * 2. Heater, defroster and windshield wiper.
- * 3. Operating lights and rotating beacon.
4. Voltmeter - should show 13.5 to 14 volts.

When engine warms to operating range, check:

5. Service brake and parking brake.
6. Forward and reverse travel.
7. Steering (stop to stop in both directions) with engine at low idle.
8. "Inching" travel-should be smooth through full pedal travel.
9. Horn and back-up alarm.
10. All boom and attachment functions - operate fully and correctly.
11. Hydraulic level sight gauge, level handler, retract all cylinders and check sight gauge for hydraulic fluid level - refill as required.
12. Hydraulic Filter Condition Indicator - observe engine coolant temperature gauge after starting normal operation. When needle has been in operating range for an hour or so, stop handler in a safe area, apply parking brake, lower attachment fully, shift forward/reverse lever to "Neutral" position and block wheels. With engine running at full throttle, have an assistant check the Hydraulic Filter Condition Indicator. When needle is in red area, filter is clogged and hydraulic oil is bypassing filter. Filter element must be changed before needle reaches red area.

Complete all required maintenance before operating unit.



Continued operation with hydraulic fluid bypassing the filter may cause severe damage to hydraulic system components.

6.0 ENGINE OPERATION

Starting the Engine

1. Make sure all controls are in "Neutral" and all electrical components (lights, heater, defroster, etc.) are turned off. Set parking brake.
2. Depress accelerator pedal approximately 1/4 to 1/3 of travel from top.
3. Turn ignition switch to "START" to engage starting motor. Release key immediately when engine starts. If engine fails to start within 20 seconds, release key and allow starting motor to cool for a few minutes before trying again.
4. After engine starts, observe oil pressure gauge. If gauge remains on zero for more than ten seconds, stop engine and determine cause. Correct malfunction before restarting engine. Minimum pressure at operating temperature:
Low idle: 10 PSI (69kPa)
5. Warm up engine at approximately 1/2 throttle until engine coolant temperature reaches operating range.

Cold-Weather Starting Aids

In cold weather situations, a supplemental starting aid may be required. Gradall-approved starting aids employ ether. If your handler is equipped with an ether starting aid, the following applies:

Cummins Engine

- Hold switch on for 3 seconds to fill valve.
- Release switch to discharge ether while cranking engine.
- As engine starts, use additional ether as required to keep engine running.

Deere Engine

- Ether application is triggered by temperature gauge located on engine.
- At start-up, temperature gauge on engine will detect if ether is needed. Follow normal start-up procedure, shown above.
- Ether is employed and additional will be released if needed, to keep engine running.
- A second battery is added for additional cold-cranking capacity.

Battery-Boosted Starting

If you ever have to battery-boost start (jump-start) your handler, proceed as follows:

- Never allow vehicles to touch
- Connect the positive (+) jumper cable to positive (+) post of discharged battery
- Connect opposite end of positive (+) jumper cable to positive (+) post of booster battery
- Connect the negative (-) jumper cable to negative (-) post on booster battery
- Connect opposite end of negative (-) jumper cable to ground point on machine away from discharged battery
- Follow standard starting procedures
- Remove cables in reverse order after machine has started

WARNING

Operator must be seated with seat belt fastened, forward/reverse lever in "Neutral" position, parking brake applied and all hydraulic controls in "Neutral" before starting engine.

CAUTION

Turning ignition switch to "START" position while engine flywheel is rotating may cause serious damage to engine and/or starting motor.

NOTE!

Engine will not start unless forward/reverse lever is in "Neutral" and parking brake switch is applied.

CAUTION

If you use a starting aid employing ether or a similar substance, pay particular attention to manufacturer's warnings. Excessive ether may cause severe engine damage.

6.1

Normal Engine Operation

Observe gauges frequently to be sure all engine systems are functioning properly.

The voltmeter shows the "charge/discharge" state of the battery charging system. With the engine running, meter should indicate 13.5 to 14 volts. With engine stopped, meter indicates battery charge (12 volts). The alternator indicator light glows (red) to indicate alternator is not charging.

Be alert for unusual noises or vibration. When an unusual condition is noticed, park machine in safe position and perform standard shut-down procedure. **See Page 1.1.** Report condition to your supervisor or maintenance personnel.

Avoid prolonged idling. Idling causes engine temperature to drop and this permits formation of heavy carbon deposits and dilution of lubricating oil by incompletely-burned fuel. If the engine is not being used, turn it off.

Stopping the Engine

- **To stop engine, perform standard shut-down procedure.**
- **Operate engine at low idle for 3 to 5 minutes before turning it off.**
This allows engine coolant and lubricating oil to carry excessive heat away from critical engine areas, including turbocharger.
- **Do not "gun" engine before shut down:** This practice causes incompletely-burned fuel to remove oil film from cylinder walls and dilute lubricant in crankcase.

John Deere Engine Shut-Down Protection Feature

The feature monitors coolant temperature, oil pressure and charge-air temperature. If any of the listed items cause a fault in the system the check engine light will illuminate and the engine will shut down after 30 seconds. Within that 30 second period, lower the boom and apply parking brake. Report condition to your supervisor or maintenance personnel.

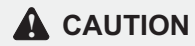

Always keep engine cover closed while engine is running.

NOTE!

In the event of needing to delay a shutdown, See "Shutdown Override Switch," Page 3.2.

NOTE!

In the event of engine or hydraulic failure, parking brakes can be released for towing. See "To Release Parking Brake," Page 16.1.

7.0 BRAKE SYSTEM

General

The brake system includes a service brake and a parking brake. Service and parking brakes are applied through wet disc brake packs located within axle housing.

Because service braking and "inching" (slow travel) functions overlap, some features of inching will be discussed here. **See "Drive Train" Section, Page 10.0**, for additional information on inching travel. **(See Figure 3-1 for layout of controls)**

Inching Travel

Overlap between braking and inching occurs because the same pedal controls both functions; also because both functions control travel speed. However, the methods of controlling travel speed are quite different. Service braking involves a controlled stopping force applied to the front wheels. Inching involves a controlled driving force applied to the driving wheels.

Figure 7-1

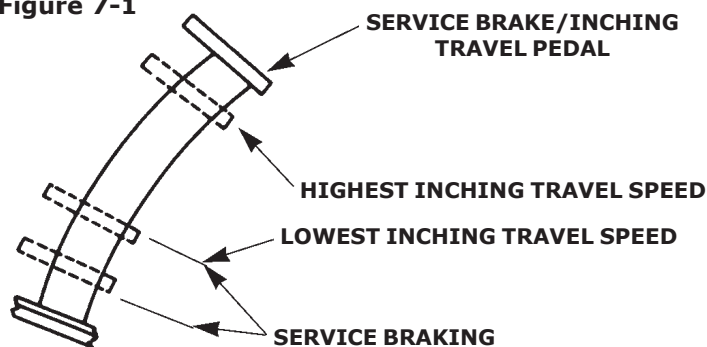

Most of the inching travel pedal stroke controls the speed of inching travel. As the pedal nears the bottom of its stroke, service brakes are engaged.

Service Brakes

Depressing service brake/inching travel pedal to braking portion of pedal travel causes controlled hydraulic pressure to be applied to service brakes. The greater the pedal travel, the greater the braking force.

If power-assist fails, it will require much greater force on pedal to apply brake, and stopping distance will be greater.

Parking Brakes

The parking brakes are spring-applied and hydraulically-released.

Hydraulic power to release parking brakes is provided by the hydraulic system and is controlled by the parking brake switch located on the dashboard.

With the engine running and the parking brake switch "Off," parking brakes are disengaged. Moving the switch to "On" releases hydraulic pressure to apply the parking brakes. With switch in "ON" position, four-wheel drive is disabled.

WARNING

Practice inching/braking in a safe, open area until you are thoroughly familiar with handler response.

WARNING

*If power-assist feature should fail for any reason, it would require greater effort to apply service brake. **It is extremely important that you never stop the engine while traveling.** If power assist fails, stop as soon as possible. Do not drive the handler until problem has been corrected.*

WARNING

Always move parking brake switch to "On" position before leaving cab.

Never stop engine while traveling. Parking brake will be fully-applied and unit may stop abruptly. A sudden stop could cause load loss.

NOTE!

*In the event of engine or hydraulic failure, parking brakes can be released for towing. **See "To Release Parking Brake," Page 16.1.***

8.0 PARKING THE HANDLER

Precautions

- Avoid parking on slopes or near an excavation.
- Park on level ground and chock wheels.
- Avoid parking on roads or highways. If it cannot be avoided, be sure to display warning flags during day and flares or flashing lights at night.
- Position boom-head or attachment on ground; never leave machine with boom in air.
- If parking on a slope cannot be avoided, position the handler at a right angle across the slope, straighten rear wheels and chock all wheels.

Parking procedure

1. Using service brake, stop the handler in an appropriate parking area.
2. Move parking brake switch to "On."
3. Shift forward/reverse lever to "Neutral."
4. Position attachment on ground.
5. Allow engine to cool at idle speed for 3 to 5 minutes, stop engine and remove ignition key.
6. Chock wheels as an extra precaution against rolling.
7. Fill fuel tank to minimize condensation.
8. Lock cab and install protective covers, if so-equipped.
9. Disconnect batteries if unit is in an area where tampering is a risk.

9.0 STEERING SYSTEM

- Rear-wheel power steering is provided to reduce operator fatigue and to permit high maneuverability in close quarters.
- It is imperative that the operator practice maneuvering the handler in a safe, open area to become thoroughly familiar with steering response and clearance required for tail swing and load when turning.



Be alert for any increase in effort needed to steer. If any difference is noted, notify maintenance personnel immediately. If power assist feature should fail for any reason, IT WOULD BECOME VERY DIFFICULT TO STEER. For this reason it is extremely important that you NEVER TURN ENGINE OFF WHILE TRAVELING.

In the event power steering fails, stop as soon as possible. Do not drive handler until problem has been corrected.

10.0 DRIVE TRAIN

General

The Material Handler covered by this Manual is equipped with hydrostatic drive. From the operator's standpoint, operation is similar to driving a vehicle equipped with an automatic transmission.

Major components of the system include a front drive axle with a differential and planetaries. The differential receives torque from a variable-displacement piston pump and a motor.

This combination of components eliminates the need for a conventional mechanical transmission and also provides inching travel.

These handlers also have piston motors to provide torque to rear-wheel drive hubs, as well as an electrically-controlled valve which functions to restore tractive effort if conditions cause a wheel to spin.

Operation

Normal Travel. Direction of travel is selected by moving forward/reverse lever forward for forward travel, backward for reverse travel. Move lever to center position for "Neutral". *(See Figure 3-1 for layout of controls)*

If hydrostatic drive system senses increased travel load, the system will compensate automatically by reducing travel speed to match load and engine RPM.

Inching Travel: Inching travel is provided to permit slow travel speed while maintaining high engine speed for other handler functions.

The service brake/inching travel pedal controls inching travel.

The upper portion of pedal travel actuates a valve which controls travel pump output. The greater the pedal travel, the less the pump flow; the slower the travel.

The lower portion of pedal travel actuates the service brake. The greater the pedal travel, the stronger the brake application. Travel flow is further reduced when brakes begin to apply. *(See Figure 7-1)*

Four-Wheel Drive: When required by travel conditions, rear-wheel (four-wheel) drive can be engaged by moving switch to "4x4" position. Return unit to two-wheel drive by moving switch to "4x2" position.

Four-wheel drive can be engaged and disengaged while traveling.

When parking brake is applied, four-wheel drive is disabled.

Traction-Lock Switch: This switch (pedal) controls the traction-lock valve which functions to restore tractive effort when a wheel spins in four-wheel drive.

When switch pedal is depressed and held, traction-lock valve functions to cause delivery of full drive pressure to wheels of other axle, regardless of low pressure at spinning wheel.

DO NOT engage traction-lock function on improved surfaces. Unit must be in four-wheel drive to engage the traction-lock function.

DO NOT engage traction-lock function while wheels are turning. Return engine to idle, engage traction-lock and increase RPM. Disengage after traction resumes while in motion.



Bring handler to a complete stop before shifting forward/reverse lever when carrying a load. A sudden change in direction of travel could reduce stability and/or cause load to shift or fall.



Practice inching/braking in a safe, open area until you are thoroughly familiar with response of machine to pedal travel.



Never disengage rear hubs except when activating tow-bypass procedure.

11.0 LEVELING THE HANDLER

“Leveling” means positioning the handler so that it is level from side to side (left to right).

A level indicator is located in the upper right corner of front window frame to permit operator to determine whether handler frame level. **(See Figure 3-1)**

There are four very important things to remember about handler leveling:

1. Never engage a load or lift a load more than four feet (1.2m) above ground unless handler is level.
2. A handler with the boom raised and/or an attachment installed is a partially-loaded handler.
3. Once the handler frame is level and the handler has raised a load more than four feet (1.2m) above ground, it must not be moved from this position if such movement could change the level condition. Do not use sway to level handler with load more than four feet (1.2m) above ground.
4. The combination of side tilt and load can cause the handler to tip over.

Two ways to level the handler with stabilizers up :

The surface which will support the handler can be leveled. This method must be chosen if it will be necessary to move the handler from its position after the load has been raised over four feet (1.2m) from ground AND such movement could change the level condition.

Remember: The supporting surface must be large enough, smooth enough and firm enough to keep the handler level when it is moved from its position.

The handler may be leveled by means of the frame-leveling system. This method may be chosen when it will not be necessary to move the handler from its position after the load has been raised above four feet (1.2m) from ground - OR - when such movement will not change the level condition of the handler.

Always determine best position for handler to raise load from its present location and also to position load at its destination. **THEN** determine which method of leveling will be required at each location.

FINALLY, consider terrain between present location of load and its destination. Never attempt to transport a load across terrain which could cause handler to tip over.

Leveling Handler Frame:

The handler is designed to permit tilting main frame 8° to left or right to compensate for uneven ground conditions.

The rear axle pivots at the midpoint of the main frame to help ensure that all wheels will remain in contact with the ground.

A hydraulic cylinder provides a rigid connection between front axle and main frame to help ensure a solid work platform and to tilt main frame to left or right.

The 544D-10 is equipped with rear-axle stabilization. This system includes a hydraulic cylinder attached between the frame and the rear axle, as well as flow-restricting valving. This system dampens rear-axle oscillation whenever the boom is raised over 40° from level. **However, the system never locks the rear axle and is not designed to increase lateral stability.**

WARNING

Raising the boom (loaded or unloaded) when handler is leaning to one side could cause machine to tip over with little or no warning and cause serious injury or death.

WARNING

Always move boom to carry position (horizontal or below) before leveling frame. Attempting to level machine with boom raised could cause it to tip over.

11.1

Leveling Procedure:

1. Position machine in best location to lift or place load and apply parking brake.
2. Observe level indicator to determine whether machine must be leveled. Note position of indicator for later realignment.
3. If necessary to level handler, position boom in carry position and level machine with the lever.
4. Lift or place load as appropriate.
5. Retract and lower boom to carry position.
6. Realign frame to position noted in step 2.

Frame-Leveling Controls

Figure 11-1

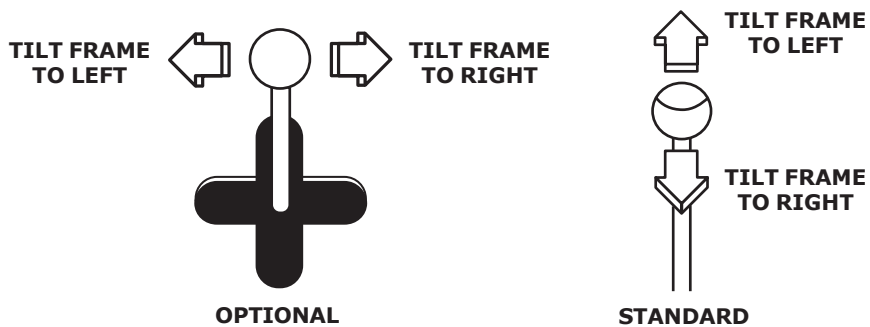

If handler cannot be leveled using leveling system, do not attempt to raise or place load. Have surface leveled.

12.0 OPERATING PROCEDURE & TECHNIQUES

Hydraulic Controls

All boom and attachment movements are governed by hydraulic controls. Rapid, jerky operation of hydraulic controls will cause rapid, jerky movement of the load. Such movements can cause the load to shift or fall or may cause the machine to tip over.

Feathering

Feathering is a control operation technique used for smooth operation. To feather controls, move control lever very slowly until function begins to move, then gradually move lever further until function is moving at desired speed. Gradually move lever toward "Neutral" as load approaches destination. Continue to reduce load speed to bring load to a smooth stop. Feathering effect can be increased by reducing engine speed at beginning and near end of load movement.

Boom Control Joystick

The boom control joystick can be positioned to activate individual boom movements or combinations of boom movements as illustrated:

Figure 12-1

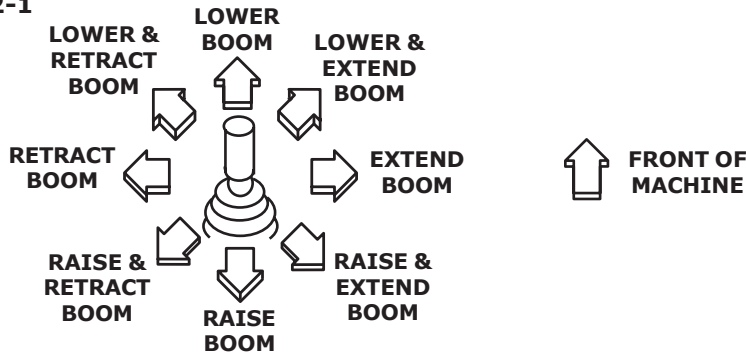

With boom raised above horizontal, forks can be inserted under a load by moving boom control joystick forward and to the right until forks move forward horizontally.

With boom raised above horizontal, forks can be removed from a load by moving boom control joystick back and to the left until forks move rearward horizontally.

With boom lowered below horizontal, forks can be inserted under a load by moving boom control joystick back and to the right until forks move forward horizontally.

With boom lowered below horizontal, forks can be removed from a load by moving boom control joystick forward and to the left until forks move rearward horizontally.

The closer the boom to horizontal, the less boom raise/lower movement required for inserting and removing forks.

Carriage Tilt Controls

Figure 12-2

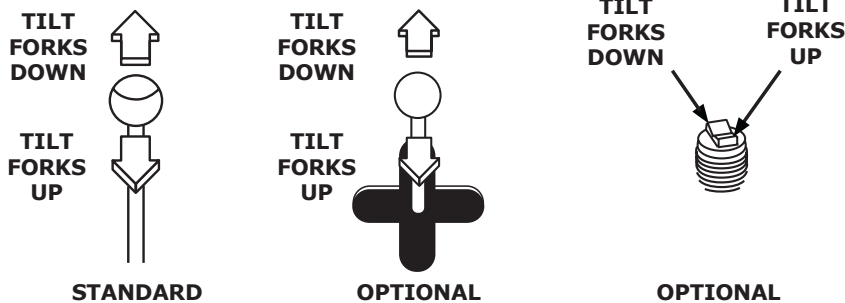

NOTE!

Much of the material in this section may be new to even the experienced operator.



Do not permit lift cylinders to hit the end of their stroke. The jolt could topple loads, causing a hazard to personnel and equipment nearby.

12.1

Rated Capacity Chart

The rated capacity chart, located on dashboard, indicates maximum load capacities for handlers equipped with GRADALL-furnished carriage/fork combination. These capacities apply to standard carriage/fork combinations except as stated on the capacity chart.

Figure 12-3

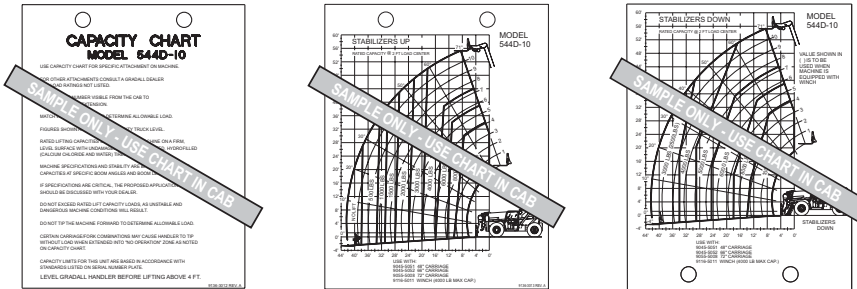

All loads shown on rated capacity chart are based on machine being on firm, level ground; the forks being positioned evenly on carriage; the load being centered on forks; proper size tires being properly inflated; and the handler being in good operating condition.

Elevation:

Numbers at left side of sample chart represent elevation to top of horizontal fork as measured from level ground (in feet). Elevation relates to dimension "A" shown on serial number plate, inside cab, front right side.

Boom Extension

Numbers across bottom of sample chart and numbers parallel to boom represent boom reach as measured from front of front tires to extended position.

Number decals on boom relate directly to boom extension. The largest number which can be read from operator's seat indicates total boom extension and must be matched with boom angle to determine load capacity.

Boom extension relates to dimension "D" shown on serial number plate.

Boom Angle

Numbers shown at ends of angled lines represent angle of boom to horizontal as measured from horizontal. Maximum angles are -4° below horizontal with boom fully lowered to 71° above horizontal with boom fully raised.

A boom angle indicator is located on left side of boom-section 1 to show boom angle. **Be sure machine is level from front to rear or indicator will provide incorrect reading.**

Load Center

Loads shown on rated capacity chart are based on the load center being two feet (610mm) above the horizontal surface and two feet (610mm) forward of the vertical surface of the forks.

The load center of a load is the center of gravity of the load. For regularly-shaped loads of the same material, such as a pallet of blocks, the center of gravity can be located by measuring the load to find its center. For irregular loads, or loads of dissimilar materials, keep the heaviest part of the load as close to the heel of the forks as possible.

In all cases, the load center must be centered between the forks.

Load Limits

Some capacities shown on the rated capacity chart are based on machine stability and some are based on hydraulic lift capacity. The "common sense" or "feel" an experienced operator might apply in regard to "tipping loads" **DOES NOT APPLY** to hydraulic load limits. Exceeding load limits can cause damage, or, in some cases, cause the machine to tip over.

12.2

Items needed to Use a Capacity Chart

There are five items you must know and/or have in order to properly use a Capacity Chart:

1. The weight of the load to be lifted
2. The angle of the boom
3. How much boom extension will be needed
4. The proper Capacity Chart
5. A Gradall-approved Attachment

Every Gradall attachment comes with its own Identification Plate. This Plate has the Attachment Serial Number, Part Number, Attachment Capacity and Attachment Weight stamped on it. Make sure that the Capacity Chart you are using matches the attachment exactly. This may be done by matching the attachment part number on the Capacity Chart to the part number stamped on the Identification Plate. The Machine Serial Number Plate is mounted inside the cab and lists all standard attachments that may be used with the machine by part number, at the time it was shipped from the factory. Be aware that a specific Capacity Chart must not only match the attachment, but also the machine model.

The boom angle can be determined by looking at the angle indicator mounted on the side of the boom. **(See figure 12-4)**

The boom extension can be determined by looking at the second boom section. As the second boom section slides out of the main boom, numbers are revealed starting with 1. Each number represents approximately 5 feet of total boom extension. **(See figure 12-4) It is important to remember that these numbers are designed to be read from the operator's seat only!**

How to read a Capacity Chart

When reading the capacity chart you must check to be sure the correct model number is listed. **(See figure 12-5)** The next thing to look for is that the part number of your attachment is listed under the "Use With" section.

Identify and find the amount of boom extension required, along with the angle of the boom. Trace the boom extension arc down until it intersects with the appropriate boom angle. If the intersection of the boom extension arc and the boom angle line occur within a weight region, the value within that region is the maximum capacity for that particular lift. If the intersection occurs on a bold line separating capacity regions, the smaller of the two values must be used. The regions are clearly marked with heavier outlines as shown on page 12.3. If you do not have the correct capacity chart for your machine and/or attachment, contact your Distributor or Gradall to order one.

Example:

A contractor has purchased a 544D-10 with the 48" Slope Piler Carriage Attachment. **(See figure 12-5)** He knows his attachment may be used with this model since the attachment part number, 9108-5058, matches the attachment part number stamped on the machine Serial Number Plate. He also knows that the Capacity Chart is correct since it is clearly marked for use with a 544D-10 and that the attachment he is using is listed at the top by part number. He has determined the weight of the load to be lifted is 4000 lbs. and that he needs to place the load at a boom extension of 6 at a boom angle of 20°. By tracing the boom extension arc down to where the 20° line intersects it, the contractor can see that the maximum weight he can lift, with stabilizers down, is 5000 lbs. In this case, he may lift the load.

NOTE!

Some attachments may not be approved for use with certain machine models.

12.3

Figure 12-4
Where to look on the machine.

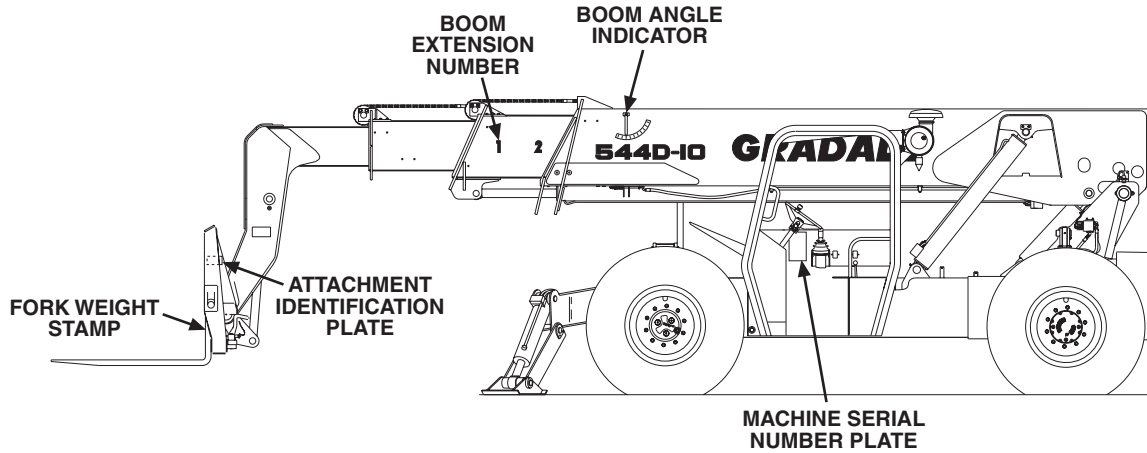
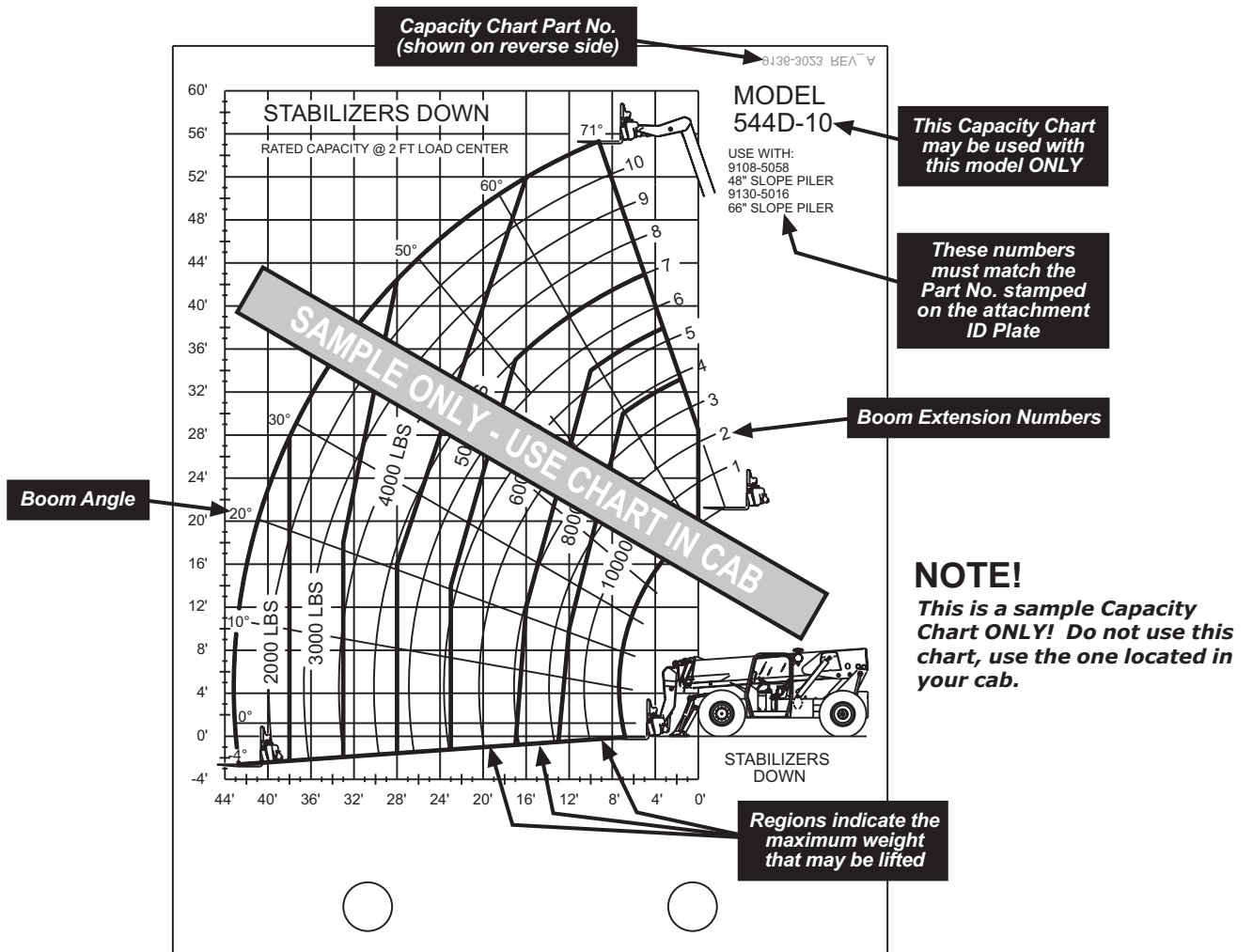

Figure 12-5
Description of items on a Capacity Chart.



13.0 ATTACHMENTS

Approved Attachments

Although the carriage/fork combination is most frequently used, several other GRADALL-approved attachments are available for use with your material handler. Contact your GRADALL Material Handler Distributor for information on approved attachments designed to solve special material handling problems.

The serial number plate lists attachments approved for use with your handler. However, there may be additional approved attachments available. Contact your GRADALL Material Handler Distributor for further information.

Non-Approved Attachments

Do not use non-approved attachments for the following reasons:

- GRADALL cannot establish range and capacity limitations for “will fit,” homemade, altered, or other non-approved attachments.
- An overextended or overloaded handler can tip over with little or no warning and cause serious injury or death to the operator and/or those working near the handler.
- GRADALL cannot assure the ability of a non-approved attachment to perform its intended function safely.
- Non-approved attachments may cause structural or other damage to the handler. Such damage could cause dangerous operating conditions resulting in serious injury or death.

Carriage/Fork Capacities

The standard carriage/fork capacity chart (located on the dashboard) indicates maximum reach and load capacities for handlers equipped with an approved carriage/fork combination. **These limitations apply to standard, GRADALL-approved carriage/fork combinations, except as stated on the capacity chart.**

Non-standard carriage/fork combinations (greater or lesser capacity) may be furnished by GRADALL at customer’s request or may be available for installation because they were furnished for a different application.

If a carriage/fork combination of lesser capacity is used, **the overall machine capacity is reduced** to the capacity stamped on the carriage or forks, whichever is less.

If a carriage/fork combination of greater capacity is used, the overall machine capacity may be reduced because of additional attachment weight and/or other considerations. **Contact your local GRADALL Distributor to determine capacity limitations.**

Other Attachment Capacities

A serial number/capacity plate is attached to all GRADALL-furnished attachments. **Do not assume that any GRADALL attachment may be used on any GRADALL Material Handler.**

First, check the listing of approved attachments on handler serial number plate. If the attachment in question is not included in the list, contact your local GRADALL Distributor to check whether or not the attachment is approved.

Next, **if the attachment is approved for use** with your handler, compare maximum capacity from attachment serial number plate and value stamped on forks to maximum capacity for that **attachment** as indicated on material handler serial number plate. **The smallest of these values is correct for your handler.**



Attachments which have not been approved for the use with your handler could cause machine damage or an accident resulting in injury or death.

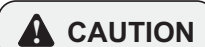

The capacity of forklift, attachment and fork combination may be less than the capacity shown on attachment. Consult forklift nameplate and also ensure forks are of proper size.

Forks rated less than the attachment capacity decrease capacity of attachment to that of forks. Forks rated more than attachment capacity do not increase attachment capacity.



Never use an attachment without the appropriate, GRADALL supplied capacity chart for that particular attachment installed in the handler.

13.1

Attachment Installation



1. Retract Quick Switch™ (attachment tilt lever forward) to provide clearance. Check to be sure lock pin is secured in out position with retainer pin.



2. Align boom head pivot with recess in attachment. Raise boom slightly to engage boom head pivot in recess.



3. Engage Quick Switch™ (attachment tilt lever backward).



4. Remove retainer pin and slide lock pin in fully.



5. Secure lock pin in locked position using retainer pin.



6. If attachment is equipped, swing saddles down and pin in place.

WARNING

This installation procedure is designed for one-man operation. If a helper is involved, shut off the engine before proceeding to steps 4, 5, and 6.

WARNING

Always be certain that carriage or attachment is properly positioned on boom head and is secured by lock pin and retainer pin. Failure to ensure proper installation could permit carriage/attachment/load to disengage and cause serious injury or death.

Attachment Operation

Operation of the handler equipped with carriage/fork combination is covered in the **GRADALL Material Handler Safety Manual and this Manual.**

Operation of the handler when equipped with other approved attachments is covered in this section or in separate instructions furnished with the attachment. Any separate instructions must be kept in Manual Holder in cab with this **Owner/Operator Manual.**

Operate a handler equipped with an attachment as a partially-loaded handler. Pay special attention to capacity and range limits for the handler/attachment combination.

Practice operation of handler and attachment in a safe, open area, not hazardous to yourself, other persons, equipment or property. Become thoroughly familiar with response of handler and attachment to controls before operating in a work situation.

Always consider terrain between present location of load and delivery point. Never attempt to transport a load across terrain which could cause handler to tip over.

13.2

Fork Positioner

Capacity:

Maximum load capacity for fork positioner carriage is the same as standard carriage without fork positioner. **Refer to Attachment Capacity Chart.** Capacity varies with boom extension and elevation positions.

Controls:

Figure 13-1

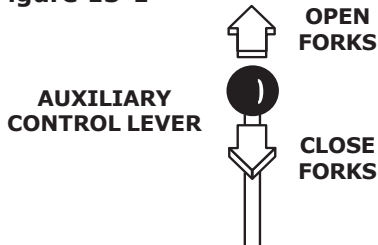

The auxiliary control lever is used to adjust fork position. Pull lever back to close forks, push lever forward to open forks.

Installation Procedure:

1. Remove standard carriage/fork combination or other attachment from boom head. **(See "Attachment Installation" Page 13.1)**
2. Install carriage/fork combination with positioner.
3. Connect auxiliary hydraulic hoses to positioner cylinders.

Operation:

- Always adjust fork position before engaging load. Moving forks after engaging load could cause load to fall from forks.

Light Material Bucket

Capacity:

Maximum capacity of light material bucket is shown on the attachment serial number plate and may be used in areas where it does not exceed capacities shown on standard carriage/fork capacity chart. Capacity must be reduced for areas where maximum bucket capacity would exceed standard carriage/fork capacity chart.

Attachment Tilt Controls:

Figure 13-2

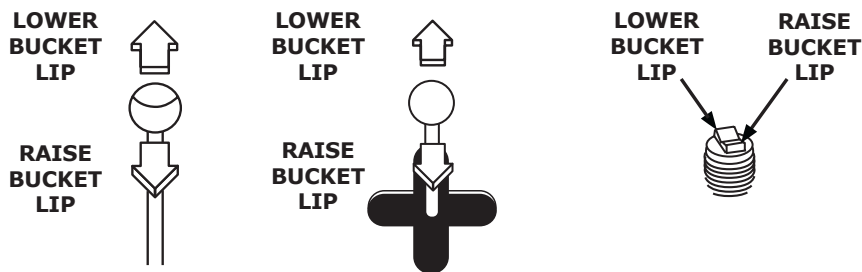

Because the carriage tilt cylinder is used to tilt the bucket, the carriage tilt lever is used to control the bucket. Pull lever back to raise bucket lip push lever forward to lower bucket lip.

Installation Procedure:

1. Remove carriage/fork combination or other attachment from boom head. **(See Page 13.1)**
2. Install light material bucket on boom head.
3. Retract boom fully and tilt bucket up or down as required to position bottom of bucket parallel with ground.



WARNING

PRECAUTIONS

- Always adjust fork position before engaging load.
- As with all other attachments, handler must be level before handling a load more than four feet (1.2m) above ground level. **(See "Leveling The Handler," page 11.0)**



WARNING

Observe all precautions and load capacity limits (listed previously) when handling loads with carriage/fork positioner.



WARNING

PRECAUTIONS

- Handler must be level before handling a load more than four feet (1.2m) above ground level. **(See Page 11.0)**
- Retract boom fully before loading bucket. Loading bucket with boom extended could damage structural members or extension chains/cables.
- Avoid shock loads; drive into stockpile smoothly to load bucket.
- Do not use bucket as a lever to pry heavy material. Excessive prying forces could damage the bucket.
- Do not use bucket for "back dragging." This could cause severe damage to Quick Switch fittings.



WARNING

Observe all precautions and load capacity limits (listed previously) when handling loads with light material bucket.

13.3

Operation:

- Raise or lower boom to appropriate height for loading material from stockpile.
- Align handler with face of stockpile and drive slowly and smoothly into pile to load bucket. Do not corner-load bucket.
- Tilt bucket up far enough to retain load and back away from pile.
- Lower bucket to carry position 4 feet (1.2m) or less above ground and travel carefully to unloading point. Turn bucket down to dump load.

Mast (6' [1.8m] with 4' [1.2m] or 6' [1.8m] carriage)

Capacity:

Maximum lift capacity (indicated on attachment serial number plate) applies only to certain areas within boom extension/elevation pattern of handler/mast combination. A separate capacity chart must be used for handlers equipped with mast. Study and understand this chart before attempting to handle a load with mast attachment.

Attachment Tilt Controls:

Figure 13-3

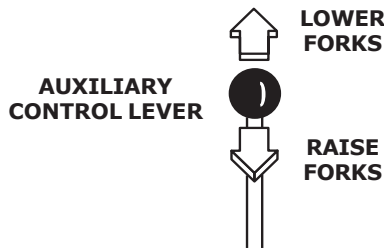

The carriage tilt cylinder is used to tilt the mast and the carriage tilt lever controls mast tilt. The auxiliary control lever is used to raise and lower the forks in the mast. Pull lever back to raise forks; push lever forward to lower forks.

Installation Procedure:

1. Remove carriage/fork combination or other attachment from boom head. (See Page 13.1)
2. Install mast on boom head.
3. Connect auxiliary hydraulic hoses to mast cylinder.

Operation:

- Always level handler before raising the boom or the forks, with or without a load.
- To travel with a load, lower forks fully in mast and lower boom to position load 4 feet (1.2m) or less above ground, allowing for best visibility.
- Use mast as required to increase vertical reach of handler.
- Use a signal man to assist in positioning the load if necessary.

Swing Forks

Capacity:

Maximum lift capacity for swing forks is shown on the attachment capacity chart. However, maximum lift capacity applies only to certain areas within boom extension/elevation pattern of handler/swing forks combination. A separate capacity chart must be used for handlers equipped with swing forks. Study and understand this chart before attempting to handle a load with swing forks attachment.



PRECAUTIONS

- Read additional capacity information under "Capacity" heading.
- Because the mast increases lift height, it is especially important to level the handler before lifting a load more than four feet (1.2m) above ground. (See Page 11.0)



Do not handle a load with Mast attachment until you study and understand the "Mast Capacity Chart." If your handler does not have a "Mast Capacity Chart," ask your supervisor to get one before using the attachment.



Do not handle a load with Swing Forks attachment until you study and understand the "Swing Forks Capacity Chart." If your handler does not have a "Swing Forks Capacity Chart," ask your supervisor to get one before using the attachment.

13.4

Attachment Tilt Controls:
Figure 13-4

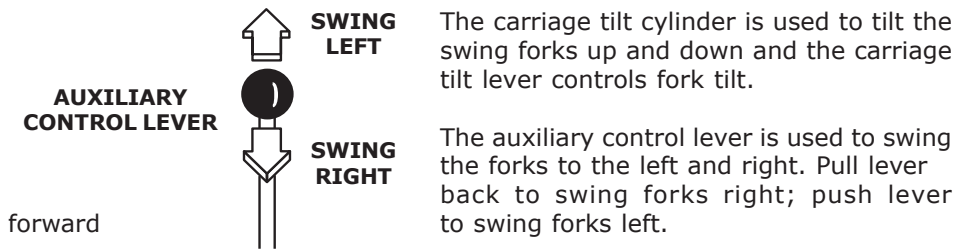

Installation Procedure:

1. Remove carriage/fork combination or other attachment from boom head. **(See Page 13.1)**
2. Install swing forks attachment on boom head.
3. Connect auxiliary hydraulic hoses to swing forks attachment.

Operation:

- Always position forks straight ahead before engaging load.
- To travel with load, keep forks in straight ahead position and lower load to 4 feet (1.2m) or less above ground allowing for best visibility.
- Inspect supporting surface at delivery point and have it leveled if necessary.
- Use a signal man to assist in positioning the load if necessary.

Slope Piler Carriage

Capacity:

Maximum lift capacity for the slope piler carriage is shown on the attachment serial number plate. However, maximum lift capacity applies only to certain areas within boom extension/elevation pattern of handler/slope piler carriage combination. A separate capacity chart must be used for handlers equipped with slope piler carriage. Study and understand this chart before attempting to handle a load with slope piler carriage.

Attachment Tilt Controls:
Figure 13-5

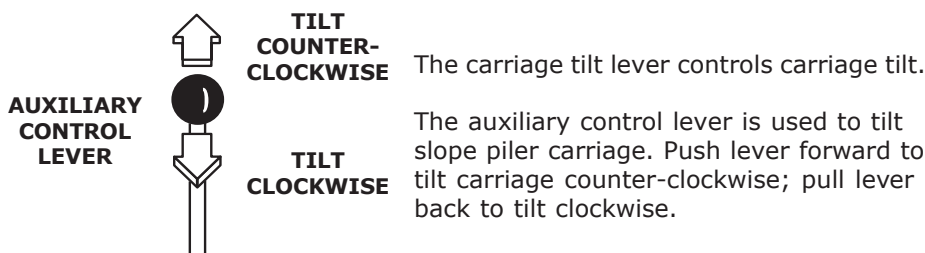

Installation Procedure:

1. Remove carriage/fork combination or other attachment from boom head. **(See Page 13.1)**
2. Install slope piler carriage on boom head.

Operation:

- Connect auxiliary hydraulic hoses to slope piler carriage attachment.
- Approach load with forks centered on load and stop handler.
- Level handler before tilting carriage to engage load.



PRECAUTIONS

- Read and understand additional capacity information under "Capacity" heading.
- Always level forks (horizontally) before swinging load to side. Swinging unlevelled forks may result in load slipping from forks.
- Because the swing forks can swing the load to the side, it is especially important that the handler be level when handling a load more than four feet (1.2m) above ground. **(See Page 11.0)**



PRECAUTIONS

- Level handler before tilting carriage to engage load.
- Always level handler before lifting a load more than four feet (1.2m) above ground. **(See Page 11.0)**



Do not handle a load with Slope Piler Carriage attachment until you study and understand the "Slope Piler Carriage Capacity Chart." If your handler does not have a "Slope Piler Carriage Capacity Chart," ask your supervisor to get one before using the attachment.

13.5

- Tilt carriage to left or right to align forks with load and engage load.
- Raise load slightly and then level carriage.
- Travel with load lowered to travel position 4 feet (1.2m) or less above ground.

Boom Head-Mounted Winch

Capacity:

The boom head-mounted winch maximum load capacity is shown on the standard carriage capacity chart. However, maximum capacity may be used only in areas where it does not exceed capacities shown on standard carriage/fork capacity chart (located on dashboard). Also note that maximum winch capacity is less than carriage/fork maximum capacity. Capacity rating is based on load being lifted and suspended vertically from the boom and with no load on forks.

Observe the following Special Precautions:

- Never drag the load; lift vertically.
- Use tag line to guide and steady a suspended load. Tag lines must be long enough to keep helpers clear of load and handler.
- Beware of wind. Wind can cause a suspended load to swing and cause dangerous side loads - even with tag lines.
- Start, travel, turn and stop slowly to prevent load from swinging.
- Weight of all rigging (slings, etc.) must be included as part of load.
- Do not attempt to use handler frame-leveling to compensate for load swing.

Attachment Tilt Controls:

Figure 13-6

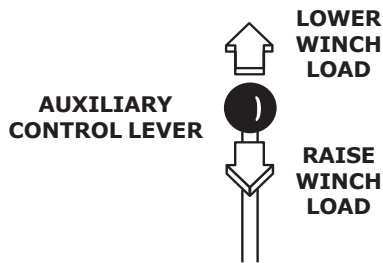

The auxiliary control lever is used to control the boom head-mounted winch. Pull the lever back to raise winch load; push the lever forward to lower winch load.

Installation Procedure:

1. Install winch on boom head and connect hydraulic hoses at winch motor.
2. Position winch hook directly above balance point of load and secure using appropriate rigging.

Operation:

- Attach tag lines to load and transport load to delivery site.
- While helpers guide load with tag lines, position load at delivery point.

WARNING

A side load or a swinging load could cause the handler to tip over and/or damage the boom.

WARNING

PRECAUTIONS

- Maximum winch load capacity is reduced from normal carriage/fork load rating.
- Always level handler before lifting a load.
(See Page 11.0)
- Travel with load and boom lowered to travel position load 4 feet (1.2m) or less above the ground.
- Always lower load to rest before leaving handler.

WARNING

Do not handle a load with Boom Head-Mounted Winch attachment until you study and understand the "Boom Head-Mounted Winch Capacity Chart" carefully. If your handler does not have a "Boom Head-Mounted Winch Capacity Chart," ask your supervisor to get one before using the attachment.

13.6

Truss Boom & Truss Boom with Winch

Capacity:

Maximum capacity for the truss boom (with or without winch) is shown on attachment serial number plate. However, maximum lift capacity applies only to certain areas within boom extension/elevation pattern of handler/truss boom combination. A separate capacity chart must be used for handlers equipped with truss boom. Study and understand this chart before attempting to handle a load with truss boom.

Observe the following Special Precautions:

- Never drag the load; lift vertically.
- Use tag line to guide and steady a suspended load. Tag lines must be long enough to keep helpers clear of load and handler.
- Beware of wind. Wind can cause a suspended load to swing and cause dangerous side loads - even with tag lines.
- Start, travel, turn, and stop slowly to prevent load from swinging.
- Weight of all rigging (slings, etc.) must be included as part of load.
- Do not attempt to use handler frame-leveling to compensate for load swing.

Attachment Tilt Controls:

Figure 13-7

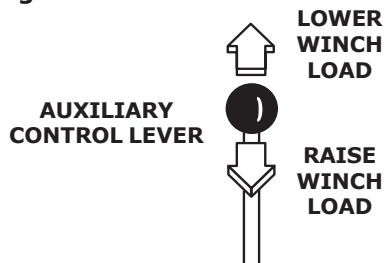

The carriage tilt cylinder is used to tilt the truss boom up and down from the handler boom head. The carriage tilt lever controls truss boom tilt.

The auxiliary control lever is used when the truss boom is furnished with a winch. Pull the lever back to raise winch load; push the lever forward to lower winch load.

Installation Procedure:

1. Remove carriage/fork combination or other attachment from boom head. **(See Page 13.1)**
2. Install truss boom on boom head.

Operation:

- If truss boom winch is furnished, connect auxiliary hydraulic hoses to winch.
- Approach truss or truss bundle with boom above and parallel to load.
- Position truss boom approximately parallel with main boom.
- Position truss boom/winch hook as close as possible to balance point of load and secure load to boom using short slings or other rigging. Be sure rigging will not allow load to slip in any direction.



PRECAUTIONS

- Because the truss boom extends the reach of the handler, maximum load capacity is reduced.
- Because of extended reach, it is especially important to level the handler before lifting a load. **(See Page 11.0)**
- Travel with load and boom lowered to travel position 4 feet (1.2m) or less above ground.
- Always lower load to rest before leaving handler.



Do not handle a load with Truss Boom & Truss Boom with Winch attachment until you study and understand the "Truss Boom & Truss Boom with Winch Capacity Chart." If your handler does not have a "Truss Boom & Truss Boom with Winch Capacity Chart," ask your supervisor to get one before using the attachment.



A side load or a swinging load could cause the handler to tip over and/or damage the boom.

13.7

- Open clamps at heel of truss boom far enough to clear load and tilt truss boom up until truss/bundle contacts heel of truss boom.
- Close clamps to hold load lightly and secure clamps.
- Transport load to delivery site and attach tag lines if load will be freely suspended.

Swing Mast

Capacity:

Maximum lift capacity is shown on attachment serial number plate. However, maximum lift capacity applies only to certain areas within boom extension/elevation pattern of handler/swing mast combination. A separate capacity chart must be used for handlers equipped with mast. Study and understand this chart before attempting to handle a load with swing mast attachment.

Controls:

Figure 13-8

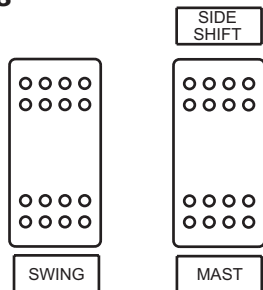

The carriage tilt cylinder is used to tilt the mast and the carriage. Tilt lever controls mast tilt.

- Press right switch up to "SIDE SHIFT" to activate side shift function. Move auxiliary hydraulic lever in appropriate direction.
- Press left switch down to "SWING" to activate swing function. Move auxiliary lever in appropriate direction.
- Press right switch down to "MAST" to activate mast function. Move auxiliary lever in appropriate direction.

Installation Procedure:

1. Remove carriage/fork combination or other attachment from boom head. (See Page 13.1)
2. Install swing mast on boom head and connect auxiliary hydraulic hoses to swing mast diversion valve hoses. Also connect electrical cable at boom head.

Operation:

- Always lower carriage fully in mast and position forks straight ahead before engaging load.
- To travel with a load, keep forks straight ahead and lower load to travel position 4 feet (1.2m) or less above ground.
- Inspect supporting surface at delivery point and have it leveled if necessary.
- Level handler before raising load.
- If necessary, perform a "dry-run" (unloaded) of delivery to determine best position for handler.
- Use a signal person to assist in positioning the load if necessary.

WARNING

PRECAUTIONS

- Always level forks (horizontally) before swinging load to side. Swinging unlevelled forks may result in load slipping from forks.
- The swing mast attachment has a smaller load capacity than the standard carriage/fork attach. Study and understand the swing mast capacity chart before handling a load with swing mast.
- Read additional capacity information under "Capacity" heading on chart.
- Because the swing mast increases lift height and can swing load to side; it is especially important to level handler before lifting a load more than four feet (1.2m) above ground level. (See Page 11.0)

WARNING

Do not handle a load with Swing Mast attachment until you study and understand the "Swing Mast Capacity Chart." If your handler does not have a "Swing Mast Capacity Chart," ask your supervisor to get one before using the attachment.

WARNING

Observe all precautions and load capacity limits when handling loads.

13.8

Personnel Work Platform

The material handler operator and personnel in the platform must read and understand the separate personnel work platform manual, included with the attachment, prior to using the platform.

Capacity:

The Gradall personnel work platform is designed to carry a maximum of 3 occupants. The load includes personnel, materials, tools, etc. The maximum capacity of your work platform is based on specific model material handler/work platform combination. To determine maximum load capacity for given operating ranges, consult the proper load capacity chart (furnished with platform) for the material handler and work platform in use. **If your handler is not equipped with the proper personnel work platform capacity chart, get one before using the attachment.**

Installation Procedure:

1. Remove carriage/fork combination or other attachment from boom head.
(See Page 13.1)

Operation:

- Gradall Personnel Work Platforms are approved for use **only** on Gradall Material Handlers equipped with the proper platform capacity chart.
- When lifting personnel, **use only a Gradall manufactured personnel work platform**. No other platform is approved for use on Gradall Material Handlers.



Do not use the Personnel Work Platform until you study & understand the "Capacity Chart". If your handler does not have the correct "Personnel Work Platform Capacity Chart", ask your supervisor to get one before using the attachment.



Do not use a boom mounted winch while the platform is mounted to the boom.

14.0 OBTAINING HYDRAULIC OIL SAMPLE

1. Operate unit until hydraulic oil reaches normal operating temperature.
2. Apply parking brake, lower boom to ground and shift Forward/Reverse lever to "Neutral." Observe Hydraulic Filter Bypass Indicator with engine running at full throttle. Replace filter elements if necessary.
3. Obtain a container to receive waste oil and a **CLEAN** container to receive oil sample.
4. With gauge removed from hose, attach mini-check and hose to test port near right wall of engine compartment. Hose end must be positioned in waste oil container.
5. Allow at least one pint of oil to flow into waste oil container to eliminate any contamination from hose.
6. Move hose to **CLEAN** container to collect sample for analysis.
7. Return hose to waste oil container and disconnect adapter from mini-check test port.
8. Cover sample container immediately with **CLEAN** cap.
9. Stop engine and check oil level in reservoir and replenish as required.
10. Contact your GRADALL Distributor for information concerning oil analysis.

Oil sample containers are available from several sources:

- Oil companies
- Oil suppliers
- Sampling labs



TAKE HYDRAULIC SAMPLE
FROM THIS PORT

NOTE!

*OIL CLEANLINESS IS CRITICAL
The filtration system is designed
to maintain a minimum ISO
cleanliness level of 18/15.*

15.0 LOADING & SECURING FOR TRANSPORT

Loading & Securing Handler For Transport

1. Level the material handler prior to loading.
2. Using a spotter, load the handler with boom as low as possible to keep a low center of gravity.
3. Once loaded, apply parking brake and lower boom until boom or attachment is resting on deck. Move all controls to "Neutral," stop engine and remove ignition key.
4. Secure machine to deck by passing chains through two tie-down lugs on front and rear of machine. **(See Figures 15-1 & 15-2)**
5. Do not lower stabilizers or tie down front of boom.

Figure 15-1



Figure 15-2



WARNING

Before loading handler for transport, make sure deck, ramps and handler wheels are free of mud, snow and ice. Failure to do so could cause handler to slide, resulting in an accident causing serious injury or death.

NOTE!

Machine depicted may not be model covered by this manual, however, tie-down locations are similar.

16.0 MOVING HANDLER IN EMERGENCY

The following information assumes the handler cannot be moved under its own power.

Before moving the handler, read all of the following information to understand options available. Then select the appropriate method.

The ability to steer the handler increases the safety of moving the unit in some situations. The steering system permits manual steering if engine or power assist feature fails.

Remember:

- Although manual steering is possible without power assist, **steering will be slow and will require much greater force.**

MOVING SHORT DISTANCES

If it is only necessary to move handler a short distance, less than 100 feet (30m), it is permissible to use a vehicle of sufficient capacity to tow the unit with no previous preparation. Drive wheels will not roll. If the unit must be moved more than 100 feet (30m), but less than 200 yards (182m), it is permissible to use a vehicle of sufficient capacity to tow unit after you:

- Activate "Tow Bypass." (*See Below*)
- Release parking brake. (*See Page 16.1*)

MOVING LONGER DISTANCES

If the handler must be moved more than 200 yards (182m), it must be loaded on to a trailer of sufficient capacity.

TO ACTIVATE TOW BYPASS

Figure 16-1

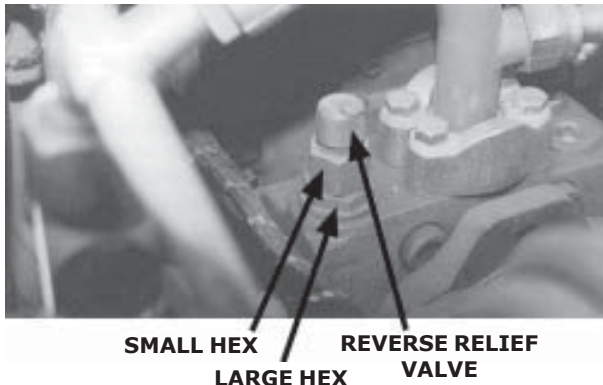

1. Shut down machine and block wheels.
2. Mark position of relief valve cartridge (small hex).
3. Hold large hex to prevent movement and loosen reverse relief valve cartridge (small hex) two full turns.
4. Repeat steps 2 and 3 for forward relief valve. Front axle drive is now bypassed.
5. Disengage rear drive hubs (Fairfield hubs do not disengage).
6. Before returning machine to service, be certain to **return relief valve cartridges to original position and re-engage rear drive hubs.**

WARNING

Towing handler with all wheels on ground for more than 200 yards (182m) could cause serious damage to hydraulic drive components.

CAUTION

Do not operate hydrostatic drive system with rear hubs disengaged as the hydraulic rear-drive motors may be severely damaged.

NOTE!

Forward relief valve is located on bottom of pump case directly below reverse relief valve.

16.1

TO RELEASE PARKING BRAKE MERITOR AXLE

1. Position unit on level ground, lower attachment to approximately one foot (.3m) from ground, move forward/reverse lever to "Neutral," apply parking brake and stop engine.
2. Block all wheels to prevent inadvertent movement.

Figure 16-2

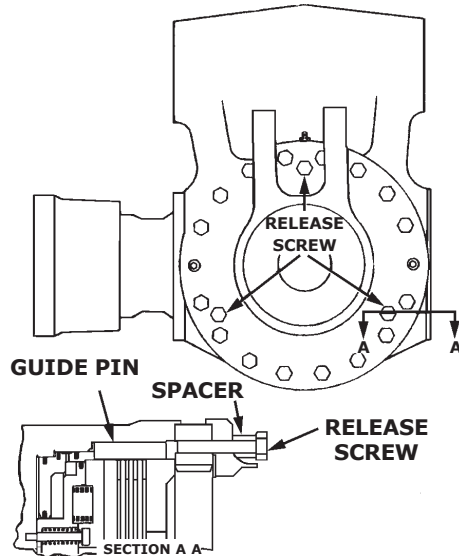

3. Working one side at a time, remove three release screws and spacers from side of differential housing (located at 12 o'clock, 4 o'clock and 8 o'clock).
4. Put spacers aside and install release screws. Tighten each screw lightly until it just makes contact with guide pin.
5. Working carefully, tighten each release screw only 1/4 turn (90°) at a time, in sequence, until all three screws have been turned one full turn 360°, approximately 50 ft.-lb. (67n.m). Larger turns could cause components to bind and cause brake failure.
6. Repeat this procedure on other side of differential. Parking brake should be released.

TO RESTORE PARKING BRAKE

1. Make certain engine is stopped and all wheels are blocked.
2. Loosen each release screw, only 1/4 turn at a time, in sequence, until each screw has lost contact with guide pin. Then remove release screws.
3. Install previously removed spacer over bolt and install release screws and tighten.
4. Repeat procedure on other side of differential. Parking brake should be restored to operation.

16.2

CARRARO AXLE

1. If possible position unit on level ground lower attachment to approximately one foot from ground, move forward/reverse lever to "Neutral", apply parking brake and stop engine.
2. Block all wheels to prevent inadvertent movement.

Figure 16-3

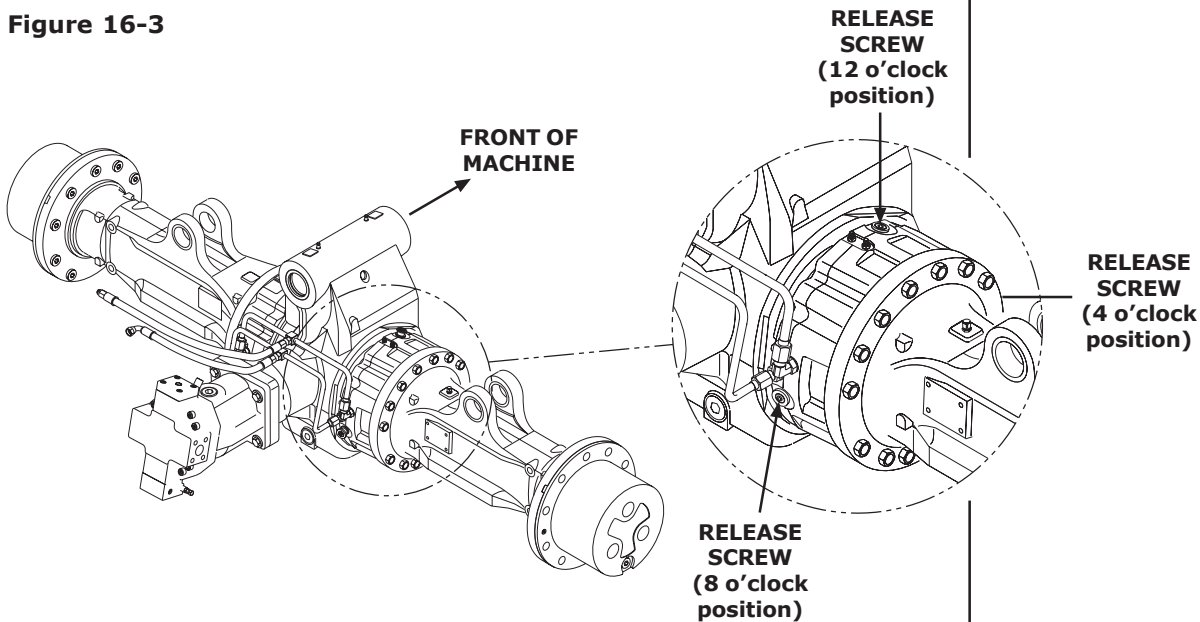

3. Working one side at a time, remove three plugs from differential housing (located at 12 o'clock, 4 o'clock and 8 o'clock). Put plugs aside.
4. Tighten each release screw revealed by the plugs, lightly until some resistance is felt.
5. Working carefully, tighten each release screw only 1/2 turn (180°) at a time, in sequence, until all three screws have been turned approximately five full turns. Larger turns could cause components to bind and cause brake failure.
6. Repeat this procedure on other side of differential. Parking brake should be released.

TO RESTORE PARKING BRAKE

1. Make certain engine is stopped and all wheels are blocked.
2. Loosen each release screw, only 1/2 turn at a time, in sequence, until each screw has lost contact with guide pin. Back out each screw until it bottoms out against the stop. Then screw the bolts back in 1/4 turn.
3. Install plugs over each release screw.
4. Repeat procedure on other side of differential. Parking brake should be restored to operation.

THIS PAGE INTENTIONALLY LEFT BLANK.

17.0 MAINTENANCE

NOMENCLATURE

Figure 17-1

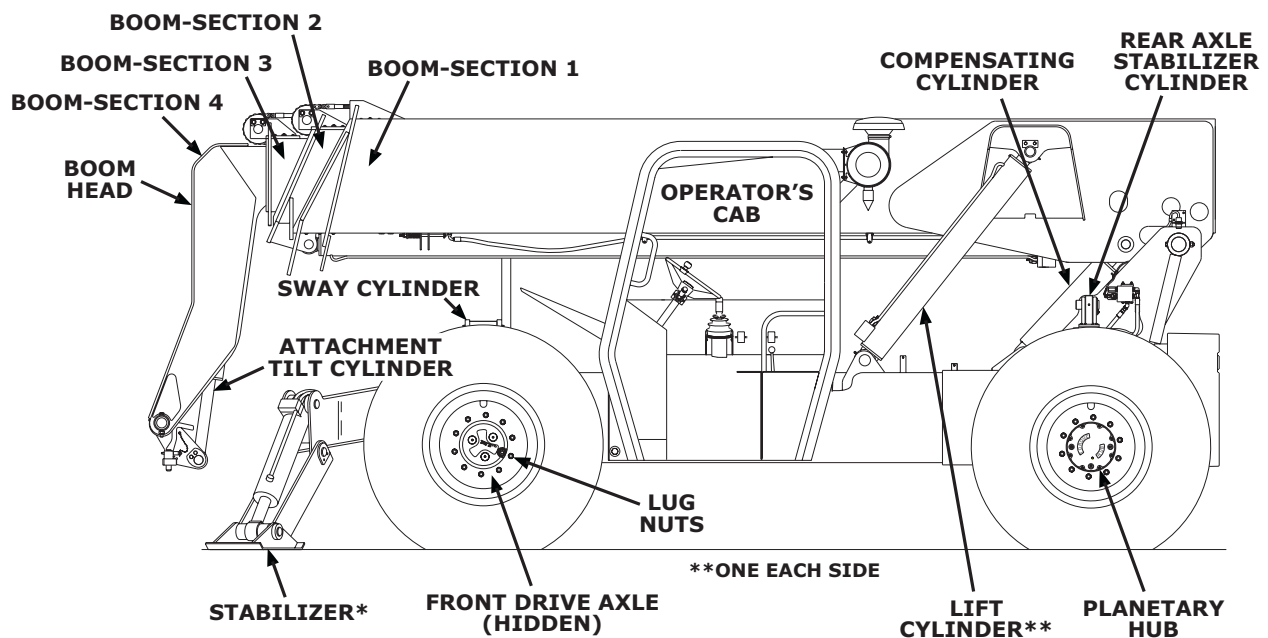
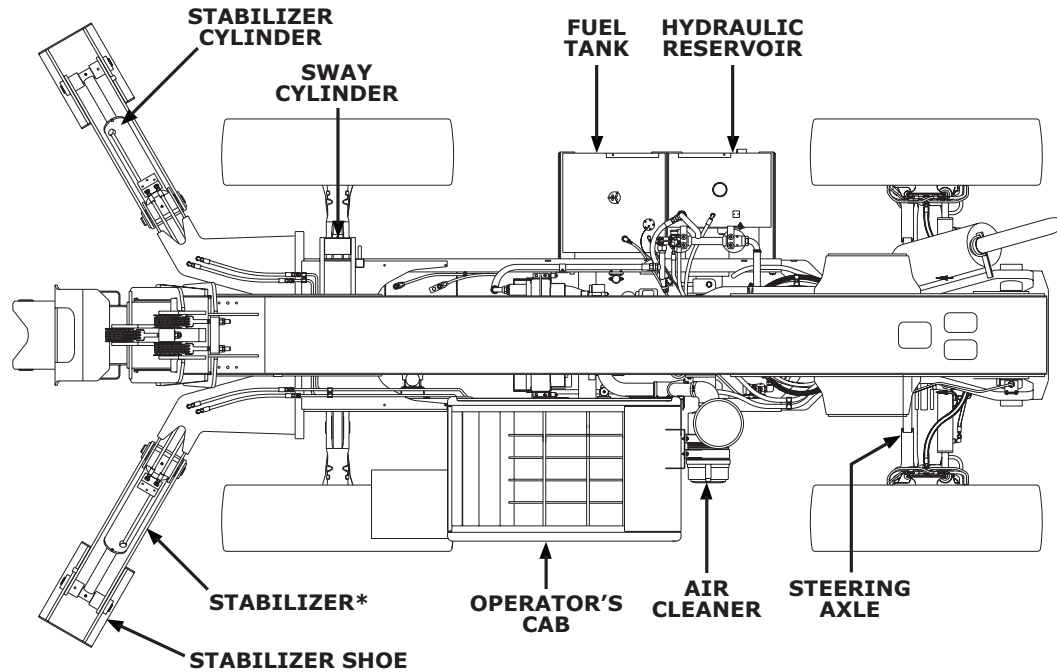

*NOTE!

GRADALL typically uses the term "Outrigger" because of its common use in the construction industry and by S.A.E. Now, some manufacturers and ASME use the term "Stabilizer". Within this manual, these terms are interchangeable.

17.1 LUBRICATION & ROUTINE MAINTENANCE

Figure 17-2

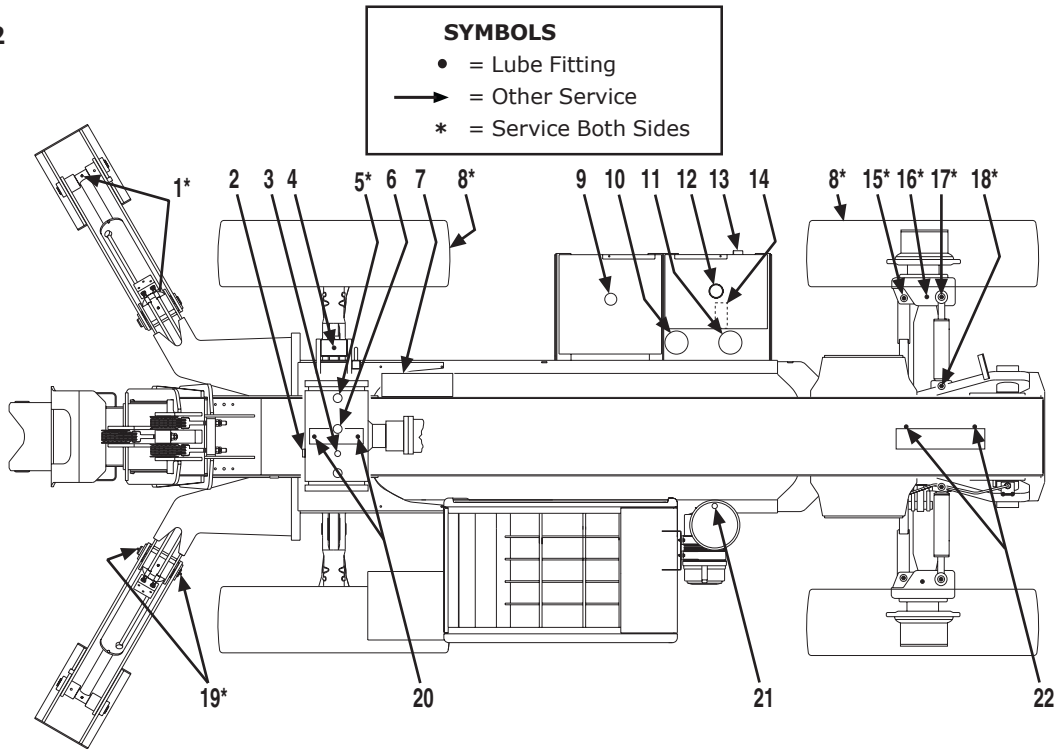

Lubrication Symbols	
AF	- ANTI-FREEZE (permanent)
CC	- COOLANT CONDITIONER
CL	- CHAIN LUBE
DF	- DIESEL FUEL
EO	- ENGINE FUEL
HF	- HYDRAULIC FLUID
HM	- MOLY LUBE (extreme pressure)

**FAILURE TO USE GRADALL
HYDRAULIC FILTER ELEMENTS
COULD VOID WARRANTY**

IMPORTANT NOTICE
Be certain to check extend chain adjustment every 5 weeks or 250 hours and adjust as required. Chain damage can occur if chain is not adjusted properly.

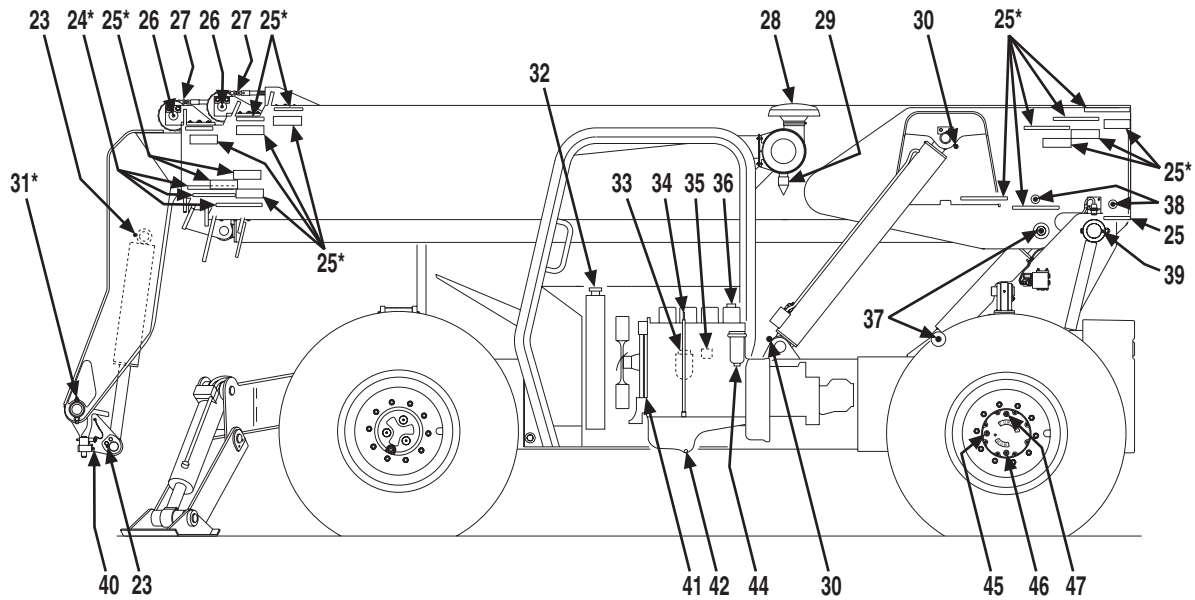

LUBRICATION NOTICE

- Apply a light coating of engine oil to all linkage pivot points.
- Clean lubrication fittings before lubricating.
- Intervals shown are for normal (8-hour day) usage and conditions. Adjust intervals for abnormal usage and conditions.
- Drain engine and gear cases after operating when oil is hot.
- Check lubricant levels when lubricant is cool.
- Clean filter and air cleaner housing and reusable elements using solvent or diesel fuel. Dry components thoroughly using lint free cloth.



Service intervals are based on machine usage of 1500 hours annually. Use of your unit may vary significantly and you must adjust service frequency for your usage to obtain maximum service life. Frequency headings in the following schedule indicate a calendar limit and an operating hour limit. Perform service at whichever interval occurs first.

	Lube Symbol	No. of Points
Daily or Shift (10 hour Maximum) Lubrication & Maintenance		
9. Fuel Filler Cap (fill at end of work shift to minimize condensation)	DF	1
10. Hydraulic Return Filter Condition Indicator (check with oil at normal operating temperature and engine running at full throttle - replace element before by-pass indication is reached or at least annually)	-	1
11. Hydraulic Suction Filter (replace filter element when return filter element is replaced)	-	1
13. Hydraulic Level Sight Gauges (level handler, retract all other cylinders and check sight gauges - refill as required)	HF	1
21. Air Cleaner Element Condition Indicator (check for clogged condition (red band showing) and clean or replace element as required - item 28 is air cleaner) Note: If equipped with safety (small) element, change it every 3rd change of primary (large) element.	-	1
34. Engine Crankcase Dipstick (level handler and check level - refill as required - item 36 is filler cap)	EO	1

	Lube Symbol	No. of Points
Weekly (or 50 Hour) Lubrication & Maintenance (include all previous periodic services)		
1. Stabilizer Cylinder Pivots	HM	4
4. Sway Cylinder Pivots	HM	2
7. Battery (check terminals)	-	1
8. Tires: Standard: 14.00 x 24, 12 ply - 65 PSI (448 kpa) Optional: 14.00 x 24, Radial - 70 PSI (482 kpa)	-	4
15. Tie Rod Ends	HM	2
16. King Pins	HM	4
17. Steering Cylinder Rod Pivots	HM	2
18. Steering Cylinder Barrel Pivots	HM	2
19. Stabilizer Arm Pivots	HM	4
20. Front Axle Pivot	HM	2
22. Rear Axle Pivot	HM	2
23. Carriage Tilt Cylinder Pivots	HM	2
24. Boom Bottom Front Slide Bearings (extend boom fully and lube all wear paths - retract and extend boom fully three times and wipe excess lube from bearings)	HM	6
26. Extend Chain Sheave Pin	HM	3
30. Boom Lift Cylinder Pivots	HM	4
31. Boom Head/Carriage Pivot	HM	2
32. Radiator Fill Cap (check level and refill as required)	AF	1
37. Compensating Cylinder Pivots	HM	2
38. Retract Chain Sheave Pivots	HM	2
39. Boom Pivot	HM	2
40. QuickSwitch Latch	HM	1
44. Fuel Filter/Water Separator with Drain (drain water)	-	1

	Lube Symbol	No. of Points
At End of First 50 Hours Only		
5./6. Planetary and Differential Drain Plugs (drain and refill - wait 5 minutes and fill again - item 2 is level plug)	HF	3

	Lube Symbol	No. of Points
At End of First 30 Days Only (250 Hours Maximum) Lubrication & Maintenance		
• Check torque of all items listed in Torque Chart (pg 17.2)		

	Lube Symbol	No. of Points
5 Week (or 250 Hour) Lubrication & Maintenance (include all previous periodic services)		
2. Drive Axle Level Plug (check level and refill as required)	HF	1
12. Hydraulic Reservoir Breather Cap (check and clean or replace cap as required)	-	1
24. Boom Bottom Front Slide Bearings, to be performed by experienced maintenance person - check for damage and excessive wear - no wear permitted past bevel - maximum clearance at top bearing is 1/8 inch (3mm), shim or replace as required; when these bearings require service, check all other slide bearings - shims are 1/16 inch (1.5mm) thick	HM	6
25. Boom Top, Side and Bottom Rear Slide Bearings (extend boom fully and lube all wear paths - retract and extend boom fully three times and wipe excess lube from bearings)	HM	36
29. Vacuator Valve (rubber cone on bottom - check to be sure cone is clear and undamaged)	-	1
33. Engine Oil Filter (replace filter element)	-	1
41. Drive belts (check condition - replace as required)	-	1
42. Engine Crankcase Drain Plug (drain and refill to level)	EO	1
45. Rear Hub Level Plug (check level and refill as required)	HF	2
• Check torque of all items listed in Torque Chart (pg 17.2)		

	Lube Symbol	No. of Points
Quarterly (or 500 Hour) Lubrication & Maintenance (include all previous periodic services)		
12. Hydraulic System (we recommend that hyd fluid be analyzed to determine condition - drain and refill reservoir if required)	HF	1
14. Hydraulic Reservoir Screen (remove, clean and install when hydraulic oil is drained)	-	1
27. Boom Extend Chains (check for proper switch adjustment & adjust or replace as required)	-	3
35. Fuel Strainer (replace)	-	1
44. Fuel Filter/Water Separator with Drain (replace filter element)	-	1

	Lube Symbol	No. of Points
Semi-Annual (or 1000 Hour) Lubrication & Maintenance (include all previous periodic services)		
3. Front Axle Breather (clean or replace)	-	1
5./6. Planetary and Differential Drain Plugs (drain, fill to level, wait 5 minutes and fill to level again - item 2 is level plug)	HF	1
12. Hydraulic Reservoir Breather Cap (clean or replace)	-	1
27. Boom Extend Chains (ext boom & lube chains)	CL	3
46. Rear Hub Drain Plug (drain and refill - item 47 is fill plug)	HF	2

	Lube Symbol	No. of Points
Annual (or 1500 Hour) Lubrication & Maintenance (include all previous periodic services)		
10. Hydraulic Return Filter (replace filter element)	-	1
11. Hydraulic Suction Filter (replace filter element)	-	1
12. Hydraulic System (unless fluid is analyzed quarterly to determine degree of contamination, reservoir must be drained and refilled on an annual basis)	HF	1
14. Hydraulic Reservoir Screen (remove, clean and install when hydraulic oil is drained)	-	1
32. Engine Cooling System (drain, flush and refill on basis of period suggested by anti-freeze manufacturer and add Liquid Coolant Additive if equipped with Deere engine)	AF/CC	1

DETAILED SERVICE INSTRUCTIONS ARE CONTAINED IN THE GRADALL SERVICE MANUAL FOR YOUR PARTICULAR MATERIAL HANDLER

17.2 RECOMMENDED LUBRICANTS & CAPACITIES

APPLICATION	SYMBOL	WHEN USED	GRADE	SPECIFICATION	CAPACITY*	
Boom Chain Adj. Threads	HM (extreme pres. moly lube)	All Year	-	1440-3323	-	-
Boom Slide Bearing Paths	HM (extreme pres. moly lube)	All Year	NLGI #2	1440-4595	-	-
Boom Extend Chains	CL (chain lube)	All Year	-	1440-4751		
Coolant Conditioner (Deere Only)	CC (supplemental coolant additive)	All Year	-	-	0.5 qts	0.48 L
Engine Cooling System Cummins Deere	AF (anti-freeze) AF (anti-freeze)	All Year All Year	½ & ½ ½ & ½	Permanent Permanent	24 qts 24.8 qts	22.7 L 23.5 L
Engine Crankcase Cummins Deere	EO (engine oil) EO (engine oil)	All Year All Year	15W-40-CD 15W-40-CD	MIL-L-2104D MIL-L-2104D	12 qts 14.5 qts	11.4 L 13.5 L
Front Axle Meritor Carraro	HF (hydraulic fluid) HF (hydraulic fluid)	All Year All Year	** **	** **	5.28 gal 4.91 gal	20 L 18.6 L
Fuel Tank	DF (diesel fuel)	All Year	#2	-	40 gal	151.6 L
Grease Fittings	HM (extreme pres. moly lube)	All Year	NLGI #2	1440-4595	-	-
Hydraulic System	HF (hydraulic fluid)	All Year	***	***	50 gal	189.3 L
Rear Hubs	HF (hydraulic fluid)	All Year	**	**	3 pints ea	1.4 L

* Capacities are approximate - check level to be sure.

** Fill to level using **Mobilfluid® 424** (GRADALL P/N 1440-4535)

*** Fill to level using **Mobilfluid® 424** -OR- *Citgo Tractor Hydraulic Fluid* (product code 33310)

TORQUE CHART

Check torque using accurate torque wrench to apply maximum torque value shown. DO NOT EXCEED MAXIMUM TORQUE. Excess maximum torque may cause fastener to fail.

ITEM	FREQUENCY*	THREAD SIZE (GRADE)	TORQUE (lubricated)			
			FT.-LB.		Nm	
			MINIMUM	MAXIMUM	MINIMUM	MAXIMUM
Boom Slide Bearings (front)	5 Weeks (250 hrs)	3/8-24 (5)	32	37	43	50
	5 Weeks (250 hrs)	1/2-20 (5)	68	78	92	106
Boom Slide Bearings (rear)	If front bearings have worked loose	3/8-24 (5) 1/2-20	32 68	37 78	43 92	50 106
Boom Extend Chains (rear) Adjusting Nut Jam Nut	5 Weeks (250 hrs)	1-8 (-)	†	†	†	†
	5 Weeks (250 hrs)	1-8 (-)	175	215	238	292
Wheel Lug Nuts	3 Months (500 hrs)	-	350	400	476	544
Cab MTG Bolts		7/8-9	450	475	612	646

* Check torque at whichever interval occurs first.

† Refer to appropriate **Service Manual** for procedure to check and adjust cables.

17.3 BOOM

CHECKING & ADJUSTING BOOM CHAINS

Boom is extended by a cylinder and a set of chains within the boom.

For more detailed information, including boom chain checks and adjustments, see the appropriate **Service Manual**.

STABILIZER

Stabilizers are furnished as standard equipment on all 544D-10 Material Handlers.

Use stabilizers to increase stability and/or load capacity and in leveling the handler before picking or delivering a load. Study load charts carefully to determine maximum load capacities for various lift situations, with and without stabilizers.

Before using stabilizers to support handler/load on untested surface, perform following procedure:

1. With handler positioned to pick or deliver load and with load on ground or pick point, lower stabilizers enough to level handler and remove weight from front wheels.
2. If required, position signal man to observe and report penetration of stabilizer shoes in supporting surface.
3. With forks beneath load, slowly begin to raise load. Stop immediately if signal man reports excessive or uneven shoe penetration. If shoe penetration is acceptable, proceed with lift. If stopped by signal man, relieve load from forks and proceed with steps 4 and 5.
4. With forks resting on ground, raise stabilizers from surface far enough to install sufficient blocking to overcome excessive or uneven shoe penetration.
5. Repeat steps 3 and 4 until excessive or uneven penetration has been overcome before lifting load.

Transport machine with stabilizers in the “up” position as shown in Figure 17-3.



Stabilizers increase stability and load capacity ONLY if they are used properly. Using stabilizers without regard to surface conditions could cause handler to tip over and result in serious injury or death. Always ensure surface can support handler and load.

Figure 17-3







HAND SIGNALS

Standard Signals - When handler work conditions require hand signals, they shall be provided or posted conspicuously for the use of both signalman and operator. No handler motions shall be made unless signals are clearly understood by both signalman and operator.

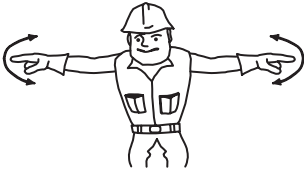
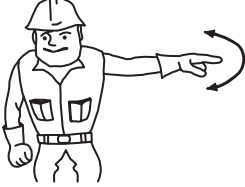
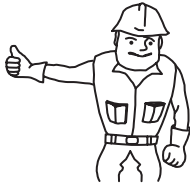
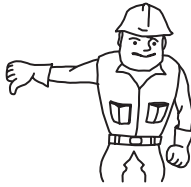
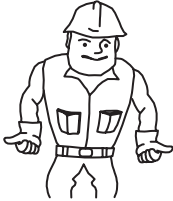
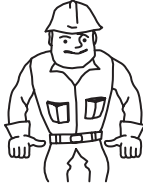
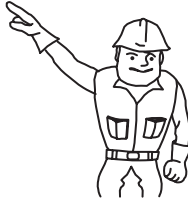
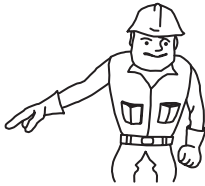
Special Signals - When signals for auxiliary equipment functions or conditions not covered are required, they shall be agreed upon in advance by the operator and signalman.

Instructions - When it is desired to give instructions to the operator other than provided by the established signal

 <p>EMERGENCY STOP - With both arms extended laterally, hands open downward, move arms back and forth.</p>	 <p>STOP - With either arm extended laterally, hand open downward, move arm back and forth.</p>	 <p>RAISE BOOM - With either arm extended horizontally, fingers closed, point thumb upward.</p>	 <p>LOWER BOOM - With either arm extended horizontally, fingers closed, point thumb downward.</p>
 <p>EXTEND TELESCOPIC BOOM - With both hands clenched, point thumbs outward.</p>	 <p>RETRACT TELESCOPIC BOOM - With both hands clenched, point thumbs inward.</p>	 <p>TILT FORKS UP - With one arm held at side, extend other arm upward at about 45°.</p>	 <p>TILT FORKS DOWN - With one arm held at side, extend other arm downward at about 45°.</p>
 <p>CLOSE BUCKET - Hold one hand closed and stationary. Rotate other hand in small vertical circle with forefinger pointing horizontally at closed hand.</p>	 <p>OPEN BUCKET - Hold one hand open and stationary. Rotate other hand in small vertical circle with forefinger pointing horizontally at open hand.</p>	 <p>MOVE SLOWLY - Place one hand motionless in front of hand giving motion signal. (Raise load slowly is shown)</p>	 <p>THIS FAR TO GO - With hands raised and open inward, move hands laterally, indicating distance to go.</p>

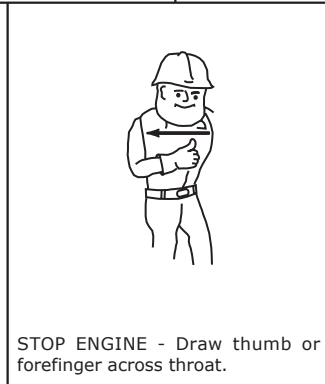

CALIFORNIA

Proposition 65 Warning

Diesel engine exhaust and some of its constituents are known to the State of California to cause cancer, birth defects and other reproductive harm.

CALIFORNIA

Proposition 65 Warning

Battery posts, terminals and related accessories contain lead and lead compounds, chemicals known to the State of California to cause cancer and birth defects or other reproductive harm.
Wash hands after handling.

GRADALL[®]

406 Mill Ave. SW, New Philadelphia, Ohio USA 44663
Phone (330) 339-2211 Fax (330) 339-8468
<http://www.gradall.com>