

Manitex
INDUSTRIAL CRANES



CD90i

**9-ton (8,2 mt) CARRY DECK CRANE
PRODUCT GUIDE**

CONTENTS

Crane Features 4

Boom Diagram 5

Crane Weight 5

Load Chart: Main Boom & Jib 6

Area of Operation 7

Crane Dimensions 8

Technical Descriptions 9-10

Options 11

Effective Date: February 10, 2014

This document is non-contractual. This document is supplied for reference use only. We are constantly making improvements to our products and reserve the right that specification, equipment, and prices are all subject to change without notice or obligation.

The photographs, and /or images in this document are for illustrative purposes only and may include optional equipment and accessories and may not include all standard equipment.

Refer to the appropriate Operator’s Manual and Load Charts for instructions on the proper use of this equipment to determine allowable crane lifting capacities, assembly and operating procedures.

Failure to follow the appropriate operator’s manual or load chart(s) when using our equipment or to otherwise act irresponsibly may result in serious injury or death.

The only warranty applicable to our equipment is the standard written warranty applicable to the particular product and sale. Manitex makes no other warranty, expressed or implied.





















Products and services listed may be trademarks, service marks or trade-names of Manitex International and /or its subsidiaries in the USA and other countries.





















All rights are reserved. Manitex® is a registered trademark of Manitex International, Inc. in the USA and many other countries.

Copyright 2014 Manitex Inc. Manitex Inc, Georgetown Texas, 78626



KEY

	Engine
	Steering
	Gross vehicle weight
	Weight on rear axle
	Standard (without hook block)
	Operator aids
	Operator's station
	Heating / Air conditioning
	Controls
	Hoist speed
	1 - Main hoist 2 - Auxiliary winch 3 - Recovery winch
	Rope length
	Rope - standard/optional
	Rope diameter
	Maximum line pull
	Slewing / Allowable slewing range
	Slewing gears
	Slewing brake
	Outriggers / Lifting on outriggers
	Frame

	Mechanical transmission
	Tires
	Hydraulics
	Weight on front axle
	Lifting on wheels / Pick & Carry
	Maximum gradeability
	Hook block
	Hook and ball
	Boom elevation angle
	Max. boom length with extension
	Boom with extension retracted
	Telescoping mode
	Working radius
	Boom length
	Hydraulic actuated boom
	Full power mechanical synchronized
	Tip height
	Lights
	Electrical system
	Maximum speed



THE CD90i CARRY DECK CRANE

Tight space? No problem!

The Manitex CD90i is our new industrial crane designed to lift loads that can't easily be reached by a traditional crane or forklift. The 9-ton, cab-down crane maneuvers smoothly through cramped machine shops or shipyards and, with its unique outrigger system, can be positioned close to the load. It offers:

- Multiple steering modes (2 Wheel, Crab, Coordinated)
- Powershift transmission with 4 forward - 3 reverse speeds
- Maximum travel speed of 17.9 mph (28.8 kph)

Other features include:

- Rated capacity: 9-ton (8,2 mt) at 5 ft. (1,5 m) working radius
- Max. boom length: 25.4 ft. (7,7 m)
- Max. tip height: 33 ft. (10,1 m)
- Load Indicator System

CAB/CONTROLS

Minimize risk. Direct acting hydraulic controls are standard so there's no risk of high-pressure hose leaks in the cab.



OUTRIGGERS

Lift confidently. Out-and-down outriggers extend adding stability, letting you inch closer to the load.



OPERATOR AIDS

Work smarter. Greer's Insight LMI system allows the operator quick access to critical data in high-resolution VGA graphics.



BOOM DIAGRAM

Imperial & Metric Units

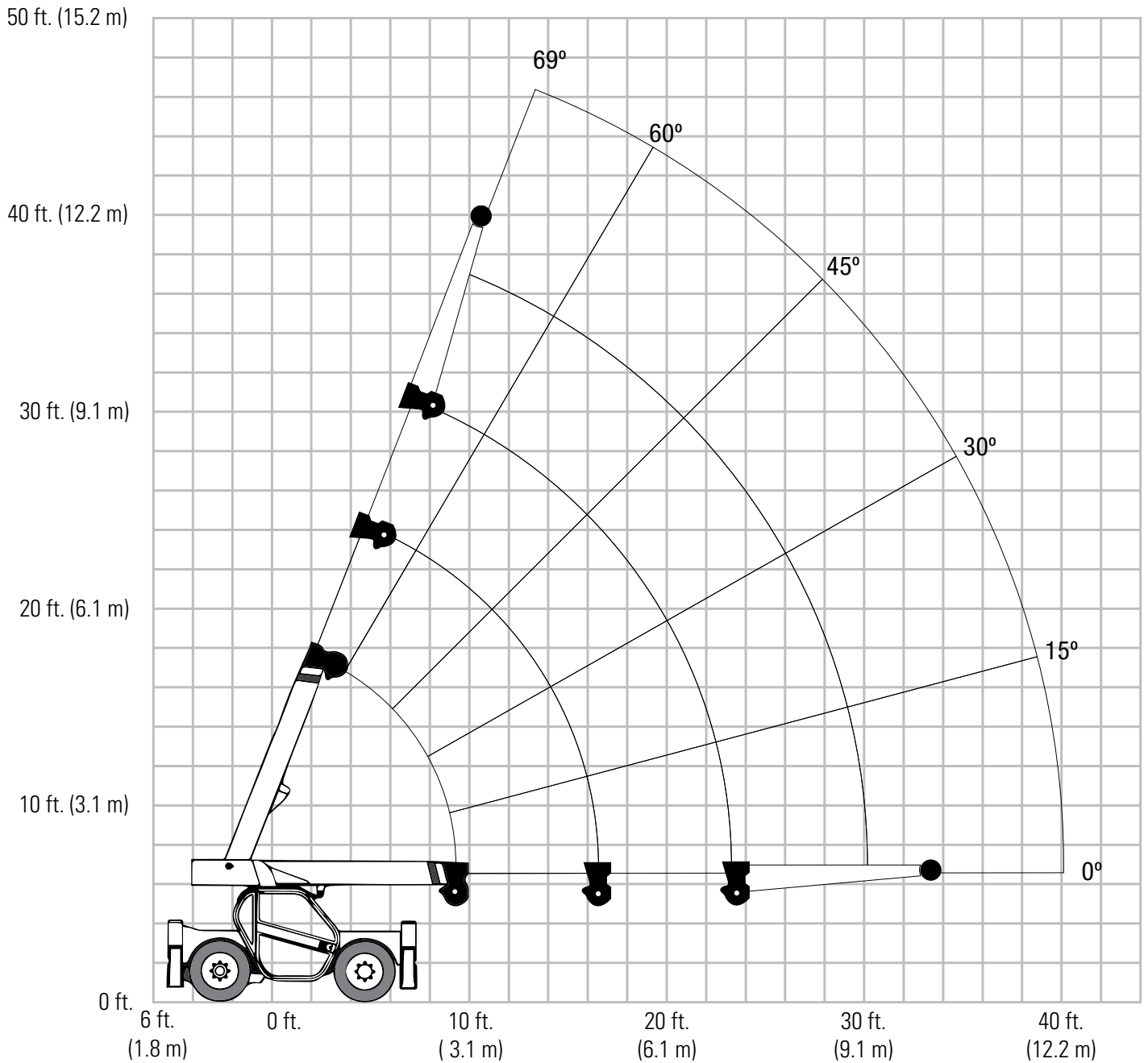

CRANE WEIGHT

Standard (without hook block):

16,535 lbs. (7,500 kg)

Data published herein is intended as a guide only. Crane operation is subject to the computer charts and operation manual supplied with the crane.

LOAD CHART: Main Boom & Jib

Lifting Capacities 3 Section Boom 11.6 ft. - 25.4 ft.
9.9 ft. (3 m) Fixed Jib

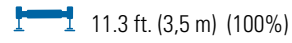

CAPACITIES APPLY TO OPERATION ON FIRM LEVEL SURFACES

	On Outriggers				On Rubber Static				On Rubber - 2.5 mph		
	360° Rotation		40° Front		360° Rotation		6° Front		Front		
	Lbs.	Tons	Lbs.	Tons	Lbs.	Tons	Lbs.	Tons	Lbs.	Tons	
MAIN BOOM	ft.	Max. 69° Min 12°		Max. 69° Min 12°		Max. 69° Min 12°		Max. 69° Min 12°		Max. 69° Min 12°	
	5	18,000	9.0	18,000	9.0	10,271	5.1	17,894	8.9	16,835	8.4
	6	17,153	8.6	17,153	8.6	8,894	4.4	15,565	7.8	14,612	7.3
	8	14,082	7.0	14,082	7.0	5,824	2.9	11,965	6.0	11,329	5.7
	10	11,753	5.9	11,859	5.9	3,918	2.0	8,788	4.4	8,788	4.4
	12	9,529	4.8	10,376	5.2	2,859	1.4	6,247	3.1	6,247	3.1
	14	7,094	3.5	9,212	4.6	2,118	1.1	4,765	2.4	4,765	2.4
	16	5,718	2.9	8,153	4.1	1,694	0.8	3,706	1.9	3,706	1.9
	18	4,765	2.4	6,776	3.4	1,376	0.7	2,965	1.5	2,965	1.5
	20	3,918	2.0	5,506	2.8	1,059	0.5	2,329	1.2	2,329	1.2
	22	3,388	1.7	4,659	2.3	847	0.4	2,012	1.0	2,012	1.0
MAIN BOOM + JIB	16	5,824	2.9	6,500	3.3						
	18	4,871	2.4	5,800	2.9						
	20	4,024	2.0	5,100	2.6						
	22	3,388	1.7	4,500	2.3						
	24	2,965	1.5	3,900	2.0						
	26	2,541	1.3	3,300	1.7						
	28	2,224	1.1	2,900	1.5						
	30	1,906	1.0	2,500	1.3						
32	1,694	0.8	2,300	1.2							

ON OUTRIGGERS

- The tabulated loads are the maximum loads covered by the manufacturer’s guarantees. The rated loads never exceed 85% of the tipping load. They are given in pounds and include the weight of hook blocks and other hoisting equipment. Their weight must be subtracted from the listed rated lifting capacity to obtain the net load that can be lifted (Also see page 7 for rated load deductions).
- The tires shall be raised clear of the ground and free of crane weight before operating boom or lifting loads.
- All outrigger beams must be extended to the same length; fully extended.
- The crane should be raised and positioned horizontally on outriggers.
- Operating at outrigger positions other than the above is neither intended nor approved.

ON TIRES

- The tabulated loads are the maximum loads covered by the manufacturer’s guarantees. The rated loads never exceed 75% of the tipping load. They are given in pounds and include the weight of hook blocks and other hoisting equipment. Their weight must be subtracted from the listed rated lifting capacity to obtain the net load that can be lifted (also see page 7 for rated load deductions).
- Crane lifting capacities require lifting from main boom head only on a smooth and level surface.
- Crane lifting capacities on tires depend on tire capacity, condition of the tires and tire air pressure. Tires must be inflated to the recommended pressure before lifting (see operator’s manual). The recommended pressures are indicated either in the cab or next to the wheels. When handling loads in the structural range with capacities close to maximum ratings, travel should be limited to “creep speed.” 2.5 mph capacities are permissible on main boom only, NOT on boom extension.
- For pick and carry operations, the boom must be centered over the front of the machine, the mechanical swing lock engaged and the load must be restrained from swing.
- Do not travel with boom extension erected. Creep: motion less than 200 feet in a 30 minute period and not exceeding 1 mph.

Data published herein is intended as a guide only. Crane operation is subject to the computer charts and operation manual supplied with the crane.

AREA OF OPERATION

On Outriggers

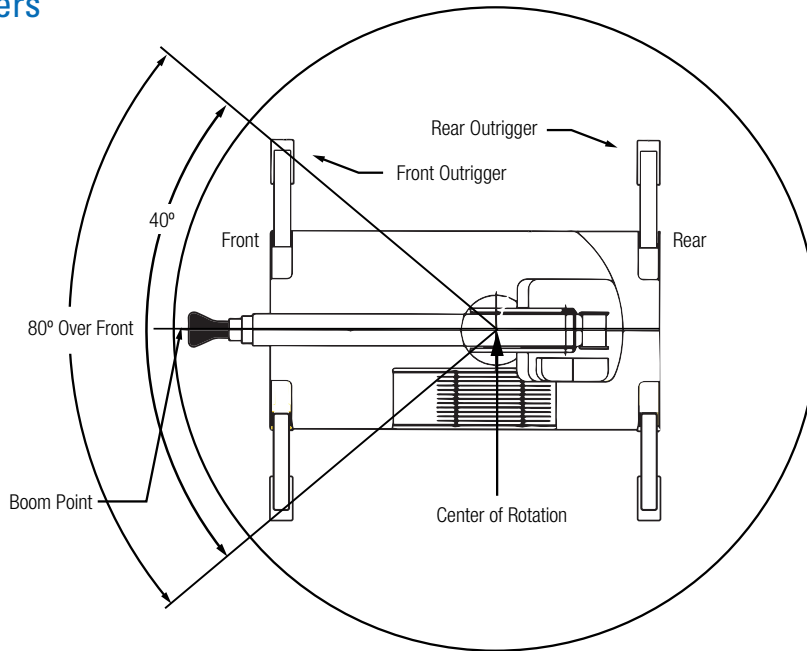

On Tires

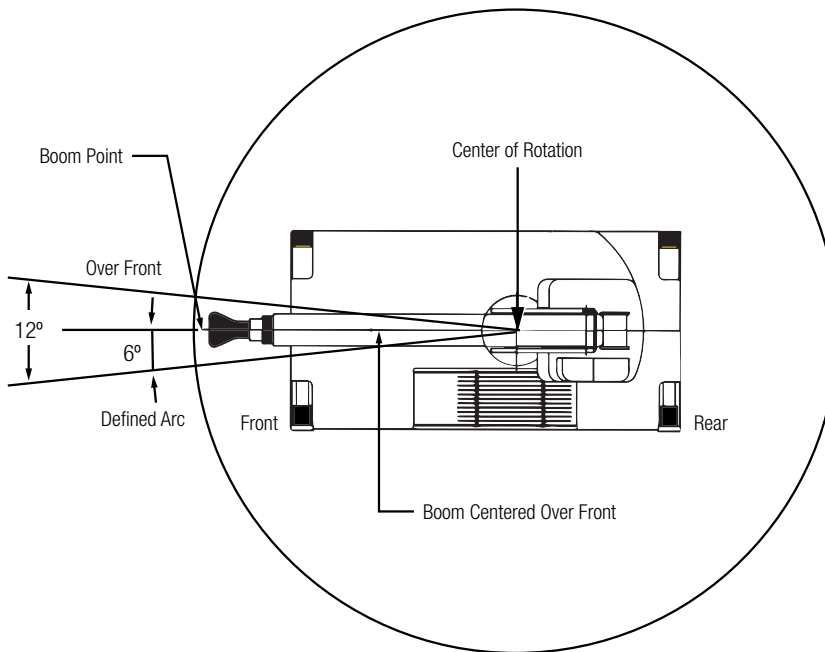

Deductions from rated loads for load handling devices supplied by Manitex

Downhaul weight & swivel hook (use with single part line)	110 lbs. (49.9 kg)
Sheave block	145 lbs. (65.7 kg)
9.85 ft. (3 m) extension	432 lbs. (195.9 kg)

WARNING: Lifting off the main boom point while the jib is erected is not intended or approved.

Data published herein is intended as a guide only. Crane operation is subject to the computer charts and operation manual supplied with the crane.

CRANE DIMENSIONS

Imperial & Metric Units

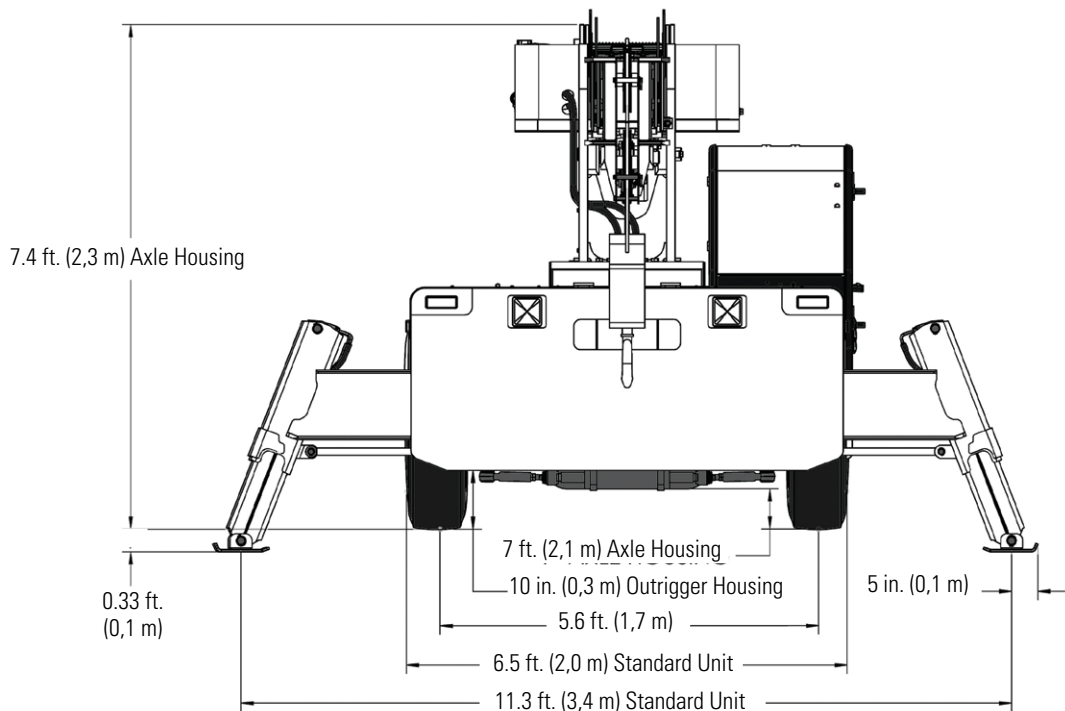
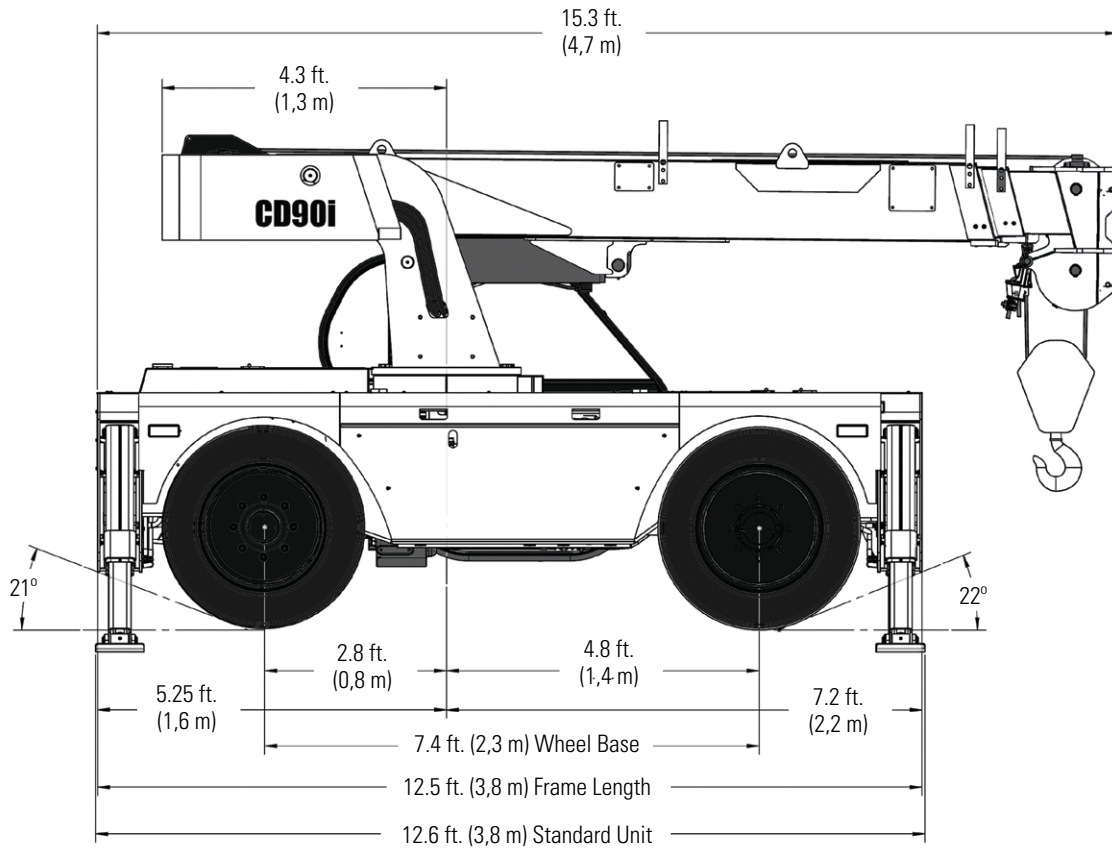

Data published herein is intended as a guide only. Crane operation is subject to the computer charts and operation manual supplied with the crane.

TECHNICAL DESCRIPTIONS

Boom



Boom length: 3-section 25.4 ft. (7,7 m)
2-sheave quick reeve boom point
Full power mechanically synchronized



Boom max. tip height: 33 ft. (10,1 m)



Boom angle (min/max): 0° / 69°

Rotation



Hydraulic driven worm gear and pinion



Slewing brake: Spring-applied hydraulic released brake
360° house lock - manually applied



Boom rotation: 360° continuous
Slewing speed: 1.6 - 2 rpm

Outriggers



Outriggers: Front and rear, all four corners
Style: Out-and-down, integral holding valve, outrigger pads
Controls: Five (5) 3-position direct hydraulic levers
Outrigger motion alarm
Fully extended:

- Front and rear
Center of pad: 11.3 ft. (3,5 m)

Electrical System



State-of-the-art, weather-resistant components throughout
Hermetically sealed enclosure includes power in relays and circuit status LEDs

Hoist, Rope and Hook



Maximum theoretical single line speed: (without load)

- 1st layer
51.5 fpm (0,26 mps)
- 2nd layer
56 fpm (0,28 mps)



Maximum line pull:

- Single line:
9,000 lbs. (4,082 kg)
- Double line:
18,000 lbs. (8,164 kg)



Line diameter: 0.56 in. (14,2 mm)



Line length: 3-section boom: 120 ft. (36,5 m)



Line type: 6 x 19 EIPS, right regular lay



Main winch: Gear motor drive with spring applied /hydraulic released brake
Drum diameter: 11.42 in. (0.29 m)



Downhaul weight & swivel hook:
110 lbs. (49.9 kg) - use with single part line

Vehicle Performance



Maximum speed: 17.9 mph (28.8 kph)



Maximum gradability: Vehicle may move on 25% slope at 0.4 mph (0,7 kph)

Tires



H16 Pneumatic 255/70 R22.5

TECHNICAL DESCRIPTIONS

Control System



Includes all crane functions and driving controls

Operator's Station



Frame mounted non-vibrating open style operator's control station

Standard features:

- Weather resistant seat
- Hour meter

Dash panel includes:

- Engine oil pressure gauge
- Engine water temperature gauge
- Fuel gauge
- Low battery, low oil, and high temp. warning lights

Hydraulics



Hydraulic pump: Dual gear pump
40 gpm (151.4 lpm) @ 2200 rpm

Hydraulic oil reservoir capacity: 50 gal. (189 L)

Maximum system operation pressure: 2000 psi

Return line filter with full flow by-pass protection and service indicator

Operator aids



Graphic interface for load indicator

Load Moment Indicator (LMI)

Anti-Two Block Device (ATB)

Rated Capacity Limiter (RCL)

Engine



PSI 2.4L Dual Fuel

Rated power: 60 hp (44.7 kW) @ 2300 rpm

Fuel type: Gas / LP

Fuel tank capacity: 16 gal. (60.6 L)

Drive-line



DANA synchromesh 4-speeds forward and 3 reverse with electrical steer model 1102FT12410

Steering



2-wheel, 4-wheel and crab steer with manual alignment

4x2-Front axle drive with planetary hubs and limited slip differential

Front: DANA 212 planetary steer with internal multi-wet-disc brakes and limited slip differential

Rear: Fabricated non-drive steer with disc brakes

Frame



High strength alloy steel constructed with integral outrigger housings: front and rear lifting, towing, and tie-down lugs.

Carry decks:

- Front: 23.2 ft² (2.15 m) with 6,620 lbs. (3,003 kg) carrying capacity
- Side right: 21.8 ft² (2.03 m) with 2,200 lbs. (998 kg) carrying capacity

Deck coated with anti-skid treatment.



Manitex
INDUSTRIAL CRANES



CD90i

9-ton (8,2 mt) CARRY DECK CRANE
PRODUCT GUIDE

UPTIME

UPTIME is the Manitex commitment to complete support of thousands of units working every day.

MANITEX

3000 South Austin Avenue
Georgetown, Texas 78626

1-877-314-3390 | www.Manitex.com