

General Specifications

Link-Belt® "ABS/API" Series Wire rope offshore cranes

Specifications applicable to ABS/API models . . .

48A, 78A, 108B, 138A, 218A, 238A

Maximum lifting crane capacities ^①			
Model		U.S. tons	metric tons
48A	ABS	18.40	16.69
	API	17.05	15.46
78A	ABS	35.25	31.97
	API	35.20	31.93
108B	ABS	40.85	37.05
	API	49.20	44.62
138A	ABS	64.95	58.91
	API	62.75	56.91
218A	ABS	88.20	79.99
	API	80.70	73.19
238A	ABS	114.30	103.67
	API	97.80	88.70

Figure 1

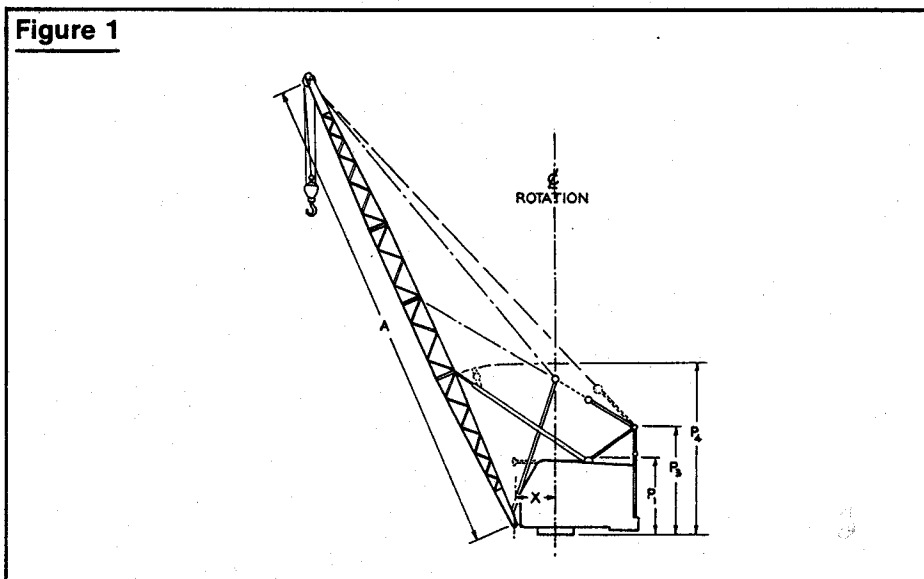

^①Crane ratings as indicated comply with structural safety factors of ABS or API Specifications 2-C.

General dimensions (Refer figure 1)			48A	78A	108B	138A	218A	238A
Basic angle boom length	A	Feet meters	25 7.62	35 10.67	40 12.19	50 15.24	50 15.24	50 15.24
Basic tubular boom length	A	Feet meters	← Not Offered →					
Overall height, low gantry ^①	P ₁	Feet meters	7' 1" 2.16	8' 2" 2.49	8' 6" 2.59	8' 1/2" 2.45	8' 1/2" 2.48	8' 8 1/2" 2.65
Overall height, retractable gantry raised ^①	P ₃	Feet meters	N/A	11' 4" 3.45	12' 0" 3.66	N/A	N/A	N/A
Overall height, boom live mast vertical ^①	P ₄	Feet meters	14' 4" 4.37	N/A	N/A	27' 11" 8.51	28' 2" 8.58	34' 8 1/2" 10.57
Radius of boom hinge pin	X	Feet meters	2' 8" 0.81	3' 1" 0.93	3' 2" 0.96	3' 2" 0.96	3' 6" 1.07	3' 6" 1.07
Height of boom hinge pin ^①	—	Feet meters	1' 7 3/4" 0.50	2' 3 3/4" 0.71	2' 5 1/4" 0.77	3' 7 1/8" 1.09	3' 2 1/4" 0.97	3' 2 3/4" 0.98

^① Measured from bottom of roller path mounting plate (78A and 108B) or from bottom of turntable bearing mounting base or mounting plate (48A, 138A, 218A, and 238A).

Figure 2

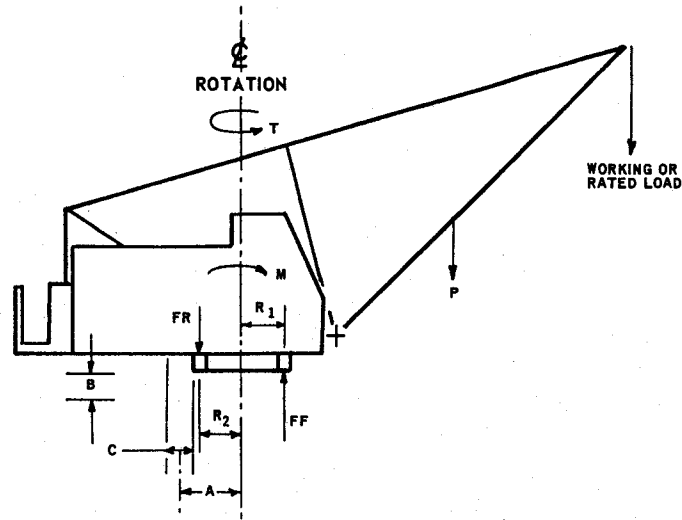

Maximum load values and reaction loadings — ABS models only

(Refer figure 2 above)			48A	78A	108B	138A	218A	238A
Front reaction	FF	Pounds kilograms	137,900 62 551	246,700 111 903	275,400 124 921	544,000 246 758	697,000 316 159	785,000 356 076
Rear reaction	FR	Pounds kilograms	88,300 40 053	170,500 77 339	198,600 90 085	360,000 163 296	472,000 214 099	510,000 231 336
Moment at centerline of rotation	M	Foot lbs. joules	362,000 490 872	752,600 1 020 526	980,700 1 329 829	1,871,000 2 537 076	2,513,000 3 407 628	2,783,000 3 773 748
Torsional load	T	Foot lbs. joules	27,600 37 426	41,500 56 274	59,600 80 818	60,200 81 631	76,900 104 276	91,600 124 210
Thrust	P	Foot lbs. joules	57,600 78 106	107,200 145 363	128,800 174 653	203,000 275 653	258,000 349 848	334,300 453 311
Reaction location	R ₁	Feet meters	1.60 0.49	1.82 0.55	2.08 0.63	2.08 0.63	2.16 0.66	2.16 0.66
Reaction location	R ₂	Feet meters	1.60 0.49	1.82 0.55	2.08 0.63	2.08 0.63	2.16 0.66	2.16 0.66

Maximum load values and reaction location — API models only

(Refer figure 2 above)			48A	78A	108B	138A	218A	238A
Front reaction	FF	Pounds kilograms	183,400 83 190	347,500 157 620	421,000 190 966	571,000 259 006	680,000 308 448	790,000 358 344
Rear reaction	FR	Pounds kilograms	132,400 60 057	221,000 100 246	263,400 119 478	470,000 213 192	569,000 258 098	645,000 292 572
Moment at centerline of rotation	M	Foot lbs. joules	504,800 684 509	985,400 1 336 202	1,420,500 1 926 198	2,129,000 2 886 924	2,673,000 3 624 588	3,075,000 4 169 700
Torsional load	T	Foot lbs. joules	27,600 37 426	41,500 56 274	59,600 80 818	60,200 81 631	76,900 104 276	91,600 124 210
Thrust	P	Foot lbs. joules	66,000 89 496	130,000 176 280	176,300 239 063	239,000 324 084	305,000 413 580	364,000 493 584
Reaction location	R ₁	Feet meters	1.60 0.49	1.82 0.55	2.08 0.63	2.08 0.63	2.16 0.66	2.16 0.66
Reaction location	R ₂	Feet meters	1.60 0.49	1.82 0.55	2.08 0.63	2.08 0.63	2.16 0.66	2.16 0.66

Minimum clearance dimensions — for removing vertical swing shaft

(Refer figure 2, page 2)			48A	78B	108B	138A	218A	238A
Centerline of rotation to centerline of swing shaft	A	Inches millimeters	16 406.4	19½ 495.3	21½ 546.1	38 965.2	41 1041.4	41 1041.4
Clearance under mounting plate required to remove vertical swing shaft	B	Inches millimeters	21½ 546.1	26 660.4	32 812.8	12½ 317.5	12¾ 323.9	15¾ 400.1
Diameter of swing pinion access opening	C	Inches millimeters	8 203.2	10½ 266.7	10 254.0	⊕	⊕	⊕

⊕ Not applicable — machine equipped with external ring gear and swing pinion.

Hook roller path mounting dimensions

(Refer figure 3 below)		78A		108B	
		Inches	millimeters	Inches	millimeters
Length and width of hook roller path mounting plate [⊕]	A	65¼ dia. 60 dia.	1 657.4 dia. 1 524.0 dia.	72 dia. 66 dia.	1 828.8 dia. 1 676.4 dia.
Hook roller path mounting plate thickness	B	1¼	31.8	1¼	31.8
Centerline of rotation to centerline of swing pinion access opening	C	19½	495.3	21½	546.1
Diameter swing pinion access opening	D	10½	266.7	10	254.0
Overall height of roller path	E	9 ²¹ / ₃₂	245.3	10¾	273.1
Overall height of roller path and mounting plate	F	10 ²⁹ / ₃₂	277.0	12	304.8

⊕ Upper figure indicates bolt-on unit; lower figure indicates weld-on unit.

Figure 3

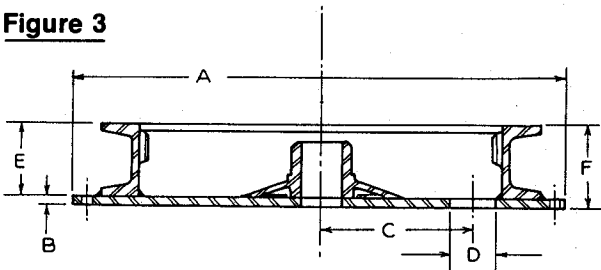

Turntable bearing mounting dimensions

(Refer figures 4 and 5 below)		48A [⊕]		138A [⊙]		218A [⊙]		238A [⊙]	
		In.	mm	In.	mm	In.	mm	In.	mm
Overall height turntable bearing mounting base	G	4¾	120.6	15¾	400.1	16	406.4	16	406.4
Diameter turntable bearing mounting base	H	42 ¹ / ₁₆	1 067.0	65¼	1 657.4	71	1 803.4	71	1 803.4
Diameter turntable bearing mounting plate	I	53	1 346.2	70	1 778.0	76¾	1 949.0	76¾	1 949.5
Turntable bearing mounting plate thickness	J	1½	38.1	2	50.8	2	50.8	2	50.8
Overall height turntable bearing only	K	3¾	95.3	6¾	161.9	6½	165.1	6¾	171.5
Overall height turntable bearing and mounting	L	8½	215.9	22 ¹ / ₈	562.0	22½	571.5	22¾	577.9
Diameter turntable bearing	M	48 ¹ / ₈	1 222.4	69	1 752.6	75	1 905.0	75	1 905.0
Centerline rotation to centerline of swing pinion access opening	N	16	406.4	⊕	—	⊕	—	⊕	—
Diameter swing pinion access opening	O	8	203.2	⊕	—	⊕	—	⊕	—

⊕ Not applicable — machine equipped with external ring gear and swing pinion.

⊙ Refer figure #4 below.

⊙ Refer figure #5 below.

Figure 4

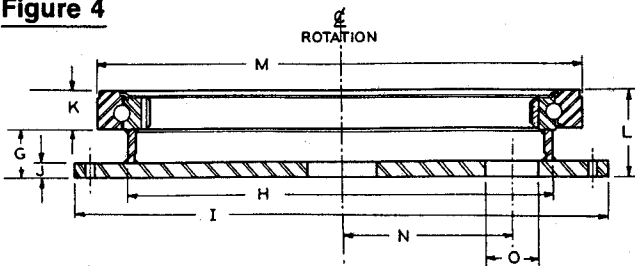

Model 48A

Figure 5

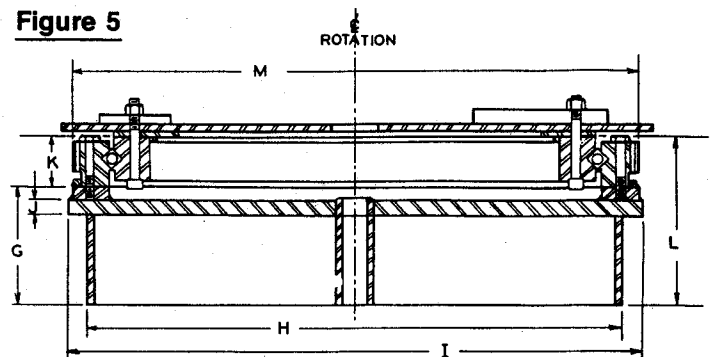

Models 138, 218 & 238

Dimensions of crane revolving upperstructure less boom

(Refer figure 6 below)			48A	78A	108B	138A	218A	238A
Overall length with catwalk	A	Feet meters	13' 10" 4.21	16' 10" 5.13	18' 3" 5.57	24' 1" 7.34	25' 7.62	25' 7.62
Overall width with catwalk	B	Feet meters	12' 3" 3.73	13' 0" 3.96	13' 2 1/4" 4.02	17' 3" 5.26	17' 3" 5.26	17' 3" 5.26
Tailswing of catwalk	C	Feet meters	11' 6" 3.51	13' 3" 4.04	14' 2" 4.32	16' 10" 5.13	17' 9" 5.41	17' 9" 5.41
Centerline rotation to outside of catwalk	D	Feet meters	6' 1 1/2" 1.87	6' 6" 1.98	6' 7 1/8" 2.05	8' 7 1/2" 2.63	8' 7 1/2" 2.63	8' 7 1/2" 2.63
Overall width without catwalk	E	Feet meters	7' 6" 2.29	7' 10" 2.38	8' 0" 2.44	11' 0" 3.35	11' 0" 3.35	11' 0" 3.35
Overall length without catwalk	F	Feet meters	11' 8 13/16" 3.57	14' 3 3/8" 4.35	15' 1 1/8" 4.60	22' 2 1/4" 6.76	22' 7 1/2" 6.90	23' 1 1/2" 7.05
Tailswing of counterweight only	G	Feet meters	8' 9" 2.67	10' 6 1/2" 3.21	11' 5" 3.48	14' 10 1/2" 4.53	15' 3 1/4" 4.66	15' 8 7/8" 4.79

Figure 6

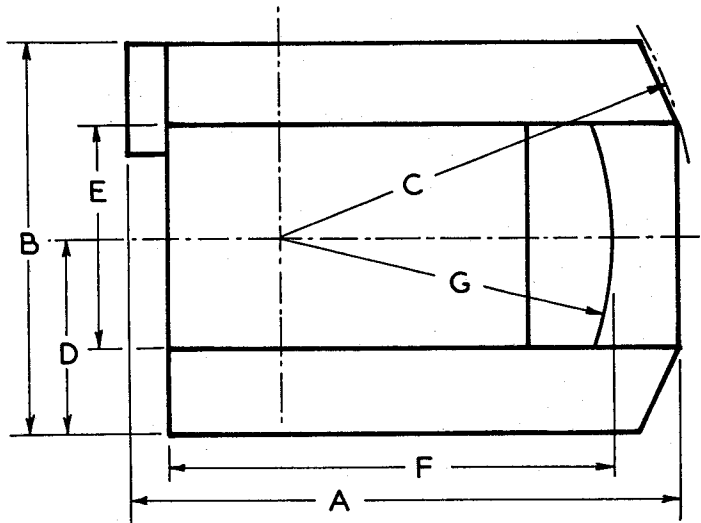

Gross operating weight —

	48A	78A	108B	138A [Ⓢ]	218A [Ⓢ]	238A
Pounds	22,410	40,485	51,675	64,400	73,900	108,700
kilograms	10 165	18 364	23 440	29 212	33 521	49 306

[Ⓢ]Add 12,000 lbs. (5 443 kg) with optional "B" counterweight.

General specifications

Revolving upperstructure



Frame

All-welded, stress relieved, precision machined.

Machinery side housings — All-welded, stress relieved, line or stub bored for positive shaft and gear alignment. Depending on specific model, side housings may be either fabricated integrally with upper frame or as separate units which bolt on machined surfaces on upper frame.

Mounting of upperstructure on supporting structure

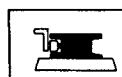

Hook roller path

Double-flanged, machined roller path with

integral ring (swing) gear; welded to mounting plate which can either be welded or bolted to supporting structure. Swing pinion meshes with ring (swing) gear. (Standard on 78A and 108B).

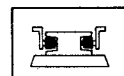

Hook rollers

Heat treated, conical hook-type rollers mounted on anti-friction bearings; shim adjusted to compensate for roller path or roller wear. Eight rollers mounted in four equalized pairs — two pairs front and rear. (Standard on 78A and 108B).

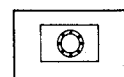

Turntable bearing

Complete with integral, external ring (swing)

gear. Inner race of bearing is bolted to revolving upperstructure; outer race with ring (swing) gear is bolted to mounting plate which is either fixed to a mounting base, which is in turn fixed to the supporting structure, or fixed direct to the supporting structure.

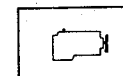

Engines

Diesel: full pressure lubrication, oil filter, oil cooler, air cleaner, fuel filter, hour meter, foot and hand throttles, and spark arrester exhaust system. Optional hydrostarter or air starter.

Engine specifications	48A	78A	108B	138A	218A	238A
Manufacturer Series	GM 3-53N	GM 3-71N	GM 4-71N	GM 6-71N [Ⓞ]	GM 6-71N [Ⓞ]	GM 6-71N [Ⓞ]
Number cylinders	3	3	4	6	6	6
Bore and stroke — inches — millimeters	3 3/8 x 4 1/2 98 x 114	4 1/4 x 5 108 x 127	4 1/4 x 5 108 x 127	4 1/4 x 5 108 x 127	4 1/4 x 5 108 x 127	4 1/4 x 5 108 x 127
Piston displacement — cubic inches — cm ³	159.2 2 609.3	212.7 3 486.2	283.7 4 649.8	425.6 6 975.6	425.6 6 975.6	425.6 6 975.6
High idle speed r.p.m.	2,100	1,990	1,990	1,950	1,950	2,040
Engine r.p.m. at full load speed	1,935	1,815	1,850	1,800	1,800	1,900
Net engine horsepower at full load speed — kilowatts	60 45	84 63	112 84	165 123	165 123	171 128
Peak torque — foot pounds — joules	164 222.38	271 367.48	351 475.96	1,400 1898.4	1,400 1898.4	1,400 1898.4
Peak torque r.p.m.	1,000	1,200	1,200	Converter stall	Converter stall	Converter stall
Electrical system	12-volt	12-volt	12-volt	12-volt	12-volt	12-volt
Batteries	2-6 volt	2-6 volt	2-6 volt	1-12 volt	1-12 volt	1-12 volt
Clutch or power take-off	Friction clutch	Friction clutch	Friction clutch	Disconnect between engine and converter [Ⓞ]	Disconnect between engine and converter [Ⓞ]	Disconnect between engine and converter [Ⓞ]
Transmission —	—	—	—	—	—	—
Number chain wheel teeth	123	161	161	161	161	171
Number engine pinion teeth	16	17	17	21	28	21

[Ⓞ]Allison single stage torque converter #TCD0-475.

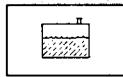

Fuel tank

Equipped with fuel gauge, flame arrestor, and filler pipe cap with locking eye for padlock.

Tank capacity	48A	78A	108B	138A	218A	238A
Gallons (U.S.)	20.5	43	58	75	75	75
Liters	78	163	220	284	284	284

Power train

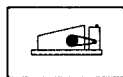

Transmission

FMC Link-Belt[®] roller chain (triple or quadruple strand depending on specific machine model) enclosed in oil tight chain case; pump driven oil stream lubrication with independent oil sump. Machine-cut teeth on engine pinion and chain wheel.

shafts. Drum gear/clutch drum assemblies bolted together and mounted on shafts on anti-friction bearings. Machine-cut teeth on drum gears, pinions, spur gears, and chain wheel.

includes constant displacement, engine driven, vane type hydraulic pump to provide flow of oil; accumulator to maintain system operating pressure, unloader valve to control pressure in accumulator, relief valve to limit maximum pressure buildup in system, full-flow filter with 40 micron disposable filter element, and variable pressure control valves to control drum clutches and other operating cylinders.

Principal operating functions

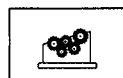

Machinery gear train

"Full-Function" design, two-directional power available to all operating shafts; shafts mounted on anti-friction bearings in precision bored machinery side housings. All load hoist, swing, and boomhoist functions independent of one another. Components such as gears, pinions, chain wheels, brake drums and clutch spiders involute splined to

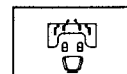

Control system

Speed-o-Matic[®] power hydraulic control system requiring no bleeding. Variable operating pressure transmitted to all two-shoe clutch cylinders as required. System

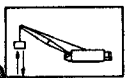

Load hoisting and lowering

Front and rear main operating drums gear driven; powered by chain transmission from engine.

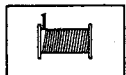

Load hoist drums

Front and rear main operating drums — Two-piece, removable, smooth or grooved laggings bolted to adapter which is splined to drum shaft. Extended length shafts permit installation of optional power load lowering clutches; special length shaft required for, and furnished with, optional planetary drive units for either or both drums.



Drum clutches

Load hoist clutches — Speed-o-Matic® power hydraulic two-shoe clutches; internal expanding, lined shoes. Clutch spiders splined to shafts; clutch drums bolted to drum spur gears and mounted on shafts on anti-friction bearings.

Load lowering clutches — Same style and type as load hoist clutches. Standard on front and rear drums of 48A, 78A, 108B. Standard on rear drum only, optional on front drum of 138A, 218A, 238A.

Drum planetary drive units — Optional; available for high speed load hoist (right side) on rear drum of 138A, 218A, 238A only. Planetary units mount on extended drum shafts between drum spur gears and two-shoe clutch drums. Two-shoe clutches control standard line speeds. Planetary drive

units controlled by external contracting band brakes through push button located on clutch control levers.

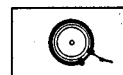

Drum brakes

Two-piece, external contracting band; brake drum involute splined to shaft. Mechanically foot pedal operated; foot pedal equipped with latch to permit locking brake in applied position.

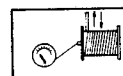

Drum rotation indicators

Standard for front and rear main operating drums. Two rotating dials mounted on control stand; dials actuated by flexible shaft drive from front or rear main operating drum.

Load hoist drum laggings	Root diameter	48A	78A	108B	138A	218A	238A
Front drum	Inches	8½ [Ⓢ]	12 [Ⓢ]	13¼ [Ⓢ]	14 [Ⓢ]	17¼ [Ⓢ]	17¼ [Ⓢ]
	meters	0.21	0.30	0.34	0.36	0.44	0.44
Rear drum	Inches	8½ [Ⓢ]	14 [Ⓢ]	13¼ [Ⓢ]	14 [Ⓢ]	17¼ [Ⓢ]	17¼ [Ⓢ]
	meters	0.21	0.36	0.34	0.36	0.44	0.44

Ⓢ Smooth Ⓢ Grooved

Load hoist clutches		48A	78A	108B	138A	218A	238A
Diameter of drum	Inches	14	18	20	18	20	23
	meters	0.36	0.46	0.51	0.46	0.51	0.58
Face width	Inches	3½	4½	5	4½	5	6
	millimeters	88.9	114.3	127.0	114.3	127.0	152.4

Load lowering clutches		48A	78A	108B	138A [Ⓢ]	218A [Ⓢ]	238A [Ⓢ]
Diameter of drum	Inches	14	18	20	18	20	23
	meters	0.36	0.46	0.51	0.46	0.51	0.58
Face width	Inches	3½	4½	5	4½	5	6
	millimeters	88.9	114.3	127.0	114.3	127.0	152.4

Ⓢ Optional on front drum.

Front and rear drum brakes		48A	78A	108B	138A	218A	238A
Diameter of brake	Inches	18	23	27	32	34	34
	meters	0.46	0.58	0.69	0.81	0.86	0.86
Face width	Inches	3	3¾	4½	4	4½	5
	millimeters	76.2	95.25	114.3	101.60	114.3	127.0
Effective lining area	Sq. Inches	137	215	309	327	392	432
	cm ²	88.3	1 385	1 994	2 110	2 526	2 788

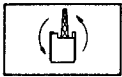

Swing system

Spur gear driven; single bevel gears on horizontal and vertical swing drive shafts enclosed and running in oil. Swing pinion involute splined to vertical swing shaft; meshes with teeth of swing (ring) gear.



Swing clutches

Speed-o-Matic® power hydraulic two-shoe clutches; lined shoes.

Swing brake — External contracting band; spring applied, hydraulically released by operator controlled lever.

Swing lock — Operator controlled, mechanical, double-tooth pawl engages teeth of swing (ring) gear.

Maximum swing speed (r.p.m.)	
48A — 4.8	138A — 3.4
78A — 4.2	218A — 3.0
108B — 4.0	238A — 2.8

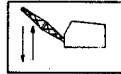

Boom hoist/ lowering system

Independent, spur gear driven. Precision control of boom hoisting and lowering. Speed-o-Matic® power hydraulic two-shoe clutches control boom hoisting on all models and boom lowering on 48A, 78A and 108B. Boom lowering on 138A, 218A and 238A controlled by low speed planetary drive unit. Optional — high speed power hydraulic two-shoe boom lowering clutch, in addition to low speed planetary drive unit, available on 138A, 218A and 238A.

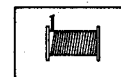

Boomhoist drum

See chart below for description and size.

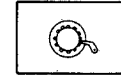

Boomhoist drum locking pawl

Operator controlled; mechanically applied and released. Engages ratchet ring which is integral with flange of boomhoist wire rope drum.

Swing clutches		48A	78A	108B	138A	218A	238A
Diameter of clutch	Inches	14	18	20	18	20	23
	meters	0.36	0.46	0.51	0.46	0.51	0.58
Face width	Inches	3½	4½	5	4½	5	6
	millimeters	88.9	114.3	127.0	114.3	127.0	152.4

Swing brake		48A	78A	108B	138A	218A	238A
Diameter of brake	Inches	12	11	14	18	20	20
	meters	0.30	0.28	0.36	0.46	0.51	0.51
Face width	Inches	2	2	2¼	3	3¼	3¼
	millimeters	50.8	50.8	57.2	76.2	82.55	82.55
Effective lining area	Sq. inches	59	47	74	130	154	154
	cm ²	381	303	477	837	994	994

Boomhoist drum		48A	78A	108B	138A	218A	238A
Drum design		Single [Ⓛ]	Single [Ⓛ]	Single [Ⓛ]	Single [Ⓢ]	Single [Ⓢ]	Single [Ⓢ]
Root diameter		7"	9"	9"	10½"	11¼"	12¼"
		0.18 m	0.23 m	0.23 m	0.27 m	0.29 m	0.31 m

ⓁGrooved ⓈSmooth

Boom hoist/lowering clutches		48A	78A	108B	138A	218A	238A
Boom hoist clutch — Diameter	Inches	14	18	20	18	20	23
	meters	0.36	0.46	0.51	0.46	0.51	0.58
Face width	Inches	3½	4½	5	4½	5	6
	millimeters	88.9	114.3	127.0	114.3	127.0	152.4
Boom lowering clutch — Diameter	Inches	14	18	20	Ⓛ	Ⓛ	Ⓛ
	meters	0.36	0.46	0.51	—	—	—
Face width	Inches	3½	4½	5	Ⓛ	Ⓛ	Ⓛ
	millimeters	88.9	114.3	127.0	—	—	—

ⓁLow speed planetary drive unit — standard.

Boomhoist brake		48A	78A	108B	138A	218A	238A
Diameter of brake	Inches	14	19	22	26	28	28
	meters	0.36	0.48	0.56	0.66	0.71	0.71
Face width	Inches	3	3	3	4	5	5
	millimeters	76.2	76.2	76.2	101.6	127.0	127.0
Effective lining area	Sq. Inches	107	151	174	275	234	372
	cm ²	690	974	1123	1775	1510	2401



Boom hoist/ lowering clutch

Speed-o-Matic® power hydraulic two-shoe clutches; internal expanding, lined shoes. (See chart page 7.)



Boom hoist brake

Single external contracting band brake; spring applied, hydraulically released. Brake drum involute splined to shaft. (See chart page 7.)

Boomhoist limiting device — Provided to restrict hoisting boom beyond recommended minimum radius; located on exterior right hand side of operator's cab.

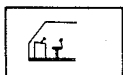

Operators cab

Full-vision, equipped with safety glass panels. Standard equipment includes dry chemical fire extinguisher, adjustable cushioned seat with head and arm rests. Optional available equipment — sound reduction material, air operated windshield wiper.



Machinery cab

Equipped with warning horn, doors on sides and rear for machinery access, roof-top access ladder, hand/grab rails, and skid-resistant finish on roof.

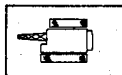

Catwalks

Optional — available along operator's side, both sides of cab, and/or across rear of cab — depending on specific machine model (refer to price lists). Fabricated steel with extruded metal floor grating and hand railings.

Gantry — Fixed low; mounted to revolving upperstructure frame — standard on ABS/API-48A only.

Fixed low; mounted at top rear of machinery side housings — standard on ABS/API-138A, 218A and 238A.

Supports boom suspension system.

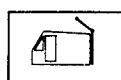

Gantry

Retractable high; mounted at top and rear of cab — standard on ABS/API-78A and ABS/API-108B.

Supports boom suspension system.

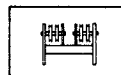

Gantry bail

Mounted to gantry head shaft; supports boom suspension system. Equipped with sheaves, mounted on anti-friction bearings, to accommodate boomhoist reeving. (See chart below.)

Gantry bail	48A	78A	108B	138A	218A	238A
Number bail sheaves	4	4	5	6	8	7
Sheaves root diameter	8" (0.20 m)	12" (0.30 m)	12" (0.30 m)	12" (0.30 m)	12" (0.30 m)	15" (0.38 m)
Number parts of wire rope in boomhoist reeving	10	10	10	14	16	16



Counterweight

Counterweight	48A	78A	108B	138A	218A	238A
Number pieces	One	One	One	Two [Ⓞ]	Two [Ⓞ]	Two
Pounds	9,200	13,200	19,200	30,000	33,000	47,000
kilograms	4 173	5 988	8 709	13 608	14 969	21 319

[Ⓞ]Includes 12,000 lbs. (5 443 kg) optional "B" counterweight.

Boom



Angle boom

Boom	48A	78A	108B	138A	218A	238A
Basic length	25' 7.62 m	35' 10.67 m	40' [Ⓞ] 12.19 m	50' 15.24 m	50' 15.24 m	50' 15.24 m
Maximum length	80' 24.38 m	100' 30.48 m	100' 30.48 m	150' 45.72 m	150' 45.72 m	150' 45.72 m
Type connections	Bolted	Bolted	Bolted	Bolted	Bolted	Bolted
Main chords — Type	Angle	Angle	Angle	Angle	Angle	Angle
Size	2½"x2½"x¼" 63.5x63.5x 6.4 mm	3"x3"x¾" [Ⓞ] 76.2x76.2x 9.5 mm	3½"x3½"x¾" [Ⓞ] 88.9x88.9x 9.5 mm	4"x4"x¾" 101.6x101.6x 9.5 mm	4"x4"x¾" 101.6x101.6x 9.5 mm	4"x4"x¾" 101.6x101.6x 9.5 mm
Boompoint sheaves — Number	3	4	3 [Ⓞ]	3 [Ⓞ]	3 [Ⓞ]	3 [Ⓞ]
Root diameter	12" 0.30 m	18" 0.46 m	18" 0.46 m	21" 0.53 m	21" 0.53 m	21" 0.53 m

[Ⓞ]34" x 34" (0.86 x 0.86 m) angle boom.

42" x 42" (1.07 x 1.07 m) pin-connected angle boom with 4" x 4" x 5/16" (101.6 x 101.6 x 7.94 mm) main chords is optional for ABS or API-108B.

[Ⓢ]Base section only. Top section and extensions have 3" x 3" x 5/16" (76.2 x 76.2 x 7.9 mm) main chords.

[Ⓣ]Base section only. Top section and extensions have 3½" x 3½" x 5/16" (88.9 x 88.9 x 7.9 mm) main chords.

[Ⓤ]42" x 42" (101.6 x 101.6 mm) angle boom equipped with three 18" (0.46 m) diameter boompoint sheaves.

[Ⓟ]Four or five 21" (0.53 m) root diameter boompoint sheaves optional.



Boom stops

Dual, rigid type with spring loaded bumper ends; mounted on cab roof — standard on ABS/API-48A.

Dual tubular, lever type with spring loaded bumper ends — standard on ABS/API-78A, 108B, 138A, 218A, 238A.

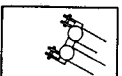

Boomhoist bridle

Serves as connection between boom pendants and boomhoist wire rope reeving. Equipped with sheaves mounted on anti-friction bearings.

Boomhoist bridle

Model	Number sheaves	Root diameter
48A	5	8" (0.20 m)
78A	5	11" (0.28 m)
108B [Ⓞ]	5	10¼" (0.26 m)
138A	7	12" (0.30 m)
218A	8	12" (0.30 m)
238A	8	15" (0.38 m)

[Ⓞ]For ABS/API-108B 34"x34" (0.86x0.86 m) angle boom only.
ABS/API-108B 42"x42" (1.07x1.07 m) angle boom is equipped with 5 12" (0.30 m) sheaves.

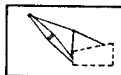

Boom live mast

Mounts on front of frame near boom feet. Supports boomhoist bridle and boomhoist wire rope reeving.



Boom angle indicator

Pendulum type, mounted on boom base section.

Boom tip extension — Fabricated steel, equipped with single sheave mounted on anti-friction bearings. 48A-tip extension 8'0" (2.44 m) long, 5,000 lbs. (2 268 kg) maximum capacity. 78A, 108B, 138A, 218A, 238A-tip extension 10'0" (3.05 m) long, 10,000 lbs. (4 536 kg) maximum capacity.

Boom tip extension sheaves	
Model	Root diameter
48A	12" (0.30 m)
78A	17⅞" (0.45 m)
108B	17⅞" (0.45 m)
138A	17⅞" (0.45 m)
218A	17⅞" (0.45 m)
238A	17⅞" (0.45 m)