

BT 3063

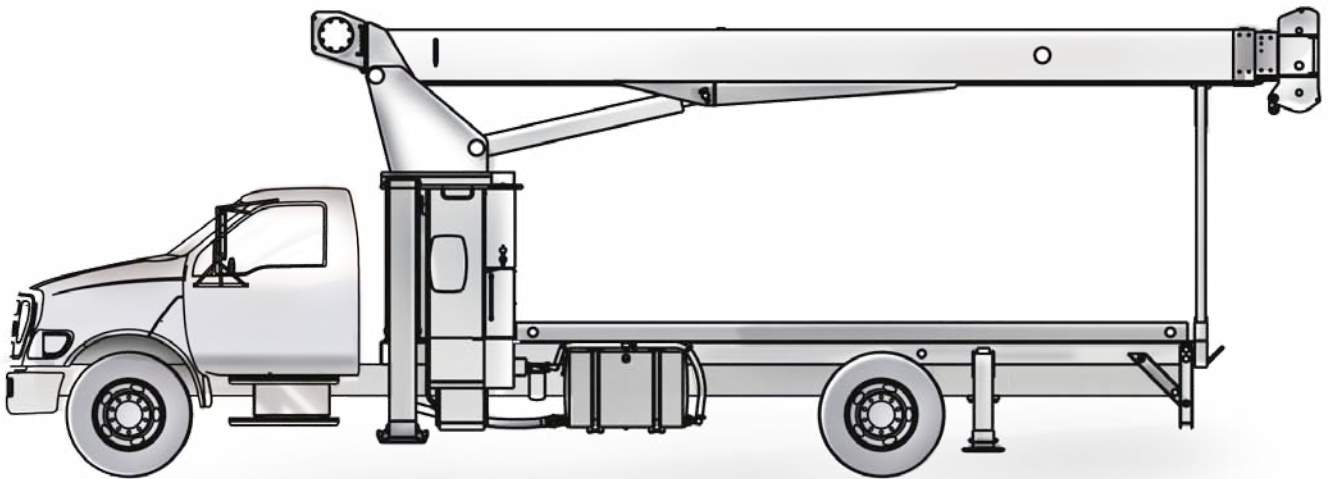

Features

- ▶ 15 t @ 5 ft capacity at rated distance from center of rotation
- ▶ 63 ft maximum boom length
- ▶ 73 ft maximum sheave height
- ▶ 24/40 ft optional jib
- ▶ 113 ft maximum sheave height with 40 ft jib
- ▶ Electronic load moment indicator
- ▶ Quick reeving boom head

Key

..... 3

Dimensions

Crane Dimensions 4, 5
Area of Operation 5
Mounting Specifications 5
Range Diagram 6

Load charts

Boom Load Charts 7
Jib, Retracted 7
Jib, Extended 7

Technical description

Boom, Jib and Rotation 8
Operator Controls 8, 9
Understructure 9
Optional Features 9

	Main boom		Main Hoist
	Boom length		Hoist line speed
	Tip height		Part line
	Telescoping mode		Operator aid
	Boom angle		Controls
	Working radius		Hydraulics
	Boom with jib		Working temperature
	Boom head		Outriggers
	Hook block		Working speeds
	Hook to head sheave pin		Rope – Standard / Optional
	Rotation / Allowable rotation range		Rope diameter
	Boom angle		Rope length
	Boom over the rear		Line pull

DIMENSIONS

BT 3063

Crane Dimensions

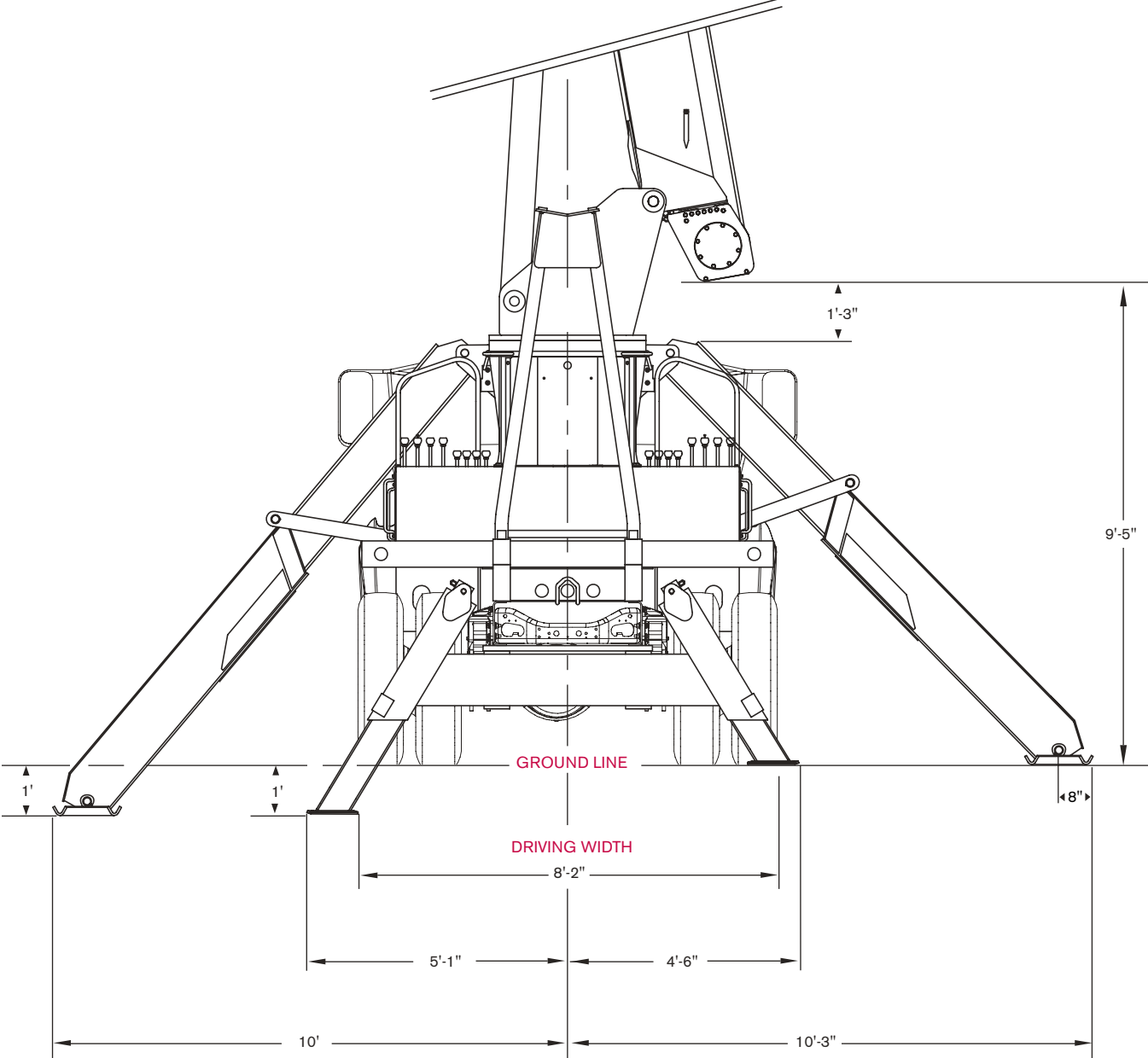

DIMENSIONS

BT 3063

Crane Dimensions

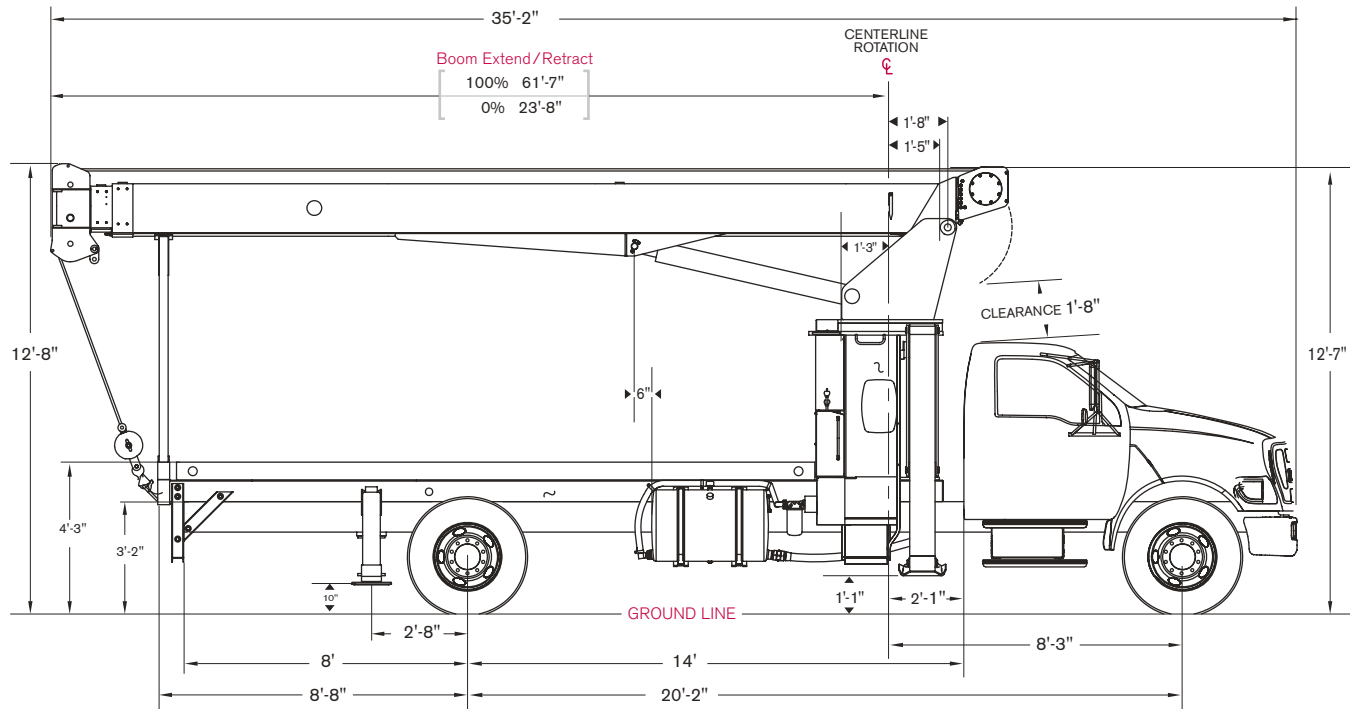

Area of Operation

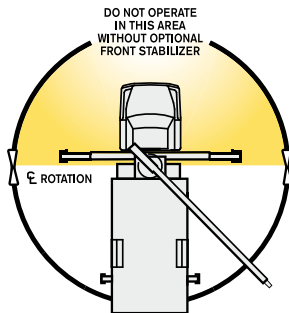

Mounting Specifications

Chassis recommendation

Combined axle weight rating	33,000 lb
Front axle weight rating	12,000 lb
Rear axle weight rating	21,000 lb
Crane weight	14,050 lb
Wheelbase	242 +/- 4 in
Cab to axle	168 +/- 4 in
Afterframe	100 +/- 4 in
Frame height (unloaded)	40 +/- 3 in
RBM per frame rail	1,400,000 lb/in
Exhaust	Vertical, left side

RANGE DIAGRAM

BT 3063

Outriggers Fully Extended (100%)

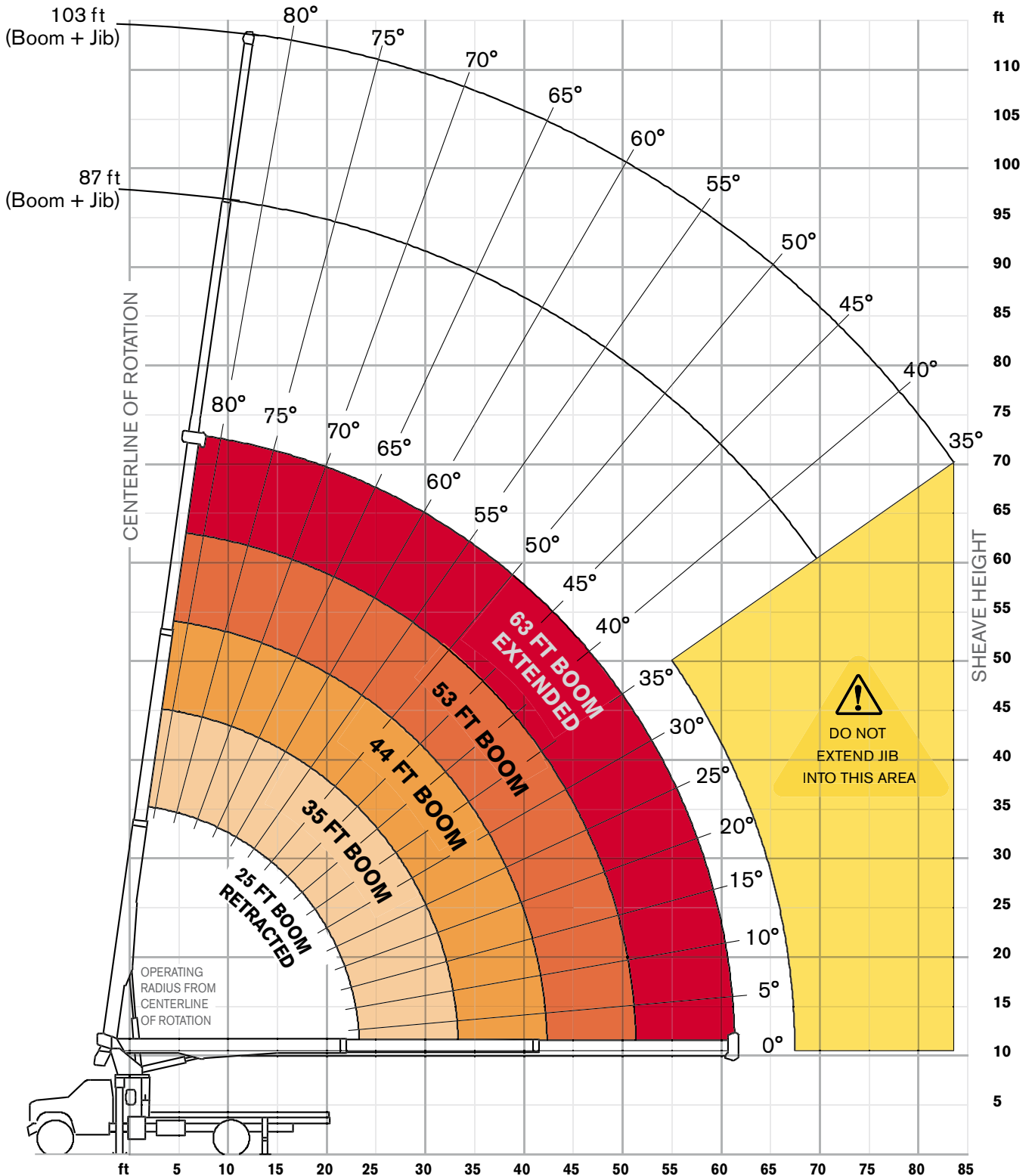
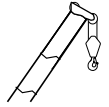



BOOM LOAD CHARTS

BT 3063

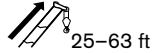
Outriggers Fully Extended (100%)





Standard ASME B30.5

	Boom Length					
	25	35	44	53	63	
ft	lb	lb	lb	lb	lb	ft
5	30,000					5
8	20,150	15,800	15,625			8
10	17,050	14,750	14,300	12,600		10
12	14,650	12,650	12,200	11,875	9,500	12
15	12,125	10,475	10,050	9,700	8,200	15
20	8,900	8,050	7,725	7,400	6,800	20
25		6,400	6,075	5,975	5,575	25
30		4,875	4,975	4,750	4,475	30
35			4,100	4,000	3,725	35
40			3,100	3,325	3,100	40
45				2,775	2,600	45
50				2,200	2,250	50
55					1,900	55
60					1,450	60

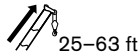
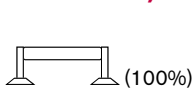
With Jib, Retracted and Extended



Standard ASME B30.5

	Jib Capacities for All Boom Lengths										
	35°	40°	45°	50°	55°	60°	65°	70°	75°	80°	
ft	lb	lb	lb	lb	lb	lb	lb	lb	lb	lb	ft
24	700	825	1,000	1,150	1,340	1,600	1,900	2,300	3,100	4,160	24
40	520	580	650	730	810	930	1,080	1,400	1,810	2,260	40

Notes to lifting capacity









Lifting capacities do not exceed 85% of tipping load. Weight of hook blocks and slings is part of the load, and is to be deducted from the capacity ratings. Consult operation manual for further details.

Note: Data published herein is intended as a guide only and shall not be construed to warrant applicability for lifting purposes. Crane operation is subject to the computer charts and operation manual both supplied with the crane.

TECHNICAL DESCRIPTION

BT 3063

Boom, Jib and Rotation

	Three-section full power fully synchronized telescopic keel boom	
	Boom length	25–63 ft
	Boom maximum sheave height	73 ft
	Boom elevation angle range (min/max)	-8° / 82°
	Boom up/down time	25/16 seconds
	Boom extension/retraction time	54/26 seconds
	Boom head	Quick reeving
	Maximum tip height: boom with jib 24/40 ft	113 ft
	180 degree non-continuous rotation or 370 degree optional continuous rotation	

Operator Controls

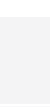
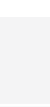
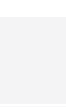
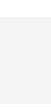
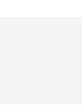
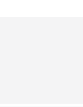
	Hoist line pull	11,400 lb
	Hoist line speeds (3rd layer)	186 ft/min
	Rope diameter	9/16 in
	Breaking strength	33,600 lb
	Permissible line pull	10,500 lb
	Overhaul ball	7 t
	1 sheave block	17.5 t
	1 part line	10,500 lb / 186 ft/min
	2 part line	21,000 lb / 93 ft/min
	3 part line	30,000 lb / 62 ft/min



Fully proportional
Independent outrigger controls



Electronic load indicator

Understructure



Front: Link type
To outer edge of pad

20 ft 5 in

Rear: A-Frame
To outer edge of pad

10ft 2 in

Optional Features

- Two-stage jib
- Rotation resistant rope
- Multi-part load blocks
- Main hoist with 2 speed motor
- Heavy duty wood flatbeds
- Extra heavy duty wood flatbeds
- Extra heavy duty steel flatbeds
- Radio remote controls
- One-man or two-man baskets
- Hoist drum tensioner
- Continuous rotation
- Oil cooler
- Single front bumper outrigger
- Hydraulic hose reel
- Tool box

www.terexcranes.com

Effective Date: November 2010. Product specifications and prices are subject to change without notice or obligation. The photographs and/or drawings in this document are for illustrative purposes only. Refer to the appropriate Operator's Manual for instructions on the proper use of this equipment. Failure to follow the appropriate Operator's Manual when using our equipment or to otherwise act irresponsibly may result in serious injury or death. The only warranty applicable to our equipment is the standard written warranty applicable to the particular product and sale and Terex makes no other warranty, express or implied. Products and services listed may be trademarks, service marks or trade-names of Terex Corporation and/or its subsidiaries in the USA and other countries. All rights are reserved. Terex® is a registered trademark of Terex Corporation in the USA and many other countries. Copyright 2010 Terex Corporation..

Terex Cranes, Global Marketing, Dinglerstraße 24, 66482 Zweibrücken, Germany
Tel. +49 (0) 6332 830, Email: info.cranes@terex.com, www.terexcranes.com

Brochure Reference: TC-DS-I-E-BT 3063-11/10



WORKS FOR YOU.™