

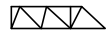

- SK1700 - 1.70x1.70 m
- SN2050 - 2.05x2.05 m

H=Altezza sotto gancio
H=Height under hook
H=Hauteur sous crochet

SK1700

 45 m —→ 65 m

Torre/Masts/Mat/Maste/Mästil/Tramo															
TRO	H[m]	4f/4f BF117	4f/4f BF052	4f/4f BF039	4f/2f SB117	4f/2f SB052	4f/2f SB039	2f/2f ST117	2f/2f ST052	2f/2f ST039	2f/2f STB117	2f/2f STB039	2f/2f RA039	4f/2f SBB039	4f/2f SBB117
	39				1			2		1					
	36.4					1			6						
TTD															
	* 39											8	1	1	
	* 39											6	1		1

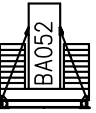
Torre/Masts/Mat/Maste/Mästil/Tramo															
CAF	H[m]	4f/4f BF117	4f/4f BF052	4f/4f BF039	4f/2f SB117	4f/2f SB052	4f/2f SB039	2f/2f ST117	2f/2f ST052	2f/2f ST039	2f/2f STB117	2f/2f STB039	2f/2f RA039	4f/2f SBB039	4f/2f SBB117
	44.2				1			2		1					
	41.6					1			6						
	* 44.2											8	1	1	
	* 44.2											6	1		1

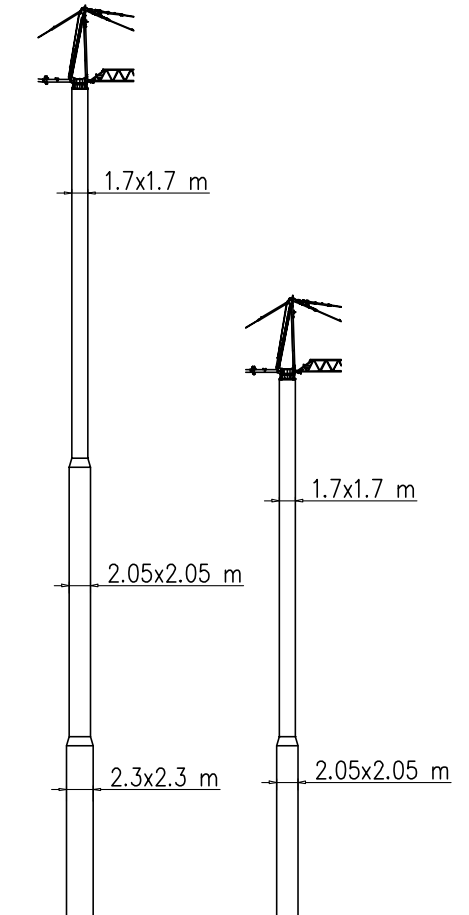

H=0–45 m	
R1	
R2	106 t
R3	95 t
M	336 tm

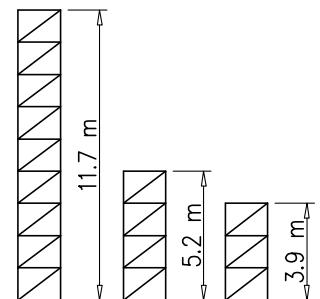

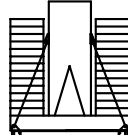

Peso zavorra – Ballast weight – Poids du lest – Ballastgewicht – Peso de lastre

	H	Tot.
	0–45 m	105600 kg

Torre/Reazioni – Masts/Reactions – Mat/Réactions – Maste/Eckdrücke – Mästil/Reacciones – Tramo/Reacções

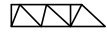
SN2050

 45 m —→ 65 m

Torre/Masts/Mat/Maste/Mästil/Tramo															
	H[m]	4f/4f BF117	4f/4f BF052	4f/4f BF039	4f/2f SB117	4f/2f SB052	4f/2f SB039	2f/2f ST117	2f/2f ST052	2f/2f ST039	2f/2f STB117	2f/2f STB039	2f/2f RA039	4f/2f SBB039	4f/2f SBB117
TRO															
	63.7	1	1		1			3							
	62.4		4			1			7						
TTD	57.2	1	1			1		1		6					
															
	63.7		4									9	1	1	
	63.7	1	1									8	1		1

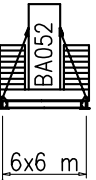
Torre/Masts/Mat/Maste/Mästil/Tramo															
	H[m]	4f/4f BF117	4f/4f BF052	4f/4f BF039	4f/2f SB117	4f/2f SB052	4f/2f SB039	2f/2f ST117	2f/2f ST052	2f/2f ST039	2f/2f STB117	2f/2f STB039	2f/2f RA039	4f/2f SBB039	4f/2f SBB117
	68.9	1	1		1			3							
	67.6		4			1			7						
	63.7	1	1			1				6					
	68.9		4									9	1	1	
	68.9	1	1									8	1		1

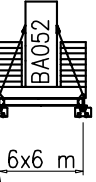
Torre/Masts/Mat/Maste/Mästil/Tramo															
	H[m]	4f/4f BF117	4f/4f BF052	4f/4f BF039	4f/2f SB117	4f/2f SB052	4f/2f SB039	2f/2f ST117	2f/2f ST052	2f/2f ST039	2f/2f STB117	2f/2f STB039	2f/2f RA039	4f/2f SBB039	4f/2f SBB117
	61.1	1	1		1			2		1					
	59.8		4			1			7						
	58.5	1	1			1				8					
	61.1		4									7	1	1	
	61.1	1	1									6	1		1

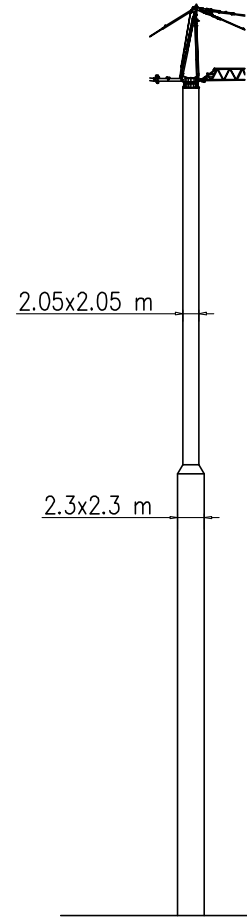

H=0–45 m		H=46–68 m	
R1	125 t	R1	140 t
R2	130 t	R2	144 t
R3	95 t	R3	103 t
M	486 tm	M	570 tm





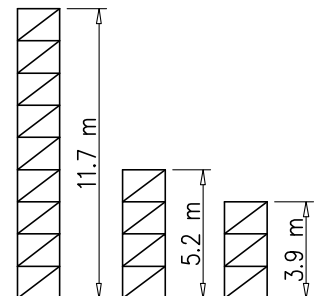

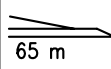

Peso zavorra–Ballast weight–Poids du lest
Ballastgewicht–Peso de lastre

H	Tot.
0–55 m	102320 kg
56–69 m	112460 kg

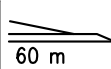

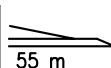

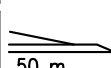

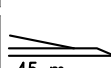

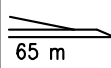

Curve di carico – Courbes de charges – Load diagrams – LastKurven – Curvas de cargas

Pmax 6000 kg

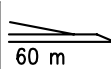
	31240 kg		65 m	3.5	30	34	36	38	40	42	44	46	48	50	52	54	56	58	60	62	65	m
				6000	6000	5300	4900	4500	4200	3900	3700	3500	3400	3200	2900	2800	2700	2600	2100	1800	1700	kg
	31240 kg		60 m	3.5	30	34	36	38	40	42	44	46	48	50	52	54	56	58	60			m
				6000	6000	5300	4900	4500	4200	3900	3700	3500	3400	3200	2900	2800	2700	2600	2500			kg
	28400 kg		55 m	3.5	33	34	36	38	40	42	44	46	48	50	52	54	55					m
				6000	6000	5900	5500	5000	4700	4400	4000	3800	3600	3500	3300	3200	3000					kg
	25560 kg		50 m	3.5		35	36	38	40	42	44	46	48	50								m
				6000		6000	5700	5200	4900	4600	4300	4000	3700	3500								kg
	22720 kg		45 m	3.5		35	36	38	40	42	44	45										m
				6000		6000	5700	5200	4900	4600	4300	4000										kg

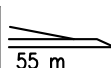

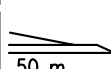



Pmax 12000/6000 kg



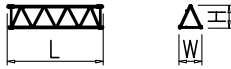
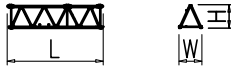
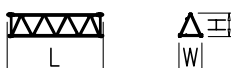
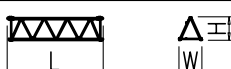
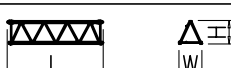
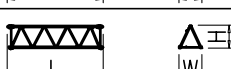
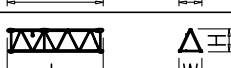
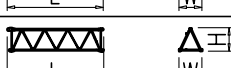
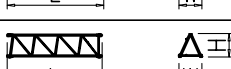
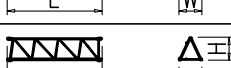

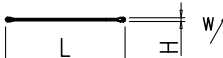
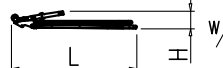
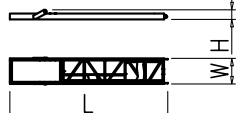
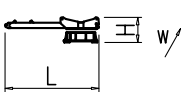



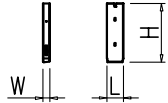

	31240 kg		65 m	3.5	16	20	24	28	30	34	36	38	40	42	44	46	48	50	52	54	56	58	60	62	65	m
				12000	9800	8100	6800	6000	5300	4900	4500	4200	3900	3700	3500	3400	3200	2900	2800	2700	2600	2100	1800	1700		kg
	31240 kg		60 m	3.5	16	20	24	28	30	34	36	38	40	42	44	46	48	50	52	54	56	58	60			m
				12000	9800	8100	6800	6000	5300	4900	4500	4200	3900	3700	3500	3400	3200	2900	2800	2700	2600	2500				kg
	28400 kg		55 m	3.5	16	20	24	28	30	34	36	38	40	42	44	46	48	50	52	54	55					m
				12000	10000	9000	7600	7000	5900	5500	5000	4700	4400	4000	3800	3600	3500	3300	3200	3000						kg
	25560 kg		50 m	3.5	18	20	24	28	30	34	36	38	40	42	44	46	48	50								m
				12000	11500	9700	8200	7300	6100	5700	5200	4900	4600	4300	4000	3700	3500									kg
	22720 kg		45 m	3.5	18	20	24	28	30	34	36	38	40	42	44	45										m
				12000	11500	9700	8200	7300	6100	5700	5200	4900	4600	4300	4000											kg

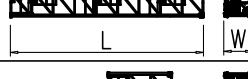

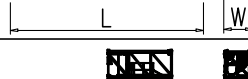
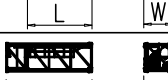
PESI E INGOMBRI – PACKING LIST – LISTE DE COLISAGE – GEWICHT UND ABMESSUNGEN

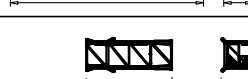
Denominazione Description	Disegno Draw	Pezzi Pieces	Dimensioni-Dimensions (mm)			Peso-Weight (kg)		
			L	W	H	Unit	Total	
Elemento di braccio Jib element Elément de èche Elemento de flecha	n°1 	1	5760	1440	1600	1100	–	
	n°2 	1	5820	1400	1470	820	–	
	n°3 	1	5860	1400	1470	840	–	
	n°4 	1	5860	1400	1470	780	–	
	n°5 	1	5860	1400	1470	740	–	
	n°6 	1	5850	1400	1470	720	–	
	n°7 	1	5820	1400	1470	720	–	
	n°8 	1	5820	1400	1470	760	–	
	n°9 	1	5850	1400	1450	700	–	
	n°10 	1	5740	1400	1450	520	–	
	n°11 	1	5770	1400	1450	500	–	
	n°12 	1	4350	1400	1450	390	–	
	Punta 	1	800	1400	1400	170	–	
Tirante completo Complete tie rod Tirant complète Tirante completo		12	6500	200	200	240	3540	
Cuspide Cusp Pointre Cùspide		1	8300	1500	1000	2900	–	
Contorbraccio completo Complete counterjib Contreflèche complète Contraflecha completa		1	9300	1650	600	2000	–	
Gruppo girevole Slewing group Table tournante Grupo giratorio		SK1700	1	5100	1810	1400	6500	–
		SN2050	1	5100	1810	1400	6800	–
Carrello Trolley Chariot Carretilla		1	1900	1620	1000	400	–	
Ballatoio con cabina Access balcony with cabin Porte cabine Balcón corrido con cabina		1	2500	2150	2450	1000	–	

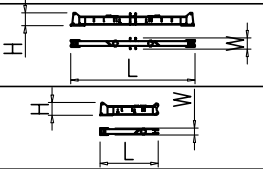
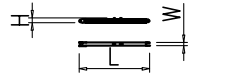
PESI E INGOMBRI – PACKING LIST – LISTE DE COLISAGE – GEWICHT UND ABMESSUNGEN

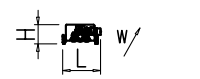
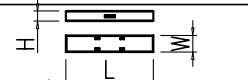
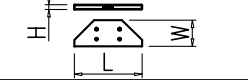
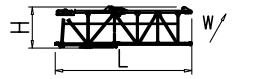
Denominazione Description	Disegno Draw	Pezzi Pieces	Dimensioni-Dimensions (mm)			Peso-Weight (kg)		
			L	W	H	Unit	Total	
Blocchi contrappeso Counterweight block Contre-poids Bloques de contrapeso	VX28 	11	1100	280	3700	2840	31240	
Elemento di torre Mast element Elément de mature Elemento de torre	ST039 	SK1700	-	3900	1785	1785	1750	-
		SN2050	-	3900	2110	2110	2320	-
	ST052 	SK1700	-	5200	1785	1785	2250	-
		SN2050	-	5200	2110	2110	2850	-
	ST117 	SK1700	-	11700	1785	1785	4690	-
		SN2050	-	11700	2110	2110	5790	-
	SB039 	SK1700	-	3900	1785	1785	2100	-
		SN2050	-	3900	2110	2110	2710	-
	SB052 	SK1700	-	5200	1785	1785	2600	-
		SN2050	-	5200	2110	2110	3350	-
SB117 	SK1700	-	11700	1785	1785	4830	-	
	SN2050	-	11700	2110	2110	7000	-	
BF039 	SK1700	-	3900	1785	1785	2450	-	
	SN2050	-	3900	2110	2110	3370	-	
BF052 	SK1700	-	5200	1785	1785	3390	-	
	SN2050	-	5200	2110	2110	3880	-	
BF117 	SK1700	-	11700	1785	1785	6920	-	
	SN2050	-	11700	2110	2110	8180	-	
Elemento di base Base element Mat de base Elemento de base	BA052 	SK1700	1	5200	2060	2060	3650	-
		SN2050	1	5200	2260	2260	4040	-
Carro di base Base carriage Chassis de base Cruceta de base		5x5	1	7550	670	780	2300	2300
		6x6	1	8870	670	780	2500	2500
		5x5	2	3530	420	780	1060	2120
		6x6	2	4320	420	780	1200	2400
Puntoni di base Rafter Jambes de force Cabrios de base		5x5	4	4250	240	300	280	1120
		6x6	4	4560	420	300	420	1680
Elemento a perdere Disposable frame Chassis a perdre Bastidor desechable		SK1700	1	1840	1910	1910	1430	-
		SN2050	1	2600	2260	2260	2030	-
Elemento recuperabile Recoverable frame Chassis récupérable Bastidor recuperable		SK1700	1	1300	2170	2170	1720	-
		SN2050	1	1300	2620	2620	1860	-
Bogie di traslazione Driven bogie Boggie motorisée Balancin de traslaciòn		4	1160	700	600	700	2800	
Blocco zavorra di base Base ballast block Lest de base Blaque de lastre		5x5	2	5300	1000	600	7300	14600
		6x6	2	6400	1200	600	10600	21200
		5x5	-	4100	1600	300	3500	-
		6x6	-	4800	2000	300	5070	-
Corsoio di montaggio Climbing cage Cage de montage Jaula de montaje		SK1700	1	8300	2600	2500	6000	-
		SN2050	1	8300	2900	2700	6700	-

GRU IN CAVEDIO – TELESCOPAGE SUR DALLES – CLIMBING CRANE – KLETTERKRANE IM GEBAUDE

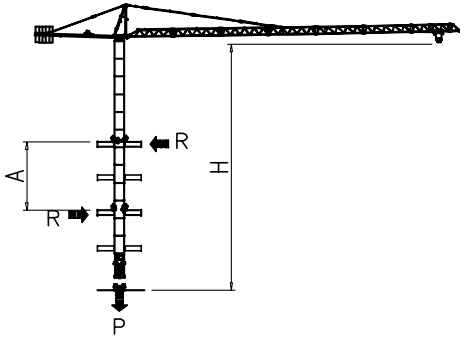

SN2050	H (m)	A (m)	R (t)	P (t)
	9	45.3		
	10	42		
	11	39.3		
	12	37		
	13	35		
	14	33.4		
	15	32		
	16	30.7		
	17	29.6		
	18	28.6		
Apertura passaggio gru Opening for crane passing 	19	27.8		
	20	27		

* SOPRALZO IDRAULICO – TELESCOPABLE – EXTERNAL CLIMBING – KLETTERKRANE

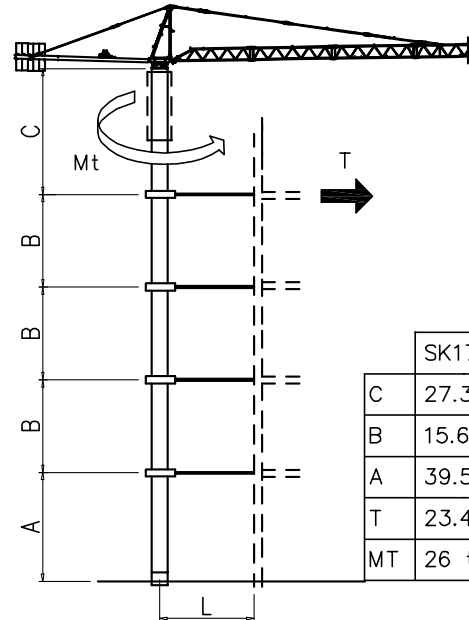
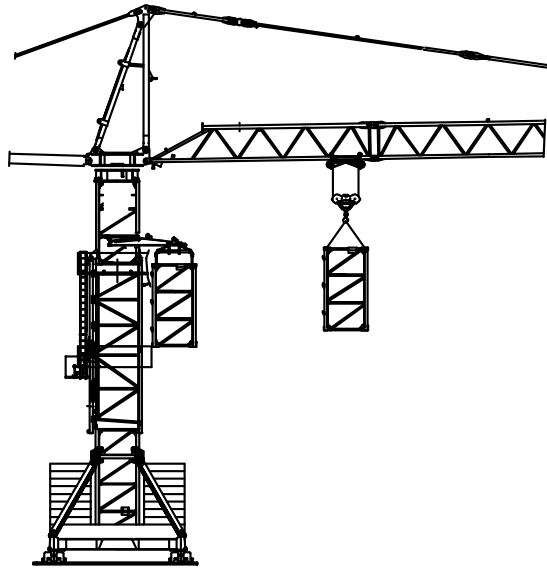

	SK1700	SN2050
C	27.3 m	31.2 m.
B	15.6 m	19.5 m
A	39.5 m	50 m
T	23.4 t	27.5 t
MT	26 t xm	26 t xm

Montaggio – Montage – Erection – Montage – Montaje – Montagem

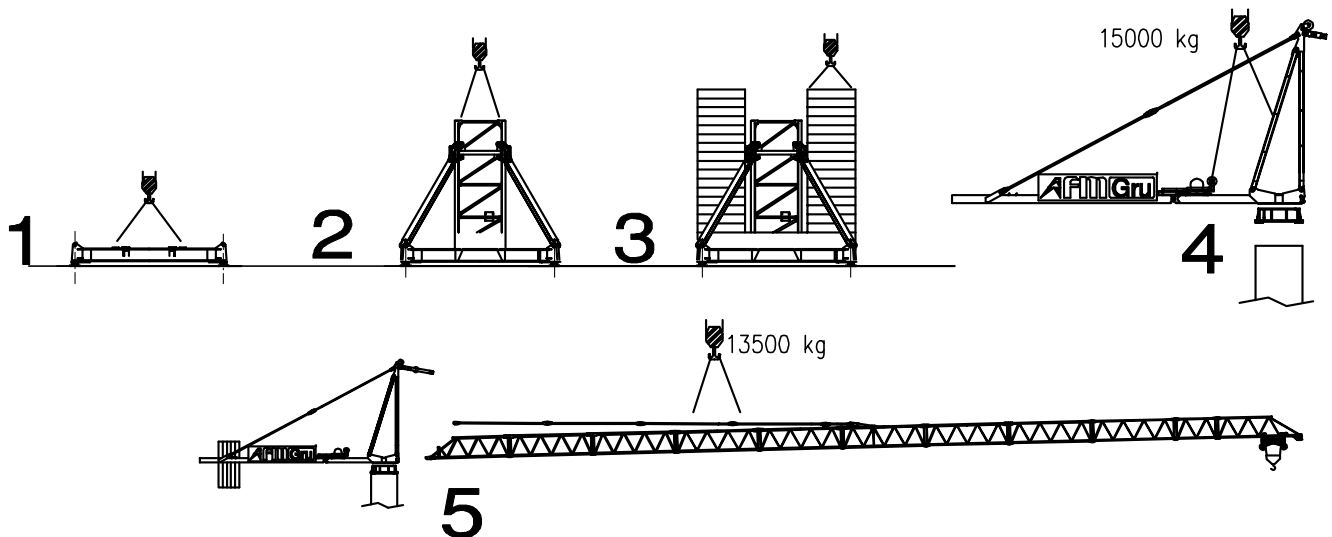

Meccanismi – Mechanisms – Mécanismes – Antriebe – Mecanismos

Sollevamento V45.60 Hoisting Levage Heben Elevaciòn Elevaçao														V45.60 33 kW 57 kVA 270 m 500 m (L)
	m/min	3	14	30	45	60	72	1.5	7	15	22.5	30	36	
	t	6	6	6	3.5	2.4	1.4	12	12	12	7	4.8	2.8	

Sollevamento V100.130 Hoisting Levage Heben Elevaciòn Elevaçao														V100.130 75 kW 110 kVA 360 m 750 m (L)
	m/min	6	28	54	86	115	130	3	14	27	43	57	65	
	t	6	6	6	4	2.8	1.4	12	12	12	8	5.6	2.8	

Carrello Trolleying Distribution Katzfahren Distribuciòn Distribuiçao			0 → 100	m/min	5.5 kW	Potenza elettrica necessaria Puissance électrique nécessaire Necessary electric power Anschlusswert – Potencia
Rotazione Slewing Orientation Schwenken Orientaciòn Rotaçao			0 → 0,9	giri/min tr/min rp/min	6.6 kW @ 1200rpm n° 3 x 2.2 kW	
Traslazione Travelling Translation Kranfahren Traslaciòn Traslaçao			0 → 20	m/min	7.5 kW	

Rete elettrica – Réseau – Mains supply – Netzstrom – Red – Rede electrica	400V – 50 Hz
---	--------------

Rete elettrica – Réseau – Mains supply – Netzstrom – Red – Rede electrica	400V – 50 Hz
---	--------------

AFM Gru FMgru s.r.l.
via Emilia 11-29010 Pontenure PC ITALY
tel. 0523/510446 ric.aut. fax 0523/510365
www.fmgru.it e-mail: info@fmgru.com

FEM 1.001
2000/14/CE



Documento commerciale non contrattuale
Per tutte le informazioni tecniche riferirsi
alle corrispondenti istruzioni

Unverbindliches Vertriebsdokument.
Für technische Informationen, siehe die
entsprechenden Anweisungen.

This commercial document is not legally
binding. For any technical information, please
refer to the corresponding instructions.

Documento comercial no contractual
Para cualquier información técnica,
ver la noticia correspondiente.

Code: 15ICA37K45A1		
Ed.	Data	Rev Data
1	05.06.03	3 22.03.10