

# T 560

**Features:**

- ▶ 60 T Maximum Lifting Capacity
- ▶ 110 ft Maximum Boom Length
- ▶ 170 ft Maximum Tip Height
- ▶ Engine Configurations up to 430 hp
- ▶ Automatic and Manual Transmission Options
- ▶ Air-ride Suspension
- ▶ Travel Speeds up to 65 mph

**WORKS FOR YOU.™**

# CONTENTS

Page:

**Key** ..... 3

## Dimensions

Crane Dimensions ..... 4  
Specifications ..... 5  
Range Diagram ..... 6

## Load Charts

11,500 lb Counterweight ..... 7  
7,000 lb Counterweight ..... 10  
4,000 lb Counterweight ..... 13

## Technical Descriptions

Hydraulics ..... 15  
Upper Operator Cab ..... 15  
Boom Controls ..... 15  
Counterweight ..... 15  
Hoists and Rope ..... 16  
Engine and Transmission ..... 16  
Lower Operator Cab ..... 16  
Chassis and Related Components ..... 17  
Boom and Components ..... 17

**Notes** ..... 18

	Counterweight		Main boom with auxiliary head / rooster sheave
	Lifting capacity on outriggers		Auxiliary hoist
	Radius		Hook and ball
	Main boom		Swing brake
	Maximum axle loads		Heating and air conditioning
	Tires		Crane in standard configuration
	Hook block		Load limiter / safety devices
	Main hoist		Engine
	Travel speed		Electrical system
	Gradeability – road		Transmission
	Swing		Rated weight on hook block
	Boom telescoping		Boom over the rear
	Maximum line pull		Steering
	Rope diameter		Hydraulics
	Rope length		Hook block (capacity-sheaves-rope diameter)



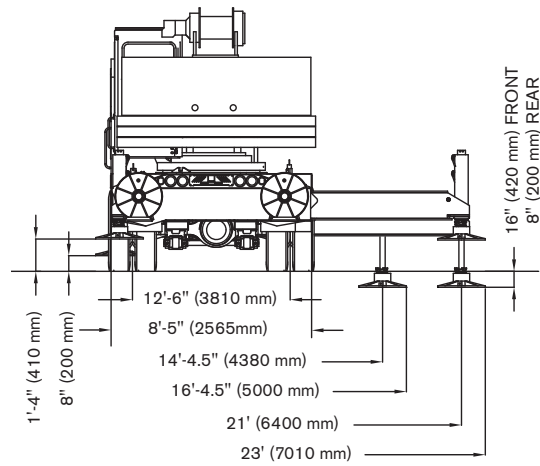
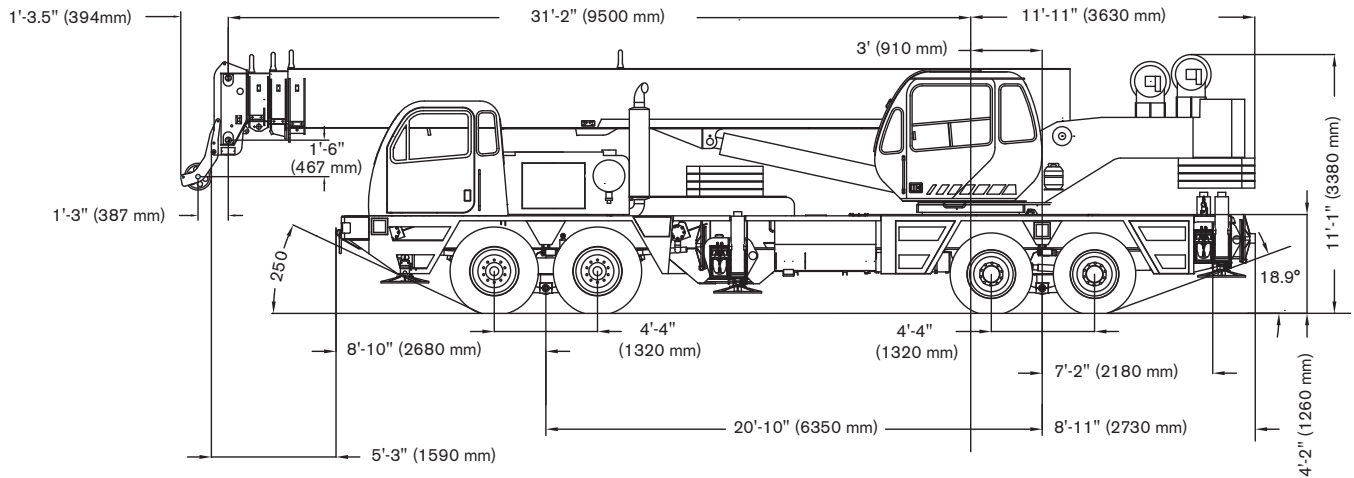



# CRANE DIMENSIONS

















## Weight And Axle Load Chart: Boom In Front Travel Position

Icon	Configuration	Front Axle Load 48,000 Lbs Max	Rear Axle Load 60,000 Lbs Max	Gross Vehicle Weight
	Crane with 1/4 tank fuel 200 lb Operator seated in cab Front Tires: 425/65 R22.5 Rear Tires: 11R22.5 14 Load Range G 20PR 110 ft Boom no jib 4,500 lb rear counterweight	33,512	38,311	71,824

### Counterweight Additions:

	3,000 lb Counterweight on rear	- (1,102)	+ 4,102	+ 3,000
	4,000 lb Counterweight on rear	- (1,470)	+ 5,470	+ 4,000
	5,000 lb Counterweight on rear	- (1,837)	+ 6,387	+ 5,000
	3,000 lb Counterweight on crane deck	+ 1,974	+ 1,026	+ 3,000
	4,000 lb Counterweight on crane deck	+ 2,633	+ 1,367	+ 4,000
	5,000 lb Counterweight on crane deck	+ 3,291	+ 1,709	+ 5,000

### Other Additions:

	Full tank of fuel	+ 244	+ 301	+ 545
	Air conditioning in upper cab	- (8)	+ 158	+ 150
	Heater/defroster in upper cab	+ 4	+ 56	+ 60
	Air conditioning in lower cab	+ 112	- (12)	+ 100
	Auxiliary hoist w/drum roller and 600 ft of 16x9 class wire rope	+ 51	+ 36	+ 87
	Spin resistant wire rope – main hoist	- (19)	+ 109	+ 90
	Spin resistant wire rope – auxiliary hoist	- (27)	+ 117	+ 90
	Electric remote control	+ 100	+ 100	+ 200
	32 ft swing-on jib	+ 1,194	+ 76	+ 1,270
	32 ft to 57 ft extendable swing-on jib	+ 1,922	+ 248	+ 2,170
	Auxiliary boom head	+ 168	- (68)	+ 100
	80 T hook block on bumper 5 sheave, quick reeving	+ 1,839	- (688)	+ 1,157
	40 T hook block on bumper 4 sheave, quick reeving	+ 1,104	- (412)	+ 690
	7 T hook and ball on bumper	+ 383	+ 143	+ 340

# RANGE DIAGRAM

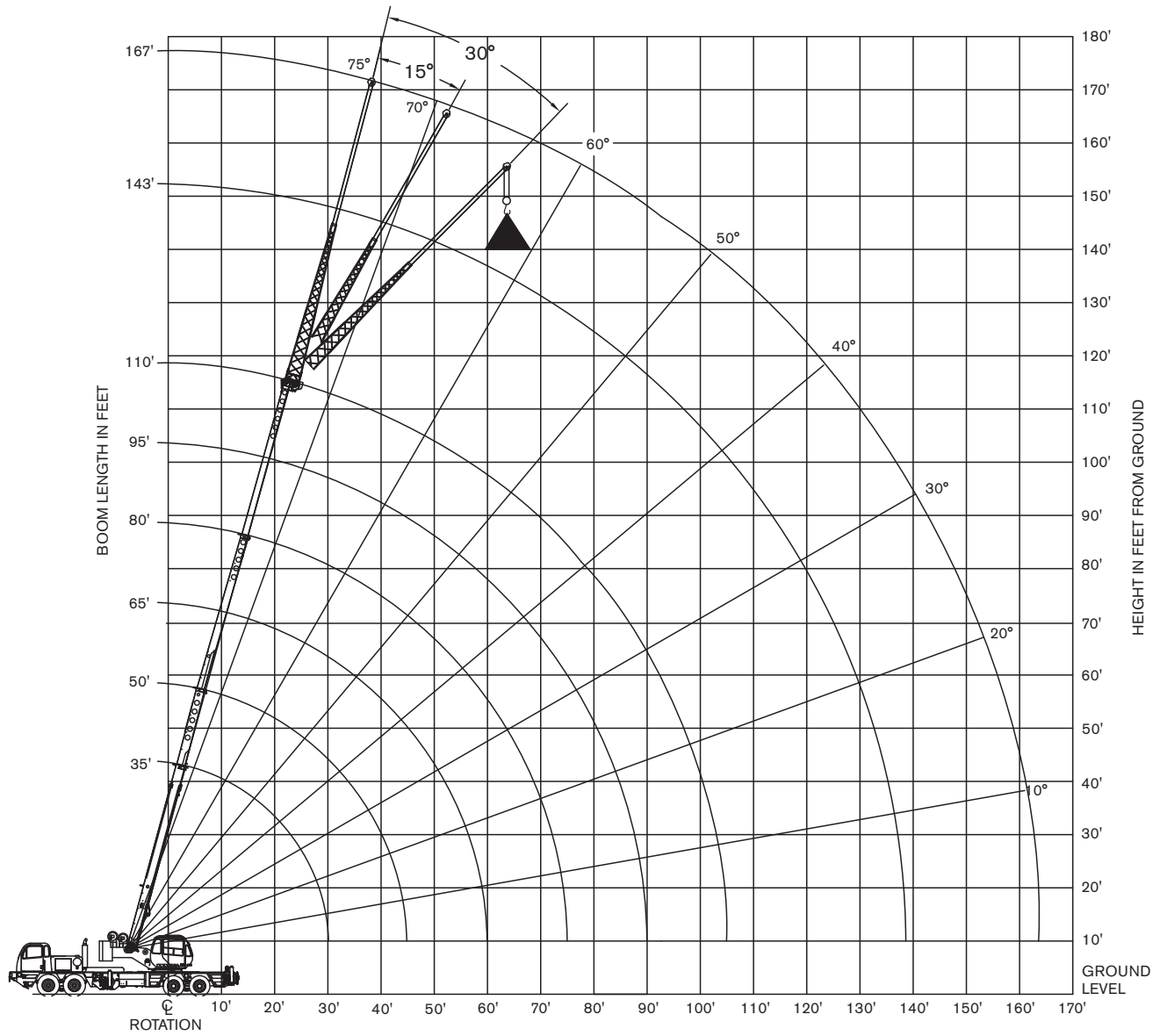

# LOAD CHARTS

**T 560**

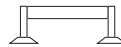

 11,500 lb

 100%

 360°

 35 to 110 ft

ASME Standard  
B 30.5

	Boom Length (ft)						
	35	50	65	80	95	110	
ft	lb	lb	lb	lb	lb	lb	ft
10	120,000	80,000					10
12	98,500	80,000					12
15	80,800	78,400	61,900				15
20	60,400	61,600	54,800	46,200			20
25	46,200	47,600	48,200	40,700	35,300		25
30	32,400	34,200	34,800	35,100	31,100	27,500	30
35		25,600	26,200	26,500	26,700	24,800	35
40		19,800	20,500	20,800	21,000	21,200	40
45		15,600	16,500	16,800	17,000	17,100	45
50		12,700	13,400	13,800	14,000	14,100	50
55			11,000	11,400	11,600	11,800	55
60			9,000	9,500	9,800	9,900	60
65			8,300	7,900	8,200	8,400	65
70				6,600	6,900	7,100	70
75				5,400	5,800	6,000	75
80					4,900	5,100	80
85					4,000	4,300	85
90					3,300	3,500	90
95						2,900	95
100						2,300	100
105						1,800	105

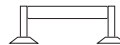

 11,500 lb

 100%

 Over Rear

 35 to 110 ft

ASME Standard  
B 30.5

	Boom Length (ft)						
	35	50	65	80	95	110	
ft	lb	lb	lb	lb	lb	lb	ft
10	120,000	80,000					10
12	106,800	80,000					12
15	83,700	78,400	61,900				15
20	60,400	61,600	54,800	46,200			20
25	46,200	47,600	48,200	40,700	35,300		25
30	36,600	38,100	38,800	36,000	31,100	27,500	30
35		31,400	32,000	32,200	28,000	24,800	35
40		26,200	27,000	27,400	25,200	22,500	40
45		22,200	23,000	23,400	23,100	20,600	45
50			19,200	19,600	19,800	18,800	50
55			16,100	16,600	16,800	16,900	55
60			13,600	14,200	14,400	14,500	60
65				12,200	12,400	12,600	65
70				10,500	10,800	11,000	70
75				9,000	9,400	9,600	75
80					8,200	8,400	80
85					7,100	7,400	85
90					6,200	6,400	90
95						5,600	95
100						4,900	100
105						4,200	105

**Notes to lifting capacity**

Lifting capacities do not exceed 85% of tipping load. Weight of hook blocks and slings is part of the load, and is to be deducted from the capacity ratings. Consult operation manual for further details.

**Note:** Data published herein is intended as a guide only and shall not be construed to warrant applicability for lifting purposes. Crane operation is subject to the computer charts and operation manual both supplied with the crane.

# LOAD CHARTS

 11,500 lb

 100%

 360°

ASME Standard  
B 30.5

## 33 ft Jib with Pullout

0°		15°		30°	
Load Radius ft	360° lbs	Load Radius ft	360° lbs	Load Radius ft	360° lbs
39	12,500	48	8,500	54	6,400
44	11,800	53	8,100	59	6,200
49	11,200	58	7,800	63	6,100
57	10,300	65	7,500	70	5,900
64	9,000	71	7,100	77	5,900
71	7,500	78	6,500	83	5,600
78	6,300	84	5,500	88	5,200
86	4,900	92	4,400	96	4,200
94	3,700	99	3,500	102	3,300
101	2,900	105	2,800	108	2,600
107	2,200	111	2,100	114	2,000
114	1,600	118	1,500	119	1,400
122	900	125	900	125	800
129		131			
135		136			

 11,500 lb

 100%

 360°

ASME Standard  
B 30.5

## 57 ft Jib with Pullout

0°		15°		30°	
Load Radius ft	360° lbs	Load Radius ft	360° lbs	Load Radius ft	360° lbs
47	6,500	64	4,500	73	3,300
54	6,400	69	4,300	78	3,200
60	6,200	75	4,100	83	3,100
69	6,000	83	3,900	90	3,000
78	5,400	90	3,700	97	2,900
86	4,900	97	3,500	103	2,800
94	4,500	104	3,300	109	2,700
104	3,600	113	3,100	117	2,600
113	2,800	120	2,600	124	2,400
121	2,100	128	2,000	130	1,900
128	1,600	134	1,500	136	1,400
136	1,100	141	1,000	142	900
144		148		149	
152		155			
159		160			

### Notes to lifting capacity

Lifting capacities do not exceed 85% of tipping load. Weight of hook blocks and slings is part of the load, and is to be deducted from the capacity ratings. Consult operation manual for further details.

**Note:** Data published herein is intended as a guide only and shall not be construed to warrant applicability for lifting purposes. Crane operation is subject to the computer charts and operation manual both supplied with the crane.



# LOAD CHARTS

**T 560**

 11,500 lb



 Over Rear

ASME Standard  
B 30.5

Boom		Travel Speed		
Radius	Length	0 mph	Creep	2.5 mph
ft	ft	lb	lb	lb
10	35	28,100	17,700	11,600
12	35	25,500	15,800	10,200
15	35	22,300	13,400	8,300
20	50	18,000	10,300	5,800
25	50	14,600	7,900	3,900
30	50	11,900	5,800	2,300
35	50	9,600	4,400	1,200
40	65	7,200	3,500	
45	65	5,700	2,700	
50	65	4,600	2,000	
55	65	3,600	1,400	
60	80	2,800		
65	80	1,500		
70	95	1,200		

**Notes to lifting capacity**

Lifting capacities do not exceed 85% of tipping load. Weight of hook blocks and slings is part of the load, and is to be deducted from the capacity ratings. Consult operation manual for further details.

**Note:** Data published herein is intended as a guide only and shall not be construed to warrant applicability for lifting purposes. Crane operation is subject to the computer charts and operation manual both supplied with the crane.

# LOAD CHARTS

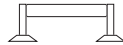

 7,000 lb

 100%

 360°

 35 to 110 ft

ASME Standard  
B 30.5

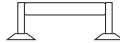

	Boom Length (ft)						
	35	50	65	80	95	110	
ft	lb	lb	lb	lb	lb	lb	ft
10	120,000						10
12	96,800	80,000					12
15	79,100	78,400	61,900				15
20	58,300	59,600	54,800	46,200			20
25	41,300	42,800	43,500	40,700	35,300		25
30	28,100	29,900	30,500	30,800	31,000	27,500	30
35		22,200	22,800	23,100	23,300	23,500	35
40		17,000	17,700	18,000	18,200	18,400	40
45		13,200	14,100	14,400	14,600	14,700	45
50			11,300	11,700	11,900	12,000	50
55			9,100	9,600	9,800	9,900	55
60			7,300	7,900	8,100	8,200	60
65				6,400	6,700	6,800	65
70				5,200	5,500	5,700	70
75				4,200	4,500	4,700	75
80					3,700	3,900	80
85					2,900	3,200	85
90					2,200	2,500	90
95						1,900	95
100						1,400	100
105						900	105

 7,000 lb

 100%

 Over Rear

ASME Standard  
B 30.5

	Boom Length (ft)						
	35	50	65	80	95	110	
ft	lb	lb	lb	lb	lb	lb	ft
10	120,000	80,000					10
12	103,400	80,000					12
15	81,000	78,400	61,900				15
20	58,300	59,600	54,800	46,200			20
25	44,600	45,900	46,600	40,700	35,300		25
30	35,300	36,800	37,400	36,000	31,100	27,500	30
35		30,200	30,900	31,300	28,000	24,800	35
40		24,700	25,400	25,700	25,200	22,500	40
45		19,800	20,700	21,000	21,200	20,600	45
50			17,100	17,500	17,700	17,800	50
55			14,200	14,700	14,900	15,000	55
60			11,900	12,500	12,700	12,800	60
65				10,600	10,900	11,000	65
70				9,100	9,400	9,500	70
75				7,700	8,100	8,300	75
80					7,000	7,200	80
85					6,000	6,200	85
90					5,100	5,400	90
95						4,600	95
100						3,900	100
105						3,300	105

**Notes to lifting capacity**

Lifting capacities do not exceed 85% of tipping load. Weight of hook blocks and slings is part of the load, and is to be deducted from the capacity ratings. Consult operation manual for further details.

**Note:** Data published herein is intended as a guide only and shall not be construed to warrant applicability for lifting purposes. Crane operation is subject to the computer charts and operation manual both supplied with the crane.

# LOAD CHARTS

**T 560**

 7,000 lb

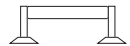
 100%

 360°

ASME Standard  
B 30.5

## 33 ft Jib with Pullout

0°		15°		30°	
Load Radius ft	360° lbs	Load Radius ft	360° lbs	Load Radius ft	360° lbs
39	12,500	48	8,500	54	6,400
44	11,800	53	8,100	59	6,200
50	11,200	58	7,800	64	6,100
57	10,100	65	7,500	70	5,900
65	8,000	72	6,700	76	5,900
72	6,300	78	5,500	83	5,000
78	5,100	84	4,500	88	4,100
86	3,800	92	3,400	95	3,100
94	2,900	99	2,600	102	2,400
101	2,100	106	1,900	108	1,800
107	1,500	111	1,400	114	1,300
114		118		120	
122		125		126	
129		131			
135		136			

 7,000 lb

 100%

 360°

ASME Standard  
B 30.5

## 57 ft Jib with Pullout

0°		15°		30°	
Load Radius ft	360° lbs	Load Radius ft	360° lbs	Load Radius ft	360° lbs
47	6,500	63	4,500	73	3,300
54	6,400	69	4,300	79	3,200
60	6,200	74	4,100	84	3,100
69	6,000	82	3,900	91	3,000
78	5,400	90	3,700	98	2,900
86	4,600	97	3,500	105	2,800
94	3,800	104	3,200	111	2,700
104	2,900	112	2,400	118	2,300
112	2,100	120	1,800	126	1,700
120	1,500	127	1,300	132	1,300
128	900	134	900	137	800
136		141		143	
144		148		149	
152		155			
158		160			

**Notes to lifting capacity**

Lifting capacities do not exceed 85% of tipping load. Weight of hook blocks and slings is part of the load, and is to be deducted from the capacity ratings. Consult operation manual for further details.

**Note:** Data published herein is intended as a guide only and shall not be construed to warrant applicability for lifting purposes. Crane operation is subject to the computer charts and operation manual both supplied with the crane.

# LOAD CHARTS

 7,000 lb



 Over Rear

ASME Standard  
B 30.5

Boom		Travel Speed		
Radius	Length	0 mph	Creep	2.5 mph
ft	ft	lb	lb	lb
10	35	29,100	18,700	12,700
12	35	26,500	16,800	11,100
15	35	23,200	14,300	9,200
20	50	18,700	11,100	6,600
25	50	14,000	8,500	4,600
30	50	10,900	6,400	2,900
35	50	8,400	5,000	1,800
40	65	6,400	4,000	1,100
45	65	4,900	3,100	
50	65	3,800	2,400	
55	65	2,900	1,800	
60	80	2,200	1,200	
65	80	1,600		

### Notes to lifting capacity

Lifting capacities do not exceed 85% of tipping load. Weight of hook blocks and slings is part of the load, and is to be deducted from the capacity ratings. Consult operation manual for further details.

**Note:** Data published herein is intended as a guide only and shall not be construed to warrant applicability for lifting purposes. Crane operation is subject to the computer charts and operation manual both supplied with the crane.

# LOAD CHARTS

**T 560**



4,000 lb

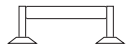

100%



360°



35 to 110 ft

ASME Standard  
B 30.5

ft	Boom Length (ft)						ft
	35	50	65	80	95	110	
lb	lb	lb	lb	lb	lb	lb	lb
10	120,000	80,000					10
12	95,200	80,000					12
15	77,600	78,400	61,900				15
20	56,800	58,100	54,800	46,200			20
25	38,700	40,200	40,900	40,700	35,300		25
30	26,100	27,900	28,500	28,800	29,000	27,500	30
35		20,600	21,200	21,500	21,700	21,800	35
40		15,600	16,300	16,600	16,800	17,000	40
45		12,000	12,900	13,200	13,400	13,500	45
50			10,200	10,600	10,800	10,900	50
55			8,100	8,600	8,800	8,900	55
60			6,400	7,000	7,200	7,300	60
65				5,600	5,900	6,000	65
70				4,400	4,800	4,900	70
75				3,400	3,800	4,000	75
80					3,000	3,200	80
85					2,300	2,500	85
90					1,600	1,900	90
95						1,300	95
100						800	100



4,000 lb

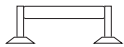

100%



Over Rear



35 to 110 ft

ASME Standard  
B 30.5

ft	Boom Length (ft)						ft
	35	50	65	80	95	110	
lb	lb	lb	lb	lb	lb	lb	lb
10	120,000	80,000					10
12	100,900	80,000					12
15	78,900	78,400	61,900				15
20	56,800	58,100	54,800	46,200			20
25	43,400	44,700	45,300	40,700	35,300		25
30	34,200	35,700	36,400	36,000	31,100	27,500	30
35		29,300	29,900	30,200	28,000	24,800	35
40		22,900	23,700	24,000	24,200	22,500	40
45		18,300	19,200	19,500	19,700	19,800	45
50			15,800	16,200	16,400	16,500	50
55			13,100	13,600	13,800	13,900	55
60			10,900	11,500	11,700	11,800	60
65				9,700	10,000	10,100	65
70				8,200	8,600	8,700	70
75				6,900	7,300	7,500	75
80					6,300	6,500	80
85					5,300	5,600	85
90					4,500	4,800	90
95						4,000	95
100						3,400	100
105						2,800	105

**Notes to lifting capacity**

Lifting capacities do not exceed 85% of tipping load. Weight of hook blocks and slings is part of the load, and is to be deducted from the capacity ratings. Consult operation manual for further details.

**Note:** Data published herein is intended as a guide only and shall not be construed to warrant applicability for lifting purposes. Crane operation is subject to the computer charts and operation manual both supplied with the crane.

# LOAD CHARTS

 4,000 lb



 Over Rear

ASME Standard  
B 30.5

Boom		Travel Speed		
Radius	Length	0 mph	Creep	2.5 mph
ft	ft	lb	lb	lb
10	35	29,900	19,500	13,500
12	35	27,200	17,500	11,900
15	35	23,800	15,000	9,900
20	50	19,300	11,700	7,200
25	50	13,500	9,100	5,100
30	50	9,600	6,900	3,400
35	50	7,200	5,400	2,200
40	65	5,400	4,400	1,400
45	65	4,100	3,500	
50	65	3,000	2,700	
55	65	2,300	2,100	

**Notes to lifting capacity**





Lifting capacities do not exceed 85% of tipping load. Weight of hook blocks and slings is part of the load, and is to be deducted from the capacity ratings. Consult operation manual for further details.

**Note:** Data published herein is intended as a guide only and shall not be construed to warrant applicability for lifting purposes. Crane operation is subject to the computer charts and operation manual both supplied with the crane.



## Hydraulics

<p>Three pump system                  Main boom hoist and telescope tandem pump                  Outrigger and swing                  Power steering                  Simultaneous operation of hydraulic functions                  Two-speed boom extension</p>	<p>60.3 /45.1 gal/min @ 3,500 psi                  22 gal/min 2,500 psi                  8 gal/min @ 1,500 psi</p>
<p>Full flow with bypass protection                  Suction                  Return</p>	<p>250 micron screen                  5 micron filter</p>
<p>Pressurized tank with sight level gauge</p>	<p>117 gal</p>

## Upper Operator Cab

	<p>Upper cab                  Sliding door on left side                  Sliding window on the right side                  Tilting, tinted glass skylight                  Removable front windshield                  Six-way adjustable seat with armrest dual-axis electro-proportional joysticks                  Joystick control for hoist(s), swing and boom elevation                  Foot pedals for swing brake, boom telescope and engine rpm                  Hand control for engine rpm</p>
 	<p>Optional features for upper cab                  Air conditioning – hydraulically powered                  Heater and air conditioning package – hydraulically powered                  Liquid propane (LP) cab heater                  Single-axis armrest mounted controls                  Work lights                  Upper cab remote carrier control                  AM/FM radio with cassette</p>
	<p>Rated capacity indicator with pictograph display of boom radius, boom angle, boom length, allowable load, actual load and % of allowable load                  Settable alarms for swing angle, boom length, boom angle, tip height and work area exclusion zone</p>

## Boom Controls

	<p>Foot pedal actuated multi-disc brake and air actuated 360° house lock</p>
	<p>Hydraulic driven double planetary reduction gear drive <span style="float: right;">2.8 rev/min</span></p>

## Counterweight



	<p>Main counterweight with integrated hydraulic removal system is bolted to upper crane structure                  Hydraulic system allows weights to be removed and attached without additional lifting equipment for placement on carrier deck</p>	<p>11,500 lb counterweight package</p>
---	--	--

# TECHNICAL DESCRIPTIONS

## Hoists and Rope

	Two speeds First layer (no load speed) Fifth layer (no load speed)	Low Speed: 184 ft/min 266 ft/min	High Speed: 369 ft/min 533 ft/min
	First layer Fifth layer	Low Speed: 15,639 lb 10,827 lb	High Speed: 10,827 lb 5,052 lb
	Permissible line pull		9,000 lb
			6x19 IWRC IPS
	Maximum useable		561 ft
	Rope diameter		0.625 in
	Two speeds Fifth layer (no load speed)		High Speed: 533 ft/min
	First layer		Low Speed: 15,639 lb
	Permissible line pull		9,000 lb
	Optional		0.625 in rotation resistant, compacted strand 18x19
	Optional		0.625 in

## Engine and Transmission





	<b>Standard Engine and Transmission</b>		
	Detroit Diesel 60 Series turbocharged and aftercooled Eaton Fuller		12.7 l / 430 hp 10 speed manual
	<b>Optional Engine and Transmission</b>		
	Detroit Diesel 60 Series turbocharged and aftercooled Allision automatic		12.7 l / 430 hp 7 speed with lock-up torque converter
	Fuel capacity		100 gal
	Voltage Batteries Alternator		12 VDC Three 950 CCA 130 amp

## Lower Operator Cab









	<b>Lower Cab</b>		
	Hinged door on left side with roll-down window		
	Sliding window on the right side		
	Six-way adjustable seat with seatbelt		
	Cruise control		
	Two speed windshield wiper with washer Jacobs engine brake		



## Chassis and Related Components

	Turn radius	42 ft 8 in turn radius to CL of tires
	Front axle – maximum capacity Tubular beam with equalizer air suspension mounting	45,600 lb
	Rear axle – maximum capacity Interaxle differential with lock-out Equalizer beam air suspension mounting	43,000 lb
	Aluminium wheels with stainless hub covers	
	Front	425/65R22.5-18 PR
	Rear	11 R22.5-14 PR
	Theoretical maximum	
	Manual transmission	100 +%
	Automatic transmission	100 +%
	Manual transmission	65 mph
	Automatic transmission	65 mph
	Axle drive system	8x4 drive
	Air brakes with ABS	Air release / spring set

## Boom and Components

	Full power extension via foot pedal control	Four Section
	Retracted boom length	35 ft
	Extended boom length	110 ft
	Maximum tip height	114 ft
	Raised – maximum	+76°
	Lower – minimum	-4°
	<b>Optional</b>	
	Swing-On Jib – Fixed length – can be offset to 0°, 15°, or 30°	33 ft
	Maximum tip height with fixed jib	145 ft
	Swing-On Jib – adjustable length – can be offset to 0°, 15°, or 30°	33 ft to 57 ft
	Maximum tip height with extended jib	169 ft
	Idler sheaves Quick reeving design	
	Installs only on main boom head Compatible with extendable and fixed swing-on jibs	Single nylon sheave
	5 metallic sheaves Quick reeving design	60 T
	Optional 5 metallic design	40 T
	Top swivel ball with hook and latch	7 T





[www.terexcranes.com](http://www.terexcranes.com)

Effective Date: October 2010. Product specifications and prices are subject to change without notice or obligation. The photographs and/or drawings in this document are for illustrative purposes only. Refer to the appropriate Operator's Manual for instructions on the proper use of this equipment. Failure to follow the appropriate Operator's Manual when using our equipment or to otherwise act irresponsibly may result in serious injury or death. The only warranty applicable to our equipment is the standard written warranty applicable to the particular product and sale and Terex makes no other warranty, express or implied. Products and services listed may be trademarks, service marks or trade-names of Terex Corporation and/or its subsidiaries in the USA and other countries. All rights are reserved. Terex® is a registered trademark of Terex Corporation in the USA and many other countries. © 2010 Terex Corporation.

Terex Cranes, Global Marketing, Dinglerstraße 24, 66482 Zweibrücken, Germany  
Tel. + 49 (0) 6332 830, Email: [info.cranes@terex.com](mailto:info.cranes@terex.com), [www.terexcranes.com](http://www.terexcranes.com)

TC-DS-I-E-T560 10/10



**WORKS FOR YOU.™**