

AC 130-5



All Terrain Crane

140UST CAPACITY CLASS

	Page:
Dimensions.....	4
Specifications.....	6
Equipment.....	7
Counterweight.....	8

















	<p>HA Main boom</p>	9
---	--------------------------------------	---















	<p>HAV Folding swing-away jib</p>	20
---	--	----

	<p>HAV-VA Variable extension with swing-away jib</p>	24
---	---	----

	<p>MS Runner</p>	28
---	-----------------------------------	----

Technical description.....	34
----------------------------	----

	Counterweight
	Lifting capacities on outriggers - 360°
	Radius
	Main boom
	Folding swing-away jib
	Runner
	Max. axle loads
	Mechanism
	Tires
	Hook block
	Hoist
	Dolly
	Travel speed
	Gradeability – road
	Gradeability – off road
	Slewing

	Boom telescoping
	Boom elevation
	Working speeds
	Max. line pull
	Rope diameter
	Rope length
	Hook block (capacity-sheaves-rope diameter)
	Number of lines
	Possible load of hook block
	Weight of hook block
	Distance head sheave axle – hook ground
	Number of sheaves in boom head
	Supporting force
	Length of stroke (support cylinders)
	Payload incl. rear storage box

DIMENSIONS

AC 130-5

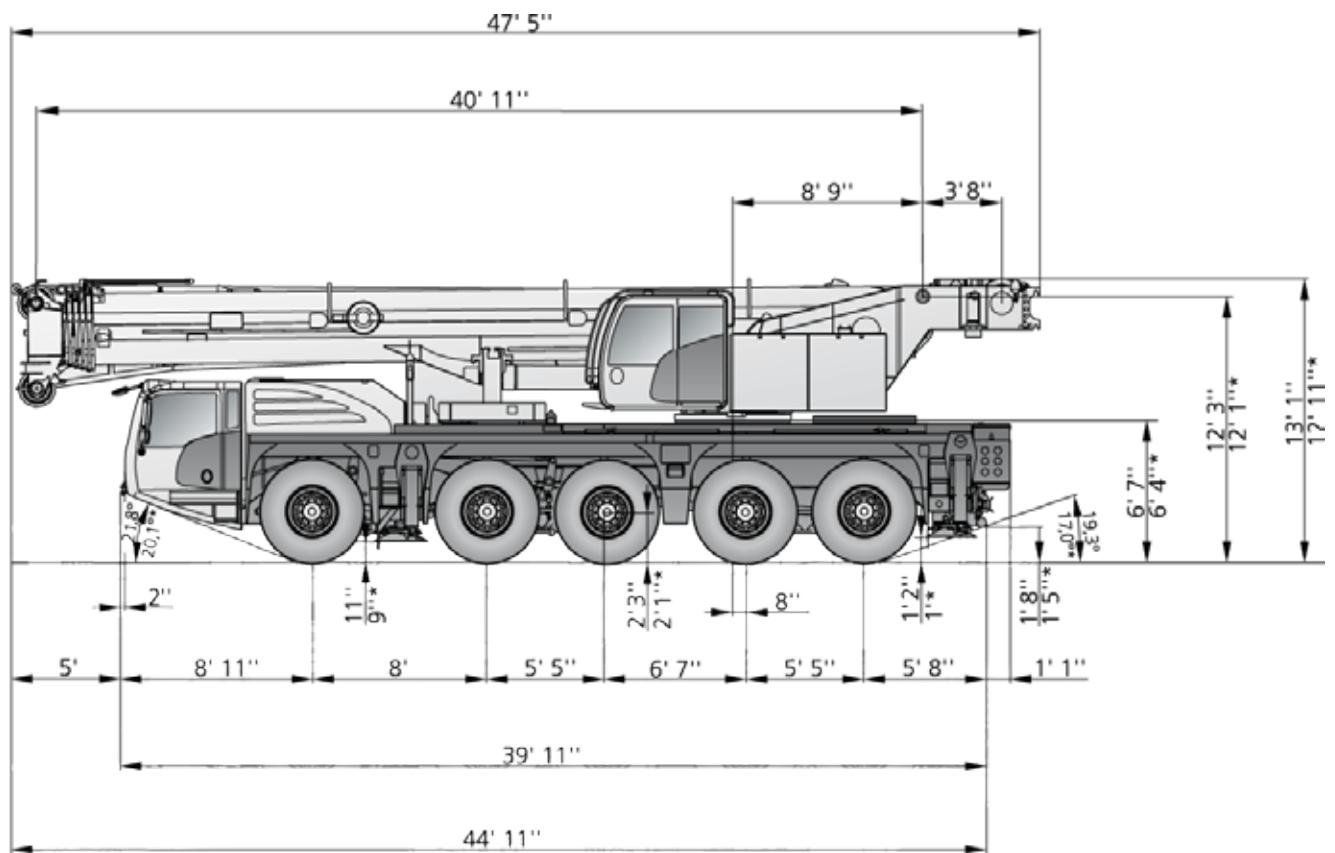

⊙ 445/95 R25 / 525/80 R25

* ⊙ 385/95 R25

DIMENSIONS

AC 130-5

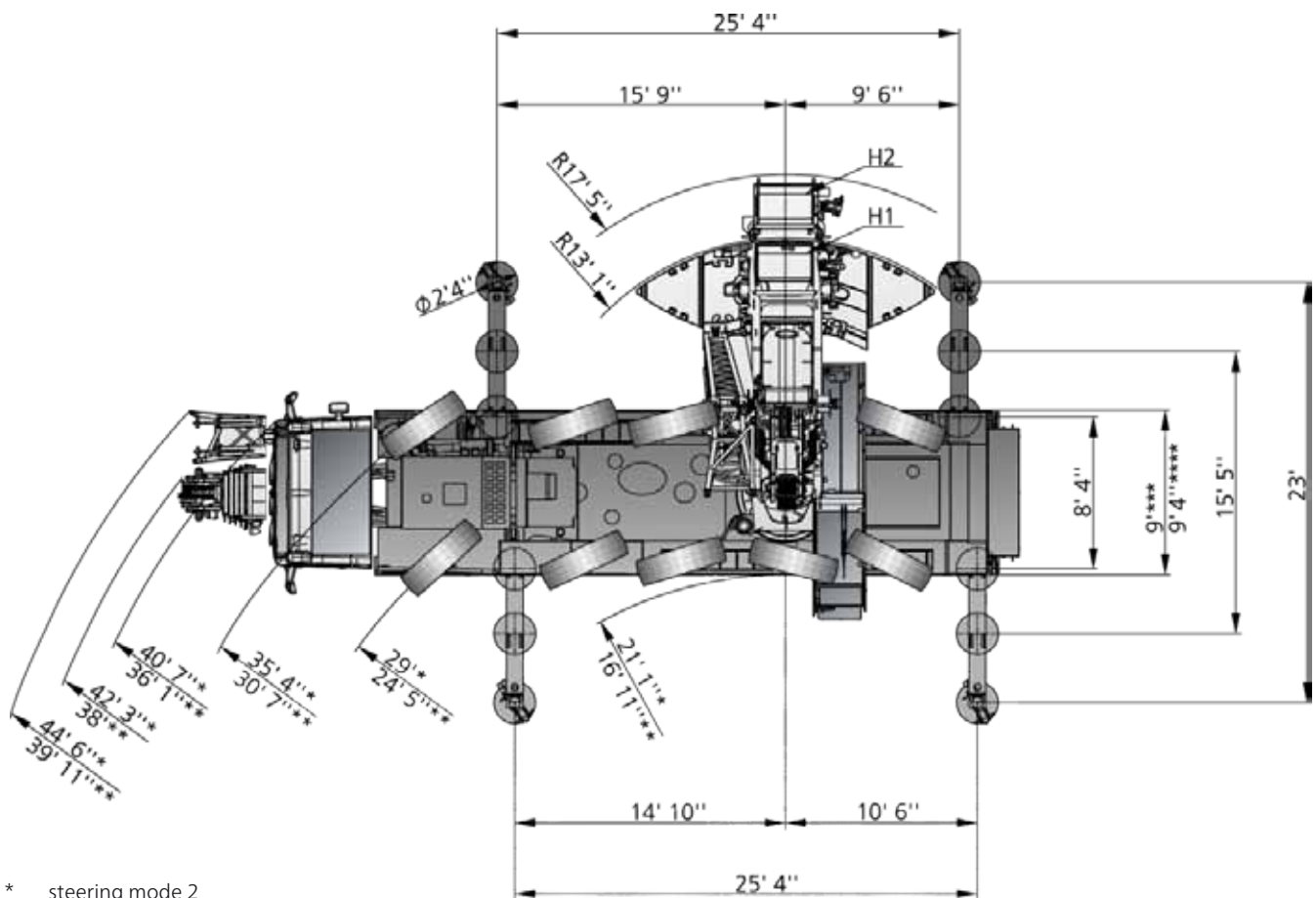

* steering mode 2

** steering mode 3











***  385/95 R25 / 445/95 R25

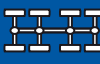





****  525/80 R25

see page 6



SPECIFICATIONS

AC 130-5



										
	Total									
< 20,000 lb				On request!						X
17,000 lb	79,400 lb	10 x 6 x 10	385/95R25	–	–	8,200 lb	–	–	–	
22,000 lb	105,800 lb	10 x 6 x 10	445/95R25	196.9 ft	–	–	–	1,100 lb	–	
26,500 lb	132,300 lb	10 x 8 x 10	445/95R25	196.9 ft	12-0-21	23,600 lb	–	880 lb	–	
26,500 lb	132,300 lb	10 x 8 x 10	445/95R25	196.9 ft	12-0-21	19,000 lb	68.9 ft	1,100 lb	–	
35,300 lb	174,200 lb	10 x 8 x 10	445/95R25	196.9 ft	80-3-21	57,800 lb	68.9 ft	1,980 lb	–	









	1 Highway > 28 mph		4* Off-wall
	2 City < 28 mph		5* Crab steer mode
	3* Minimum turning radius < 3.1 mph		6* All wheel steering

*must be activated

		
139,000 lb	161,000 lb	52.8 mph ¹⁾
20.9 in	24 in	

¹⁾ Depending on tire type, size and country specific legislation

	385 / 95 R 25 14.00 R 25	445 / 95 R 25 16.00 R 25	525 / 80 R 25 20.50 R 25
	47 %	40 %	40 %
	64 %	53 %	53 %

				
1	394 ft/min	18,525 kN	0.83 in	984 ft
2	394 ft/min	18,525 kN	0.83 in	1083 ft
	1,70 min ⁻¹			
	ca. 438 s (41.0 - 196.2 ft)			
	ca. 35 s (-1,5° - 82°)			

					
1	18,300	12-0-21	4	770 lb	6.6 ft
2	36,600	32-1-21	4	1320 lb	8.9 ft
3	54,900	32-1-21	4	1320 lb	8.9 ft
4	72,300	80-3-21	4	1870 lb	9.8 ft
5	90,000	80-3-21	4	1870 lb	9.8 ft
6	107,400	80-3-21	4	1870 lb	9.8 ft
7	124,600	80-3-21	4	1870 lb	9.8 ft
8	141,800	125-5-21	4	2480 lb	9.8 ft
9	158,800	125-5-21	4 + S1	2480 lb	9.8 ft
10	175,500	125-5-21	4 + S1	2480 lb	9.8 ft
11	192,000	160-7-21	4 + S1	3310 lb	9.8 ft
12	202,400	160-7-21	4 + S1	3310 lb	9.8 ft

HAV / HAV-VA

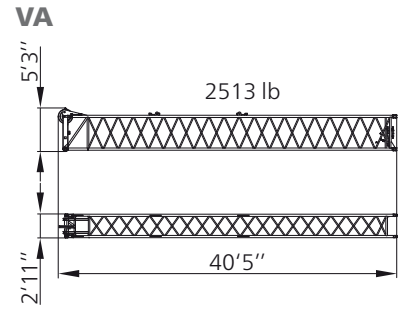
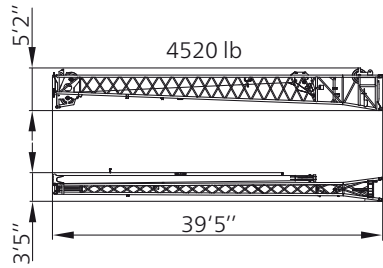

HAV-VA 108.3 ft

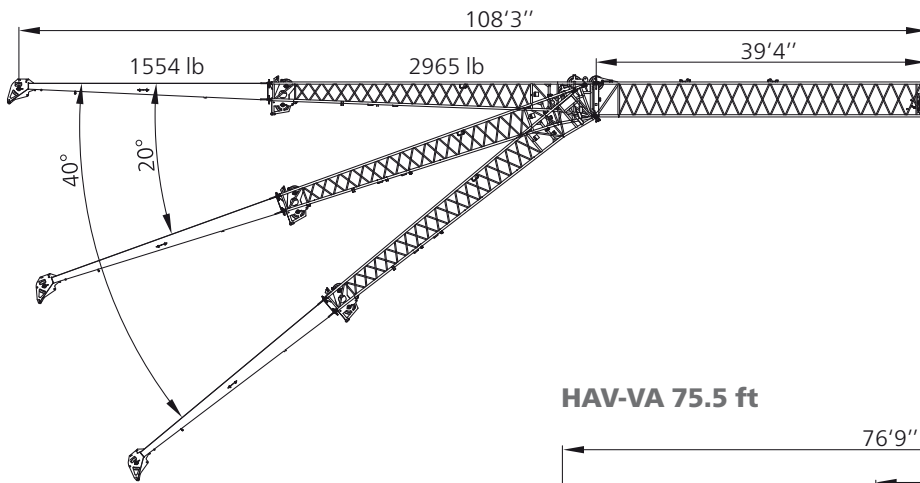

HAV-VA 75.5 ft

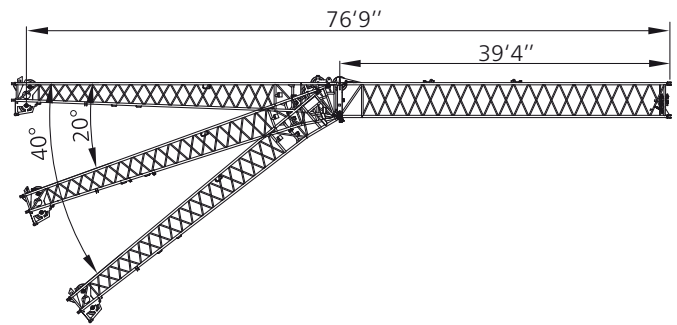

HAV 68.9 ft

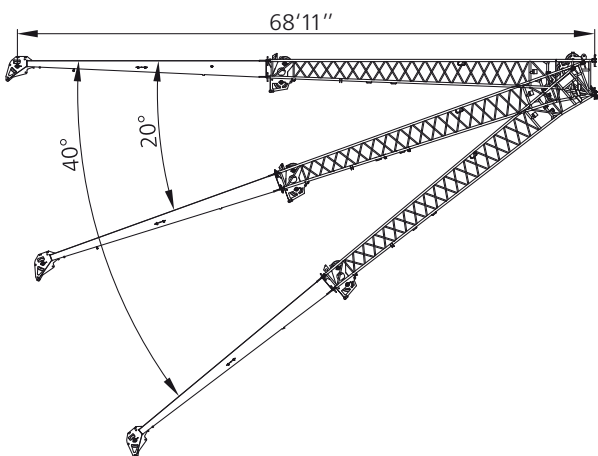

HAV 36.1 ft

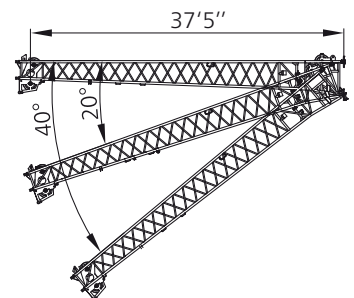

Parts

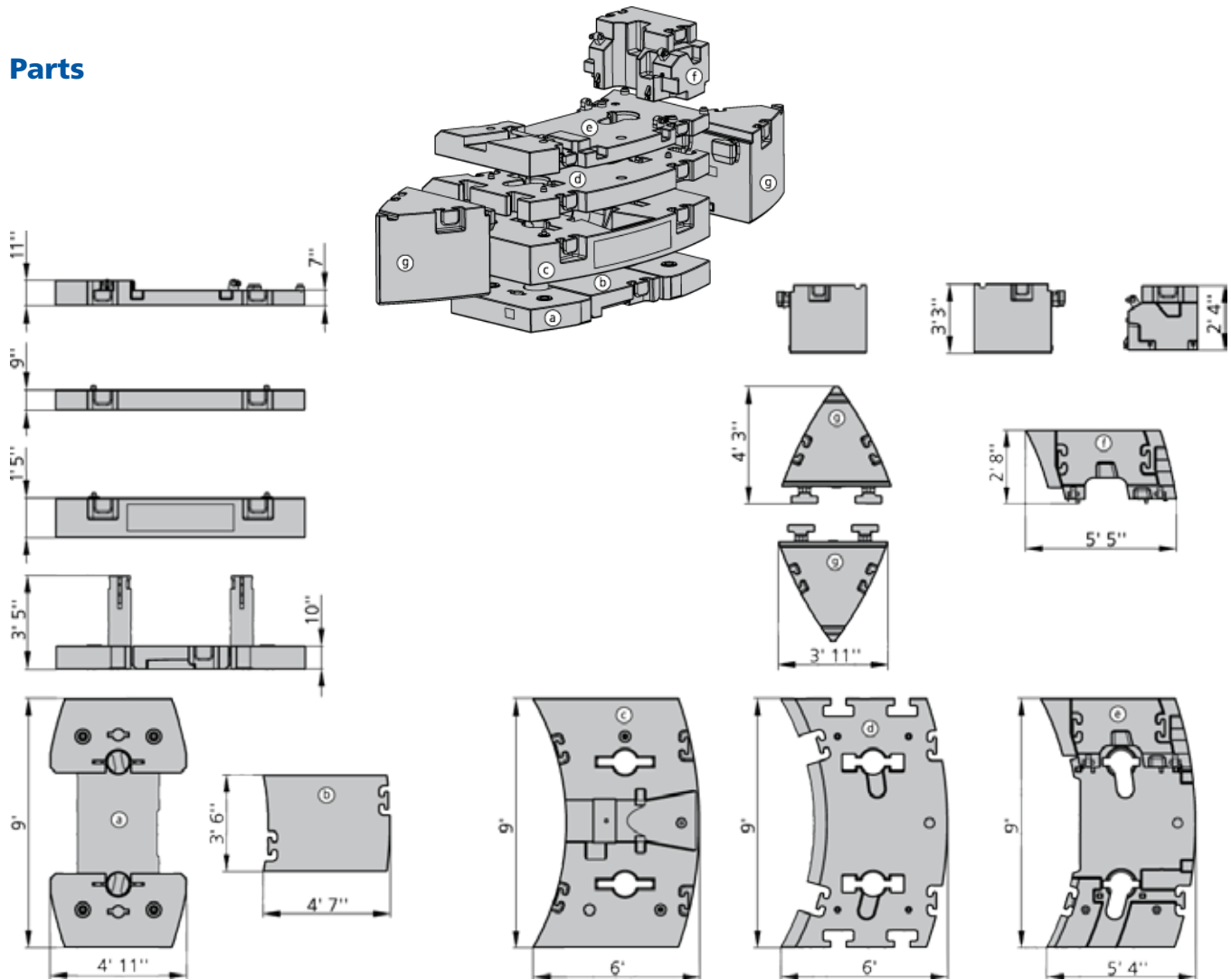

Configurations

	Ⓐ 10,800 lb	Ⓑ 4,630 lb	Ⓒ 24,260 lb	Ⓓ 11,910 lb	Ⓔ 9,920 lb	Ⓕ 8,200 lb	Ⓖ 11,690 lb	Ⓗ 11,690 lb
0 lb								
8,200 lb						X		
10,800 lb	X							
15,400 lb	X	X						
18,100 lb					X	X		
19,000 lb	X					X		
23,600 lb	X	X				X		
28,900 lb	X				X	X		
33,500 lb	X	X			X	X		
39,700 lb	X	X	X					
47,800 lb	X	X	X			X		
51,600 lb	X	X	X	X				
57,800 lb	X	X	X		X	X		
59,800 lb	X	X	X	X		X		
61,500 lb	X	X	X	X	X			
69,700 lb	X	X	X	X	X	X		
84,900 lb	X	X	X	X	X		X	X
93,000 lb	X	X	X	X	X	X	X	X

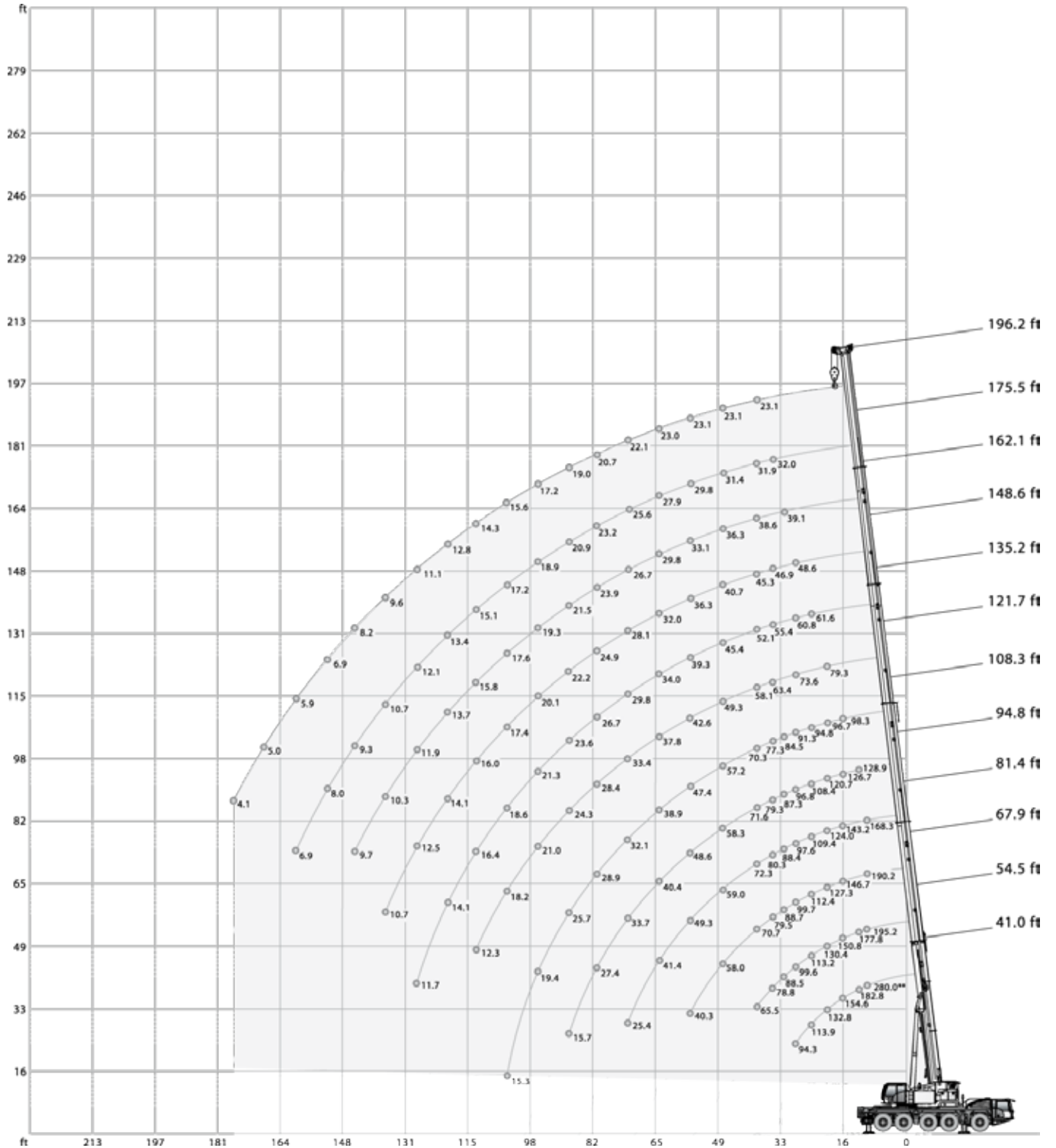
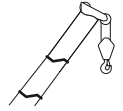

** Capacity class

93,000 lb		25.3 ft x 23.0 ft												360°		85%	
ft	41.0 ft*	41.0 ft	54.5 ft	67.9 ft	81.4 ft	94.8 ft	108.3 ft	121.7 ft	135.2 ft	148.6 ft	162.1 ft	175.5 ft	196.2 ft	ft			
1,000 lb																	
10	280.0**	-	-	-	-	-	-	-	-	-	-	-	-	-	-	10	
10	200.7	200.7	195.2	190.2	168.3	-	-	-	-	-	-	-	-	-	-	10	
12	182.8	182.6	177.8	173.5	164.9	128.9	-	-	-	-	-	-	-	-	-	12	
14	167.6	166.5	163.2	159.0	155.4	128.0	-	-	-	-	-	-	-	-	-	14	
16	154.6	151.9	150.8	146.7	143.2	126.7	98.3	-	-	-	-	-	-	-	-	16	
18	143.4	140.0	140.3	136.7	133.3	124.2	97.5	-	-	-	-	-	-	-	-	18	
20	132.8	129.1	130.4	127.3	124.0	120.7	96.7	79.3	-	-	-	-	-	-	-	20	
24	113.9	111.7	113.2	112.4	109.4	108.4	94.8	77.7	61.6	-	-	-	-	-	-	24	
28	94.3	94.2	99.6	99.7	97.6	96.8	91.3	73.6	60.8	48.6	-	-	-	-	-	28	
32	-	-	88.5	88.7	88.4	87.3	84.5	68.7	58.6	48.2	39.1	-	-	-	-	32	
36	-	-	78.8	79.5	80.3	79.3	77.3	63.4	55.4	46.9	38.9	32.0	-	-	-	36	
40	-	-	65.5	70.7	72.3	71.6	70.3	58.1	52.1	45.3	38.6	31.9	23.1	-	-	40	
48	-	-	-	58.0	59.0	58.3	57.2	49.3	45.4	40.7	36.3	31.4	23.1	23.1	-	48	
56	-	-	-	40.3	49.3	48.6	47.4	42.6	39.3	36.3	33.1	29.8	23.1	23.1	-	56	
64	-	-	-	-	41.4	40.4	38.9	37.8	34.0	32.0	29.8	27.9	23.0	23.0	-	64	
72	-	-	-	-	25.4	33.7	32.1	33.4	29.8	28.1	26.7	25.6	22.1	22.1	-	72	
80	-	-	-	-	-	27.4	28.9	28.4	26.7	24.9	23.9	23.2	20.7	20.7	-	80	
88	-	-	-	-	-	15.7	25.7	24.3	23.6	22.2	21.5	20.9	19.0	19.0	-	88	
96	-	-	-	-	-	-	19.4	21.0	21.3	20.1	19.3	18.9	17.2	17.2	-	96	
104	-	-	-	-	-	-	15.3	18.2	18.6	17.4	17.6	17.2	15.6	15.6	-	104	
112	-	-	-	-	-	-	-	12.3	16.4	16.0	15.8	15.1	14.3	14.3	-	112	
120	-	-	-	-	-	-	-	-	14.1	14.1	13.7	13.4	12.8	12.8	-	120	
128	-	-	-	-	-	-	-	-	11.7	12.5	11.9	12.1	11.1	11.1	-	128	
136	-	-	-	-	-	-	-	-	-	10.7	10.3	10.7	9.6	9.6	-	136	
144	-	-	-	-	-	-	-	-	-	-	9.7	9.3	8.2	8.2	-	144	
152	-	-	-	-	-	-	-	-	-	-	-	8.0	6.9	6.9	-	152	
160	-	-	-	-	-	-	-	-	-	-	-	6.9	5.9	5.9	-	160	
168	-	-	-	-	-	-	-	-	-	-	-	-	5.0	5.0	-	168	
176	-	-	-	-	-	-	-	-	-	-	-	-	4.1	4.1	-	176	
1)	34.6	34.6	25.1	19.4	15.0	11.9	9.0	7.1	4.9	2.9	-	-	-	-	-	1)	

1) Capacities with horizontal boom

* over rear

** Capacity class

		69,700 lb		25.3 ft x 23.0 ft		360° / Max.*								85%		
		360°	Max.	360°	Max.	360°	Max.	360°	Max.	360°	Max.	360°	Max.			
		41.0 ft	41.0 ft	54.5 ft	54.5 ft	67.9 ft	67.9 ft	81.4 ft	81.4 ft	94.8 ft	94.8 ft	108.3 ft	108.3 ft			
		1,000 lb														
ft																ft
10		200.7	200.7	195.2	195.2	190.2	190.2	168.3	168.3	-	-	-	-	-	10	
12		181.8	182.6	177.8	177.9	173.5	173.5	164.9	164.9	128.9	128.9	-	-	-	12	
14		164.7	166.5	163.2	163.2	159.0	159.0	155.4	155.4	128.0	128.0	-	-	-	14	
16		150.3	151.9	150.8	150.8	146.7	146.7	143.2	143.2	126.7	126.7	98.3	98.3	-	16	
18		138.5	140.0	139.7	140.3	136.7	136.7	133.3	133.3	124.2	124.2	97.5	97.5	-	18	
20		127.6	129.1	129.1	130.4	127.3	127.3	124.0	124.0	120.7	120.7	96.7	96.7	-	20	
24		110.4	111.7	112.0	113.2	112.1	112.3	109.4	109.4	108.4	108.4	94.8	94.8	-	24	
28		93.7	94.2	97.6	99.6	97.8	99.6	96.8	97.6	96.8	96.8	91.3	91.3	-	28	
32		-	-	84.7	87.9	84.9	88.0	86.3	88.4	85.7	87.3	84.0	84.5	-	32	
36		-	-	74.7	77.5	75.1	77.6	76.6	78.9	75.9	77.9	74.8	75.9	-	36	
40		-	-	61.3	63.2	67.0	67.9	67.6	69.4	66.9	68.7	65.7	67.4	-	40	
48		-	-	-	-	52.9	56.4	52.7	56.2	51.6	55.3	50.0	54.0	-	48	
56		-	-	-	-	36.8	39.1	41.3	46.0	40.3	45.1	38.8	43.7	-	56	
64		-	-	-	-	-	-	33.4	37.7	32.5	36.8	33.5	35.5	-	64	
72		-	-	-	-	-	-	25.4	25.4	28.5	30.6	27.9	31.6	-	72	
80		-	-	-	-	-	-	-	-	24.3	25.6	23.5	27.1	-	80	
88		-	-	-	-	-	-	-	-	15.7	15.7	20.2	23.4	-	88	
96		-	-	-	-	-	-	-	-	-	-	17.7	18.6	-	96	
104		-	-	-	-	-	-	-	-	-	-	15.3	15.3	-	104	
1)		34.6	34.6	25.1	25.1	19.4	19.4	15.0	15.0	11.9	11.9	9.0	9.0	1)		

		360°	Max.	360°	Max.	360°	Max.	360°	Max.	360°	Max.	360°	Max.			
		121.7 ft	121.7 ft	135.2 ft	135.2 ft	148.6 ft	148.6 ft	162.1 ft	162.1 ft	175.5 ft	175.5 ft	196.2 ft	196.2 ft			
		1,000 lb														
ft																ft
20		79.3	79.3	-	-	-	-	-	-	-	-	-	-	-	20	
24		77.7	77.7	61.6	61.6	-	-	-	-	-	-	-	-	-	24	
28		73.6	73.6	60.8	60.8	48.6	48.6	-	-	-	-	-	-	-	28	
32		68.7	68.7	58.6	58.6	48.2	48.2	39.1	39.1	-	-	-	-	-	32	
36		63.4	63.4	55.4	55.4	46.9	46.9	38.9	38.9	32.0	32.0	-	-	-	36	
40		58.1	58.1	52.1	52.1	45.3	45.3	38.6	38.6	31.9	31.9	23.1	23.1	-	40	
48		48.4	49.3	45.3	45.4	40.7	40.7	36.3	36.3	31.4	31.4	23.1	23.1	-	48	
56		40.0	42.2	37.5	39.3	36.1	36.3	33.1	33.1	29.8	29.8	23.1	23.1	-	56	
64		32.3	36.5	31.0	33.9	30.5	32.0	29.8	29.8	27.9	27.9	23.0	23.0	-	64	
72		26.4	30.6	27.0	29.2	25.7	28.1	25.9	26.7	25.6	25.6	22.1	22.1	-	72	
80		23.3	25.8	22.8	25.5	22.2	24.4	22.2	23.8	21.7	23.2	20.6	20.7	-	80	
88		20.4	22.1	19.2	22.5	19.5	21.4	18.8	21.2	18.8	20.9	18.1	19.0	-	88	
96		17.6	19.7	17.2	19.6	16.9	18.8	16.1	19.0	16.1	18.5	15.1	17.2	-	96	
104		15.3	18.1	15.1	17.1	14.6	17.0	14.5	16.6	13.5	16.0	12.6	15.6	-	104	
112		12.3	12.3	13.3	14.9	12.5	14.9	12.5	14.2	11.6	14.4	10.5	13.6	-	112	
120		-	-	11.5	13.3	10.6	13.4	10.6	12.4	9.8	12.6	8.7	11.7	-	120	
128		-	-	10.0	11.7	9.1	11.9	9.1	11.2	8.3	11.0	7.2	10.1	-	128	
136		-	-	-	-	8.0	10.1	8.0	10.3	6.9	9.6	6.0	8.7	-	136	
144		-	-	-	-	-	-	6.9	9.3	5.8	8.4	4.7	7.5	-	144	
152		-	-	-	-	-	-	-	-	4.7	7.4	3.8	6.3	-	152	
160		-	-	-	-	-	-	-	-	3.9	6.4	2.8	5.4	-	160	
168		-	-	-	-	-	-	-	-	-	-	-	4.5	-	168	
176		-	-	-	-	-	-	-	-	-	-	-	3.8	-	176	
1)		7.1	7.1	4.9	4.9	2.9	2.9	-	-	-	-	-	-	1)		

1) Capacities with horizontal boom

* Max. values are valid only for specific superstructure positions

		57,800 lb		25.3 ft x 23.0 ft		360° / Max.*								85%	
	360°	Max.	360°	Max.	360°	Max.	360°	Max.	360°	Max.	360°	Max.	360°	Max.	
ft	41.0 ft	41.0 ft	54.5 ft	54.5 ft	67.9 ft	67.9 ft	81.4 ft	81.4 ft	94.8 ft	94.8 ft	108.3 ft	108.3 ft	108.3 ft	108.3 ft	
1,000 lb															
10	200.6	200.7	195.2	195.2	190.2	190.2	168.3	168.3	-	-	-	-	-	10	
12	180.7	182.6	177.8	177.9	173.5	173.5	164.9	164.9	128.9	128.9	-	-	-	12	
14	163.8	166.5	163.2	163.2	159.0	159.0	155.4	155.4	128.0	128.0	-	-	-	14	
16	149.5	151.9	150.6	150.8	146.7	146.7	143.2	143.2	126.7	126.7	98.3	98.3	98.3	16	
18	137.8	140.0	139.3	140.3	136.7	136.7	133.3	133.3	124.2	124.2	97.5	97.5	97.5	18	
20	126.9	129.1	128.5	130.4	127.3	127.3	124.0	124.0	120.7	120.7	96.7	96.7	96.7	20	
24	108.9	111.7	110.8	113.2	110.9	112.3	108.9	109.4	108.4	108.4	94.8	94.8	94.8	24	
28	92.1	94.2	94.6	98.3	94.9	98.5	95.4	97.0	95.5	96.8	91.0	91.3	91.3	28	
32	-	-	81.8	84.6	82.0	84.7	83.7	86.1	82.9	85.3	80.4	83.7	83.7	32	
36	-	-	70.4	74.2	71.0	74.3	72.6	75.9	71.7	75.1	69.2	74.0	74.0	36	
40	-	-	54.1	60.7	62.2	67.0	61.9	66.6	61.0	65.7	59.1	64.6	64.6	40	
48	-	-	-	-	46.6	53.8	46.3	53.6	45.3	52.9	44.6	51.6	51.6	48	
56	-	-	-	-	34.2	37.9	36.0	44.4	35.4	43.6	36.6	42.2	42.2	56	
64	-	-	-	-	-	-	29.0	37.1	30.1	36.2	29.3	34.9	34.9	64	
72	-	-	-	-	-	-	25.4	25.4	25.0	30.5	24.1	31.6	31.6	72	
80	-	-	-	-	-	-	-	-	21.1	25.6	21.0	27.1	27.1	80	
88	-	-	-	-	-	-	-	-	15.7	15.7	18.3	23.4	23.4	88	
96	-	-	-	-	-	-	-	-	-	-	15.9	18.6	18.6	96	
104	-	-	-	-	-	-	-	-	-	-	13.9	15.3	15.3	104	
1)	34.6	34.6	25.1	25.1	19.4	19.4	15.0	15.0	11.9	11.9	9.0	9.0	9.0	1)	

	360°	Max.	360°	Max.	360°	Max.	360°	Max.	360°	Max.	360°	Max.	360°	Max.
ft	121.7 ft	121.7 ft	135.2 ft	135.2 ft	148.6 ft	148.6 ft	162.1 ft	162.1 ft	175.5 ft	175.5 ft	196.2 ft	196.2 ft	196.2 ft	196.2 ft
1,000 lb														
20	79.3	79.3	-	-	-	-	-	-	-	-	-	-	-	20
24	77.7	77.7	61.6	61.6	-	-	-	-	-	-	-	-	-	24
28	73.6	73.6	60.8	60.8	48.6	48.6	-	-	-	-	-	-	-	28
32	68.7	68.7	58.6	58.6	48.2	48.2	39.1	39.1	-	-	-	-	-	32
36	62.9	63.4	55.4	55.4	46.9	46.9	38.9	38.9	32.0	32.0	-	-	-	36
40	56.6	58.1	51.9	52.1	45.3	45.3	38.6	38.6	31.9	31.9	23.1	23.1	23.1	40
48	45.2	49.3	42.2	45.4	40.2	40.7	36.3	36.3	31.4	31.4	23.1	23.1	23.1	48
56	34.9	41.9	34.2	39.3	33.2	36.3	32.4	33.1	29.8	29.8	23.1	23.1	23.1	56
64	28.6	36.1	28.6	33.9	27.5	32.0	27.5	29.8	26.9	27.9	23.0	23.0	23.0	64
72	24.4	30.5	23.3	29.2	23.9	28.1	22.8	26.7	23.0	25.6	21.9	22.1	22.1	72
80	20.4	25.8	20.4	25.5	20.0	24.4	19.8	23.8	19.1	23.2	18.0	20.7	20.7	80
88	17.4	22.1	17.4	22.5	16.9	21.4	16.9	21.2	16.0	20.9	14.9	19.0	19.0	88
96	15.3	19.7	15.1	19.6	14.2	18.8	14.2	19.0	13.3	18.5	12.2	17.2	17.2	96
104	13.4	18.1	12.8	17.1	11.9	17.0	11.9	16.6	11.1	16.0	10.0	15.6	15.6	104
112	11.6	12.3	10.9	14.9	10.0	14.9	10.0	14.2	9.2	14.4	8.1	13.6	13.6	112
120	-	-	9.4	13.3	8.5	13.4	8.5	12.4	7.6	12.6	6.5	11.7	11.7	120
128	-	-	8.0	11.7	7.2	11.9	7.2	11.2	6.2	11.0	5.2	10.1	10.1	128
136	-	-	-	-	6.0	10.1	6.0	10.3	4.9	9.6	4.0	8.7	8.7	136
144	-	-	-	-	-	-	4.9	9.3	4.0	8.4	2.9	7.5	7.5	144
152	-	-	-	-	-	-	-	-	3.0	7.4	-	6.3	6.3	152
160	-	-	-	-	-	-	-	-	-	6.4	-	5.4	5.4	160
168	-	-	-	-	-	-	-	-	-	-	-	4.5	4.5	168
176	-	-	-	-	-	-	-	-	-	-	-	3.8	3.8	176
1)	7.1	7.1	4.9	4.9	2.9	2.9	-	-	-	-	-	-	-	1)

1) Capacities with horizontal boom

* Max. values are valid only for specific superstructure positions

23,600 lb		25.3 ft x 23.0 ft				360° / Max.*								85%
ft	360° 41.0 ft	Max. 41.0 ft	360° 54.5 ft	Max. 54.5 ft	360° 67.9 ft	Max. 67.9 ft	360° 81.4 ft	Max. 81.4 ft	360° 94.8 ft	Max. 94.8 ft	360° 108.3 ft	Max. 108.3 ft	ft	
1,000 lb														
10	198.1	200.7	195.2	195.2	190.2	190.2	168.3	168.3	-	-	-	-	10	
12	178.1	182.6	177.8	177.9	173.5	173.5	164.9	164.9	128.9	128.9	-	-	12	
14	161.3	166.5	162.6	163.2	159.0	159.0	155.4	155.4	128.0	128.0	-	-	14	
16	147.3	151.9	148.7	150.8	146.7	146.7	143.2	143.2	126.7	126.7	98.3	98.3	16	
18	133.1	139.3	134.8	140.0	134.1	136.7	129.0	133.3	116.6	124.2	97.5	97.5	18	
20	119.1	126.9	121.3	129.1	121.0	126.7	114.1	123.7	109.0	120.6	95.3	96.7	20	
24	95.2	102.6	97.9	104.6	94.5	104.8	91.5	104.1	84.7	105.8	77.8	94.3	24	
28	69.8	85.2	74.4	87.2	76.3	87.3	73.4	89.1	68.3	88.0	63.9	83.8	28	
32	-	-	57.9	74.3	59.5	76.2	59.0	75.7	56.4	73.4	55.5	70.2	32	
36	-	-	47.4	64.8	48.8	65.7	48.6	65.4	48.2	62.9	47.6	60.4	36	
40	-	-	31.8	51.4	41.0	57.7	41.0	57.4	41.4	54.4	40.3	53.1	40	
48	-	-	-	-	30.5	44.2	31.0	43.9	30.3	42.1	30.9	42.9	48	
56	-	-	-	-	23.3	33.4	23.9	34.8	23.9	35.1	24.0	35.2	56	
64	-	-	-	-	-	-	18.8	28.2	19.2	29.5	18.9	28.6	64	
72	-	-	-	-	-	-	15.1	24.3	15.5	23.9	15.1	23.4	72	
80	-	-	-	-	-	-	-	-	12.6	20.0	12.2	20.4	80	
88	-	-	-	-	-	-	-	-	10.4	15.7	9.9	17.2	88	
96	-	-	-	-	-	-	-	-	-	-	8.1	14.8	96	
104	-	-	-	-	-	-	-	-	-	-	6.6	12.8	104	
1)	34.6	34.6	25.1	25.1	19.4	19.4	14.8	15.0	10.6	11.9	7.3	9.0	1)	

ft	360° 121.7 ft	Max. 121.7 ft	360° 135.2 ft	Max. 135.2 ft	360° 148.6 ft	Max. 148.6 ft	360° 162.1 ft	Max. 162.1 ft	360° 175.5 ft	Max. 175.5 ft	360° 196.2 ft	Max. 196.2 ft	ft
1,000 lb													
20	79.0	79.3	-	-	-	-	-	-	-	-	-	-	20
24	71.6	77.7	61.0	61.6	-	-	-	-	-	-	-	-	24
28	60.9	73.6	54.9	60.8	48.6	48.6	-	-	-	-	-	-	28
32	51.0	67.4	48.9	58.6	44.6	48.2	39.1	39.1	-	-	-	-	32
36	44.4	59.1	42.7	53.5	39.5	46.9	35.8	38.9	32.0	32.0	-	-	36
40	39.7	52.6	37.9	48.6	36.3	44.8	33.1	38.6	31.3	31.9	23.1	23.1	40
48	30.7	41.1	29.4	38.2	27.9	36.5	27.0	34.2	24.9	31.1	21.9	23.1	48
56	23.7	32.2	23.0	31.7	21.9	30.2	21.1	28.7	19.4	26.8	17.3	23.1	56
64	18.7	27.9	17.9	25.6	17.0	25.6	16.7	24.4	15.1	22.6	13.2	20.3	64
72	14.9	23.5	14.2	22.6	13.1	21.0	13.1	20.4	11.5	18.4	9.8	16.4	72
80	12.0	19.3	11.3	19.2	10.2	17.9	10.2	17.2	8.9	15.5	7.2	13.7	80
88	9.6	16.9	8.8	16.3	8.0	15.3	8.0	14.6	6.9	13.1	5.2	11.4	88
96	7.8	14.5	7.0	13.7	6.1	12.9	6.1	12.5	5.1	10.9	3.6	9.2	96
104	6.2	12.4	5.5	11.7	4.6	10.6	4.6	10.6	3.7	9.1	-	7.5	104
112	5.0	10.5	4.1	9.8	3.2	8.9	3.2	8.9	-	7.6	-	5.9	112
120	-	-	3.1	8.2	-	7.4	-	7.4	-	6.3	-	4.6	120
128	-	-	-	6.8	-	6.1	-	6.1	-	5.1	-	3.5	128
136	-	-	-	-	-	5.0	-	5.0	-	4.1	-	2.6	136
144	-	-	-	-	-	-	-	-	-	3.1	-	-	144
1)	4.9	7.1	2.2	4.9	-	2.9	-	-	-	-	-	-	1)

1) Capacities with horizontal boom

* Max. values are valid only for specific superstructure positions

		19,000 lb				25.3 ft x 23.0 ft				360° / Max.*				85%	
		360°	Max.	360°	Max.	360°	Max.	360°	Max.	360°	Max.	360°	Max.		
		41.0 ft	41.0 ft	54.5 ft	54.5 ft	67.9 ft	67.9 ft	81.4 ft	81.4 ft	94.8 ft	94.8 ft	108.3 ft	108.3 ft		
ft		1,000 lb												ft	
10		197.7	200.7	195.2	195.2	190.2	190.2	168.3	168.3	-	-	-	-	-	10
12		177.7	182.6	177.8	177.9	173.5	173.5	164.9	164.9	128.9	128.9	-	-	-	12
14		161.1	166.5	162.4	163.2	159.0	159.0	155.4	155.4	128.0	128.0	-	-	-	14
16		146.2	151.9	148.2	150.8	146.7	146.7	143.2	143.2	126.7	126.7	98.3	98.3	98.3	16
18		131.5	138.1	133.7	138.8	132.2	136.7	125.2	133.3	113.0	124.2	95.7	97.5	97.5	18
20		117.0	124.5	119.2	126.7	116.8	126.5	111.3	123.5	101.9	120.4	91.5	96.7	96.7	20
24		89.7	100.7	92.7	102.7	91.2	102.9	85.4	103.1	79.0	103.8	73.5	93.2	93.2	24
28		64.4	83.7	69.8	85.6	71.0	86.0	68.3	87.2	63.5	84.7	61.4	80.7	80.7	28
32		-	-	53.7	73.2	55.3	74.4	54.9	72.9	54.5	70.5	51.7	67.9	67.9	32
36		-	-	43.8	63.6	45.3	64.4	45.1	63.3	46.5	60.5	44.1	58.4	58.4	36
40		-	-	28.5	49.1	37.9	56.4	39.0	54.2	38.4	52.3	38.0	51.2	51.2	40
48		-	-	-	-	28.0	42.0	28.6	41.8	28.9	40.8	28.7	41.9	41.9	48
56		-	-	-	-	21.3	32.8	21.8	33.2	22.4	34.2	22.0	32.6	32.6	56
64		-	-	-	-	-	-	17.1	27.3	17.6	27.5	17.2	26.3	26.3	64
72		-	-	-	-	-	-	13.7	22.8	14.2	22.2	13.7	22.6	22.6	72
80		-	-	-	-	-	-	-	-	11.3	19.1	10.9	18.7	18.7	80
88		-	-	-	-	-	-	-	-	9.3	15.7	8.8	15.8	15.8	88
96		-	-	-	-	-	-	-	-	-	-	7.0	13.4	13.4	96
104		-	-	-	-	-	-	-	-	-	-	5.7	11.5	11.5	104
1)		34.6	34.6	25.1	25.1	19.0	19.4	13.2	15.0	9.5	11.9	6.2	9.0	9.0	1)

		360°	Max.	360°	Max.	360°	Max.	360°	Max.	360°	Max.	360°	Max.		
		121.7 ft	121.7 ft	135.2 ft	135.2 ft	148.6 ft	148.6 ft	162.1 ft	162.1 ft	175.5 ft	175.5 ft	196.2 ft	196.2 ft		
ft		1,000 lb												ft	
20		78,5	79,3	-	-	-	-	-	-	-	-	-	-	-	20
24		67,1	77,7	59,5	61,6	-	-	-	-	-	-	-	-	-	24
28		56,7	73,6	52,7	60,8	46,5	48,6	-	-	-	-	-	-	-	28
32		48,5	64,6	45,9	58,6	42,6	48,2	38,2	39,1	-	-	-	-	-	32
36		42,3	55,6	39,8	51,3	38,0	45,5	34,4	38,9	30,5	32,0	-	-	-	36
40		36,7	49,7	35,2	45,1	33,3	42,1	32,0	38,3	28,3	31,9	23,0	23,1	23,1	40
48		28,5	37,5	26,9	36,7	25,5	33,9	24,5	33,0	22,4	30,1	20,2	23,1	23,1	48
56		21,8	31,2	20,9	29,1	19,7	28,8	19,0	27,0	17,3	25,1	15,2	21,9	21,9	56
64		17,0	25,9	16,3	24,7	15,2	23,2	14,9	22,3	13,2	20,3	11,1	18,1	18,1	64
72		13,3	21,7	12,6	20,8	11,5	19,3	11,5	18,6	10,0	16,6	8,0	14,8	14,8	72
80		10,6	18,5	9,8	17,6	8,9	16,3	8,9	15,5	7,4	13,9	5,7	12,2	12,2	80
88		8,4	15,8	7,7	14,8	6,6	13,8	6,9	13,2	5,5	11,6	3,9	9,9	9,9	88
96		6,7	13,1	5,9	12,4	4,9	11,5	5,1	11,2	3,9	9,6	-	7,8	7,8	96
104		5,2	11,0	4,4	10,2	3,5	9,3	3,5	9,3	2,6	7,9	-	6,2	6,2	104
112		4,1	9,4	3,2	8,5	-	7,8	-	7,8	-	6,3	-	4,8	4,8	112
120		-	-	-	7,2	-	6,4	-	6,4	-	5,0	-	3,5	3,5	120
128		-	-	-	6,2	-	5,3	-	5,3	-	4,1	-	2,5	2,5	128
136		-	-	-	-	-	4,2	-	4,2	-	3,1	-	-	-	136
144		-	-	-	-	-	-	-	3,3	-	2,4	-	-	-	144
1)		3.7	7.1	-	4.9	-	2.9	-	-	-	-	-	-	-	1)

1) Capacities with horizontal boom

* Max. values are valid only for specific superstructure positions

		69,700 lb		25.3 ft x 15.4 ft		360° / Max.*						85%		
		360°	Max.	360°	Max.	360°	Max.	360°	Max.	360°	Max.	360°	Max.	
		41.0 ft	41.0 ft	54.5 ft	54.5 ft	67.9 ft	67.9 ft	81.4 ft	81.4 ft	94.8 ft	94.8 ft	108.3 ft	108.3 ft	
		1,000 lb												
ft														ft
10	-	200.7	-	195.2	-	190.2	-	168.3	-	-	-	-	-	10
12	162.6	182.6	164.1	177.9	164.4	173.5	162.6	164.9	128.9	128.9	-	-	-	12
14	145.6	166.5	147.2	163.2	147.4	159.0	147.0	155.4	126.3	128.0	-	-	-	14
16	131.5	151.9	133.0	150.8	133.2	146.7	128.8	143.2	118.9	126.7	98.3	98.3	-	16
18	118.1	140.0	120.4	140.3	120.8	136.7	114.2	133.3	107.2	124.2	92.7	97.5	-	18
20	104.5	129.1	107.5	130.4	108.0	127.3	103.2	124.0	94.9	120.7	87.4	96.7	-	20
24	76.4	111.7	80.4	113.2	81.7	112.3	81.5	109.4	77.2	108.4	72.1	94.8	-	24
28	59.1	94.2	62.5	99.6	63.7	99.6	63.6	97.6	62.8	96.8	62.0	91.3	-	28
32	-	-	50.6	87.9	51.7	88.0	51.6	88.4	52.5	87.3	52.0	84.5	-	32
36	-	-	42.7	77.5	43.7	77.6	43.7	78.9	44.8	77.9	44.0	75.9	-	36
40	-	-	31.0	63.2	37.6	67.9	38.5	69.4	37.8	68.7	38.1	67.4	-	40
48	-	-	-	-	29.1	56.4	29.5	56.2	29.5	55.3	29.3	54.0	-	48
56	-	-	-	-	23.0	39.1	23.3	46.0	23.4	45.1	23.6	43.7	-	56
64	-	-	-	-	-	-	19.1	37.7	19.3	36.8	19.1	35.5	-	64
72	-	-	-	-	-	-	15.7	25.4	15.9	30.6	15.7	31.6	-	72
80	-	-	-	-	-	-	-	-	13.6	25.6	13.3	27.1	-	80
88	-	-	-	-	-	-	-	-	11.6	15.7	11.3	23.4	-	88
96	-	-	-	-	-	-	-	-	-	-	9.7	18.6	-	96
104	-	-	-	-	-	-	-	-	-	-	8.3	15.3	-	104
1)	34.6	34.6	25.1	25.1	19.4	19.4	15.0	15.0	11.9	11.9	9.0	9.0	1)	

		360°	Max.	360°	Max.	360°	Max.	360°	Max.	360°	Max.	360°	Max.	
		121.7 ft	121.7 ft	135.2 ft	135.2 ft	148.6 ft	148.6 ft	162.1 ft	162.1 ft	175.5 ft	175.5 ft	196.2 ft	196.2 ft	
		1,000 lb												
ft														ft
20	78.3	79.3	-	-	-	-	-	-	-	-	-	-	-	20
24	67.3	77.7	59.9	61.6	-	-	-	-	-	-	-	-	-	24
28	58.0	73.6	53.4	60.8	47.9	48.6	-	-	-	-	-	-	-	28
32	50.3	68.7	48.1	58.6	44.1	48.2	39.1	39.1	-	-	-	-	-	32
36	43.6	63.4	42.2	55.4	39.7	46.9	36.2	38.9	32.0	32.0	-	-	-	36
40	37.4	58.1	37.4	52.1	36.7	45.3	34.0	38.6	31.5	31.9	23.1	23.1	-	40
48	29.2	49.3	28.8	45.4	28.0	40.7	28.2	36.3	26.6	31.4	22.7	23.1	-	48
56	23.3	42.2	22.7	39.3	22.0	36.3	22.0	33.1	21.4	29.8	19.7	23.1	-	56
64	18.9	36.5	18.4	33.9	17.7	32.0	17.7	29.8	17.1	27.9	16.1	23.0	-	64
72	15.5	30.6	15.1	29.2	14.4	28.1	14.4	26.7	13.7	25.6	13.1	22.1	-	72
80	13.1	25.8	12.5	25.5	12.0	24.4	12.0	23.8	11.3	23.2	10.7	20.7	-	80
88	11.1	22.1	10.6	22.5	9.9	21.4	9.9	21.2	9.3	20.9	8.6	19.0	-	88
96	9.4	19.7	8.9	19.6	8.3	18.8	8.3	19.0	7.7	18.5	7.0	17.2	-	96
104	8.1	18.1	7.4	17.1	7.0	17.0	7.0	16.6	6.3	16.0	5.7	15.6	-	104
112	7.0	12.3	6.3	14.9	5.9	14.9	5.9	14.2	5.2	14.4	4.3	13.6	-	112
120	-	-	5.5	13.3	4.8	13.4	4.8	12.4	3.9	12.6	3.1	11.7	-	120
128	-	-	4.5	11.7	3.9	11.9	3.9	11.2	3.0	11.0	-	10.1	-	128
136	-	-	-	-	3.0	10.1	3.0	10.3	-	9.6	-	8.7	-	136
144	-	-	-	-	-	-	-	9.3	-	8.4	-	7.5	-	144
152	-	-	-	-	-	-	-	-	-	7.4	-	6.3	-	152
160	-	-	-	-	-	-	-	-	-	6.4	-	5.4	-	160
168	-	-	-	-	-	-	-	-	-	-	-	4.5	-	168
176	-	-	-	-	-	-	-	-	-	-	-	3.8	-	176
1)	6.8	7.1	4.6	4.9	2.6	2.9	-	-	-	-	-	-	-	1)

1) Capacities with horizontal boom

* Max. values are valid only for specific superstructure positions

		57,800 lb		25.3 ft x 15.4 ft		360° / Max.*						85%	
ft	360° 41.0 ft	Max. 41.0 ft	360° 54.5 ft	Max. 54.5 ft	360° 67.9 ft	Max. 67.9 ft	360° 81.4 ft	Max. 81.4 ft	360° 94.8 ft	Max. 94.8 ft	360° 108.3 ft	Max. 108.3 ft	ft
1,000 lb													
10	181.0	200.7	182.4	195.2	182.6	190.2	168.2	168.3	-	-	-	-	10
12	160.2	182.6	161.8	177.9	162.0	173.5	158.7	164.9	127.6	128.9	-	-	12
14	143.4	166.5	145.1	163.2	145.2	159.0	132.8	155.4	120.1	128.0	-	-	14
16	129.4	151.9	131.2	150.8	126.2	146.7	117.6	143.2	106.5	126.7	95.4	98.3	16
18	110.9	140.0	113.2	140.3	109.8	136.7	103.6	133.3	94.2	124.2	86.5	97.5	18
20	92.0	129.1	94.8	130.4	98.1	127.3	90.9	124.0	83.1	120.7	78.2	96.7	20
24	66.8	111.7	70.9	113.2	72.1	112.3	71.9	109.4	67.8	108.4	65.8	94.8	24
28	51.5	94.2	55.0	98.3	56.1	98.5	55.9	97.0	57.1	96.8	55.2	91.3	28
32	-	-	44.2	84.6	46.0	84.7	46.8	86.1	46.5	85.3	45.8	83.7	32
36	-	-	37.2	74.2	39.1	74.3	39.9	75.9	39.3	75.1	39.3	74.0	36
40	-	-	26.3	60.7	33.3	67.0	33.7	66.6	33.7	65.7	33.7	64.6	40
48	-	-	-	-	25.1	53.5	25.5	53.2	26.0	52.5	25.7	51.1	48
56	-	-	-	-	19.8	37.4	20.0	42.3	20.5	41.4	20.3	39.9	56
64	-	-	-	-	-	-	16.1	34.4	16.6	33.3	16.4	34.2	64
72	-	-	-	-	-	-	13.3	25.4	13.7	28.5	13.3	29.0	72
80	-	-	-	-	-	-	-	-	11.4	24.9	11.2	24.3	80
88	-	-	-	-	-	-	-	-	9.7	15.7	9.4	21.0	88
96	-	-	-	-	-	-	-	-	-	-	7.9	17.8	96
104	-	-	-	-	-	-	-	-	-	-	6.7	15.3	104
1)	34.6	34.6	25.1	25.1	17.9	19.4	13.0	15.0	9.9	11.9	7.3	9.0	1)

ft	360° 121.7 ft	Max. 121.7 ft	360° 135.2 ft	Max. 135.2 ft	360° 148.6 ft	Max. 148.6 ft	360° 162.1 ft	Max. 162.1 ft	360° 175.5 ft	Max. 175.5 ft	360° 196.2 ft	Max. 196.2 ft	ft
1,000 lb													
20	72.4	79.3	-	-	-	-	-	-	-	-	-	-	20
24	59.8	77.7	55.4	61.6	-	-	-	-	-	-	-	-	24
28	51.9	73.6	48.7	60.8	43.9	48.6	-	-	-	-	-	-	28
32	45.5	68.7	43.3	58.6	40.8	48.2	36.9	39.1	-	-	-	-	32
36	38.8	63.4	37.9	55.4	36.1	46.9	33.2	38.9	29.9	32.0	-	-	36
40	33.7	58.1	32.8	52.1	31.6	45.3	30.4	38.6	27.8	31.9	23.0	23.1	40
48	25.5	48.9	24.9	45.4	24.2	40.7	24.1	36.3	22.3	31.4	20.2	23.1	48
56	20.0	40.7	19.6	38.4	18.8	36.3	18.9	33.1	18.0	29.8	16.1	23.1	56
64	16.1	33.2	15.7	31.9	15.0	31.1	15.0	29.8	14.4	27.9	12.8	23.0	64
72	13.3	27.5	12.6	27.8	12.0	26.8	12.0	26.1	11.3	25.6	10.2	22.1	72
80	10.9	23.5	10.5	23.5	9.8	22.4	9.8	23.0	9.2	22.4	8.1	20.7	80
88	9.2	21.1	8.7	20.2	8.1	20.2	8.1	19.7	7.4	19.3	6.3	18.7	88
96	7.7	18.5	7.2	17.3	6.6	17.7	6.6	16.8	5.9	17.0	4.8	16.0	96
104	6.5	16.0	5.9	15.8	5.4	15.3	5.4	14.7	4.6	14.6	3.5	13.5	104
112	5.5	12.3	5.0	13.8	4.1	13.4	4.1	13.4	3.5	12.5	-	11.6	112
120	-	-	3.9	12.3	3.1	11.7	3.1	11.7	-	10.9	-	10.0	120
128	-	-	3.1	11.1	-	10.2	-	10.2	-	9.4	-	8.5	128
136	-	-	-	-	-	8.9	-	8.9	-	8.0	-	7.1	136
144	-	-	-	-	-	-	-	7.8	-	6.9	-	5.8	144
152	-	-	-	-	-	-	-	-	-	5.8	-	5.0	152
160	-	-	-	-	-	-	-	-	-	5.0	-	4.2	160
168	-	-	-	-	-	-	-	-	-	-	-	3.4	168
176	-	-	-	-	-	-	-	-	-	-	-	2.7	176
1)	5.3	7.1	3.1	4.9	-	2.9	-	-	-	-	-	-	1)

1) Capacities with horizontal boom

* Max. values are valid only for specific superstructure positions

23,600 lb		25.3 ft x 15.4 ft				360° / Max.*								85%
ft	360° 41.0 ft	Max. 41.0 ft	360° 54.5 ft	Max. 54.5 ft	360° 67.9 ft	Max. 67.9 ft	360° 81.4 ft	Max. 81.4 ft	360° 94.8 ft	Max. 94.8 ft	360° 108.3 ft	Max. 108.3 ft	ft	
1,000 lb														
10	173.2	200.7	173.2	195.2	148.5	190.2	131.3	168.3	-	-	-	-	10	
12	149.5	182.6	135.0	177.9	121.2	173.5	106.2	164.9	94.5	128.9	-	-	12	
14	118.3	166.5	108.5	163.2	99.2	159.0	88.3	155.4	82.2	128.0	-	-	14	
16	90.1	151.9	90.9	150.8	83.2	146.7	77.0	143.2	70.7	126.7	65.3	98.3	16	
18	71.9	139.3	75.6	140.0	72.0	136.7	68.3	133.3	62.3	124.2	58.6	97.5	18	
20	57.0	126.9	61.6	129.1	63.4	126.7	59.6	123.7	56.0	120.2	51.9	96.7	20	
24	40.4	102.6	44.4	104.6	47.2	104.8	47.1	103.8	45.3	104.0	42.3	91.3	24	
28	30.2	85.2	33.7	87.2	36.4	87.2	36.9	87.1	36.8	82.2	35.1	75.6	28	
32	-	-	26.6	72.0	29.1	74.6	29.5	71.1	30.0	67.4	29.3	62.5	32	
36	-	-	21.9	59.2	24.1	60.7	24.6	59.6	25.1	56.8	24.7	53.7	36	
40	-	-	12.8	43.5	19.8	50.7	20.3	50.7	20.9	48.7	20.5	48.6	40	
48	-	-	-	-	14.5	37.9	15.0	37.7	15.4	38.8	15.1	36.5	48	
56	-	-	-	-	10.8	29.7	11.3	29.9	11.6	30.0	11.4	28.9	56	
64	-	-	-	-	-	-	8.6	23.9	9.0	23.7	8.6	23.7	64	
72	-	-	-	-	-	-	6.7	19.3	7.1	19.3	6.7	19.3	72	
80	-	-	-	-	-	-	-	-	5.5	16.1	5.3	15.8	80	
88	-	-	-	-	-	-	-	-	4.3	13.5	4.0	13.1	88	
96	-	-	-	-	-	-	-	-	-	-	2.8	11.1	96	
104	-	-	-	-	-	-	-	-	-	-	-	9.5	104	
1)	22.9	34.6	13.9	25.1	9.5	19.4	6.4	15.0	4.4	11.9	2.2	9.0	1)	

ft	360° 121.7 ft	Max. 121.7 ft	360° 135.2 ft	Max. 135.2 ft	360° 148.6 ft	Max. 148.6 ft	360° 162.1 ft	Max. 162.1 ft	360° 175.5 ft	Max. 175.5 ft	360° 196.2 ft	Max. 196.2 ft	ft
1,000 lb													
20	48.2	79.3	-	-	-	-	-	-	-	-	-	-	20
24	39.4	77.6	36.0	61.6	-	-	-	-	-	-	-	-	24
28	32.8	68.3	30.1	59.9	27.9	48.6	-	-	-	-	-	-	28
32	27.8	59.1	25.3	53.8	23.5	48.2	22.3	39.1	-	-	-	-	32
36	23.8	50.9	21.9	46.4	20.2	42.8	19.2	37.9	17.1	32.0	-	-	36
40	20.1	43.6	18.8	41.9	17.3	38.3	16.4	36.4	14.5	31.7	12.5	23.1	40
48	15.0	35.3	14.0	33.0	12.9	32.3	12.3	30.0	10.6	27.1	8.9	22.8	48
56	11.2	28.2	10.6	27.3	9.6	25.6	9.2	24.6	7.6	22.6	6.0	20.1	56
64	8.6	23.1	8.0	22.2	7.1	20.5	6.8	19.8	5.5	18.1	3.9	16.2	64
72	6.4	19.0	6.0	18.4	5.1	17.3	4.9	16.2	3.6	14.6	-	12.6	72
80	5.1	15.6	4.4	15.0	3.5	14.1	3.3	13.7	-	12.0	-	10.0	80
88	3.7	12.9	3.1	12.1	-	11.2	-	11.1	-	9.6	-	8.0	88
96	-	10.9	-	10.2	-	9.2	-	8.9	-	7.6	-	6.2	96
104	-	9.2	-	8.6	-	7.7	-	7.3	-	6.1	-	4.6	104
112	-	7.6	-	7.0	-	6.1	-	6.1	-	4.8	-	3.5	112
120	-	-	-	5.7	-	4.8	-	4.8	-	3.7	-	-	120
128	-	-	-	4.6	-	3.9	-	3.9	-	2.8	-	-	128
136	-	-	-	-	-	3.0	-	3.0	-	-	-	-	136
144	-	-	-	-	-	-	-	2.2	-	-	-	-	144
1)	-	7.1	-	4.9	-	2.6	-	-	-	-	-	-	1)

1) Capacities with horizontal boom

* Max. values are valid only for specific superstructure positions

19,000 lb		25.3 ft x 15.4 ft				360° / Max.*								85%
ft	360° 41.0 ft	Max. 41.0 ft	360° 54.5 ft	Max. 54.5 ft	360° 67.9 ft	Max. 67.9 ft	360° 81.4 ft	Max. 81.4 ft	360° 94.8 ft	Max. 94.8 ft	360° 108.3 ft	Max. 108.3 ft	ft	
1,000 lb														
10	171.7	200.7	164.6	195.2	137.5	190.2	121.7	168.3	-	-	-	-	10	
12	142.7	182.6	124.9	177.9	112.4	173.5	98.1	164.9	89.9	128.9	-	-	12	
14	109.6	166.5	101.8	163.2	91.8	159.0	82.7	155.4	76.1	128.0	-	-	14	
16	83.1	151.9	83.9	150.8	76.8	146.7	72.2	143.2	65.9	126.7	61.0	98.3	16	
18	66.2	138.1	69.8	138.8	67.1	136.7	63.1	133.3	58.8	124.2	54.1	97.5	18	
20	52.2	124.5	56.8	126.7	58.7	126.5	55.0	123.5	51.6	119.6	47.7	96.5	20	
24	36.8	100.7	40.7	102.7	43.7	102.8	43.3	101.9	41.6	97.9	38.7	87.8	24	
28	27.3	82.3	30.9	85.0	33.5	84.5	34.0	81.9	33.9	77.2	32.1	70.0	28	
32	-	-	24.1	69.1	26.6	70.0	27.0	67.1	27.7	63.5	26.8	58.5	32	
36	-	-	19.7	56.1	22.0	57.3	22.5	56.6	23.0	53.7	22.6	51.6	36	
40	-	-	11.1	40.5	18.1	48.6	18.5	48.1	19.0	45.8	18.7	44.5	40	
48	-	-	-	-	13.1	35.4	13.5	35.2	13.9	36.2	13.6	33.7	48	
56	-	-	-	-	9.7	27.5	10.1	28.1	10.4	27.3	10.2	27.7	56	
64	-	-	-	-	-	-	7.5	21.8	7.9	21.9	7.7	21.7	64	
72	-	-	-	-	-	-	5.8	17.5	6.0	17.7	5.8	17.5	72	
80	-	-	-	-	-	-	-	-	4.7	14.6	4.4	14.3	80	
88	-	-	-	-	-	-	-	-	3.6	12.3	3.1	11.9	88	
96	-	-	-	-	-	-	-	-	-	-	-	10.1	96	
104	-	-	-	-	-	-	-	-	-	-	-	8.5	104	
1)	20.5	34.6	12.3	25.1	8.4	19.4	5.5	15.0	3.5	11.9	-	9.0	1)	

ft	360° 121.7 ft	Max. 121.7 ft	360° 135.2 ft	Max. 135.2 ft	360° 148.6 ft	Max. 148.6 ft	360° 162.1 ft	Max. 162.1 ft	360° 175.5 ft	Max. 175.5 ft	360° 196.2 ft	Max. 196.2 ft	ft
1,000 lb													
20	44.3	79.3	-	-	-	-	-	-	-	-	-	-	20
24	36.2	75.6	32.9	61.6	-	-	-	-	-	-	-	-	24
28	30.1	63.9	27.3	57.5	25.2	48.6	-	-	-	-	-	-	28
32	25.3	55.2	22.9	50.3	21.3	45.7	19.9	39.1	-	-	-	-	32
36	21.7	46.6	19.6	44.3	18.1	40.6	17.0	36.5	15.2	32.0	-	-	36
40	18.3	41.9	16.6	38.5	15.3	37.6	14.5	34.6	12.7	31.4	10.7	23.1	40
48	13.5	32.7	12.3	31.5	11.2	29.7	10.6	28.0	9.1	25.4	7.2	22.1	48
56	9.9	26.6	9.2	24.6	8.2	23.2	7.8	22.3	6.2	20.4	4.7	18.1	56
64	7.5	21.4	6.8	20.2	5.9	18.6	5.5	17.8	4.1	16.0	-	14.2	64
72	5.6	17.3	4.9	16.4	4.0	15.3	3.8	14.6	2.5	12.8	-	10.9	72
80	4.2	13.9	3.5	13.2	-	12.4	-	12.0	-	10.5	-	8.7	80
88	2.9	11.7	-	10.7	-	9.8	-	9.7	-	8.4	-	6.9	88
96	-	9.8	-	9.1	-	8.0	-	7.8	-	6.7	-	5.1	96
104	-	8.1	-	7.5	-	6.6	-	6.2	-	5.0	-	3.7	104
112	-	6.8	-	6.1	-	5.2	-	5.0	-	3.9	-	-	112
120	-	-	-	4.9	-	4.2	-	4.0	-	2.8	-	-	120
128	-	-	-	4.0	-	3.2	-	3.1	-	-	-	-	128
136	-	-	-	-	-	2.4	-	-	-	-	-	-	136
1)	-	6.6	-	4.0	-	-	-	-	-	-	-	-	1)

1) Capacities with horizontal boom

* Max. values are valid only for specific superstructure positions

8,200 lb		25.3 ft x 8.4 ft				360° / Max.*								85%
ft	360° 41.0 ft	Max. 41.0 ft	360° 54.5 ft	Max. 54.5 ft	360° 67.9 ft	Max. 67.9 ft	360° 81.4 ft	Max. 81.4 ft	360° 94.8 ft	Max. 94.8 ft	360° 108.3 ft	Max. 108.3 ft	ft	
1,000 lb														
10	53.5	200.7	51.4	195.2	48.5	164.8	44.6	103.3	-	-	-	-	10	
12	41.2	182.6	41.6	177.9	40.1	167.2	37.2	104.7	33.1	75.4	-	-	12	
14	30.6	166.5	34.2	163.2	33.7	159.0	31.5	106.4	29.3	76.2	-	-	14	
16	23.5	151.9	27.5	150.8	28.7	146.7	26.9	108.5	25.2	77.2	22.9	59.0	16	
18	18.9	135.5	22.6	136.3	24.6	134.3	23.4	110.8	22.1	76.1	20.1	59.5	18	
20	15.0	119.3	18.3	121.4	20.7	120.6	20.3	110.5	19.3	76.3	17.5	59.5	20	
24	9.8	93.5	13.0	94.3	15.2	89.9	15.6	82.0	15.2	72.9	13.7	59.3	24	
28	6.3	67.4	9.3	71.4	11.4	67.7	11.8	62.3	11.9	58.6	10.7	55.1	28	
32	-	-	6.7	52.8	8.6	53.0	9.1	49.5	9.5	48.9	8.4	45.2	32	
36	-	-	4.6	42.3	6.8	43.0	7.2	42.3	7.6	40.8	6.6	39.2	36	
40	-	-	-	25.6	5.1	35.2	5.5	35.9	6.0	34.9	5.1	33.4	40	
48	-	-	-	-	-	25.1	-	25.2	-	25.6	-	24.7	48	
56	-	-	-	-	-	18.8	-	18.8	-	19.0	-	18.8	56	
64	-	-	-	-	-	-	-	14.9	-	15.3	-	14.6	64	
72	-	-	-	-	-	-	-	12.0	-	12.2	-	11.7	72	
80	-	-	-	-	-	-	-	-	-	10.0	-	9.4	80	
88	-	-	-	-	-	-	-	-	-	8.1	-	7.4	88	
96	-	-	-	-	-	-	-	-	-	-	-	6.1	96	
104	-	-	-	-	-	-	-	-	-	-	-	5.0	104	
1)	3.1	34.6	-	25.1	-	16.5	-	11.9	-	8.4	-	5.5	1)	

ft	360° 121.7 ft	Max. 121.7 ft	360° 135.2 ft	Max. 135.2 ft	360° 148.6 ft	Max. 148.6 ft	360° 162.1 ft	Max. 162.1 ft	360° 175.5 ft	Max. 175.5 ft	360° 196.2 ft	Max. 196.2 ft	ft
1,000 lb													
20	16,0	46,8	-	-	-	-	-	-	-	-	-	-	20
24	12,5	47,7	10,5	37,6	-	-	-	-	-	-	-	-	24
28	9,7	47,7	8,0	38,2	-	30,8	-	-	-	-	-	-	28
32	7,5	43,5	5,9	38,9	-	31,2	-	25,1	-	-	-	-	32
36	5,8	37,4	4,4	34,4	-	29,6	-	25,5	-	20,1	-	-	36
40	4,2	31,5	-	29,1	-	27,2	-	25,3	-	20,2	-	15,3	40
48	-	23,5	-	21,5	-	20,3	-	19,5	-	17,8	-	15,0	48
56	-	18,2	-	17,0	-	15,7	-	15,1	-	13,7	-	11,9	56
64	-	14,4	-	13,4	-	12,3	-	11,8	-	10,4	-	8,6	64
72	-	11,3	-	10,6	-	9,7	-	9,1	-	7,8	-	6,0	72
80	-	8,9	-	8,3	-	7,4	-	7,0	-	5,7	-	4,1	80
88	-	7,2	-	6,3	-	5,4	-	5,4	-	4,1	-	-	88
96	-	5,7	-	4,9	-	4,1	-	3,9	-	2,6	-	-	96
104	-	4,4	-	3,7	-	2,8	-	2,8	-	-	-	-	104
112	-	3,5	-	-	-	-	-	-	-	-	-	-	112
1)	-	3.3	-	-	-	-	-	-	-	-	-	-	1)

1) Capacities with horizontal boom

* Max. values are valid only for specific superstructure positions

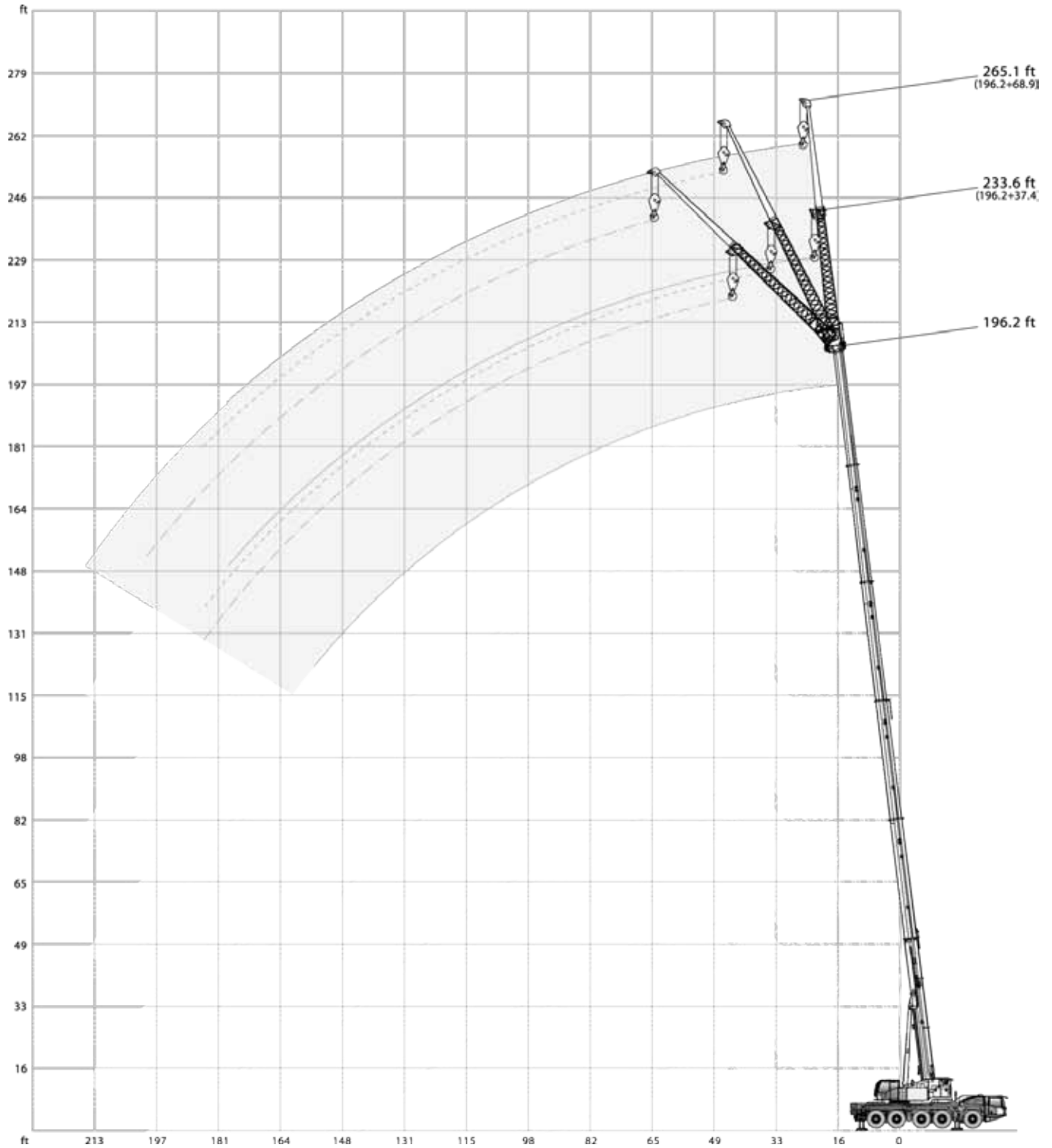
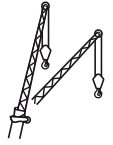

93,000 lb		25.3 ft x 23.0 ft		360°			85%			
41.0 ft										
ft	37.4 ft			68.9 ft			ft	108.3 ft		
	0°	20°	40°	0°	20°	40°		0°	20°	40°
1,000 lb										
10	36.6	-	-	22.0	-	-	20	36.6	-	-
12	36.6	-	-	21.8	-	-	24	36.6	-	-
14	36.6	-	-	21.7	-	-	28	36.6	-	-
16	36.6	-	-	21.4	-	-	32	36.6	-	-
18	36.6	-	-	21.2	-	-	36	36.6	-	-
20	36.6	34.6	-	20.9	-	-	40	36.5	28.7	-
24	36.6	31.9	-	20.4	-	-	48	35.0	26.9	21.2
28	36.6	29.5	-	19.7	-	-	56	31.5	25.0	20.4
32	35.3	27.5	22.5	18.9	-	-	64	28.4	23.3	19.7
36	32.6	25.8	21.5	17.9	-	-	72	25.8	21.6	19.2
40	29.9	24.3	20.6	16.8	13.6	-	80	23.8	20.3	18.6
48	25.8	21.7	19.3	14.9	12.3	-	88	22.2	19.3	17.9
56	22.5	19.9	18.6	13.2	11.2	9.7	96	20.7	18.3	17.4
64	19.9	18.9	-	11.7	10.3	9.1	104	18.4	17.5	17.0
72	-	-	-	10.6	9.5	8.6	112	16.0	16.6	16.6
80	-	-	-	9.8	9.0	8.3	120	14.0	14.5	-
88	-	-	-	9.1	8.5	8.2	128	12.7	12.8	-
96	-	-	-	8.5	8.2	-	136	7.6	7.6	-
							144	-	-	-
							152	-	-	-
							160	-	-	-

175.5 ft										
ft	37.4 ft			68.9 ft			ft	108.3 ft		
	0°	20°	40°	0°	20°	40°		0°	20°	40°
1,000 lb										
40	16.1	-	-	-	-	-	48	16.1	-	-
48	16.1	-	-	9.0	-	-	56	16.1	-	-
56	16.1	-	-	9.0	-	-	64	16.1	16.1	-
64	16.1	16.1	-	9.0	-	-	72	16.1	16.1	-
72	16.1	16.1	-	9.0	-	-	80	16.1	16.0	15.5
80	16.1	16.0	15.5	9.0	9.0	-	88	15.6	15.1	14.5
88	15.6	15.1	14.5	9.0	9.0	-	96	14.7	14.1	13.8
96	14.7	14.1	13.8	9.0	9.0	-	104	13.8	13.3	13.1
104	13.8	13.3	13.1	9.0	9.0	8.2	112	12.7	12.3	12.3
112	12.7	12.3	12.3	9.0	9.0	8.1	120	11.9	11.5	11.5
120	11.9	11.5	11.5	8.8	8.7	7.9	128	10.7	10.8	10.8
128	10.7	10.8	10.8	8.5	8.3	7.8	136	9.3	9.9	10.1
136	9.3	9.9	10.1	8.2	7.8	7.6	144	8.4	8.7	9.1
144	8.4	8.7	9.1	7.7	7.5	7.3	152	7.4	7.8	7.9
152	7.4	7.8	7.9	6.9	7.0	7.0	160	6.3	6.9	7.2
160	6.3	6.9	7.2	6.0	6.7	6.5	168	5.3	5.9	6.1
168	5.3	5.9	6.1	5.3	5.9	6.1	176	4.5	5.0	5.0
176	4.5	5.0	5.0	4.5	5.1	5.6	184	3.7	4.0	-
184	3.7	4.0	-	3.7	4.5	4.8	192	-	-	-
192	-	-	-	-	3.8	4.2	200	-	-	-
200	-	-	-	-	3.0	3.4				





196.2 ft										
ft	37.4 ft			68.9 ft			ft	108.3 ft		
	0°	20°	40°	0°	20°	40°		0°	20°*	40°*
1,000 lb										
48	11.7	-	-	-	-	-	56	11.7	-	-
56	11.7	-	-	6.6	-	-	64	11.7	-	-
64	11.7	-	-	6.6	-	-	72	11.7	11.7	-
72	11.7	11.7	-	6.6	-	-	80	11.7	11.7	11.7
80	11.7	11.7	11.7	6.6	-	-	88	11.7	11.7	11.7
88	11.7	11.7	11.7	6.6	7.1	-	96	11.7	11.7	11.7
96	11.7	11.7	11.7	6.6	7.1	-	104	11.7	11.7	11.7
104	11.7	11.7	11.7	6.6	7.1	-	112	11.4	11.4	11.4
112	11.4	11.4	11.4	6.6	7.1	7.1	120	10.7	10.8	10.7
120	10.7	10.8	10.7	6.6	7.1	7.1	128	10.0	10.0	10.1
128	10.0	10.0	10.1	6.6	7.1	7.1	136	8.9	9.4	9.4
136	8.9	9.4	9.4	6.6	7.1	7.1	144	7.6	8.4	8.6
144	7.6	8.4	8.6	6.6	6.8	6.6	152	6.2	7.1	7.5
152	6.2	7.1	7.5	6.2	6.5	6.4	160	5.2	5.8	6.3
160	5.2	5.8	6.3	5.2	6.1	6.1	168	4.2	4.8	5.2
168	4.2	4.8	5.2	4.2	5.6	5.8	176	3.4	3.9	4.1
176	3.4	3.9	4.1	3.4	4.7	5.3	184	-	3.1	3.3
184	-	3.1	3.3	-	3.9	4.5	192	-	-	-
192	-	-	-	-	-	3.6	200	-	-	-
200	-	-	-	-	-	2.8				





 * 191.6 ft





69,700 lb		25.3 ft x 23.0 ft		360°			85%			
41.0 ft										
ft	37.4 ft			68.9 ft			ft	108.3 ft		
	0°	20°	40°	0°	20°	40°		0°	20°	40°
1,000 lb										
10	36.6	-	-	22.0	-	-	20	36.6	-	-
12	36.6	-	-	21.8	-	-	24	36.6	-	17.0
14	36.6	-	-	21.7	-	-	28	36.6	-	16.9
16	36.6	-	-	21.4	-	-	32	36.6	-	16.6
18	36.6	-	-	21.2	-	-	36	36.6	-	16.3
20	36.6	34.6	-	20.9	-	-	40	36.5	28.7	16.1
24	36.6	31.9	-	20.4	-	-	48	35.0	26.9	15.6
28	36.6	29.5	-	19.7	-	-	56	31.5	25.0	15.2
32	35.3	27.5	22.5	18.9	-	-	64	28.4	23.3	14.7
36	32.6	25.8	21.5	17.9	-	-	72	25.8	21.6	14.3
40	29.9	24.3	20.6	16.8	13.6	-	80	22.6	20.3	13.8
48	25.8	21.7	19.3	14.9	12.3	-	88	19.6	19.2	13.0
56	22.5	19.9	18.6	13.2	11.2	9.7	96	16.7	17.6	12.1
64	19.9	18.9	-	11.7	10.3	9.1	104	14.7	15.1	11.3
72	-	-	-	10.6	9.5	8.6	112	12.9	13.3	10.8
80	-	-	-	9.8	9.0	8.3	120	11.7	11.9	10.0
88	-	-	-	9.1	8.5	8.2	128	10.2	10.6	9.5
96	-	-	-	8.5	8.2	-	136	7.6	7.6	8.6
							144	-	-	7.5
							152	-	-	7.2
							160	-	-	6.4





175.5 ft										
ft	37.4 ft			68.9 ft			ft	196.2 ft		
	0°	20°	40°	0°	20°	40°		0°	20°*	40°*
1,000 lb										
40	16.1	-	-	-	-	-	48	11.7	-	-
48	16.1	-	-	9.0	-	-	56	11.7	-	6.6
56	16.1	-	-	9.0	-	-	64	11.7	-	6.6
64	16.1	16.1	-	9.0	-	-	72	11.7	11.7	6.6
72	16.1	16.1	-	9.0	-	-	80	11.7	11.7	6.6
80	16.1	16.0	15.5	9.0	9.0	-	88	11.7	11.7	6.6
88	15.6	15.1	14.5	9.0	9.0	-	96	11.7	11.7	6.6
96	14.5	14.1	13.8	9.0	9.0	-	104	11.3	11.7	6.6
104	12.4	13.3	13.1	9.0	9.0	8.2	112	9.6	10.9	6.6
112	10.9	11.6	12.2	9.0	9.0	8.1	120	7.8	9.1	6.5
120	9.3	10.2	10.4	8.1	8.7	7.9	128	6.5	7.6	5.6
128	7.7	8.6	9.3	7.3	8.3	7.8	136	5.3	6.3	4.4
136	6.3	7.1	7.8	6.0	7.4	7.6	144	4.0	4.9	3.4
144	5.1	6.0	6.5	4.9	6.6	7.3	152	3.2	3.8	3.7
152	4.1	4.7	5.1	4.1	5.6	6.3	160	-	2.8	3.3
160	3.3	3.9	4.1	3.3	4.5	5.4	168	-	-	-
168	-	-	-	-	3.5	4.4	176	-	-	-
176	-	-	-	-	2.6	3.4				

 *191.6 ft

57,800 lb		25.3 ft x 23.0 ft		360°			85%		
 41.0 ft									
  37.4 ft									
 68.9 ft									
ft 0° 20° 40° 0° 20° 40°									
1,000 lb									
10	36.6	-	-	22.0	-	-			
12	36.6	-	-	21.8	-	-			
14	36.6	-	-	21.7	-	-			
16	36.6	-	-	21.4	-	-			
18	36.6	-	-	21.2	-	-			
20	36.6	34.6	-	20.9	-	-			
24	36.6	31.9	-	20.4	-	-			
28	36.6	29.5	-	19.7	-	-			
32	35.3	27.5	22.5	18.9	-	-			
36	32.6	25.8	21.5	17.9	-	-			
40	29.9	24.3	20.6	16.8	13.6	-			
48	25.8	21.7	19.3	14.9	12.3	-			
56	22.5	19.9	18.6	13.2	11.2	9.7			
64	19.9	18.9	-	11.7	10.3	9.1			
72	-	-	-	10.6	9.5	8.6			
80	-	-	-	9.8	9.0	8.3			
88	-	-	-	9.1	8.5	8.2			
96	-	-	-	8.5	8.2	-			

 108.3 ft									
  37.4 ft									
 68.9 ft									
ft 0° 20° 40° 0° 20° 40°									
1,000 lb									
20	36.6	-	-	-	-	-			
24	36.6	-	-	17.0	-	-			
28	36.6	-	-	16.9	-	-			
32	36.6	-	-	16.6	-	-			
36	36.6	-	-	16.3	-	-			
40	36.5	28.7	-	16.1	-	-			
48	35.0	26.9	21.2	15.6	-	-			
56	31.5	25.0	20.4	15.2	12.7	-			
64	28.0	23.3	19.7	14.7	11.8	-			
72	23.7	21.6	19.2	14.3	11.3	-			
80	19.8	20.0	18.6	13.8	10.7	9.0			
88	17.1	17.7	17.6	13.0	10.2	8.7			
96	15.0	15.3	15.6	12.1	9.6	8.5			
104	13.1	13.3	13.5	11.3	9.3	8.2			
112	11.2	11.8	10.2	10.5	9.0	8.1			
120	9.7	10.0	-	9.3	8.8	7.9			
128	8.9	9.0	-	8.5	8.5	7.9			
136	7.6	7.6	-	7.4	7.6	7.9			
144	-	-	-	6.4	7.1	7.3			
152	-	-	-	5.9	6.1	-			
160	-	-	-	5.3	4.8	-			

 175.5 ft									
  37.4 ft									
 68.9 ft									
ft 0° 20° 40° 0° 20° 40°									
1,000 lb									
40	16.1	-	-	-	-	-			
48	16.1	-	-	9.0	-	-			
56	16.1	-	-	9.0	-	-			
64	16.1	16.1	-	9.0	-	-			
72	16.1	16.1	-	9.0	-	-			
80	15.9	16.0	15.5	9.0	9.0	-			
88	14.1	15.1	14.5	9.0	9.0	-			
96	12.3	13.3	13.8	9.0	9.0	-			
104	10.2	11.5	12.2	8.5	9.0	8.2			
112	8.5	9.6	10.7	7.4	9.0	8.1			
120	7.0	8.0	8.8	6.1	7.8	7.9			
128	5.6	6.5	7.2	4.8	6.8	7.7			
136	4.4	5.2	5.8	3.9	5.6	6.9			
144	3.4	4.0	4.5	2.9	4.5	6.0			
152	-	3.0	3.4	-	3.6	4.7			
160	-	-	-	-	2.8	3.7			



 196.2 ft									
  37.4 ft									
 68.9 ft									
ft 0° 20° 40° 0° 20°* 40°*									
1,000 lb									
48	11.7	-	-	-	-	-			
56	11.7	-	-	6.6	-	-			
64	11.7	-	-	6.6	-	-			
72	11.7	11.7	-	6.6	-	-			
80	11.7	11.7	11.7	6.6	-	-			
88	11.7	11.7	11.7	6.6	7.1	-			
96	10.6	11.5	11.7	6.6	7.1	-			
104	8.4	10.0	11.1	6.6	7.1	-			
112	6.8	8.3	9.4	5.9	7.1	7.1			
120	5.4	6.7	7.8	4.4	6.9	7.1			
128	4.2	5.3	6.3	3.3	5.8	7.1			
136	3.1	4.2	4.9	-	4.7	6.3			
144	-	3.1	3.8	-	3.6	5.1			
152	-	-	-	-	-	4.0			
160	-	-	-	-	-	3.1			

 * 191.6 ft

HAV-VA

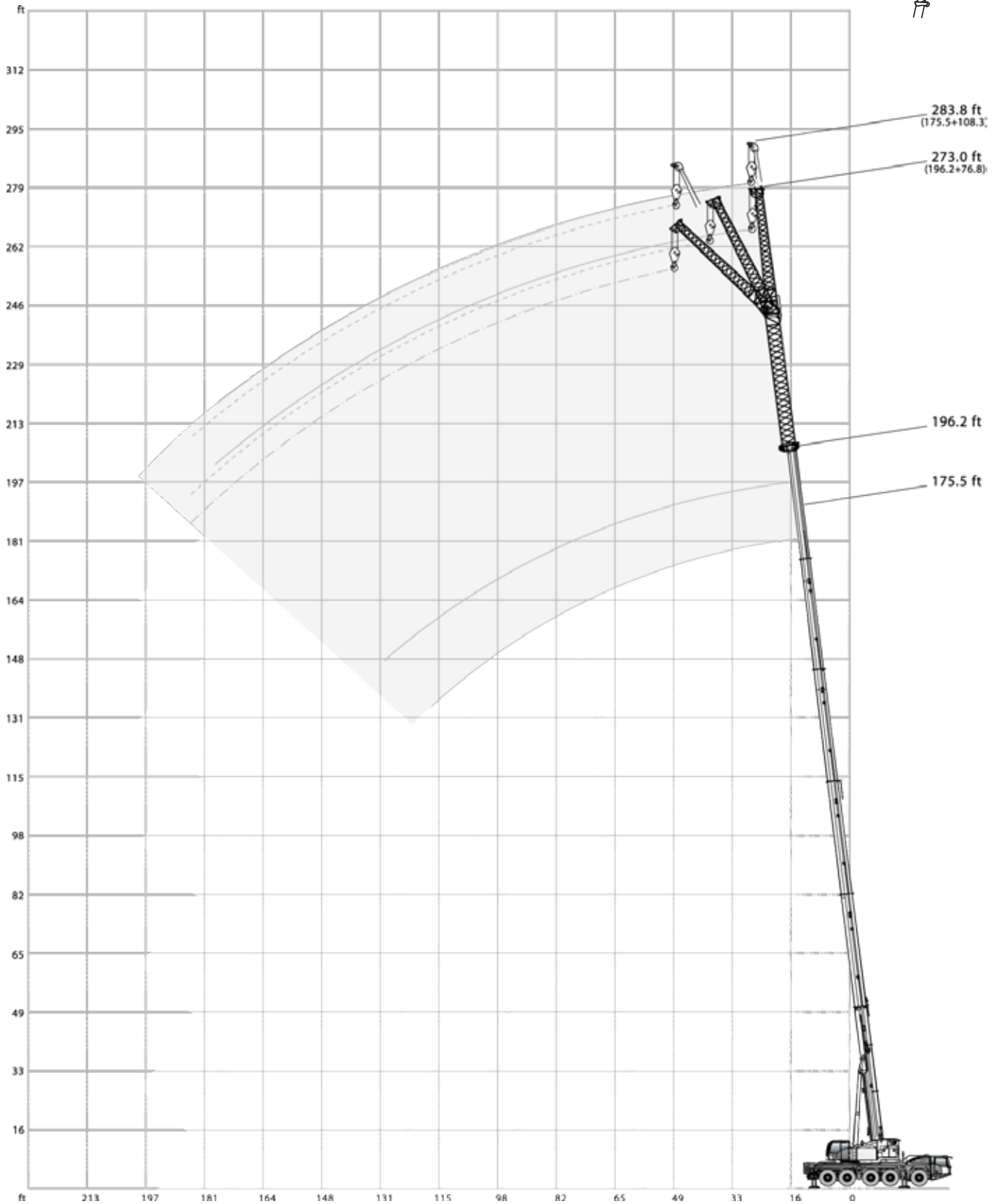
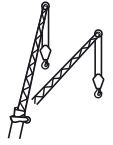
AC 130-5









93,000 lb		25.3 ft x 23.0 ft		360°		85%	
 41.0 ft				 108.3 ft			
		76.8 ft			108.3 ft		
		0°	20°	40°	0°	20°	40°
ft	1,000 lb						
14	36.6	-	-	-	-	-	-
16	36.6	-	-	-	-	-	-
18	35.7	-	-	-	-	-	-
20	34.6	-	-	17.0	-	-	-
24	31.6	-	-	16.7	-	-	-
28	28.6	-	-	16.4	-	-	-
32	25.7	22.3	-	16.1	-	-	-
36	23.5	20.5	-	15.9	-	-	-
40	21.5	19.0	17.5	15.5	-	-	-
48	18.0	16.4	15.4	14.1	13.0	-	-
56	15.4	14.4	13.6	12.5	11.4	-	-
64	13.6	12.8	12.2	11.1	10.1	-	-
72	12.2	11.5	11.0	9.7	9.1	-	-
80	10.9	10.4	10.2	8.7	8.0	-	-
88	9.8	9.4	9.4	7.9	7.3	-	-
96	8.8	8.8	-	7.1	6.6	-	-
104	8.2	8.0	-	6.3	6.0	-	-
112	-	-	-	5.7	5.5	-	-
120	-	-	-	5.2	5.2	-	-
128	-	-	-	4.8	4.7	-	-
136	-	-	-	4.5	-	-	-
32	22.3	-	-	-	-	-	-
36	22.2	-	-	12.1	-	-	-
40	22.0	-	-	12.1	-	-	-
48	21.3	19.0	-	12.1	-	-	-
56	19.9	17.4	-	11.8	-	-	-
64	18.4	15.9	14.3	11.5	-	-	-
72	17.0	14.6	13.5	11.0	10.2	-	-
80	15.4	13.7	12.5	10.5	9.4	-	-
88	14.2	12.7	11.9	10.0	8.8	-	-
96	13.1	11.9	11.2	9.3	8.1	-	-
104	12.2	11.1	10.6	8.7	7.6	-	-
112	11.4	10.6	10.1	8.1	7.0	-	-
120	10.7	10.0	9.6	7.6	6.7	-	-
128	10.0	9.5	9.3	7.1	6.3	-	-
136	9.4	8.9	8.9	6.7	6.0	-	-
144	8.8	8.6	8.6	6.2	5.5	-	-
152	8.3	8.1	4.4	5.9	5.3	-	-
160	7.7	7.6	-	5.4	5.0	-	-
168	3.7	3.6	-	5.2	4.8	-	-
176	3.5	3.3	-	4.9	4.6	-	-
184	-	-	-	4.7	4.5	-	-
192	-	-	-	4.4	-	-	-
200	-	-	-	3.6	-	-	-



 175.5 ft							
		76.8 ft		108.3 ft			
		0°	20°	40°	0°	20°	40°
ft	1,000 lb						
56	8.8	-	-	-	-	-	-
64	8.8	-	-	4.9	-	-	-
72	8.8	-	-	4.9	-	-	-
80	8.8	8.8	7.7	4.9	-	-	-
88	8.8	8.8	7.5	4.9	-	-	-
96	8.8	8.8	7.4	4.9	4.9	-	-
104	8.8	8.8	7.3	4.9	4.9	-	-
112	8.8	8.6	7.0	4.9	4.9	-	-
120	8.3	8.0	6.8	4.9	4.9	-	-
128	7.7	7.6	6.7	4.9	4.9	-	-
136	7.3	7.2	6.6	4.9	4.9	-	-
144	6.9	6.8	6.4	4.9	4.9	-	-
152	6.3	6.3	6.3	4.6	4.6	-	-
160	5.4	5.8	5.9	4.3	4.3	-	-
168	4.7	5.0	5.3	3.9	4.1	-	-
176	4.1	4.5	4.5	3.2	3.8	-	-
184	3.3	3.7	3.8	-	3.3	-	-



 196.2 ft				
		76.8 ft		
		0°	20°*	40°*
ft	1,000 lb			
64	6.0	-	-	-
72	6.0	-	-	-
80	6.0	6.4	-	-
88	6.0	6.4	6.1	-
96	6.0	6.4	6.0	-
104	6.0	6.4	6.0	-
112	6.0	6.4	5.7	-
120	6.0	6.4	5.7	-
128	6.0	6.4	5.6	-
136	6.0	6.4	5.5	-
144	6.0	6.2	5.5	-
152	5.6	5.7	5.5	-
160	4.6	5.3	5.3	-
168	3.8	4.7	5.0	-
176	3.0	3.9	4.3	-
184	-	3.1	3.4	-

 * 191.6 ft



69,700 lb		25.3 ft x 23.0 ft		360°		85%					
 41.0 ft											
 76.8 ft				 108.3 ft							
		0°		40°		0°		20°		40°	
ft		1,000 lb									
14	36.6	-	-	-	-	-	-	-	-	-	-
16	36.6	-	-	-	-	-	-	-	-	-	-
18	35.7	-	-	-	-	-	-	-	-	-	-
20	34.6	-	-	-	17.0	-	-	-	-	-	-
24	31.6	-	-	-	16.7	-	-	-	-	-	-
28	28.6	-	-	-	16.4	-	-	-	-	-	-
32	25.7	22.3	-	-	16.1	-	-	-	-	-	-
36	23.5	20.5	-	-	15.9	-	-	-	-	-	-
40	21.5	19.0	17.5	-	15.5	-	-	-	-	-	-
48	18.0	16.4	15.4	-	14.1	13.0	-	-	-	-	-
56	15.4	14.4	13.6	-	12.5	11.4	-	-	-	-	-
64	13.6	12.8	12.2	-	11.1	10.1	-	-	-	-	-
72	12.2	11.5	11.0	-	9.7	9.1	-	-	-	-	-
80	10.9	10.4	10.2	-	8.7	8.0	-	-	-	-	-
88	9.8	9.4	9.4	-	7.9	7.3	-	-	-	-	-
96	8.8	8.8	-	-	7.1	6.6	-	-	-	-	-
104	8.2	8.0	-	-	6.3	6.0	-	-	-	-	-
112	-	-	-	-	5.7	5.5	-	-	-	-	-
120	-	-	-	-	5.2	5.2	-	-	-	-	-
128	-	-	-	-	4.8	4.7	-	-	-	-	-
136	-	-	-	-	4.5	-	-	-	-	-	-

 108.3 ft											
 76.8 ft				 108.3 ft							
		0°		40°		0°		20°		40°	
ft		1,000 lb									
32	22.3	-	-	-	-	-	-	-	-	-	-
36	22.2	-	-	-	-	-	12.1	-	-	-	-
40	22.0	-	-	-	-	-	12.1	-	-	-	-
48	21.3	19.0	-	-	-	-	12.1	-	-	-	-
56	19.9	17.4	-	-	-	-	11.8	-	-	-	-
64	18.4	15.9	14.3	-	-	-	11.5	-	-	-	-
72	17.0	14.6	13.5	-	-	-	11.0	10.2	-	-	-
80	15.4	13.7	12.5	-	-	-	10.5	9.4	-	-	-
88	14.2	12.7	11.9	-	-	-	10.0	8.8	-	-	-
96	13.1	11.9	11.2	-	-	-	9.3	8.1	-	-	-
104	12.2	11.1	10.6	-	-	-	8.7	7.6	-	-	-
112	11.4	10.6	10.1	-	-	-	8.1	7.0	-	-	-
120	10.5	10.0	9.6	-	-	-	7.6	6.7	-	-	-
128	9.3	9.5	9.3	-	-	-	7.1	6.3	-	-	-
136	8.1	8.5	8.7	-	-	-	6.7	6.0	-	-	-
144	7.1	7.5	7.6	-	-	-	6.2	5.5	-	-	-
152	6.1	6.5	4.4	-	-	-	5.7	5.3	-	-	-
160	5.7	5.8	-	-	-	-	5.1	5.0	-	-	-
168	3.7	3.6	-	-	-	-	4.5	4.7	-	-	-
176	3.5	3.3	-	-	-	-	3.6	4.2	-	-	-
184	-	-	-	-	-	-	3.2	3.5	-	-	-
192	-	-	-	-	-	-	2.8	-	-	-	-
200	-	-	-	-	-	-	2.4	-	-	-	-

 175.5 ft											
 76.8 ft				 108.3 ft							
		0°		40°		0°		20°		40°	
ft		1,000 lb									
56	8.8	-	-	-	-	-	-	-	-	-	-
64	8.8	-	-	-	4.9	-	-	-	-	-	-
72	8.8	-	-	-	4.9	-	-	-	-	-	-
80	8.8	8.8	7.7	-	4.9	-	-	-	-	-	-
88	8.8	8.8	7.5	-	4.9	-	-	-	-	-	-
96	8.8	8.8	7.4	-	4.9	4.9	-	-	-	-	-
104	8.8	8.8	7.3	-	4.9	4.9	-	-	-	-	-
112	8.8	8.6	7.0	-	4.9	4.9	-	-	-	-	-
120	7.6	8.0	6.8	-	4.9	4.9	-	-	-	-	-
128	6.7	7.3	6.7	-	4.7	4.9	-	-	-	-	-
136	5.5	6.4	6.6	-	4.0	4.9	-	-	-	-	-
144	4.5	5.3	6.0	-	2.9	4.9	-	-	-	-	-
152	3.6	4.5	5.1	-	-	3.8	-	-	-	-	-
160	2.7	3.5	4.1	-	-	2.8	-	-	-	-	-

 196.2 ft							
 76.8 ft							
		0°		20°*		40°*	
ft		1,000 lb					
64	6.0	-	-	-	-	-	-
72	6.0	-	-	-	-	-	-
80	6.0	6.4	-	-	-	-	-
88	6.0	6.4	6.1	-	-	-	-
96	6.0	6.4	6.0	-	-	-	-
104	6.0	6.4	6.0	-	-	-	-
112	6.0	6.4	5.7	-	-	-	-
120	5.8	6.4	5.7	-	-	-	-
128	5.1	6.3	5.6	-	-	-	-
136	4.0	5.5	5.5	-	-	-	-
144	2.9	4.5	5.1	-	-	-	-
152	-	3.4	4.1	-	-	-	-
160	-	-	3.2	-	-	-	-

 * 191.6 ft

57,800 lb		25.3 ft x 23.0 ft		360°		85%	
 41.0 ft				 108.3 ft			
		76.8 ft			108.3 ft		
		0°	20°	40°	0°	20°	40°
ft	1,000 lb						
14	36.6	-	-	-	-	-	-
16	36.6	-	-	-	-	-	-
18	35.7	-	-	-	-	-	-
20	34.6	-	-	17.0	-	-	-
24	31.6	-	-	16.7	-	-	-
28	28.6	-	-	16.4	-	-	-
32	25.7	22.3	-	16.1	-	-	-
36	23.5	20.5	-	15.9	-	-	-
40	21.5	19.0	17.5	15.5	-	-	-
48	18.0	16.4	15.4	14.1	13.0	-	-
56	15.4	14.4	13.6	12.5	11.4	-	-
64	13.6	12.8	12.2	11.1	10.1	-	-
72	12.2	11.5	11.0	9.7	9.1	-	-
80	10.9	10.4	10.2	8.7	8.0	-	-
88	9.8	9.4	9.4	7.9	7.3	-	-
96	8.8	8.8	-	7.1	6.6	-	-
104	8.2	8.0	-	6.3	6.0	-	-
112	-	-	-	5.7	5.5	-	-
120	-	-	-	5.2	5.2	-	-
128	-	-	-	4.8	4.7	-	-
136	-	-	-	4.5	-	-	-

 175.5 ft							
		76.8 ft			108.3 ft		
		0°	20°	40°	0°	20°	40°
ft	1,000 lb						
56	8.8	-	-	-	-	-	-
64	8.8	-	-	4.9	-	-	-
72	8.8	-	-	4.9	-	-	-
80	8.8	8.8	7.7	4.9	-	-	-
88	8.8	8.8	7.5	4.9	-	-	-
96	8.8	8.8	7.4	4.9	4.9	-	-
104	8.1	8.8	7.3	4.9	4.9	-	-
112	7.0	7.8	7.0	4.8	4.9	-	-
120	5.6	6.7	6.8	3.9	4.9	-	-
128	4.4	5.5	6.2	2.9	4.6	-	-
136	3.3	4.4	5.2	-	3.8	-	-
144	2.5	3.4	4.2	-	2.7	-	-
152	-	-	3.2	-	-	-	-

 196.2 ft				
		76.8 ft		
		0°	20°*	40°*
ft	1,000 lb			
64	6.0	-	-	-
72	6.0	-	-	-
80	6.0	6.4	-	-
88	6.0	6.4	6.1	-
96	6.0	6.4	6.0	-
104	6.0	6.4	6.0	-
112	5.2	6.4	5.7	-
120	3.9	5.6	5.7	-
128	2.9	4.4	5.3	-
136	-	3.3	4.2	-
144	-	2.3	3.1	-

 *191.6 ft

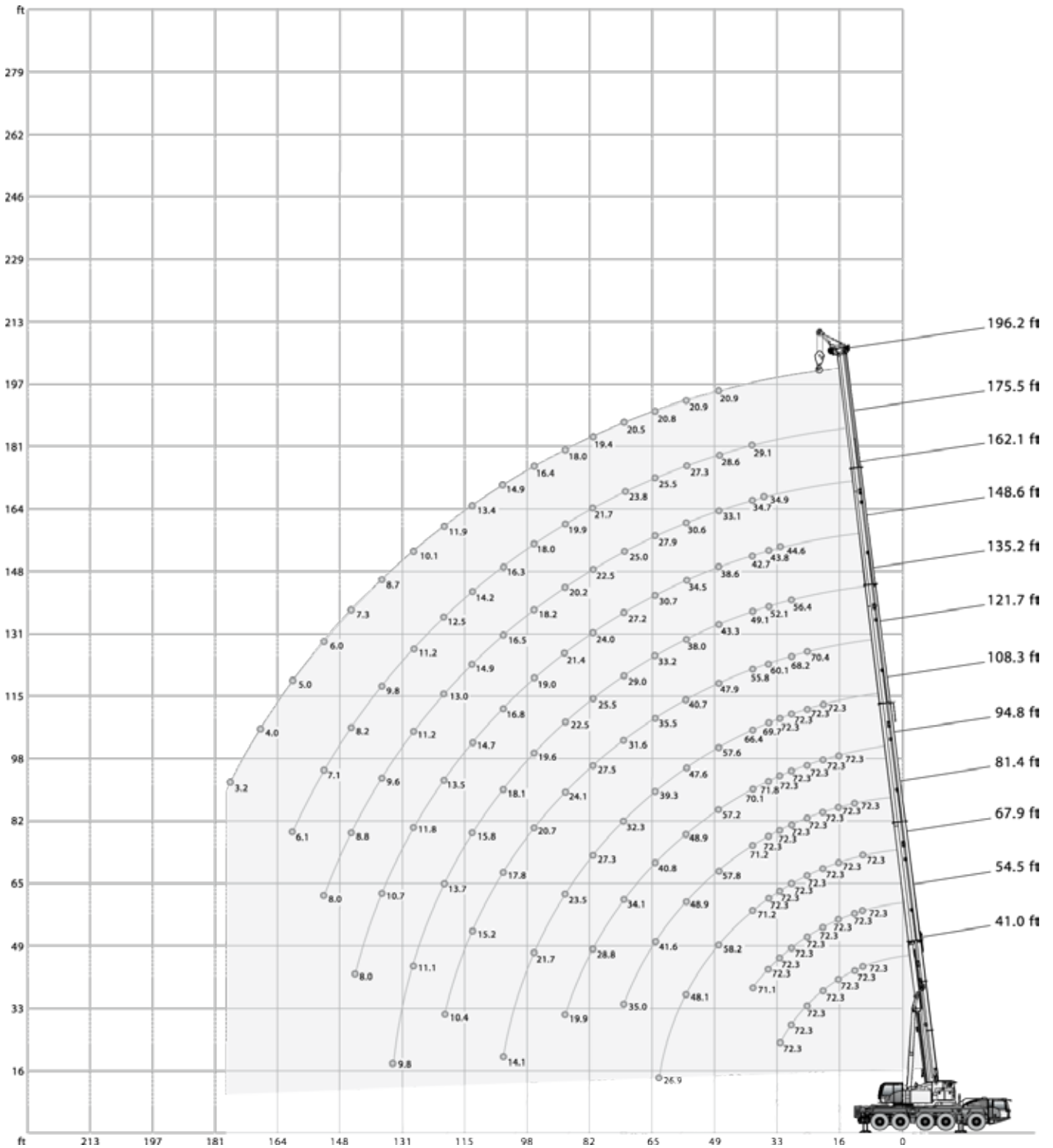

93,000 lb		25.3 ft x 23.0 ft											360°		85%	
ft	41.0 ft	54.5 ft	67.9 ft	81.4 ft	94.8 ft	108.3 ft	121.7 ft	135.2 ft	148.6 ft	162.1 ft	175.5 ft	196.2 ft	ft			
1,000 lb														ft		
10	72.3	72.3	72.3	-	-	-	-	-	-	-	-	-	-	10		
12	72.3	72.3	72.3	72.3	-	-	-	-	-	-	-	-	-	12		
14	72.3	72.3	72.3	72.3	-	-	-	-	-	-	-	-	-	14		
16	72.3	72.3	72.3	72.3	72.3	-	-	-	-	-	-	-	-	16		
18	72.3	72.3	72.3	72.3	72.3	-	-	-	-	-	-	-	-	18		
20	72.3	72.3	72.3	72.3	72.3	72.3	-	-	-	-	-	-	-	20		
24	72.3	72.3	72.3	72.3	72.3	72.3	70.4	-	-	-	-	-	-	24		
28	72.3	72.3	72.3	72.3	72.3	72.3	68.2	56.4	-	-	-	-	-	28		
32	72.3	72.3	72.3	72.3	72.3	72.3	64.4	54.9	44.6	-	-	-	-	32		
36	-	72.3	72.3	72.3	71.8	69.7	60.1	52.1	43.8	34.9	-	-	-	36		
40	-	71.1	71.2	71.2	70.1	66.4	55.8	49.1	42.7	34.7	29.1	-	-	40		
48	-	-	58.2	57.8	57.2	57.6	47.9	43.3	38.6	33.1	28.6	20.9	-	48		
56	-	-	48.1	48.9	48.9	47.6	40.7	38.0	34.5	30.6	27.3	20.9	56			
64	-	-	26.9	41.6	40.8	39.3	35.5	33.2	30.7	27.9	25.5	20.8	64			
72	-	-	-	35.0	34.1	32.3	31.6	29.0	27.2	25.0	23.8	20.5	72			
80	-	-	-	-	28.8	27.3	27.5	25.5	24.0	22.5	21.7	19.4	80			
88	-	-	-	-	19.9	23.5	24.1	22.5	21.4	20.2	19.9	18.0	88			
96	-	-	-	-	-	21.7	20.7	19.6	19.0	18.2	18.0	16.4	96			
104	-	-	-	-	-	14.1	17.8	18.1	16.8	16.5	16.3	14.9	104			
112	-	-	-	-	-	-	15.2	15.8	14.7	14.9	14.2	13.4	112			
120	-	-	-	-	-	-	10.4	13.7	13.5	13.0	12.5	11.9	120			
128	-	-	-	-	-	-	-	11.1	11.8	11.2	11.2	10.1	128			
136	-	-	-	-	-	-	-	9.8	10.7	9.6	9.8	8.7	136			
144	-	-	-	-	-	-	-	-	8.0	8.8	8.2	7.3	144			
152	-	-	-	-	-	-	-	-	-	8.0	7.1	6.0	152			
160	-	-	-	-	-	-	-	-	-	-	6.1	5.0	160			
168	-	-	-	-	-	-	-	-	-	-	-	4.0	168			
176	-	-	-	-	-	-	-	-	-	-	-	3.2	176			
1)	29.8	22.0	17.0	13.2	10.4	7.7	5.7	3.5	-	-	-	-	1)			





1) Capacities with horizontal boom





69,700 lb		25.3 ft x 23.0 ft											360°		85%	
ft	41.0 ft	54.5 ft	67.9 ft	81.4 ft	94.8 ft	108.3 ft	121.7 ft	135.2 ft	148.6 ft	162.1 ft	175.5 ft	196.2 ft	ft			
1,000 lb																
10	72.3	72.3	72.3	-	-	-	-	-	-	-	-	-	10			
12	72.3	72.3	72.3	72.3	-	-	-	-	-	-	-	-	12			
14	72.3	72.3	72.3	72.3	-	-	-	-	-	-	-	-	14			
16	72.3	72.3	72.3	72.3	72.3	-	-	-	-	-	-	-	16			
18	72.3	72.3	72.3	72.3	72.3	-	-	-	-	-	-	-	18			
20	72.3	72.3	72.3	72.3	72.3	72.3	-	-	-	-	-	-	20			
24	72.3	72.3	72.3	72.3	72.3	72.3	70.4	-	-	-	-	-	24			
28	72.3	72.3	72.3	72.3	72.3	72.3	68.2	56.4	-	-	-	-	28			
32	72.3	72.3	72.3	72.3	72.3	72.3	64.4	54.9	44.6	-	-	-	32			
36	-	70.3	70.4	70.1	69.4	69.7	60.1	52.1	43.8	34.9	-	-	36			
40	-	66.9	67.1	66.4	65.0	65.8	55.8	49.1	42.7	34.7	29.1	-	40			
48	-	-	51.9	52.7	52.4	50.7	47.5	43.3	38.6	33.1	28.6	20.9	48			
56	-	-	42.1	42.0	41.0	39.3	38.8	36.9	34.5	30.6	27.3	20.9	56			
64	-	-	24.8	33.9	32.8	31.8	31.8	30.6	29.7	27.9	25.5	20.8	64			
72	-	-	-	27.9	27.0	27.8	26.4	25.0	25.4	24.8	23.8	20.5	72			
80	-	-	-	-	23.1	23.4	21.9	22.3	21.2	21.4	21.0	19.4	80			
88	-	-	-	-	16.0	19.9	19.5	18.8	18.5	18.3	17.8	17.2	88			
96	-	-	-	-	-	17.1	17.3	15.8	16.3	15.4	15.2	14.1	96			
104	-	-	-	-	-	13.5	14.8	14.5	14.0	13.9	12.6	11.7	104			
112	-	-	-	-	-	-	11.2	12.5	11.8	11.8	10.7	9.6	112			
120	-	-	-	-	-	-	10.4	10.9	10.0	10.0	8.9	7.8	120			
128	-	-	-	-	-	-	-	9.4	8.5	8.5	7.4	6.3	128			
136	-	-	-	-	-	-	-	8.2	7.3	7.1	6.0	4.9	136			
144	-	-	-	-	-	-	-	-	5.6	6.0	4.9	3.8	144			
152	-	-	-	-	-	-	-	-	-	5.0	3.9	-	152			
160	-	-	-	-	-	-	-	-	-	-	3.1	-	160			
1)	29.8	22.0	17.0	13.2	10.4	7.7	5.7	3.5	-	-	-	-	1)			

1) Capacities with horizontal boom

57,800 lb		25.3 ft x 23.0 ft												360°		85%	
41.0 ft		54.5 ft	67.9 ft	81.4 ft	94.8 ft	108.3 ft	121.7 ft	135.2 ft	148.6 ft	162.1 ft	175.5 ft	196.2 ft					
ft	1,000 lb												ft				
10	72.3	72.3	72.3	-	-	-	-	-	-	-	-	-	-	10			
12	72.3	72.3	72.3	72.3	-	-	-	-	-	-	-	-	-	12			
14	72.3	72.3	72.3	72.3	-	-	-	-	-	-	-	-	-	14			
16	72.3	72.3	72.3	72.3	72.3	-	-	-	-	-	-	-	-	16			
18	72.3	72.3	72.3	72.3	72.3	72.3	-	-	-	-	-	-	-	18			
20	72.3	72.3	72.3	72.3	72.3	72.3	-	-	-	-	-	-	-	20			
24	72.3	72.3	72.3	72.3	72.3	72.3	70.4	-	-	-	-	-	-	24			
28	72.3	72.3	72.3	72.3	72.3	72.3	68.2	56.4	-	-	-	-	-	28			
32	72.3	72.3	72.3	72.3	72.3	72.3	64.4	54.9	44.6	-	-	-	-	32			
36	-	67.6	67.7	67.2	66.8	66.7	60.1	52.1	43.8	34.9	-	-	-	36			
40	-	61.2	61.5	60.4	62.1	59.6	55.5	49.1	42.7	34.7	29.1	-	-	40			
48	-	-	47.4	47.2	46.1	44.3	43.9	42.1	38.5	33.1	28.6	20.9	-	48			
56	-	-	36.8	36.8	35.7	35.0	34.8	33.7	32.5	30.6	27.3	20.9	56				
64	-	-	23.6	29.4	28.4	29.3	28.0	27.5	27.0	26.1	25.5	20.8	64				
72	-	-	-	24.1	25.0	24.1	23.4	23.0	22.8	22.4	21.7	20.5	72				
80	-	-	-	-	21.1	20.0	20.4	19.1	19.5	18.8	18.4	17.1	80				
88	-	-	-	-	14.2	17.5	17.2	17.0	16.2	16.2	15.1	13.9	88				
96	-	-	-	-	-	15.5	14.5	14.3	13.5	13.5	12.4	11.3	96				
104	-	-	-	-	-	13.4	12.8	12.2	11.3	11.3	10.2	9.1	104				
112	-	-	-	-	-	-	11.1	10.3	9.4	9.4	8.3	7.2	112				
120	-	-	-	-	-	-	9.4	8.7	7.8	7.8	6.7	5.6	120				
128	-	-	-	-	-	-	-	7.3	6.5	6.4	5.3	4.2	128				
136	-	-	-	-	-	-	-	6.2	5.3	5.2	4.0	2.9	136				
144	-	-	-	-	-	-	-	-	3.6	4.2	3.1	-	144				
152	-	-	-	-	-	-	-	-	-	3.2	-	-	152				
1)	29.8	22.0	17.0	13.2	10.4	7.7	5.7	3.5	-	-	-	-	1)				

1) Capacities with horizontal boom

 23,600 lb		 25.3 ft x 23.0 ft												360°		85%	
 		41.0 ft	54.5 ft	67.9 ft	81.4 ft	94.8 ft	108.3 ft	121.7 ft	135.2 ft	148.6 ft	162.1 ft	175.5 ft	196.2 ft				
ft	1,000 lb												ft				
10	72.3	72.3	72.3	-	-	-	-	-	-	-	-	-	-	-	10		
12	72.3	72.3	72.3	72.3	-	-	-	-	-	-	-	-	-	-	12		
14	72.3	72.3	72.3	72.3	-	-	-	-	-	-	-	-	-	-	14		
16	72.3	72.3	72.3	72.3	72.3	-	-	-	-	-	-	-	-	-	16		
18	72.3	72.3	72.3	72.3	72.3	-	-	-	-	-	-	-	-	-	18		
20	72.3	72.3	72.3	72.3	72.3	72.3	68.3	-	-	-	-	-	-	-	20		
24	72.3	72.3	72.3	72.3	72.3	71.3	58.7	-	-	-	-	-	-	-	24		
28	68.5	70.0	70.1	69.7	67.4	63.8	50.8	53.4	-	-	-	-	-	-	28		
32	56.1	58.6	59.7	60.1	56.4	53.0	43.4	46.5	42.4	-	-	-	-	-	32		
36	-	48.4	50.2	49.9	47.6	46.1	38.3	40.8	37.6	33.1	-	-	-	-	36		
40	-	39.8	40.9	40.7	40.5	40.5	30.0	35.9	34.7	32.6	28.7	-	-	-	40		
48	-	-	30.0	31.0	30.7	29.8	23.4	29.1	27.4	26.2	23.8	20.1	-	-	48		
56	-	-	23.5	24.0	23.7	23.7	18.3	22.5	21.2	20.5	18.4	16.3	56	-	56		
64	-	-	18.3	18.8	18.9	18.8	14.4	17.7	16.5	16.0	14.2	12.1	64	-	64		
72	-	-	-	15.1	15.3	14.9	11.5	13.8	12.6	12.4	10.7	8.7	72	-	72		
80	-	-	-	-	12.4	12.0	9.1	10.6	9.8	9.8	8.0	6.3	80	-	80		
88	-	-	-	-	10.1	9.6	7.2	8.3	7.4	7.4	5.8	4.2	88	-	88		
96	-	-	-	-	-	7.6	5.7	6.4	5.6	5.4	4.2	-	96	-	96		
104	-	-	-	-	-	6.1	4.3	4.8	3.9	3.9	2.8	-	104	-	104		
112	-	-	-	-	-	-	3.3	3.5	-	-	-	-	112	-	112		
120	-	-	-	-	-	-	-	-	-	-	-	-	120	-	120		
1)	29.8	22.0	17.0	12.3	8.8	5.7	3.5	-	-	-	-	-	1)	-	1)		

 19,000 lb		 25.3 ft x 23.0 ft												360°		85%	
 		41.0 ft	54.5 ft	67.9 ft	81.4 ft	94.8 ft	108.3 ft	121.7 ft	135.2 ft	148.6 ft	162.1 ft	175.5 ft	196.2 ft				
ft	1,000 lb												ft				
10	72.3	72.3	72.3	-	-	-	-	-	-	-	-	-	-	-	10		
12	72.3	72.3	72.3	72.3	-	-	-	-	-	-	-	-	-	-	12		
14	72.3	72.3	72.3	72.3	-	-	-	-	-	-	-	-	-	-	14		
16	72.3	72.3	72.3	72.3	72.3	-	-	-	-	-	-	-	-	-	16		
18	72.3	72.3	72.3	72.3	72.3	-	-	-	-	-	-	-	-	-	18		
20	72.3	72.3	72.3	72.3	72.3	72.3	-	-	-	-	-	-	-	-	20		
24	72.3	72.3	72.3	72.3	71.3	69.9	66.4	-	-	-	-	-	-	-	24		
28	66.0	67.4	67.5	67.2	63.5	59.4	56.0	50.3	-	-	-	-	-	-	28		
32	51.9	54.4	56.7	56.0	52.3	50.1	47.0	44.7	40.4	-	-	-	-	-	32		
36	-	45.4	46.6	46.4	44.2	43.9	40.8	38.8	35.9	31.7	-	-	-	-	36		
40	-	36.8	37.9	37.7	39.0	37.3	36.1	35.0	32.6	29.8	27.6	-	-	-	40		
48	-	-	28.2	29.0	28.4	28.6	28.4	26.6	24.8	23.8	21.5	19.1	48	-	48		
56	-	-	21.6	22.0	22.1	22.0	21.6	20.6	19.0	18.4	16.3	14.2	56	-	56		
64	-	-	16.7	17.2	17.4	17.2	16.7	15.9	14.9	14.2	12.2	10.2	64	-	64		
72	-	-	-	13.5	13.7	13.3	12.9	12.2	11.1	10.9	8.9	7.1	72	-	72		
80	-	-	-	-	11.1	10.6	10.2	9.3	8.4	8.3	6.5	4.7	80	-	80		
88	-	-	-	-	8.8	8.4	8.0	7.1	6.2	6.2	4.5	-	88	-	88		
96	-	-	-	-	-	6.5	6.1	5.3	4.5	4.5	2.9	-	96	-	96		
104	-	-	-	-	-	5.0	4.6	3.7	3.0	2.8	-	-	104	-	104		
112	-	-	-	-	-	-	3.5	-	-	-	-	-	112	-	112		
1)	29.8	22.0	16.1	11.0	7.7	4.9	2.6	-	-	-	-	-	1)	-	1)		

1) Capacities with horizontal boom

Ratings are in compliance with ASME B30.5.
Lifting capacities do not exceed 85 % of tipping load.

Consult operation manual for further details.

Note: Data published herein is intended as a guide only and shall not be construed to warrant applicability for lifting purposes. Crane operation is subject to the computer charts and operation manual both supplied with the crane.

Basic machine

Equipment carrier

Engine 368-4; Euromot 4/Tier 4F	Scania DC13; Diesel engine; 368 kW / 2100 1/min (500 HP), torque 2373 Nm / 1300 1/min; The engine complies with Euromot 4/Tier 4F; Exhaust system complete stainless steel.
Fuel tank	Fuel tank 127 gallons Diesel (no RME / biodiesel); 16 gallons AdBlue tank.
Transmission AS12INT	ZF AS-Tronic; Automated gearbox with integrated hydraulic retarder, 12 forward speeds and 2 reverse; 1-stage transfer case with switchable longitudinal lock.
Axles 10 x 6 x 10	10 x 6 x 10; Five axles, axles 2, 4, 5 are driven and dispose of a selectable transverse lock; Axle 4 with selectable longitudinal lock; All axles steered.
Suspension	Hydropneumatic suspension with axle load compensation; Hydraulically lockable.
Steering	Dual-circuit steering system with independent rear axle steering; Axles 1, 2, 3 mechanically connected; Axles 4 and 5 electro-hydraulically connected, all axles steered with 6 different steering programs.
Brakes	Pneumatic dual circuit service brake, acting on all wheels; Disc brakes; Hydraulic retarder integrated into transmission as wear-free sustained-action brake; Additional exhaust brake; Parking brake.
Tires size 385/95 R25 (14.00R25)	Tires size 385/95 R25 (14.00R25); Steel rim 9,5-25/1,7"; Magna MA03 170F or similar.
Carrier cab 2500	S-PACE type 8.20 ft; Adjustable driver seat, armrests and pneumatic suspension; Height and tilt-adjustable steering wheel; Auxiliary / passenger seat; Powered door windows; Tinted glass; Central door locking; Electrically adjustable rear-view mirrors, heated; Preparation for radio.
Carrier heating	Engine-dependent warm water heating with 12 kW heating power.
Drive lights	Including low beams, high beams, daytime running lights.
Electronic immobilizer system	Prevents uncontrolled carrier mobilization; Incl. 3 electronic keys.
Pneumatic system adapter for inflating tires	Pneumatic system adapter for inflating tires makes it possible for operators to inflate tires by themselves.
Jump starting device	Jump starting installation designed to make it possible to jump-start using a separate source of power.
Contour safety marking	Continuous reflective strips on the sides of the chassis and on the rear.

Equipment superstructure

Telescopic boom HA60	41.0 ft - 196.2 ft; Single cylinder telescoping system, automatic telescoping; Attachments for all equipment and extensions; 4 sheaves integrated in boom head for max. capacity of 141,800 lb.
Boom luffing	1 luffing cylinder with automatic lowering brake valve.
Rotary drive	Single slewing gear unit with spring-loaded multi-disc brake; Different operating modes selectable.
H1	Hoist with spring-loaded multi-disc brake; Resolver (hoist rotation indicator); Rope twist prevention is not included.
Counterweight 69,700 lb	Counterweight 69,700 lb, 6 pieces (a-f).
Outriggers	H-4-point design; Vertical and horizontal movement fully hydraulic; 3 outrigger bases: 8.4 ft, 15.4 ft, 23.0 ft.
Outrigger pads 038PA	4 round polyamide outrigger pads A = 1.25 ft ² with transport position at vertical cylinder.
Outrigger basis monitoring	Individual monitoring of horizontal stroke; Deviation warning in crane cab.
Control system	Enabling 4 simultaneous working movements; Electric pilot controls via 2 two-axis joysticks; Different control modes selectable for hydraulic circuits.
Operator aids	IC-1, with integrated electronic load moment indicator in accordance with EN13000; Color display; Displaying of current operating conditions, load charts, fault indicator; Signal lights indicating LMI-load; Crane data logger.
Crane cab 875	S-PACE type 875; Tilt infinitely variable 16°; Sliding window rear; Fold-out front window; Extendable side pedestal, front pedestal; Handrails; Tinted safety glass; Pull-down sun visor; Preparation for radio.
Heating crane cab	Engine-independent warm water heating with 5 kW heating power.
Anemometer	Removable, to be used with all extensions.

Additional equipment

Carrier

Engine 331-3a; Euromot 3a / Tier 3	Scania DC13; Diesel engine; 331 kW / 2100 ¹ /min (450 HP), torque 2007 Nm / 1575 ¹ /min; The engine complies with Euromot 3a / Tier 3; Exhaust system optional with spark arrester.
Axles 10 x 8 x 10	10 x 8 x 10; Five axles, axles 1, 2, 4, 5 are driven and dispose of a selectable transverse lock; Axles 2 and 4 with a disengageable center-differential lock; All axles steered.
Additional fuel tank	Additional fuel tank 37 gallons; For 164 gallons diesel total in carrier (no RME / biodiesel).
Air conditioning	Air conditioning for carrier cab, 7 kW rated cooling power.

Superstructure

S1 Heavy lift attachment, stage 1	2 additional sheaves; Dis-/connectable; For total 6 sheaves at boom head; Max. capacity 202,400 lb.
2. hoist (H2)	2. hoist; Spring-loaded multi-disc brake; Integrated resolver (hoist rotation indicator); Incl. quick couplings and transport rack; Rope twist prevention is not included.
Additional counterweight 23,400 lb	Additional counterweight 23,400 lb; 2 pieces; for total 93,100 lb, 8 pieces.
Air conditioning	Air conditioning in crane cab with 5 kW rated cooling power.

Handling

Remote control	Control of superstructure movements via wireless remote control.
Outrigger load indicator	The outrigger load is indicated in the operator cab and the outrigger control box.
Working range limiter IC-1 Plus	Displaying and programmability of the work range limits by IC-1. Smart crane control system enabling higher lifting capacities especially over outriggers. Enables safe use of the full capacity of the crane even in asymmetric outrigger configurations. Outriggers can be positioned independently. Capacity precalculation for +/- 30° slewing angle and radius area. Provided with graphical lift planning application. In-cab lift simulation.

Extensions

HAV 36.1 ft	37.4 ft; Lattice swing-away jib, manually offsettable 20°/40°; 1-sheaved head; Incl. transport storage; Cannot be carried while maintaining 26,500 lb axle load.
HAV 68.9 ft	68.9 ft; Double folding swing-away jib, manually offsettable 20°/40°; 1-sheaved head; Incl. transport storage; Cannot be carried while maintaining 26,500 lb axle load; Includes HAV 36.1 ft.
HAV-VA 108.3 ft	108.3 ft; Variable extension; Single piece, 39.4 ft lattice boom extension and double folding swing-away jib, manually offsettable 20°/40°; 1-sheaved head; Incl. transport storage for double folding swing-away jib; Includes HAV 36.1 ft, HAV 68.9 ft and HAV-VA 75.5 ft.
HAV-HY	Hydraulic offset 0°-40° instead of manual offset 20°/40°; available for HAV 36.1 ft, HAV 68.9 ft, HAV-VA 108.3 ft.
MS (runner)	5.25 ft; Fixed angle runner; 2 sheaves, for max. 72,300 lb lifting capacity; Incl. transport storage at boom head.

Hook Blocks

Hook block 160-7-21-D-1500	160-7-21-D (3310 lb); Hook block with ramshorn hook; white with red signal stripes.
Hook block 125-5-21-D-1125	125-5-21-D (2480 lb); Hook block with ramshorn hook; white with red signal stripes.
Hook block 80-3-21-D-850	80-3-21-D (1870 lb); Hook block with ramshorn hook; white with red signal stripes.
Hook block 32-1-21-D-600	32-1-21-D (1320 lb); Hook block with ramshorn hook; white with red signal stripes.
Hook 12-0V-E-350	12-0V-E (770 lb); Single hook with vertical swivel; red.

Further additional equipment on request!

Weight data may deviate from posted values based on road / travel configuration, equipment configuration, and component weight tolerances.

Effective Date: July 2016.

Product specifications and prices are subject to change without notice or obligation. The photographs and/or drawings in this document are for illustrative purposes only. Refer to the appropriate Operator's Manual for instructions on the proper use of this equipment. Failure to follow the appropriate Operator's Manual when using our equipment or to otherwise act irresponsibly may result in serious injury or death. The only warranty applicable to our equipment is the standard written warranty applicable to the particular product and sale and Terex makes no other warranty, express or implied. Products and services listed may be trademarks, service marks or trade-names of Terex Corporation and/or its subsidiaries in the USA and other countries. All rights are reserved. Terex® is a registered trademark of Terex Corporation in the USA and many other countries.

Copyright Terex Cranes 2016



Terex Cranes
Global Marketing
Dinglerstraße 24 · 66482 Zweibrücken / Germany
Phone +49 (0) 6332 830
Email: info.cranes@terex.com

www.terex.com/cranes