

M1280D TOWER CRANE

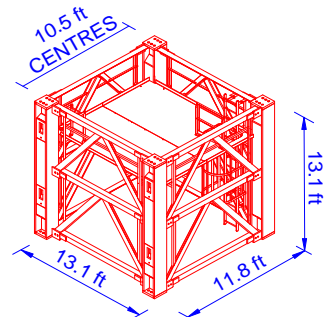
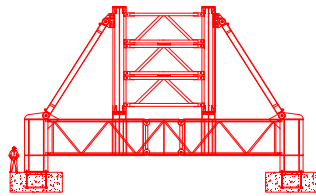
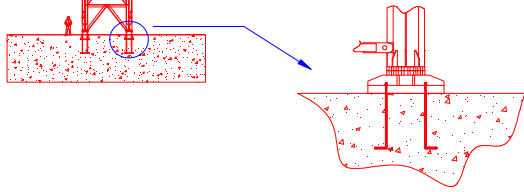

TYPICAL LOADS	
LOAD	RADIUS
165.3ton	57.1ft
110.2ton	82.0ft
77.7ton	110.0ft
53.6ton	150.0ft
31.8ton	200.0ft
13.5ton	265.0ft
AUX. HOIST	
LOAD	RADIUS
17.6ton	250.0ft
14.5ton	275.0ft

Technical Data Sheet

FAVELLE
FAVCO

M1280D RADIUS AND CAPACITY (SHORT TONS & FEET- WITH AUX. HOIST)



Boom Length	Max Rad. for Max WLL	Min Rad.	WLL at Min Rad.	1 FALL																	Max Rad.	WLL at Max Rad.			
				Radius(feet) & Capacity (tons)																					
(feet)	(feet)	(feet)	(ton)	30.0	50.0	70.0	90.0	110.0	130.0	140.0	150.0	160.0	170.0	180.0	190.0	200.0	210.0	220.0	230.0	240.0	250.0	260.0	(feet)	(ton)	
271.0	90.2	26.9	55.1	55.1	55.1	55.1	55.1	50.4	45.4	43.2	40.9	38.5	36.0	33.7	31.3	29.0	26.7	24.3	21.9	19.2	17.0	15.0	265.0	13.5	
240.8	131.2	24.6	55.1	55.1	55.1	55.1	55.1	55.1	55.1	54.0	49.5	45.5	41.9	38.5	35.1	31.8	27.7	24.8	22.9	-	-	-	-	235.0	21.2
210.6	140.0	22.0	55.1	55.1	55.1	55.1	55.1	55.1	55.1	55.1	55.1	53.6	46.6	42.5	37.7	34.2	30.0	-	-	-	-	-	205.0	29.2	
180.4	146.0	19.7	55.1	55.1	55.1	55.1	55.1	55.1	55.1	55.1	55.1	52.4	47.9	44.0	-	-	-	-	-	-	-	-	177.5	38.5	
150.2	147.6	17.4	55.1	55.1	55.1	55.1	55.1	55.1	55.1	55.1	-	-	-	-	-	-	-	-	-	-	-	-	148.5	51.0	
120.1	114.8	15.1	55.1	55.1	55.1	55.1	55.1	55.1	-	-	-	-	-	-	-	-	-	-	-	-	-	-	119.5	55.1	

Boom Length	Max Rad. for Max WLL	Min Rad.	WLL at Min Rad.	2 FALL																	Max Rad.	WLL at Max Rad.			
				Radius(feet) & Capacity (tons)																					
(feet)	(feet)	(feet)	(ton)	30.0	50.0	70.0	80.0	90.0	100.0	110.0	120.0	130.0	140.0	150.0	160.0	170.0	180.0	190.0	200.0	210.0	220.0	230.0	(feet)	(ton)	
240.8	82.0	24.6	88.2	88.2	88.2	88.2	88.2	83.1	78.5	73.5	65.8	59.1	53.2	49.3	45.5	42.6	37.6	34.2	31.2	27.8	24.1	22.0	235.0	20.3	
210.6	79.5	22.0	110.2	110.2	110.2	110.2	110.2	96.1	85.5	74.3	67.0	60.3	55.3	51.0	46.0	42.8	37.8	34.5	29.2	-	-	-	-	205.0	28.0
180.4	80.1	19.7	110.2	110.2	110.2	110.2	110.2	96.5	84.9	75.5	68.7	61.7	56.5	52.7	47.5	42.9	-	-	-	-	-	-	177.5	37.5	
150.2	80.7	17.4	110.2	110.2	110.2	110.2	110.2	100.4	88.6	77.7	69.5	62.1	55.1	-	-	-	-	-	-	-	-	-	-	148.5	50.0
120.1	82.0	15.1	110.2	110.2	110.2	110.2	110.2	98.1	88.5	75.0	-	-	-	-	-	-	-	-	-	-	-	-	119.5	65.0	

Boom Length	Max Rad. for Max WLL	Min Rad.	WLL at Min Rad.	3 FALL*																	Max Rad.	WLL at Max Rad.		
				Radius(feet) & Capacity (tons)																				
(feet)	(feet)	(feet)	(ton)	30.0	40.0	50.0	60.0	70.0	80.0	90.0	100.0	110.0	120.0	130.0	140.0	150.0	160.0	170.0	180.0	190.0	200.0	210.0	(feet)	(ton)
210.6	34.8	22.0	165.3	165.3	157.3	146.0	133.0	122.1	107.8	93.1	81.5	72.0	64.0	57.3	51.5	46.6	42.3	38.5	35.2	32.2	28.8	205.0	27.6	
180.4	55.1	19.7	165.3	165.3	165.3	164.9	153.6	128.5	109.6	94.8	83.2	73.7	65.8	59.0	53.3	48.4	44.2	40.4	-	-	-	-	177.5	36.9
150.2	56.4	17.4	165.3	165.3	165.3	165.1	155.2	130.1	111.2	96.4	84.8	75.4	67.4	60.7	54.5	-	-	-	-	-	-	-	148.5	49.4
120.1	57.1	15.1	165.3	165.3	165.3	165.3	157.2	132.1	113.2	98.4	86.8	74.0	-	-	-	-	-	-	-	-	-	-	119.5	63.7

* : 3 FALL CONFIGURATION OPTION IS REQUIRED FOR 3 FALL OPERATION

Boom Length	Max Rad. for Max WLL	Min Rad.	WLL at Min Rad.	AUXILIARY HOIST - 1 FALL																	Max Rad.	WLL at Max Rad.		
				Radius(feet) & Capacity (tons)																				
(feet)	(feet)	(feet)	(ton)	30.0	50.0	70.0	90.0	110.0	130.0	140.0	150.0	160.0	170.0	180.0	190.0	200.0	210.0	220.0	230.0	240.0	250.0	260.0	(feet)	(ton)
271.0	250.0	29.9	17.6	17.6	17.6	17.6	17.6	17.6	17.6	17.6	17.6	17.6	17.6	17.6	17.6	17.6	17.6	17.6	17.6	17.6	17.6	16.5	275.2	14.5
240.8	245.4	27.6	17.6	17.6	17.6	17.6	17.6	17.6	17.6	17.6	17.6	17.6	17.6	17.6	17.6	17.6	17.6	17.6	17.6	17.6	-	-	245.4	17.6
210.6	212.6	25.0	17.6	17.6	17.6	17.6	17.6	17.6	17.6	17.6	17.6	17.6	17.6	17.6	17.6	17.6	17.6	-	-	-	-	-	212.6	17.6
180.4	187.7	22.7	17.6	17.6	17.6	17.6	17.6	17.6	17.6	17.6	17.6	17.6	17.6	17.6	-	-	-	-	-	-	-	-	187.7	17.6
150.2	158.8	20.4	17.6	17.6	17.6	17.6	17.6	17.6	17.6	17.6	17.6	-	-	-	-	-	-	-	-	-	-	-	158.8	17.6
120.1	129.6	18.1	17.6	17.6	17.6	17.6	17.6	17.6	-	-	-	-	-	-	-	-	-	-	-	-	-	-	129.6	17.6

- NOTE:**
- ON REMOVAL OF FLY JIB AND FLY HOOK 1.1 TON EXTRA CAPACITIES ALLOWED AT ALL RADII
 - 1 SHORT TON = 2000 lbs

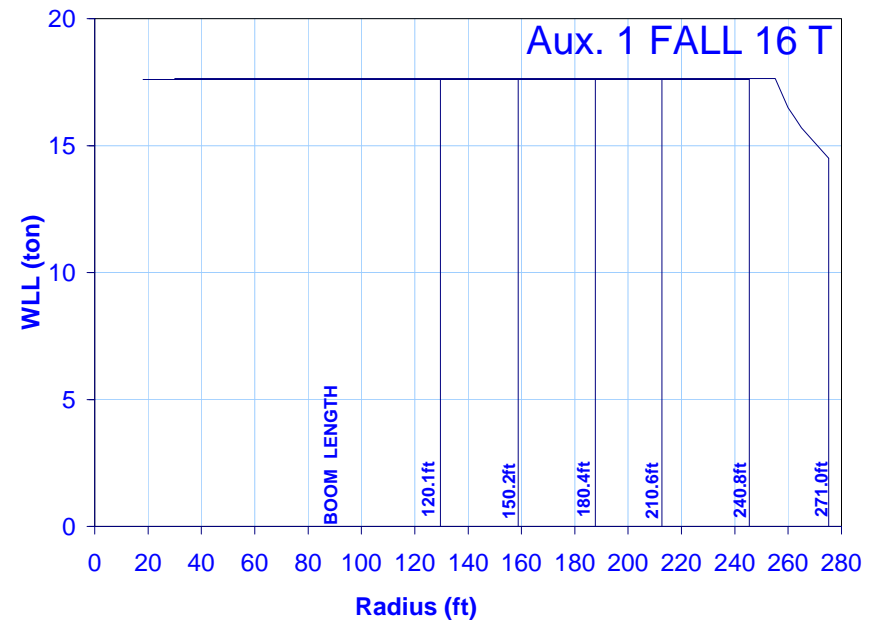
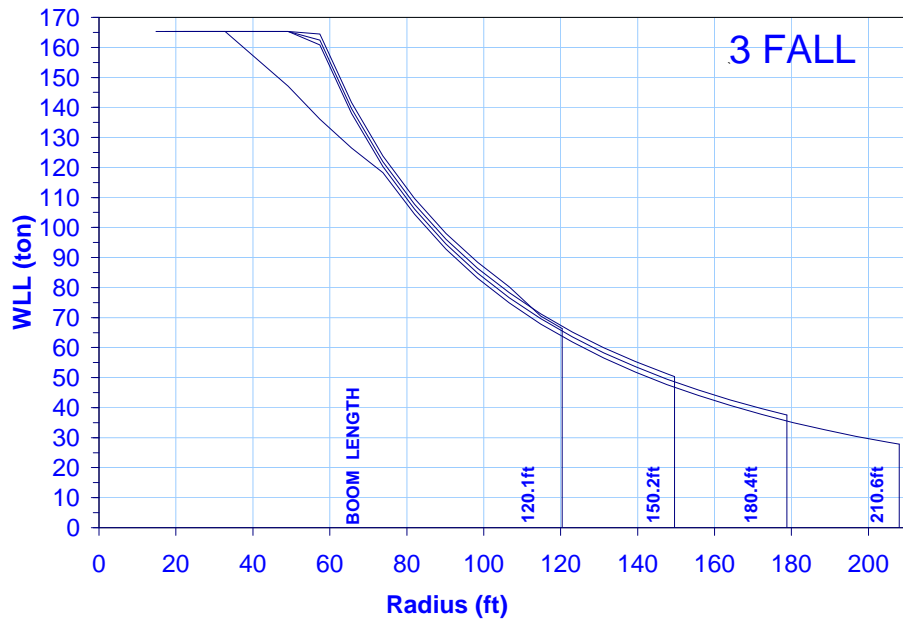
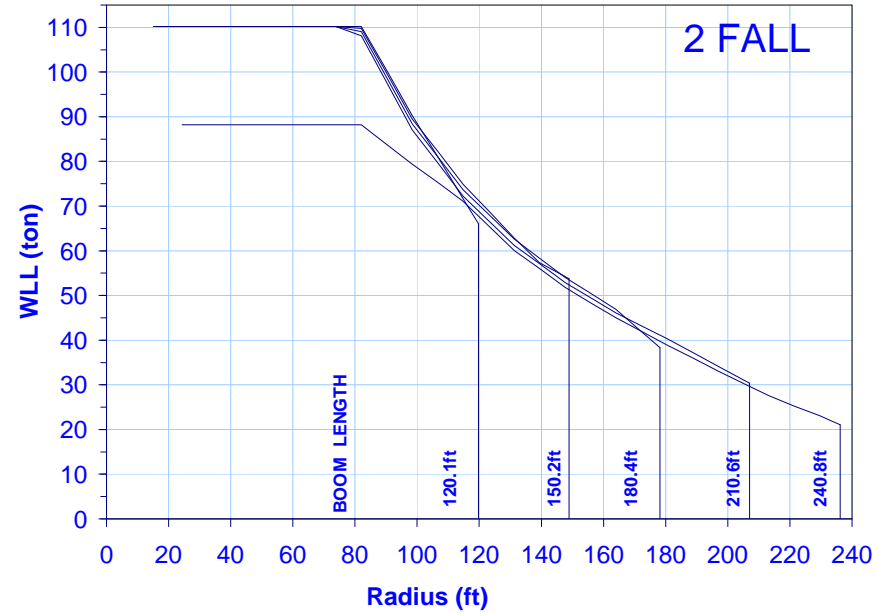
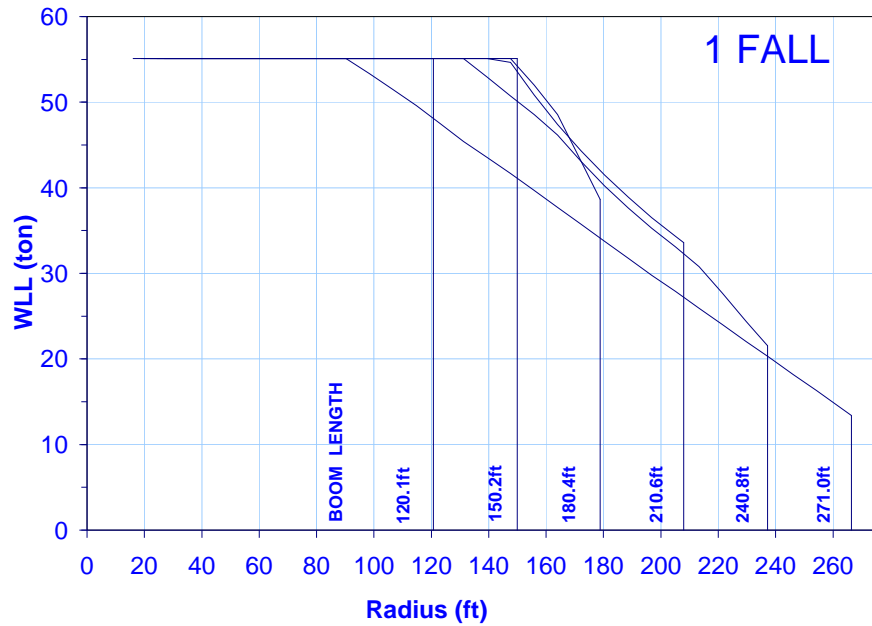

CRANE FREE-STANDING WITHOUT CLIMBING FRAME

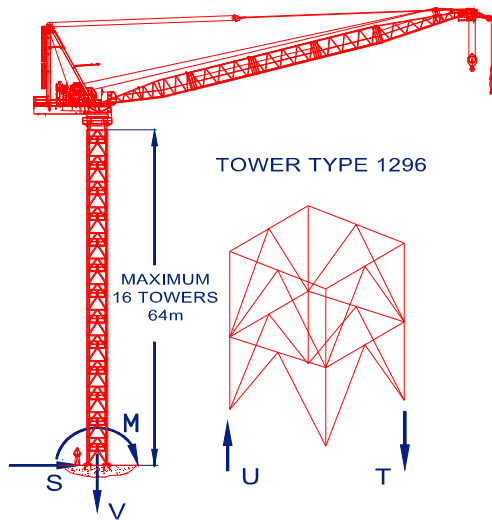

BUILDING REACTION

Design Load	I/S*	O/S†	O/S high ^	Unit
NO. of Towers	16	16	15	-
M	10029	6076	19323	ft ton
V	552	435	425	ton
S	13	56	130	ton
T	814	518	1408	ton
U	537	301	1195	ton
Ht _{Total}	210	210	197	ft

INTERNAL CLIMBER ON COLLARS

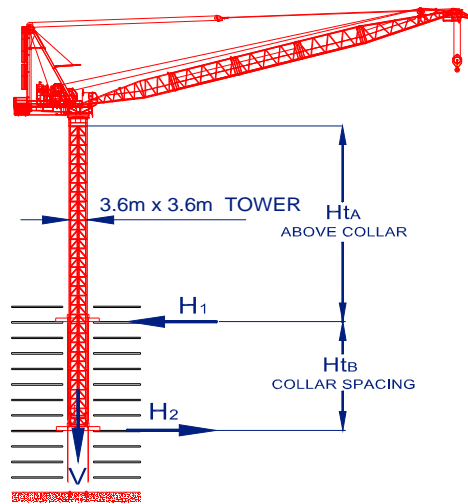

BUILDING REACTION

Design Load	I/S*	O/S†	O/S high^	Unit
NO. of Towers	16	16	15	-
V	558	441	431	ton
H ₁	163	97	311	ton
H ₂	152	49	202	ton
Ht _A	151	151	138	ft
Ht _B	59	59	59	ft
Ht _{Total}	210	210	197	ft

WITH CLIMBER- ONE TIE ABOVE THE BASE

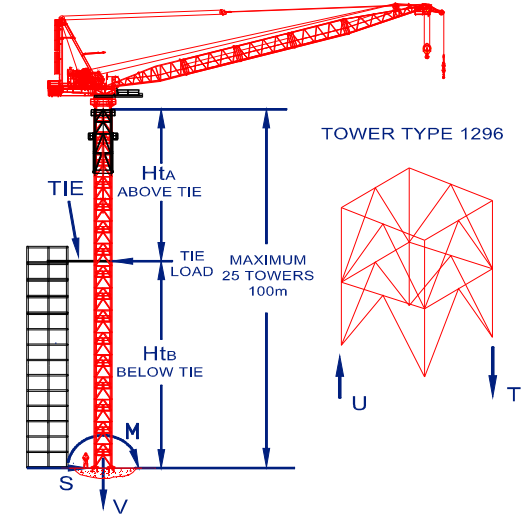

BUILDING REACTION

Design Load	I/S*	O/S†	O/S high^	Unit
NO. of Towers	25	25	23	-
TIE	100	94	277	ton
M	4795	2177	7613	ft ton
V	672	557	536	ton
S	88	40	151	ton
T	492	285	647	ton
U	155	8	379	ton
Ht _A	164	164	151	ft
Ht _B	164	164	151	ft
Ht _{Total}	328	328	302	ft

*:IN SERVICE WIND=65.6 ft/s

†:OUT OF SERVICE WIND= 137.8 ft/s

^:HIGH WIND (i.e. CYCLONE)= 213.3 ft/s

Notes:

- Structure is designed using permissible stress method. These loads will vary by change of boom length, height and type of tower, actual site wind conditions, no of falls and change of wind speed.
- To calculate alternative options for M1280D refer to Favelle Favco Design Sheet named "Crane Weight Wind Chart".

HOIST SPEED

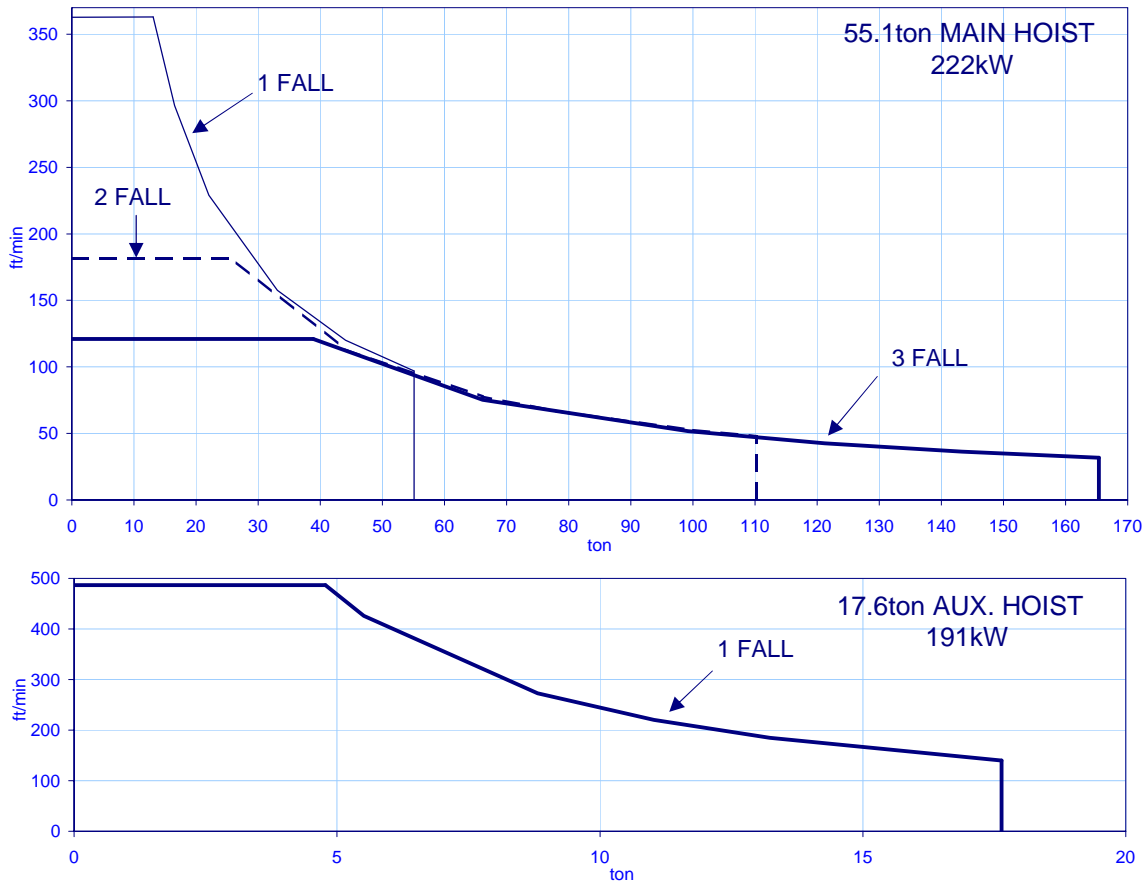

	LOAD (ton)	SPEED (ft/min)
1 FALL	13.1	363.0
	16.5	296.4
	22.0	229.0
	33.1	157.5
	44.1	120.0
2 FALL	55.1	96.9
	25.8	181.5
	44.1	113.2
	66.1	77.8
	77.2	67.3
3 FALL	99.2	53.0
	110.2	47.9
	38.9	121.0
	66.1	75.3
	99.2	51.6
AUX. (1 FALL)	121.3	42.7
	143.3	36.4
	165.3	31.7
	4.8	486.4
	5.5	426.1
	8.8	273.0
	11.0	220.2
	13.2	184.6
	17.6	140.1

LUFF&SLEW SPEEDS

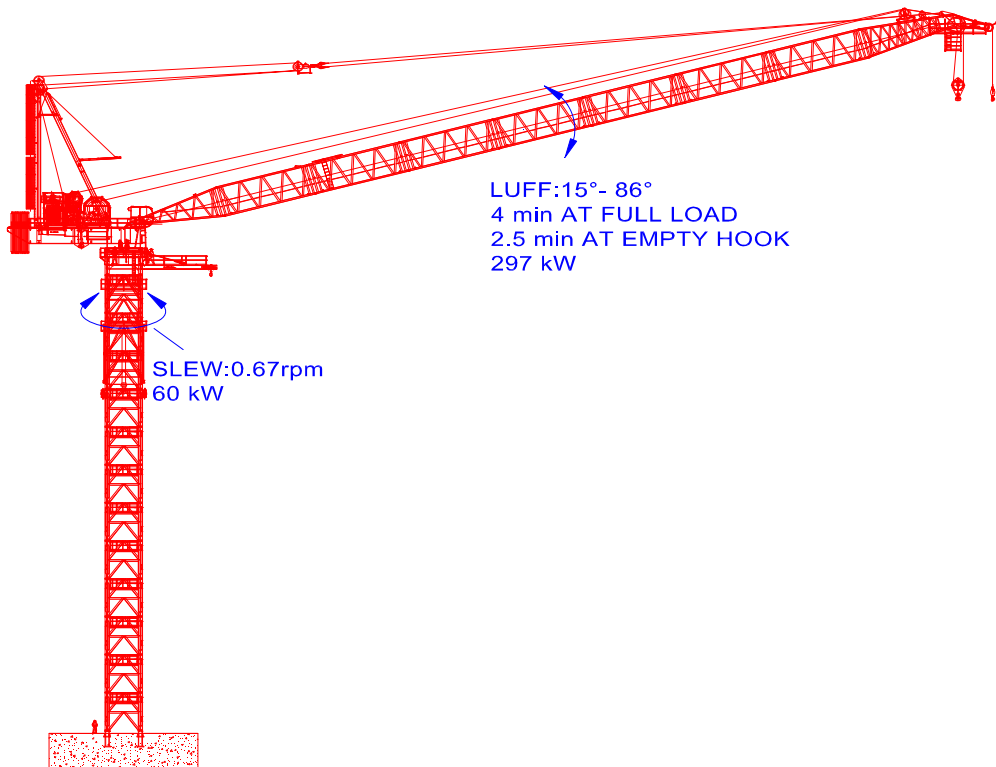

MACHINERY DECK ASSEMBLY

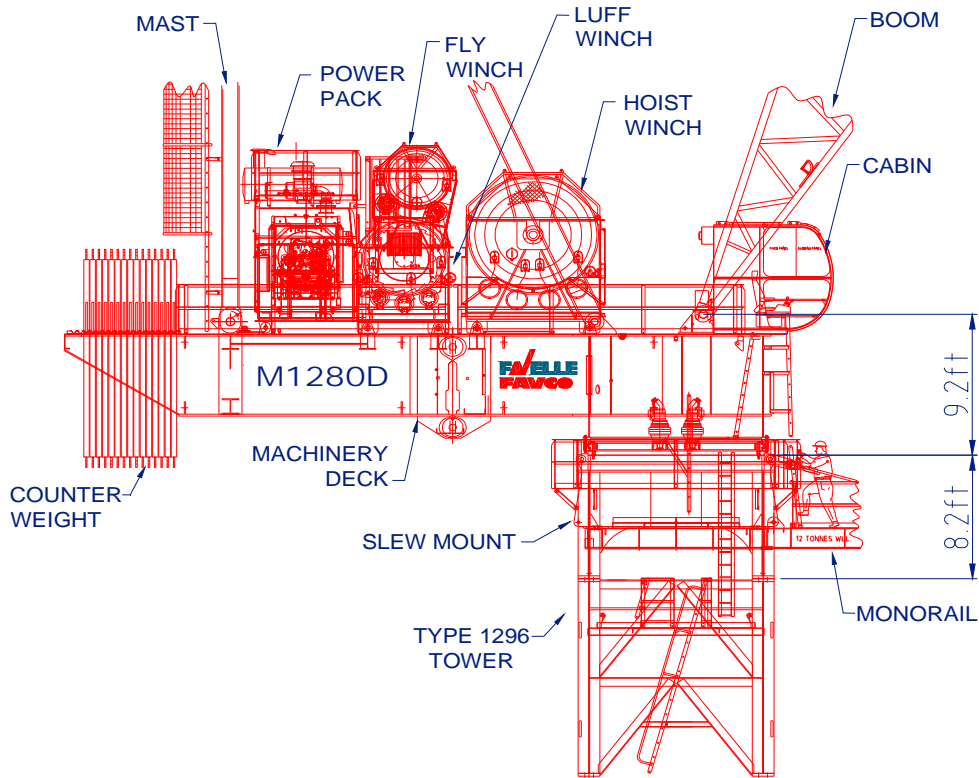

EXTERNAL CLIMBING INSTALLATION CLEARANCE

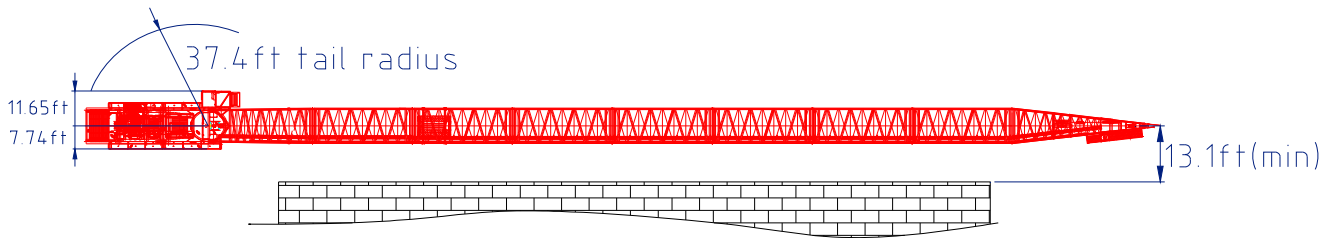











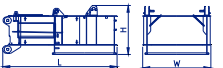
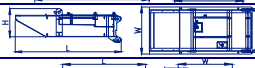
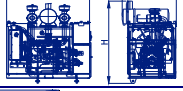

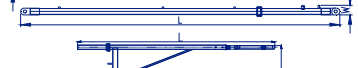

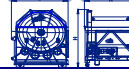
OUT OF SERVICE CONFIGURATION

Boom Length (ft)	Minimum weathervaning*	
	Radius (ft)	Angle (°)
271.0	65.6	76.3
240.8	73.8	72.6
210.6	83.7	67.1
180.4	95.1	58.8
150.2	113.2	42.1
120.1	114.8	22.5

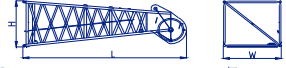
*: MINIMUM WEATHERVANING POSITION IS BASED ON A WIND SPEED OF 65.6 ft/s OR BOOM FLOAT AT 82.0 ft/s

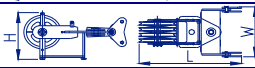
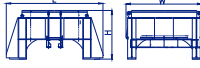
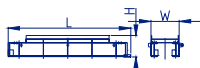
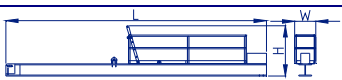
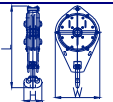
M1280D TRANSPORTATION & ERECTION

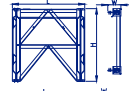
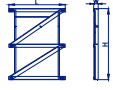

ITEM	QTY	DESCRIPTION	LENGTH L (feet)	HEIGHT H (feet)	WIDTH W (feet)	WEIGHT PER ITEM (lbs)	
1	1	SPLIT DECK-FRONT (INCL. SLEW DRIVE, PINS & HANDRAILS)		20.1	9.0	12.5	37934
2	1	SPLIT DECK-REAR		24.3	7.2	12.5	25221
3	1	POWERPACK (INCL. 850L OF OIL)		10.6	12.1	7.2	13431
4	2	MAST FRONT LEG		51.4	6.3	3.4	13427
	1	MAST HEAD		5.2	4.9	3.8	3354
	2	MAST BACK LEG		48.1	1.2	1.3	4510
	2	BUFFER (HALF PART)		19.5	0.7	5.8	759
		MAST ASSEMBLY (INC. SHEAVES, HEAD PIN, LADDERS, BUFFER AND PLATFORMS)					42375
5	1	CABIN & PLATFORM ASSEMBLY		11.6	12.8	5.9	5044
6	1	MAIN HOIST WINCH ASSY (EMPTY DRUM)		9.1	10.9	8.8	35894
7	1	AUX. HOIST WINCH ASSY (EMPTY DRUM)		6.0	6.8	5.3	8603
8	1	LUFF WINCH ASSY (EMPTY DRUM)		7.8	8.1	6.8	13135
9	1	BOOM BOTTOM 29.8ft (INC. WALKWAY&PINS)		30.6	10.5	12.3	5693
10	1	BOOM TOP 29.8ft (Without Fly) (INC. DEFLECTOR, SHEAVES & PINS) (PENDANT & PLATFORM)		33.3	10.6	12.3	14351
		BOOM TOP 29.8ft (With Fly) (INC. DEFLECTOR, SHEAVES & PINS) (PENDANT & PLATFORM)		41.5	10.6	12.3	16057
11	7	BOOM EXTENSION 31.2ft AND PENDANT BARS (BRIDLE PLATFORM 977 lbs)		30.6	10.5	12.3	7605 (8621)
14	1	BRIDLE		9.4	4.7	5.3	5881
15	1	SLEW MOUNT (INCL. PLATFORMS 1675lbs)		15.7	8.5	12.8	34644
	1	SLEW RING(INCL. BOLTS)		11.2	0.7		6459
	1	MONORAIL		11.3	2.1	3.5	2336
		Total					45177
16	1	EXTERNAL CLIMBER		38.5	6.6	14.8	73370
17	1	MONORAIL		24.0	6.8	3.4	7433
18	15	COUNTER WEIGHT		14.5	0.3	10.6	17265
19	1	HOOK - 3/2 FALL (165/110ton)		10.7	1.5	4.8	10318
20	1	HOOK - 1 FALL (17.6ton)		4.9	1.3	1.4	1133
21	2	MAIN PANEL		11.8	13.1	2.2	8966
	2	SIDE PANEL		9.2	12.9	0.7	1772
	1	DIAGONAL BRACE		12.7	0.5	0.5	243
		TOWER SECTION (INC. LADDER, HAND RAIL, PLATFORM)		11.8	13.1	12.3	22589
22	1	HOIST ROPE (Ø2.13inch) @9.51 lbs/ft			1312 ft		12977
23	1	FLY ROPE (Ø1.26inch) @ 3.33 lbs/ft			984 ft		3405
24	1	LUFF ROPE (Ø1.65inch) @ 5.75 lbs/ft			902 ft		5397