

Complies with ANSI B30.5

Rough Terrain Crane

60 ton (55 metric ton) lift capacity
112' main boom (34m)
33' - 56' jib (10 - 17m)



RT55

CONTENTS

2 FEATURES

3 KEY

4-6 TECHNICAL DESCRIPTION

7 CRANE WEIGHTS

8 CRANE DIMENSIONS

9 WORKING RANGE DIAGRAM

10-14 LOAD CHARTS

FEATURES



Formed boom made with high-yield steel which reduces the operating weight of the boom and maximizes performance.



We chose the Kessler Co. brand axle because they offer the most reliable product on the market and have years of experience in manufacturing mobile crane axles.



Full vision operator cab has been designed for maximum comfort and ease of operation.



The Dana 13.5HR 32662 transmission offers the latest technology for the diverse needs of off-road cranes.



The Cummins QSB 6.7 diesel engine is TIER-III compliant and is proven to have superior performance and durability.



Greer RCI 777 LMI (Load moment indicator) delivers the industry's most reliable electronic monitoring system available.





























STANDARD EQUIPMENT

- Formed boom
- Offsettable jib 0° - 20° - 40°
- Aux winch
- Winch camera
- Aux lifting sheave
- 60 ton hook block
- 6 ton hook ball
- Rotation resistant wire rope
- Deluxe tilt seat
- Air conditioner
- CAN-bus technology operating system
- Work light package: boom, cab and super structure
- Revolving amber light
- AM/FM radio
- Battery disconnect switch
- Front and rear lift lugs

ANSI & CE certified

KEY

	Counterweight		Boom angle
	Main boom		Telescoping mode
	Tip height		Working radius
	Boom with Jib		Distance from the hook to the head sheave pin
	Max. boom length with jib extension		Crane on tires
	Outrigger System (100%, 50%, 0% extended)		Crane with counterweight
	Operator cab		Swing
	Main and Auxiliary winches		Hook ball
	Hook block		Brakes
	Steering		Engine
	Load Moment Indicator (LMI)		Tires and wheels
	Transmission		Gradeability
	Hydraulic System		Winch camera
	Axles		

TECHNICAL DESCRIPTION

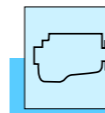

ENGINE

Cummins QSB 6.7 Inline 6 Cylinder Intercooled Turbo Diesel.
Horsepower Hp (kW) 215 (160) @ 2500 rpm.
Peak Torque ft lb (Nm) 655 (888) @ 1500 rpm.
80 Gallon Fuel Tank Capacity.

USA Federal EPA / California ARB / European EU / Tier III emission rating.

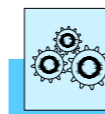

TRANSMISSION

Dana powershift (13.5HR 32662) Transmission - 6 speeds forward and 3 speeds reverse.
Front axle disconnect offering both 4x4 and 4x2 operation.
Max. Speed 24.2 mph (39Km).



AXLES

Kessler front and rear steering axles with planetary reduction.

Front - Rigid mount.

Rear - Full floating rear axle. Automatic rear axle oscillating lock occurs when superstructure is swung 10° from centerline in either direction.



STEERING

Power steering with three independent modes.
Front-Wheel 42 ft (12.7m) Min. steering radius.
All-Wheel 24 ft (7.5m) Min. steering radius.
Crab All-Wheel concentric steering.

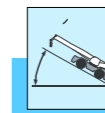

GRADEABILITY

144.7% Max. gradeability in 1st gear 4x4.
5.2% Max. gradeability in 6th gear 4x2.



BRAKES

Front and rear split system with air over hydraulic operation. 18.5" (470 mm) diameter disc brakes on all wheels.



TIRES AND WHEELS

26.5 x 25 - 32 ply rating, earthmoving style tires. Steel disc wheel.

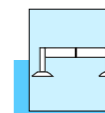

OUTRIGGER SYSTEM

Four independent horizontal beams and vertical jacks with integral holding valves, each independently controlled from operator cab.

100% - Full outrigger extension
footprint 512.5 sq. ft. (49.61 sq. m).

50% - Mid outrigger extension
footprint 358.7 sq. ft. (33.33 sq. m).

0% - Full outrigger retraction
footprint 205 sq. ft. (19 sq. m).

Light weight aluminum, quick release outrigger pontoons.

Floating ground bearing area 23.6" diameter (0.6m) (558 sq. in.) (0.36 sq. m).

Single outrigger jack extend and retract time 25 sec.

Single outrigger beam extend and retract time 6 sec.

TECHNICAL DESCRIPTION

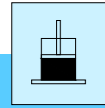

HYDRAULIC SYSTEM

PERMCO hydraulic pumps.
 67.88 gal/min (257 L/min) gear pump for main and auxiliary winches, boom hoist and telescope cylinders.
 17.7 gal/min (67 L/min) gear pump for steering.
 21.66 gal/min (82 L/min) gear pump for outriggers and slewing.
 184.88 gallon (700 L) hydraulic reservoir with external sight and temperature gauge.
 Easily accessible (10 micron) cartridge style full flow filters with bypass protection.
 Max./Min. ambient operating temperatures: +125° F / -20° F.
 Max. operating pressure: 27Mpa (4000 psi, 276 Bar).
 Combined pump capacity (GPM) 67.88 gal/min (257 L/min).



OPERATOR CAB

Full vision operator cab designed for max. comfort. All steel fabrication with acoustical lining and tinted safety glass throughout. The cab has a sliding door on the left and a sliding window on the right with a removable front windshield. Swing-up skylight with retractable shade and wiper motor. Fully adjustable deluxe seat with tilt. Foot controls for boom telescope, service brake and engine throttle. Tilt steering with column mounted gear shift controls.
 Temperature control is provided by a hydraulically driven air conditioning unit. Easy view dashboard with gauges for all engine sensors and rocker switch outrigger controls. Standard amenities also include bubble level, dome light, left side rearview mirror, seat belt, travel swing lock and signal horn.



COUNTERWEIGHT

Single 11000 lb (5000 Kg) counterweight.

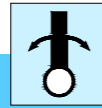

SWING

Bi-directional hydraulic swing drive with multi-disc wet brake and planetary reduction gearbox. Spring applied, hydraulically released swing brake and 360-degree pneumatic positive swing lock.
 Max. swing speed: 2.5 rpm.



LOAD MOMENT INDICATOR (LMI)

GREER RCI 777 LMI control system. Microguard graphic display load moment and anti-two block system with audio-visual warning and function limiter.

System displays the following information: Crane configuration, boom length, boom angle, load radius, allowed capacity, actual load, and load percentage of allowed capacity.

System includes settable work parameters: Min./Max. boom length, Min./Max. boom angle, defined swing area.



MAX. BOOM LENGTH WITH JIB EXTENSION

33 ft (10m) one-piece lattice type, side stowed, offsettable to 0°, 20° and 40°, with a fixed 23 ft (7m) pullout extension.
 Max. tip height with 33 ft (10m) jib erected is 153 ft (46.6m).
 Max. tip height with 33 ft (10m) jib + 23 ft (7m) fixed pullout extension is 175 ft (53.4m).

TECHNICAL DESCRIPTION

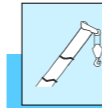

MAIN BOOM

Four section, full power, synchronized boom. Boom is constructed of high-yield steel. 5 sheave quick reeve boom tip with removable rope guards. Rope termination lugs on both sides of boom head. Auxiliary lifting sheave and manual angle indicator are included.

Fully extended boom length: 112 ft (34m).
 Fully retracted boom length: 35 ft (10.8m).
 Max. tip height, main boom: 120 ft (36.6m).
 Max. tip height, jib erected / pullout retracted: 153 ft (46.6m).
 Max. tip height, jib erected / pullout extended: 175 ft (53.4m).

Boom angle range (Min./Max.) -3° / + 78°.
 Boom raising / lowering time 56 sec. / 63 sec.
 Boom extension / retraction time ... 100 sec / 80 sec.

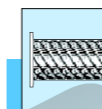

MAIN AND AUXILIARY WINCHES

Standard two speed main and auxiliary hoists, each with planetary reduction and spring applied multi-disk wet brake.
 Each hoist features:
 Grooved drum lagging.
 Hoist drum cable followers.
 Max. permissible line pull: 12125 lbs.
 Winch speed: 0 - 492 ft/min.
 Power up / power down.
 Electronic drum rotation indicators.

Rope construction: 35 x 7 rotation resistant compacted strand.
 Rope diameter: 0.75 in.
 Rope length: 607 ft.
 Min. breaking strength: 60625 lb.
 Max. rope storage: 607 ft.



WINCH CAMERA

Winch camera for viewing hoist operation.

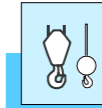

HOOK BLOCK AND HOOK BALL

60 Ton, 5 sheave (steel), standard reeve hook block with odd part pin-off and safety latch.
 Hook block weight 1433 lb (650kg).
 6 Ton top swivel hook ball with safety latch.
 Hook ball weight 265 lb (120kg).





REMARKS:

1. The crane operator manual must be available in the operator cab at all times.
2. The crane operator manual must be referred to prior to operation.
3. The lifting capacities shown are for lifting operation only.
4. Crane standing on firm, level ground.
5. Rated lifting capacities shown do not exceed 85% of the tipping load.
6. The weights of the hook block, hook ball and any additional lifting devices (rigging, hoisting rope, etc.) are not calculated into the rated lifting capacity and must be deducted prior to operation.
7. For max. wind speeds please refer to the lift chart in the operator manual.
8. Working radius is measured from center of swing to center of gravity of load.

WARNING: Operating this machine with heavier loads than the capacities listed is strictly prohibited.

CRANE WEIGHTS

CRANE OPERATING WEIGHTS						
Crane with cwt.	Gross Vehicle Weight		Front Axle Load		Rear Axle Load	
	lb	kg	lb	kg	lb	kg
	81291	36873	38261	17355	43030	19518

DEDUCTIONS FOR LOAD HANDLING						
	lb	kg	lb	kg	lb	kg
 Jib stowed aside boom	2099	952	3153	1430	-1054	-478
 Auxiliary head	121	55	194	88	-73	-33
 5 sheave 60 ton hook block	1433	650	2305	1045	-872	-395
 6 ton hook ball	265	120	425	193	-160	-73

TURNING RADIUS

Front Wheel (4x2) Steering	Imperial	Metric
Wall to wall over boom attached	51' 6.61"	15.7m
Wall to wall over carrier	43' 0.25"	13.1m
Curb to curb	41' 5.16"	12.6m
All Wheel (4x4) Steering	Imperial	Metric
Wall to wall over boom attached	36' 5.28"	11.1m
Wall to wall over carrier	26' 5.12"	8.1m
Curb to curb	24' 10.7"	7.3m
Tail Swing	Imperial	Metric
With counterweight	12' 4.8"	3.78m

CRANE DIMENSIONS

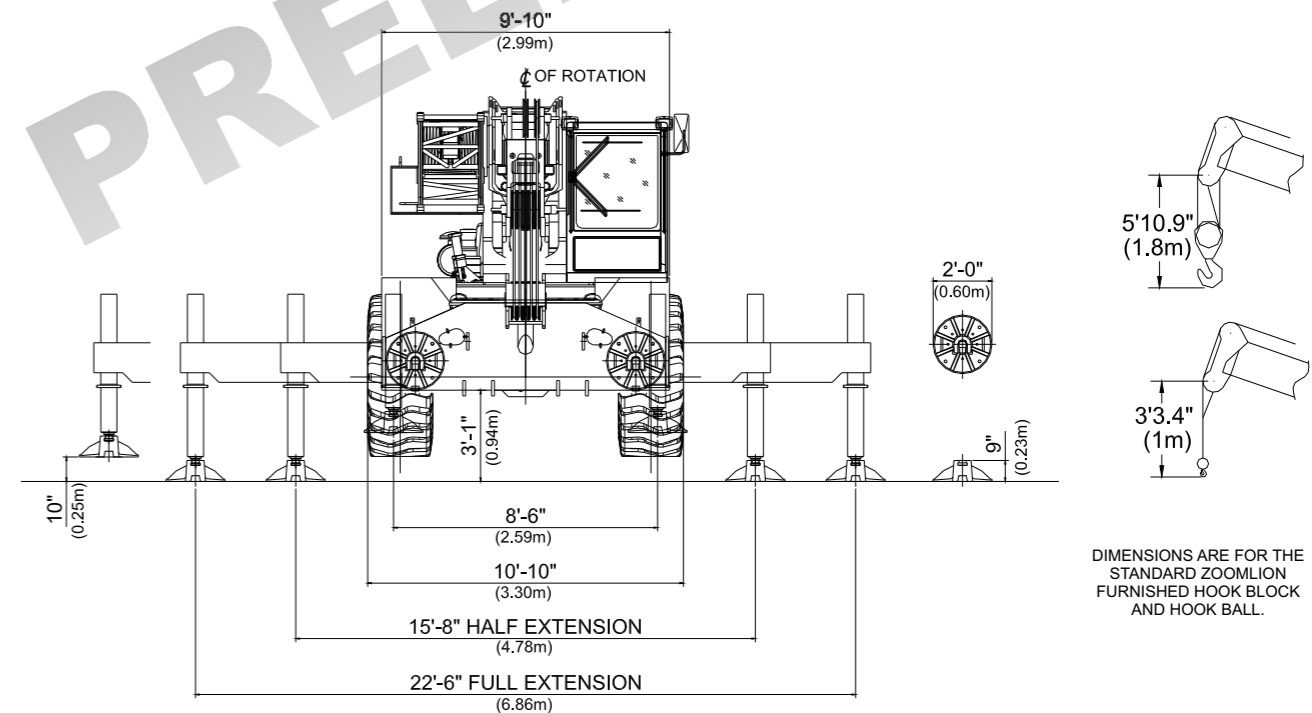
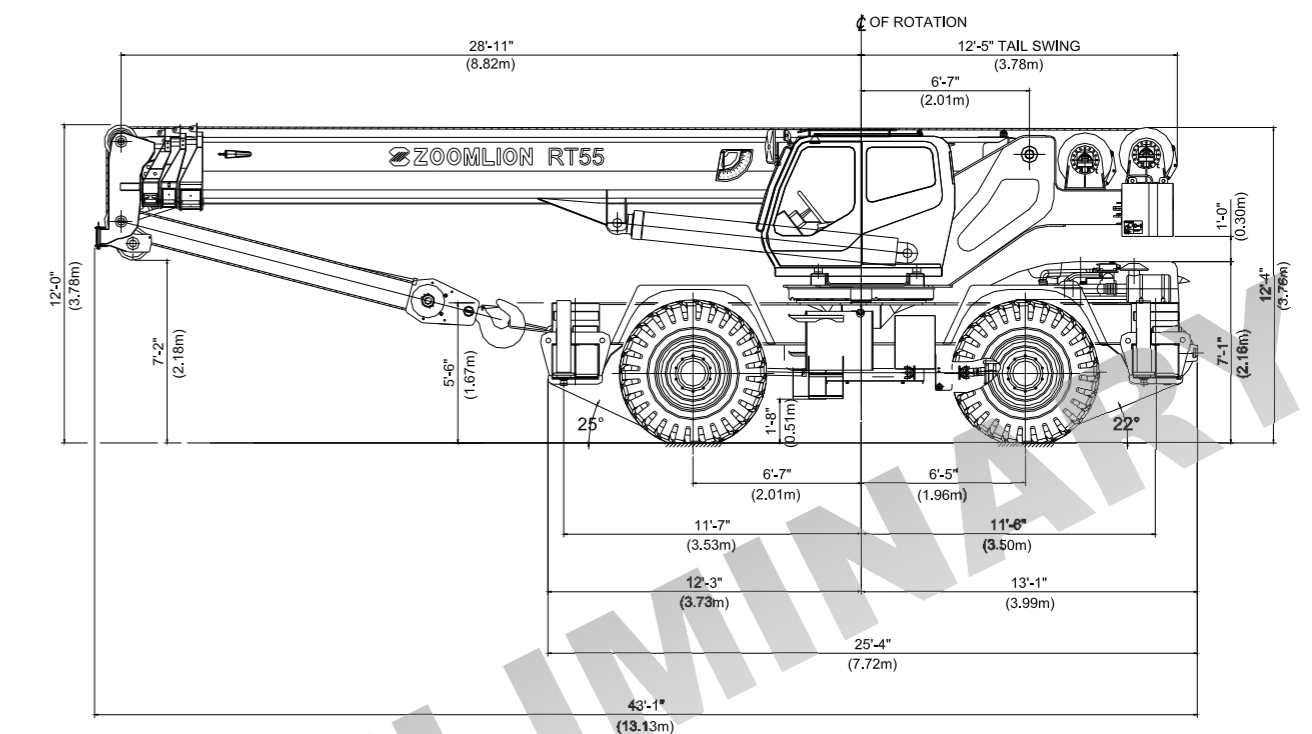

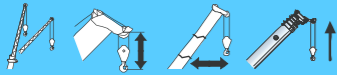

WORKING RANGE DIAGRAM

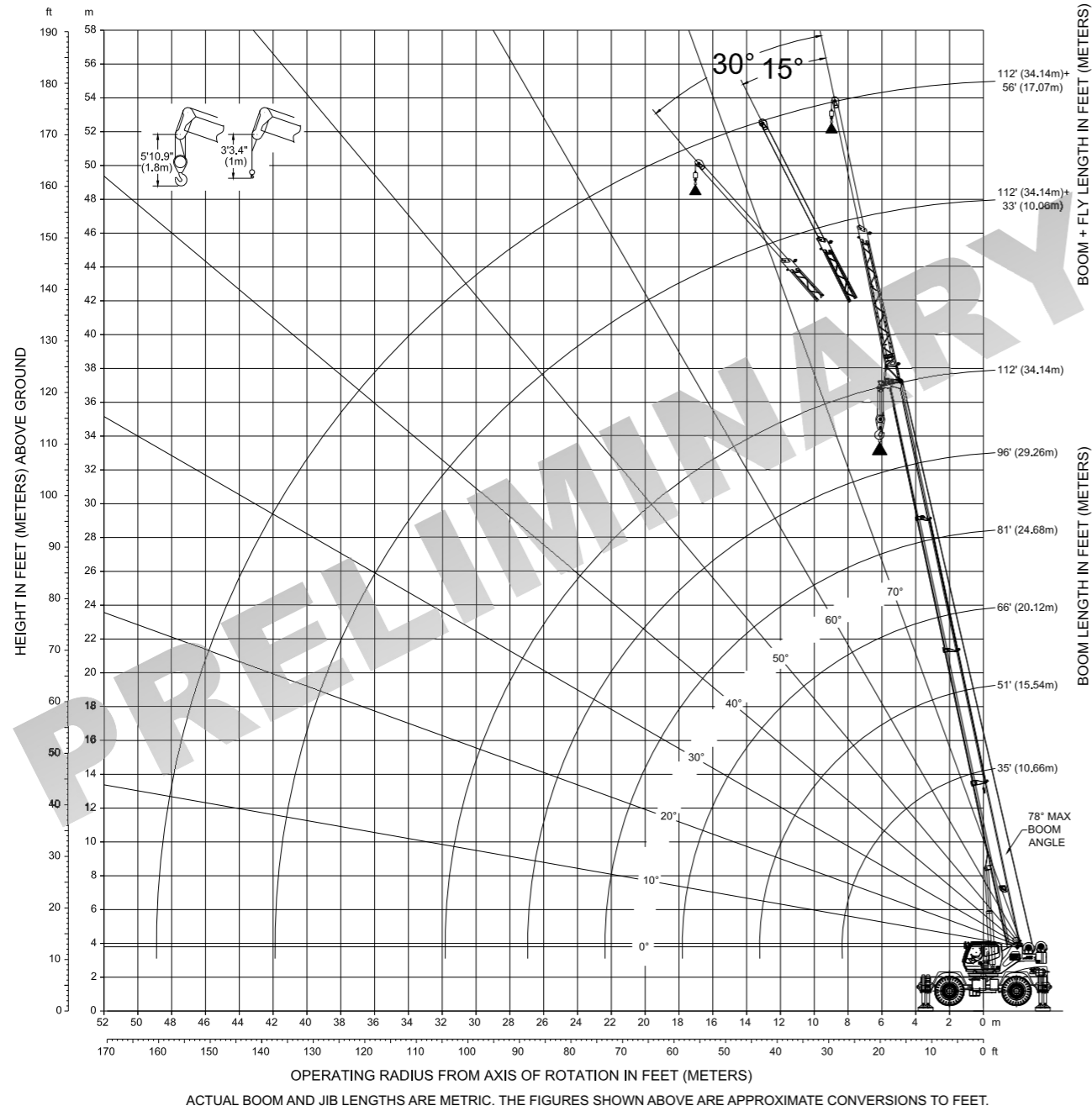

FULL EXTENSION OUTRIGGERS
 11000 lbs. cwt. 22.6 ft. x 22.6 ft. ANSI B30.5 85%

BOOM LENGTH FT.							
RADIUS	35 ft.	51 ft.	66 ft.	81 ft.	96 ft.	112 ft.	RADIUS
ft.							ft.
10	121000	60200					10
12	105930	60200	59460				12
15	87010	60200	59290	41580			15
20	65910	60200	52360	41580	31790	23280	20
25	52270	50930	44440	37400	31790	23280	25
30	37880	40730	38170	32230	28270	23280	30
35		30830	30080	28270	24750	21560	35
40		24360	24040	23200	21720	19030	40
45		20820	19720	19220	18170	17050	45
50			16490	16180	15410	14720	50
55			14020	13790	13220	12740	55
60			12600	11880	11430	11110	60
65				10320	9960	9740	65
70				9060	8720	8570	70
75				8330	7680	7570	75
80					6800	6700	80
85					6060	5950	85
90					5700	5280	90
95						4700	95
100						4210	100
105						3890	105

NOTES TO LIFTING CAPACITY

Rated lifting capacities shown do not exceed 85% of the tipping loads. The weight of the hook block, hook ball and any additional auxiliary lifting devices are not calculated into the rated lifting capacity and must be deducted prior to operation.

MID EXTENSION OUTRIGGERS							
11000 lbs. cwt.		15.8 ft. x 22.6 ft.		ANSI B30.5		85%	
BOOM LENGTH FT.							
RADIUS	35 ft.	51 ft.	66 ft.	81 ft.	96 ft.	112 ft.	RADIUS
ft.							ft.
10	95150	60200					10
12	81510	60200	59460				12
15	66440	60200	59460	46860			15
20	41800	42110	38840	35440	31470	23280	20
25	27520	28260	26930	25050	22720	20670	25
30	21370	20550	20030	19040	17470	16040	30
35		15670	15520	14990	13960	13010	35
40		12340	12360	12080	11380	10780	40
45		10500	10020	9900	9410	9020	45
50			8240	8200	7850	7610	50
55			6860	6850	6590	6460	55
60			6090	5750	5550	5500	60
65				4850	4690	4690	65
70				4110	3960	3980	70
75				3700	3340	3380	75
80					2820	2860	80
85					2390	2400	85
90					2190	1990	90
95							95
100							100
105							105

NOTES TO LIFTING CAPACITY

Rated lifting capacities shown do not exceed 85% of the tipping loads. The weight of the hook block, hook ball and any additional auxiliary lifting devices are not calculated into the rated lifting capacity and must be deducted prior to operation.

FULL RETRACTION OUTRIGGERS							
11000 lbs. cwt.		9 ft. x 22.6 ft.		ANSI B30.5		85%	
BOOM LENGTH FT.							
RADIUS	35 ft.	51 ft.	66 ft.	81 ft.	96 ft.	112 ft.	RADIUS
ft.							ft.
10	68290	60200					10
12	47990	46970	41930				12
15	32120	32300	29710	27030			15
20	19370	20100	19070	17860	16140	14830	20
25	12870	13720	13400	12730	11670	10870	25
30	9840	9810	9820	9530	8810	8270	30
35		7190	7350	7280	6810	6500	35
40		5330	5560	5600	5290	5160	40
45		4330	4200	4310	4110	4080	45
50			3150	3290	3160	3210	50
55			2340	2470	2390	2480	55

ON TIRES									
11000 lbs. cwt.		BOOM CENTERED OVER FRONT				ANSI B30.5		85%	
BOOM LENGTH FT.									
Stationary 0 mph					Creep 1.0 mph				
RADIUS	35 ft.	51 ft.	66 ft.	81 ft.	RADIUS	35 ft.	51 ft.	66 ft.	81 ft.
ft.	ft.	ft.	ft.	ft.	ft.	ft.	ft.	ft.	ft.
15	46900	46900			10	34960	34960		
20	31870	31870			12	26620	26620		
25	21250	21250			15	20590	20590		
30	15580	15580			20	14540	14540		
35	11070	11070			25	10610	10610		
40		8400	8400		30		7930	7930	
45		6780	6780		35		6400	6400	
50		4940	4940		40		4500	4500	
55			3770	3770	45			3360	3360
60			3090	3090	50			2730	2730
65			2030	2030	55			1660	1660

 11000 lbs. ctwt. FULL OUTRIGGERS 22.6 ft. x 22.6 ft. ANSI B30.5 85%						
112 FT. FULLY EXTENDED BOOM LENGTH						
33' OFFSETTABLE JIB						
BOOM ANGLE	RADIUS		RADIUS		RADIUS	
DEGREE	ft.	0°	ft.	20°	ft.	40°
78	23	12100	30	8360	36	5390
76	28	12100	35	7810	41	5170
74	33	12100	40	7370	46	5060
72	38	12100	44	7040	50	4950
70	42	11880	49	6710	55	4730
68	47	10560	54	6380	59	4620
66	52	9460	58	6050	63	4510
64	56	8580	63	5830	68	4400
62	61	7810	67	5610	72	4400
60	65	7020	71	5390	76	4290
58	69	6250	75	5280	80	4180
56	74	5590	79	5060	84	4070
54	78	5010	83	4590	87	4070
52	82	4500	87	4160	91	3960
50	86	4050	91	3770	94	3620
48	90	3660	94	3410	98	3290
46	93	3300	98	3100	101	3000
44	97	2990	101	2820	104	2740
42	100	2700	105	2560	107	2500
40	104	2460	108	2340	110	2280
38	107	2220	111	2130	113	2080

NOTES TO LIFTING CAPACITY

Rated lifting capacities shown do not exceed 85% of the tipping loads. The weight of the hook block, hook ball and any additional auxiliary lifting devices are not calculated into the rated lifting capacity and must be deducted prior to operation.

For on tires operation, boom must be centered over front of the crane, mechanical swing lock engaged and load restrained from swinging. On tires creep mode operation must not exceed 2.0 mph.

 11000 lbs. ctwt. FULL OUTRIGGERS 22.6 ft. x 22.6 ft. ANSI B30.5 85%						
112 FT. FULLY EXTENDED BOOM LENGTH						
56' OFFSETTABLE JIB						
BOOM ANGLE	RADIUS		RADIUS		RADIUS	
DEGREE	ft.	0°	ft.	20°	ft.	40°
78	28	8690	41	3740	52	2530
76	33	7700	46	3520	57	2420
74	39	6820	52	3410	62	2420
72	45	6160	57	3190	67	2310
70	50	5610	62	3080	72	2200
68	56	5170	67	2970	77	2200
66	61	4840	73	2860	82	2200
64	66	4510	78	2750	87	2090
62	71	4180	83	2640	91	2090
60	77	3960	87	2530	96	2090
58	82	3740	92	2420	100	1980
56	87	3520	97	2420	104	1980
54	91	3300	101	2310	108	1980
52	96	3190	106	2310	112	1980
50	100	3080	110	2200	116	1980
48	105	2860	114	2200	120	1870
46	109	2640	118	2090	123	1870
44	113	2380	121	1980	126	1760
42	117	2150	125	1870	130	1760
40	121	1930	128	1760	133	1650
38	125	1740	132	1620	135	1540

NOTES TO LIFTING CAPACITY

Rated lifting capacities shown do not exceed 85% of the tipping loads. The weight of the hook block, over haul ball and any additional auxiliary lifting devices are not calculated into the rated lifting capacity and must be deducted prior to operation.