



RT300 SERIES

Rough Terrain Cranes



FEATURES

- **30-35 tons (27-32 mt)**
maximum lifting capacity
- **94 ft. (28.6 m)**
maximum boom length
- **147 ft. (44.8 m)**
maximum tip height
- Four-section full power, mechanically synchronized boom with single lever control
- Swingaway jib offsettable 0°, 15° or 30°
- Two-speed main and auxiliary winches
- Quick-reeving boom head and hook block
- Fully independent multi-position out and down outriggers
- Environmental operator's cab optimizes load visibility and productivity
- RCI 510 load system Rated Capacity Indicator
- Easy access for routine servicing of the engine, transmission, batteries, etc. provided by hinged lockable access doors.
- Easy to read load chart books include range diagrams
- 12-month or 2000 hours warranty, major weldments are 5-years or 10,000 hours

**Simple, Available
and Cost Effective™**

Machines shown may have optional equipment.

TEREX RT 300 SERIES

Rough Terrain Cranes

RT 330 – 30 tons (27 mt)

RT 335 – 35 tons (32 mt)

94 ft. (28.6 m)

FOUR-SECTION, FULL-POWER, MECHANICALLY SYNCHRONIZED BOOM WITH SINGLE LEVER CONTROL

- High strength, four plate construction welded inside and out with embossed side plate holes to reduce weight and increase strength.
- Single boom hoist cylinder provides boom elevation of -5° to 76° for easier reeving changes and close radius operation.
- Quick-reeving boom head; no need to remove wedge from socket.
- 360° house lock standard

ENVIRONMENTAL OPERATOR'S CAB

- Rated Capacity Indicator (RCI) system including anti-two block system with automatic function disconnects.
- Deluxe six-way adjustable operator's seat has torsion bar suspension and adjustable head and arm rests.
- Sound and weather insulated for comfort.
- Removable front window, hinged tinted glass skylight, and sliding right-hand window.
- Dash-mounted controls for swing, boom telescope, boom hoist, and single lever two-speed main winch; pedals for swing brake and boom hoist. Foot accelerator with hand throttle.
- Complete instrumentation. Environmentally-sealed rocker switches. Circuit breakers in cab.

RUGGED, EASY-TO-MANEUVER CARRIER

- Box-type chassis construction with reinforcing cross members.
- Full power-shift transmission with integral torque converter; neutral start; 6 speeds forward 3 reverse.
- Hydraulic four-wheel power steering for 2-wheel, 4-wheel or crab steer.
- Full air brakes with air dryer.
- Fully independent hydraulic outriggers may be utilized fully extended to 22 ft. (6.71 m), in their 1/2 extended position, or fully retracted.
- Tail swing only 9 ft. (2.74 m).
- Standard Cummins 6BT5.9 diesel engine.
- Easy access for routine servicing of the engine, transmission, batteries, etc. is provided by hinged lockable access doors without the need to unbolt access panels.
- Engine compartment access doors (4), and operators cab are all keyed alike.
- All outside compartments and fluid reservoir access doors/caps have lockable latches or are equipped with padlock hasps.
- Standard 23.5R25 tires.
- Tachometer and rear axle centering light standard.



POWERFUL, TWO-SPEED WINCHES

- 533 fpm (162.5 m/min) maximum line speed, 15,639 lbs. (7093 kg) maximum line pull. Single lever control.
- Integral automatic brake.
- Electronic drum indicators.
- Grooved drum, tapered flanges, and spring loaded cable roller for improved spooling.

HIGH CAPACITY, DEPENDABLE HYDRAULIC SYSTEM

- Three gear pumps driven off the transmission. Combined system capability is 119 gpm (450 lpm).
- Hydraulic reservoir with 114 gal. (432 l) capacity and full flow oil filtration system.

OPTIONS INCLUDE:

- 32 ft. or 32 to 49 ft. (9.75 or 9.75 to 14.93 m) swing-on jib. Both offset 0°, 15° or 30°.
- Auxiliary winch with rope.
- Heater/defroster, air conditioner.
- Cold weather starting aid.
- 21:00 x 25, 28 P.R. tires.
- CAT 3116 DITA diesel engine.

For more information, product demonstration, or details on purchase, lease and rental plans, please contact your local Terex Cranes Distributor.

We reserve the right to amend these specifications at any time without notice. The only warranty applicable is our standard written warranty applicable to the particular product and sale. We make no other warranty, expressed or implied.



TEREX

TEREX Cranes
106 12th Street S.E.
Waverly, IA 50677-9466 USA
TEL: +1 (319) 352-3920
FAX: +1 (319) 352-5727
EMAIL: inquire@terexwaverly.com
WEB: terex.com



Notable Features | RT335-1



- ▶ Boom 94'
- ▶ Jib 32' or 32' to 49', offsettable
- ▶ Engine Cummins QSB5.9 215 hp
- ▶ Winch 533 fpm
Max Line Pull - 15,639 lb
- ▶ Pumps Gear Pumps (3)
Total GPM - 119
- ▶ Tires 23.5 x R25**



TEREX

Rough Terrain Crane Specifications | RT300-1 Series

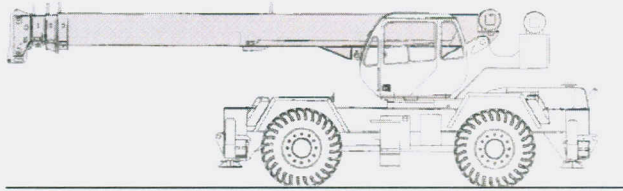

STANDARD BOOM EQUIPMENT

BOOM

30-94' (9.23-28.78 m), four section full power, mechanically synchronized boom. High-strength four plate construction with side plate holes. Anti-friction slide pads. Single boom hoist cylinder. Maximum tip height is 100' (30.48 m).

BOOM HEAD

Welded to fourth section of boom. Four or five load sheaves and two idler sheaves mounted on heavy duty, anti-friction bearings. Quick reeving boom head. Provisions made for side-stow jib mounting.

OPTIONAL BOOM EQUIPMENT

JIBS

32' (9.68 m) side stow swing-on one-piece lattice type jib. Single sheave mounted on anti-friction bearing. Jib is offsettable at 0°, 15°, or 30°. Maximum tip height is 129' (39.32 m) with 94' (28.49 m) boom.

32-49' (9.68 -14.86 m) side-stow swing-on lattice type jib. Single sheave mounted on anti-friction bearing. Jib is extendible to 49' (14.86 m) by means of a 17' (5.18m) manual pull-out tip section, roller supported for ease of extension. Jib is offsettable at 0°, 15°, or 30°. Maximum tip height is 147' (44.81 m) with 94' (28.49 m) boom.

AUXILIARY BOOM HEAD

Removable auxiliary boom head has single sheave mounted on anti-friction bearing. Removable pin-type rope guard for quick reeving. Installs on main boom peak only. Removal is not required for jib use.

HOOK BLOCK

Three or four metallic sheaves on anti-friction bearings with hook and heavy duty hook latch.

HOOK AND BALL

7.0 ton (6.3 mt) top swivel ball with hook and hook latch.



TEREX

ROUGH TERRAIN CRANE

RT300-1 SERIES

STANDARD UPPERSTRUCTURE EQUIPMENT

UPPERSTRUCTURE FRAME

All welded one-piece structure fabricated with high tensile strength alloy steel. Counterweight is removable.

TURNTABLE CONNECTION

Swing bearing is a single row, ball type, with external teeth. The swing bearing is bolted to both the revolving upperstructure and the carrier.

SWING

A hydraulic motor drives a double planetary reduction gear for precise and smooth swing function. Swing speed (no load) is 2.8 rpm.

SWING BRAKE

Heavy duty multiple disc swing brake is mechanically actuated from operator's cab by foot pedal. Brake may be locked on or used as a momentary brake.

RATED CAPACITY INDICATOR

Rated Capacity Indicator with visual and audible warning system and automatic function disconnects. Second generation pictographic display includes: boom radius, boom angle, boom length, allowable load, actual load, and percentage of allowable load registered by bar graph. Operator settable alarms provided for swing angle, boom length, boom angle, tip height, and work area exclusion zone. Anti-two block system includes audio/visual warning and automatic function disconnects.

OPERATORS CAB

Environmental cab with all steel construction, optimized visibility, tinted safety glass throughout, and rubber floor matting is mounted on vibration absorbing pads. The cab has a sliding door on the left side, framed sliding window on the right side, hinged tinted all glass skylight and removable front windshield to provide optimized visibility of the load open or closed. Acoustical foam padding insulates against sound and weather. The deluxe six-way adjustable operator's seat is equipped with a mechanical bar suspension and includes head and arm rests.

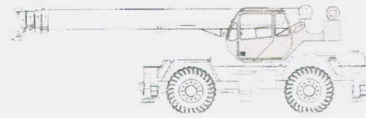

CONTROLS

All control levers and pedals are positioned for efficient operation. Armrest mounted dual axis controls for winch(s), swing, and boom elevation, winch rotation indication incorporated into control handles. Armrest swings up to improve access and egress. Vernier adjustable hand throttle included. Steering column mounted turn signal, wiper, and shift controls. Winches include ignition, engine stop, lights, horn, roof window wiper, hot air defroster, steering mode, parking brake, outriggers, 360° house lock. Horn and winch speed shift switches are mounted in the levers. Foot control pedals include swing brake, boom telescope, service brake and accelerator.

INSTRUMENTATION AND ACCESSORIES

In-cab gauges include air pressure, bubble level, engine oil pressure, fuel, engine temperature, voltmeter, transmission temperature and transmission oil pressure. Indicators include low air, high water temperature, low oil pressure, high transmission temperature and low coolant level audio/visual warning, hoist drum rotation indicator(s) and Rated Capacity Indicator. Accessories include fire extinguisher; light package including headlights, tail light, brake lights, directional signals, four-way hazard flashers, dome light and back-up lights with audible back-up alarm; windshield washer/wiper; skylight wipers; R.H. and L.H. rear view mirrors; dash lights; and seat belt. Circuit breakers protect electrical circuits.

HYDRAULIC CONTROL VALVES

Valves are mounted on the rear of the upperstructure and are easily accessible. Valves have electric/hydraulic operators and include one pressure compensated two spool valve for main and auxiliary winch and one single spool valve for swing. Quick disconnects are provided for ease of installation of pressure check gauges.

OPTIONAL EQUIPMENT

Auxiliary Winch, Heater/Defroster, hydraulically powered Air Conditioner with or without hydraulic heater, LP or Diesel Heater/Defroster, Tachometer, Work Lights, Rotating Beacon

STANDARD CARRIER EQUIPMENT

CARRIER CHASSIS

High strength chassis with four-wheel drive and four-wheel steer (4x4x4). Has box beam type construction with reinforcing cross members, a precision machined turn table mounting plate and integrally welded outrigger boxes. Decking has anti-skid surfaces, including tool storage compartment, and access steps and handles left and right side and front and rear corners.

AXLES AND SUSPENSION

Rear axle is a planetary drive/steer type with automatic oscillation lockouts that engage when the superstructure is swung 10° in either direction. Front axle is a planetary drive/steer type, rigid mounted to the frame for increased stability.

STEERING

Hydraulic four-wheel power steering for two-wheel, four-wheel, or crab steer is easily controlled by steering wheel.

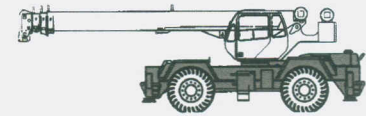

	23.5R25 tires	21.00x25 tires
Two-wheel:	36' 10.75" (11.25 m)	36' 8.7" (13.2 m)
Four-wheel:	20' 4.7" (6.22 m)	24' 7" (7.5 m)

TRANSMISSION

Range-shift type power-shift transmission with integral torque converter has neutral safety start, six speeds forward and six speeds reverse provides wide ration coverage. Automatic pulsating back-up alarm.



ROUGH TERRAIN CRANE RT300-1 SERIES

STANDARD CARRIER EQUIPMENT (CONTINUED)

MULTI-POSITION OUT AND DOWN OUTRIGGERS

Fully independent hydraulic outriggers may be utilized fully extended to 22'(6.71 m) centerline to centerline, in their 1/2 extended position, or fully retracted for maximum flexibility. Easily removable aluminum floats, each with an area of 452 in² (2 919 cm²), stow on the outrigger boxes at their point of use. Complete controls and a sight leveling bubble are located in the operator's cab.

WHEELS AND TIRES

Disc type wheels with full tapered bead seat rim. 150.50" (3.82 m) wheel-base.

TIRES

23.5R25** std., 21.00x25 28 PR opt.

HYDRAULIC SYSTEM

HYDRAULIC PUMPS

Three gear type pumps, one single and two in tandem, driven off the transmission. Combined system capability is 119 gpm (450 lpm). Includes pump disconnect.

Main and auxiliary winch pump

- ▶ 59.5 gpm (225.2 lpm) @ 3,500 psi (246.1 kg/cm²)

Boom Hoist and Telescope Pump

- ▶ 38.5 gpm (145.7 lpm) @ 3,500 psi (246.1 kg/cm²)

Power Steering, Outrigger and Swing Pump

- ▶ 21 gpm (79.5 lpm) @ 2,500 psi (175 kg/cm²)

MAIN WINCH SPECIFICATIONS

Hydraulic winch with bent axis piston motor and planetary reduction gearing provides 2-speed operation with equal speeds for power up and down. Winch is equipped with an integral automatic brake, grooved drum, tapered flanges, standard cable roller on drum, and electronic rotation indicator.

Performance	LO-Range	HI-Range
▶ Max line speed (no load)		
▶ First layer	184 fpm (56.1 m/min)	369 fpm (112.5 m/min)
▶ Fifth layer	266 fpm (81.1 m/min)	533 fpm (162.5 m/min)
▶ Max. line pull-first layer	15,639 lb (7 094 kg)	7,298 lb (3 310 kg)
▶ Max. line pull-fifth layer	10,827 lb (4 911 kg)	5,052 lb (2 292 kg)
▶ Permissible line pull	9,000 lb (4 082 kg)	

Drum Dimensions

- ▶ 10.62" (270 mm) drum diameter
- ▶ 17.55" (446 mm) length
- ▶ 18.0" (457 mm) flange dia.
- ▶ Cable: 5/8" x 450' (16 mm x 137.2 m)
- ▶ Cable type: 5/8" (16 mm) 6 x 19 IWRC XIPS, right regular lay, performed.

Drum Capacity

- Max. Storage: 570' (173.7 m)
- 6th layer is not a working layer
- Max. useable: 455' (138.7 m)*

*Based on minimum flange height above top layer to comply with ANSI B30.5

OPTIONAL AUXILIARY WINCH

Hydraulic 2-speed winch with bent axis piston motor, power up and down, equal speed, planetary reduction with integral automatic brake, grooved drum with tapered flanges, drum roller, and rotation indicator.

Performance (Same as main winch)

Drum Dimensions and Capacity (Same as main winch)

SERVICE BRAKES

Split system air over hydraulic brakes on all four wheels, 18" diameter disc single caliper brakes on front wheels and single caliper brakes on rear axle.

PARKING BRAKE

Front axle equipped with spring-set, air released emergency/parking brake.

OPTIONAL EQUIPMENT

Immersion Heater, Pintle Hook(s), Clearance Lights, Independent Rear Steering, Four Mode Rear Wheel Steer, 20,000 lb line pull front mounted winch.

FILTRATION

Full flow oil filtration system with bypass protection includes a removable 60 mesh (250 micron) suction screen-type filter and 5 micron replaceable return line filter.

HYDRAULIC RESERVOIR

All steel, welded construction with internal baffles and diffuser. Provides easy access to filters and is equipped with an external sight level gauge. The hydraulic tank is pressurized to aid in keeping out contaminants and in reducing potential pump cavitation. Capacity is 114 gal (432 liters). Hydraulic oil cooler is standard.

OPTIONAL HOIST LINE

Main winch and optional auxiliary winch-5/8' (16mm) rotation resistant compacted strand 18 x 19 or 19 x 19.
Min. breaking strength 22.6 tons (20.6 mt).

ENGINE SPECIFICATIONS

Make and Model	Cummins QSB5.9 (155 hp)
▶ Type	6 cylinder
▶ Bore and Stroke	4.02 x 4.72" (102x120 mm)
▶ Displacement	360 cubic inches (5.91)
▶ Rated HP	155 hp (116 kw) @ 2500 rpm
▶ Maximum HP	160 hp (119 kw) @ 2300 rpm
▶ Rated Torque	440 lb•ft (597 N•m) @ 1500 rpm
▶ Aspiration	turbocharged
▶ Air Filter	dry type
▶ Electrical System	12 volt
▶ Alternator	100 amp
▶ Battery	(2) 12V-1600 CCA
▶ Fuel Capacity	50 gal (189 L)

PERFORMANCE

Transmission Gear	Forward Drive	Max. Speed	Max. Tractive Effort	Gradeability @ Stall*
▶ 1	4-wheel	1.5 mph 2.4 km/h	78,999 lb 35,800 kg	240%
▶ 2	4-wheel	3.3 mph 5.3 km/h	38,900 lb 17,237 kg	66.8%
▶ 3	4-wheel	9.0 mph 14.5 km/h	13,900 lb 6,309 kg	19.4%
▶ 4	2-wheel	4.6 mph 7.4 km/h	27,165 lb 12,322 kg	42.5%
▶ 5	2-wheel	9.5 mph 15.3 km/h	13,029 lb 5,910 kg	18%
▶ 6	2-wheel	24.5 mph 39.4 km/h	4,768 lb 2,163 kg	5.2%

*All performance data is based on a gross vehicle weight of 81,000 lb (36 741 kg). 23.5x25 tires, 4x4 drive. Performance may vary due to engine performance. Gradeability data is theoretical and is limited by tire slip, machine stability, or oil pan design.



TEREX

GENERAL DIMENSIONS

- Dimensions given assume the boom is fully retracted in travel position and 23.5R25 tires. Add 3.0" (76 mm) for 21.00x25 tires.
- Minimum ground clearance under: transmission-21.62" (549 mm)
axle bowls-18.65" (474 mm)
- Approach and departure angles: 23.5R25 21.00x25
Approach angle (A): 22° 26°
Departure angle (B): 18° 21°

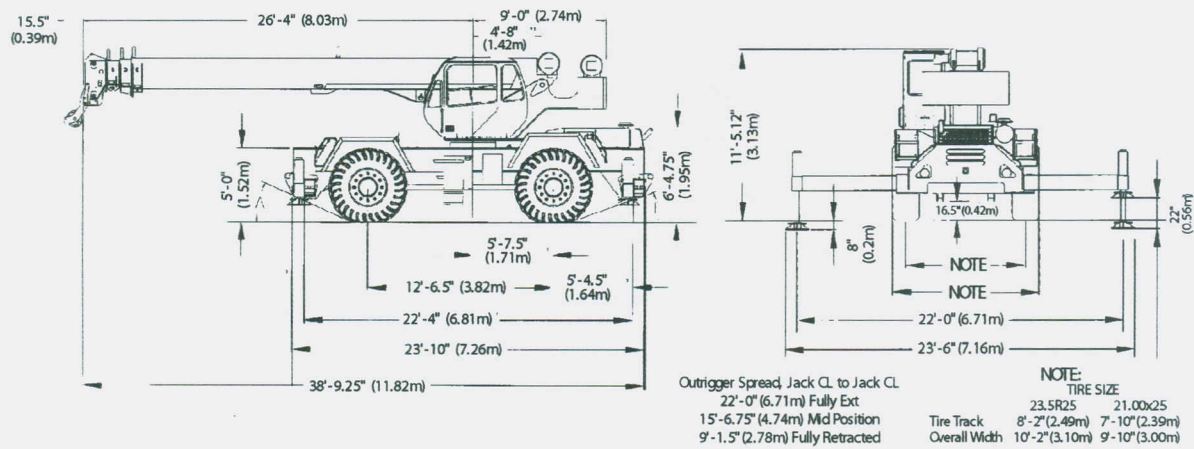

WEIGHTS & AXLE LOADS	GROSS WEIGHT LB	UPPER FACING FRONT		GROSS WEIGHT KG	UPPER FACING FRONT	
		FRONT	REAR		FRONT	REAR
Basic Crane with 10,000 lb (4536 kg) Counterweight	63,260	30,388	32,872	28,694	13,784	14,910
Add Options:						
32' (9.68 m) Swing-on jib (Stowed)	+ 1,368	+ 1,814	- 446	+ 621	+ 823	- 202
32'-49' (9.68 - 14.86 m) Swing-on Jib (Stowed)	+ 1,789	+ 2,147	- 358	+ 811	+ 974	- 163
Auxiliary Boom Head	+ 100	+ 260	- 160	+ 45	+ 118	- 73
Auxiliary Winch Controls and Plumbing Only	+ 75	+ 0	+ 75	+ 34	+ 0	+ 34
Auxiliary Winch with Wire Rope, Controls, Etc.	+ 264	- 56	+ 320	+ 120	- 25	+ 145
40T (36.3 mt) 4-Sheave Hook Block	+ 690	+ 1,017	- 327	+ 313	+ 461	- 148
30T (27.2 mt) 3-Sheave Hook Block	+ 670	+ 987	- 317	+ 304	+ 448	- 144
25T (22.7 mt) 2-Sheave Hook Block	+ 682	+ 1,005	- 323	+ 309	+ 456	- 147
6.25T Hook and Ball (In tool box)	+ 240	+ 261	- 21	+ 109	+ 118	- 9
Pintle Hook: Front	+ 45	+ 64	- 19	+ 20	+ 29	- 9
Rear	+ 45	- 22	+ 67	+ 20	- 10	+ 30
Substitute:						
450' (137.2 m) of 18x19 class spin resistant	+ 60	- 39	+ 99	+ 27	+ 18	+ 45

Note: Weights are for Terex supplied equipment and are subject to 2% variation due to manufacturing tolerances.

TEREX Cranes
 106-12th Street S.E.
 Waverly, Iowa 50677-9466 USA

TEL (319) 352-3920 FAX (319) 352-5727
 EMAIL inquire@terexwaverly.com
 WEB terex.com

WE RESERVE THE RIGHT TO AMEND THESE SPECIFICATIONS AT ANY TIME WITHOUT NOTICE. THE ONLY WARRANTY APPLICABLE IS OUR STANDARD WRITTEN WARRANTY APPLICABLE TO THE PARTICULAR PRODUCT AND SALE. WE MAKE NO OTHER WARRANTY, EXPRESSED OR IMPLIED.



Range Diagram and Lifting Capacity | RT335-1

35 TON LIFTING CAPACITY

RANGE DIAGRAM 30' - 94' BOOM



DIMENSIONS ARE FOR LARGEST FACTORY FURNISHED HOOK BLOCK AND HOOK & BALL, WITH ANTI-TWO BLOCK ACTIVATED

COUNTER WEIGHT	W/AUX. WINCH 8,900 LB W/O AUX. WINCH 10,000 LB
BOOM LENGTH	30'-94'
OUTRIGGER SPREAD	22'
STABILITY PERCENTAGE	ON OUTRIGGERS 85% ON TIRES 75%
PCSA CLASS	10-156

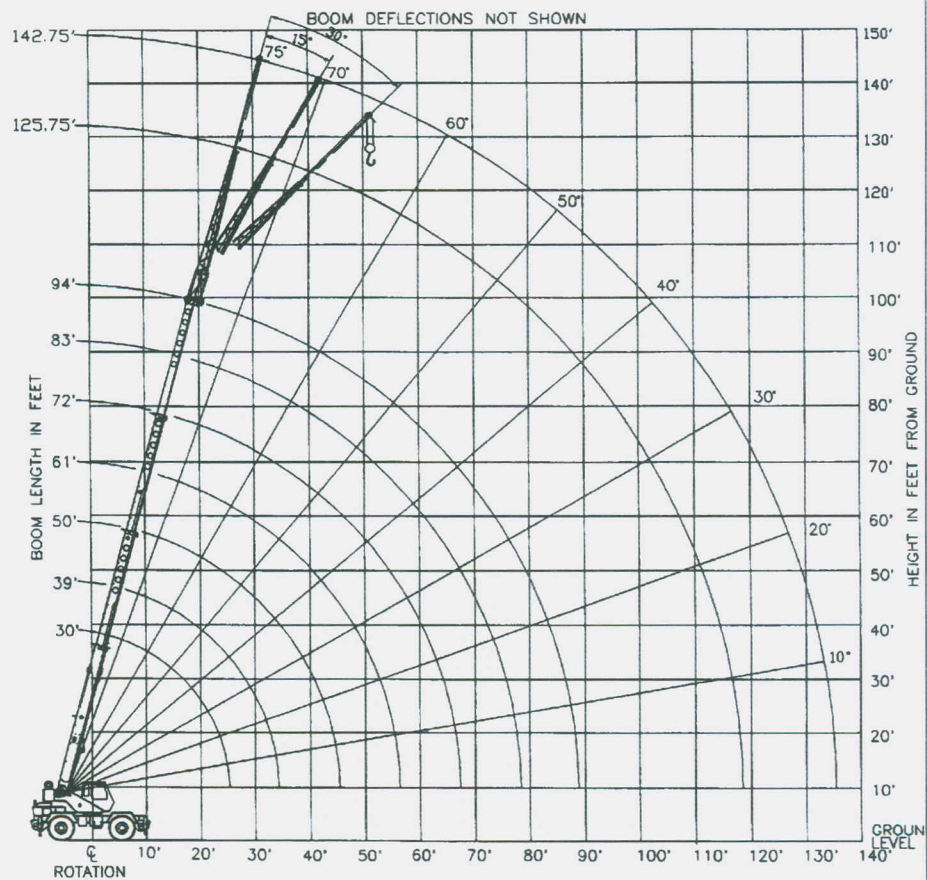

CRANE WORKING CONDITIONS

CRANE WORKING CONDITIONS

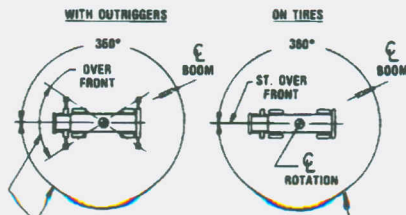

THESE LINES DETERMINE THE LIMITS OF WORKING POSITIONS WHICH CORRESPOND TO THOSE SHOWN ON THE CRANE CAPACITY CHART.

REDUCTION IN MAIN BOOM CAPACITY

All jib in stowed position	0 lb
Aux. boom in head sheave	100 lb

HOOK BLOCK WEIGHTS

Hook and ball	239 lb
Hook block (3 sheave)	670 lb
Hook block (4 sheave)	690 lb



ROUGH TERRAIN CRANE
RT335-1

LIFTING CAPACITIES CAUTION: Do not use this specification sheet as a load rating chart. The format of data is not consistent with the machine chart and may be subject to change

ON OUTRIGGERS - FULLY EXTENDED

LOAD RADIUS (FT)	BOOM LENGTH 30'			BOOM LENGTH 39'			BOOM LENGTH 50'			LOAD RADIUS (FT)
	LOADED BOOM ANGLE (DEG)	OVER FRONT (LB)	360° (LB)	LOADED BOOM ANGLE (DEG)	OVER FRONT (LB)	360° (LB)	LOADED BOOM ANGLE (DEG)	OVER FRONT (LS)	360° (LB)	
	10	63.0	70,000*	70,000*	69.4	46,600*	46,600*			
12	58.5	60,800*	60,800*	66.2	46,600*	46,600*	71.7	46,600*	46,600*	12
15	51.4	50,600*	50,600*	61.2	46,600*	46,600*	68.0	44,300*	44,300*	15
20	37.4	36,100*	36,100*	52.3	36,900*	36,900*	61.6	37,500*	37,500*	20
25	13.7	27,300*	27,300*	42.0	28,200*	28,200*	54.8	28,800*	28,800*	25
30	**			28.8	22,300*	22,300*	47.3	22,900*	22,900*	30
35				**			38.7	18,800*	18,800*	35
40							27.9	15,600*	15,600*	40
45							7.9	13,100*	13,100*	45
50							**			50
55										55
60										60
65										65
70										70
75										75
80										80
85										85
90										90

USE THESE CHARTS ONLY WHEN ALL OUTRIGGERS ARE FULLY EXTENDED

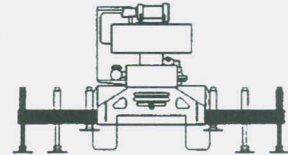

LOAD RADIUS (FT)	BOOM LENGTH 61'			BOOM LENGTH 72'			BOOM LENGTH 83'			BOOM LENGTH 52'			LOAD RADIUS (FT)
	LOADED BOOM ANGLE (DEG)	OVER FRONT (LB)	360° (LB)	LOADED BOOM ANGLE (DEG)	OVER FRONT (LB)	360° (LB)	LOADED BOOM ANGLE (DEG)	OVER FRONT (LB)	360° (LB)	LOADED BOOM ANGLE (DEG)	OVER FRONT (LB)	360° (LB)	
	10												
12													12
15	72.1	38,100*	38,100*										15
20	67.1	33,000*	33,000*	70.8	27,400*	27,400*							20
25	61.9	27,900*	27,900*	66.5	23,100*	23,100*	69.8	21,800*	21,800*	72.2	1,500*	17,500*	25
30	56.3	23,300*	23,300*	62.0	19,900*	19,900*	66.0	18,300*	18,300*	69.0	15,000*	15,000*	30
35	50.4	19,100*	19,100*	57.4	17,400*	17,400*	62.2	15,900*	15,900*	65.7	13,100*	13,100*	35
40	43.9	16,000*	16,000*	52.5	15,400*	15,400*	58.1	13,800*	13,800*	62.2	11,500*	11,500*	40
45	36.5	13,500*	13,500*	47.2	13,800*	13,800*	53.9	12,100*	12,100*	58.7	10,100*	10,100*	45
50	27.3	11,500*	11,500*	41.4	11,800*	11,800*	49.5	10,900*	10,900*	55.1	9,000*	9,000*	50
55	13.0	9,900*	9,900*	34.8	10,200*	10,200*	44.7	9,700*	9,700*	51.2	8,200*	8,200*	55
60	**			26.9	8,800*	8,800*	39.5	8,800*	8,800*	47.2	7,300*	7,300*	60
65				15.5	7,700*	7,700*	33.6	7,900*	7,800*	42.8	6,600*	6,600*	65
70				**			26.6	6,900*	6,800*	38.0	6,000*	6,000*	70
75							17.0	5,900*	5,800*	32.7	5,500*	5,500*	75
80							**			26.4	5,000*	5,000*	80
85										18.1	4,600*	4,500*	85
90										**			90

****MAXIMUM CAPACITY AT 0 DEGREE BOOM ANGLE**

BOOM LENGTH 30'			BOOM LENGTH 39'			BOOM LENGTH 50'			BOOM LENGTH 61'			BOOM LENGTH 72'			BOOM LENGTH 83'			BOOM LENGTH 94'		
LOAD RADIUS (FT)	OVER (LB)	360° (LB)	LOAD RADIUS (FT)	OVER (LB)	360° (LB)	LOAD RADIUS (FT)	OVER (LB)	360° (LB)	LOAD RADIUS (FT)	OVER (LB)	360° (LB)	LOAD RADIUS (FT)	OVER (LB)	360° (LB)	LOAD RADIUS (FT)	OVER (LB)	360° (LB)	LOAD RADIUS (FT)	OVER (LB)	360° (LB)
25.6	26,300	26,300	34.3	18,500	18,500	45.3	12,900	12,900	56.3	9,500	9,500	67.3	7,200	7,100	78.3	5,300	5,200	89.3	4,000	3,900

LIFTING CAPACITIES CAUTION: Do not use this specification sheet as a load rating chart. The format of data is not consistent with the machine chart and may be subject to change

ON OUTRIGGERS - MID POSITION

LOAD RADIUS (FT)	BOOM LENGTH 30'		BOOM LENGTH 39'		BOOM LENGTH 50'		LOAD RADIUS (FT)
	LOADED BOOM		LOADED BOOM		LOADED BOOM		
	ANGLE (DEG)	360° (LB)	ANGLE (DEG)	360° (LB)	ANGLE (DEG)	360° (LB)	
10	63.0	70,000*	69.4	46,600*			10
12	58.5	60,800*	66.2	46,600*	71.7	46,600*	12
15	51.4	50,600*	61.2	46,600*	68.0	44,300*	15
20	37.4	33,000	52.3	33,800	61.6	34,300	20
25	13.7	21,200	42.0	22,400	54.8	22,800	25
30	**		28.8	15,900	47.3	16,500	30
35			**		38.7	12,500	35
40					27.9	9,600	40
45					7.9	7,400	45
50					**		50
55							55
60							60
65							65
70							70
75							75
80							80
85							85
90							90

USE THESE CHARTS ONLY WHEN ALL OUTRIGGERS ARE PINNED IN MID POSITION

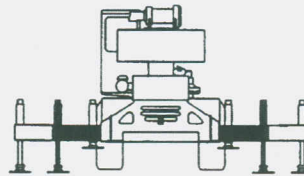

LOAD RADIUS (FT)	BOOM LENGTH 61'		BOOM LENGTH 72'		BOOM LENGTH 83'		BOOM LENGTH 94'		LOAD RADIUS (FT)
	LOADED BOOM		LOADED BOOM		LOADED BOOM		LOADED BOOM		
	ANGLE (DEG)	360° (LB)	ANGLE (DEG)	360° (LB)	ANGLE (DEG)	360° (LB)	ANGLE (DEG)	360° (LB)	
10									10
12									12
15	72.1	38,100*							15
20	67.1	33,000*	70.8	27,400*					20
25	61.9	23,100	66.5	23,100*	69.8	21,800*	72.2	17,500*	25
30	56.3	16,800	62.0	17,000	66.0	17,100	69.0	15,000*	30
35	50.4	12,800	57.4	12,900	62.2	13,100	65.7	13,100*	35
40	43.9	10,000	52.5	10,200	58.1	10,300	62.2	10,400	40
45	36.5	7,900	47.2	8,100	53.9	8,300	58.7	8,300	45
50	27.3	6,300	41.4	6,600	49.5	6,700	55.1	6,800	50
55	13.0	5,000	34.8	5,300	44.7	5,500	51.2	5,600	55
60	**		26.9	4,300	39.5	4,500	47.2	4,600	60
65			15.5	3,400	33.6	3,600	42.8	3,700	65
70			**		26.6	2,900	38.0	3,000	70
75					17.0	2,300	32.7	2,400	75
80					**		26.4	1,900	80
85							18.1	1,400	85
90							**		90

****MAXIMUM CAPACITY AT 0 DEGREE BOOM ANGLE**

BOOM LENGTH 30'		BOOM LENGTH 39'		BOOM LENGTH 50'		BOOM LENGTH 61'		BOOM LENGTH 72'		BOOM LENGTH 83'		BOOM LENGTH 94'	
LOAD RADIUS (FT)	360° (LB)	LOAD RADIUS (FT)	360° (LB)	LOAD RADIUS (FT)	360° (LB)	LOAD RADIUS (FT)	360° (LB)	LOAD RADIUS (FT)	360° (LB)	LOAD RADIUS (FT)	360° (LB)	LOAD RADIUS (FT)	360° (LB)
25.6	20,100	34.3	12,100	45.3	7,300	56.3	4,700	67.3	3,000	78.3	1,900	89.3	1,000



ROUGH TERRAIN CRANE

RT335-1

LIFTING CAPACITIES CAUTION: Do not use this specification sheet as a load rating chart. The format of data is not consistent with the machine chart and may be subject to change

ON OUTRIGGERS - RETRACTED

LOAD RADIUS (FT)	BOOM LENGTH 30'		BOOM LENGTH 39'		BOOM LENGTH 50'		LOAD RADIUS (FT)
	LOADED BOOM		LOADED BOOM		LOADED BOOM		
	ANGLE (DEG)	360° (LB)	ANGLE (DEG)	360° (LB)	ANGLE (DEG)	360° (LB)	
10	63.0	51,000	69.4	46,600*			10
12	58.5	35,800	66.2	36,500	71.7	37,100	12
15	51.4	23,800	61.2	24,500	68.0	25,000	15
20	37.4	14,000	52.3	14,800	61.6	15,300	20
25	13.7	8,800	42.0	9,800	54.8	10,400	25
30	**		28.8	6,700	47.3	7,300	30
35			**		38.7	5,200	35
40					27.9	3,700	40
45					7.9	2,400	45
50					**		50
55							55
60							60

USE THESE CHARTS WHEN ALL OUTRIGGER BEAMS ARE NOT IN EITHER THE MID OR FULLY EXTENDED POSITION

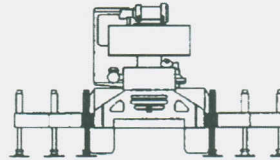

LOAD RADIUS (FT)	BOOM LENGTH 61'		BOOM LENGTH 72'		BOOM LENGTH 83'		BOOM LENGTH 94'		LOAD RADIUS (FT)
	LOADED BOOM		LOADED BOOM		LOADED BOOM		LOADED BOOM		
	ANGLE (DEG)	360° (LB)	ANGLE (DEG)	360° (LB)	ANGLE (DEG)	360° (LB)	ANGLE (DEG)	360° (LB)	
10									10
12									12
15	72.1	25,300							15
20	67.1	15,600	70.8	15,800					20
25	61.9	10,600	66.5	10,800	69.8	10,900	72.2	11,000	25
30	56.3	7,600	62.0	7,800	66.0	7,900	69.0	8,000	30
35	50.4	5,500	57.4	5,700	62.2	5,800	65.7	5,900	35
40	43.9	4,000	52.5	4,200	58.1	4,400	62.2	4,500	40
45	36.5	2,900	47.2	3,100	53.9	3,300	58.7	3,400	45
50	27.3	2,000	41.4	2,200	49.5	2,400	55.1	2,500	50
55	13.0	1,200	34.8	1,500	44.7	1,700	51.2	1,800	55
60	**		26.9	900	39.5	1,100	47.2	1,200	60

****MAXIMUM CAPACITY AT 0 DEGREE BOOM ANGLE**

BOOM LENGTH 30'	BOOM LENGTH 39'	BOOM LENGTH 50'	BOOM LENGTH 61'	BOOM LENGTH 72'	BOOM LENGTH 83'	BOOM LENGTH 94'	
LOAD RADIUS (FT)	360° (LB)	LOAD RADIUS (FT)	360° (LB)	LOAD RADIUS (FT)	360° (LB)	LOAD RADIUS (FT)	360° (LB)
25.6	8,200	34.3	4,700	45.3	2,300	56.3	1,000



LIFTING CAPACITIES CAUTION: Do not use this specification sheet as a load rating chart. The format of data is not consistent with the machine chart and may be subject to change

SIDE STOW JIB ON FULLY EXTENDED OUTRIGGERS

LOADED BOOM ANGLE (DEG)	26' OFFSETTABLE JIB/NO PULL OUT INSTALLED						43' OFFSETTABLE JIB/PULL OUT RETRACTED						LOADED BOOM ANGLE (DEG)
	0° OFFSET		15° OFFSET		30° OFFSET		0° OFFSET		15° OFFSET		30° OFFSET		
	LOAD RADIUS (REI) (FT)	LOAD (LB)	LOAD RADIUS (REI) (FT)	LOAD (LB)	LOAD RADIUS (REI) (FT)	LOAD (LB)	LOAD RADIUS (REI) (FT)	LOAD (LB)	LOAD RADIUS (REI) (FT)	LOAD (LB)	LOAD RADIUS (REI) (FT)	LOAD (LB)	
75	38	9,100*	46	7,700*	52	5,900*	41	5,100*	55	3,400*	62	2,700*	75
73	42	8,600*	49	7,300*	55	5,800*	47	4,800*	59	3,300*	68	2,700*	73
71	45	8,200*	52	7,000*	58	5,600*	52	4,500*	64	3,200*	73	2,600*	71
68	50	7,800*	58	6,200*	63	5,100*	60	4,100*	70	3,000*	79	2,500*	68
65	56	6,700*	63	5,500*	68	4,600*	66	3,800*	76	2,900*	84	2,500*	65
62	61	5,900*	68	4,900*	73	4,200*	71	3,600*	81	2,800*	88	2,400*	62
59	66	5,200*	73	4,400*	77	3,800*	77	3,400*	86	2,700*	93	2,400*	59
55	73	4,400*	79	3,900*	83	3,400*	84	3,100*	93	2,600*	99	2,300*	55
51	79	3,800*	85	3,400*	88	3,100*	91	2,900*	99	2,500*	105	2,300*	51
47	86	3,300*	91	3,000*	94	2,800*	100	2,800*	106	2,400*	110	2,200*	47
43	92	2,900*	97	2,700*	99	2,500*	109	2,400*	112	2,200*	116	2,000*	43
38	100	2,400*	103	2,300*	105	2,200*	116	2,100*	119	1,900*	122	1,800*	38
32	106	2,100*	109	2,000*	110	1,900*	122	1,800*	126	1,600*	127	1,500*	32
25	113	1,700*	114	1,700*			129	1,500*	131	1,400*			25
17	118	1,500*	118	1,500*			133	1,300*	135	1,200*			17
0	121	1,200*					138	1,000*					0

Notes For Jib Capacities:

- A. For all boom lengths less than the maximum with a jib erected, the rated loads are determined by boom angle only in the appropriate column.
- B. For boom angle not shown, use the capacity of the next lower boom angle.
- C. Listed radii are for extended main boom only.

ON TIRES

RADIUS (FT)	BOOM LENGTH (FT)	23.5R25**				21.00 X 25-28PR			
		PICK & CARRY				PICK & CARRY			
		STATIONARY		CREEP		STATIONARY		CREEP	
10	30	30,900	46,700*	39,000*	30,500	56,000*	47,400*		
12	30	24,900	40,600*	33,800*	25,400	48,900*	41,200*		
15	39	19,100	33,600*	27,800*	18,900	40,700*	34,100*		
20	39	12,400	24,600	20,900*	11,600	24,900	24,900		
25	50	8,400	16,400	16,100	7,600	16,500	16,500		
30	50	5,600	12,500	12,500	5,200	12,600	12,600		
35	50	4,300	9,600	9,600	3,900	9,600	9,600		
40	61	3,000	7,500	7,500	2,800	7,600	7,600		
45	61	2,300	6,100	6,100	2,100	6,200	6,200		
50	61	1,600	5,000	5,000	1,400	5,200	5,200		
55	61		4,300	4,300		4,300	4,300		
60	72		3,500	3,500		3,600	3,600		
65	72		2,800	2,800		2,800	2,800		
70	83		2,200	2,200		2,200	2,200		
75	83		1,800	1,800		1,900	1,900		
80	94		1,500	1,500		1,500	1,500		

Notes For On Tire Capacities:

- A. For Pick and Carry operations, boom must be centered over the front of the crane with swing brake and lock engaged. Use minimum boom point height and keep load close to ground surface.
- B. The load should be restrained from swinging. NO ON TIRE OPERATION WITH JIB ERRECTED.
- C. Without outriggers, never maneuver the boom beyond listed load radii for applicable tires to ensure stability.
- D. Creep speed is crane movement of less than 200' (61m) in a 30 minute period and not exceeding 1.0 mph (1.6 km/h).
- E. Refer General Notes for additional information.

RECOMMENDED TIRE PRESSURE

TIRE SIZE	STATIONARY	CREEP	2 1/2 MPH	TRAVEL
23.5R25**	24 PSI	94 PSI	94 PSI	76 PSI
21.00 x 25-28 PR	85 PSI	85 PSI	85 PSI	65 PSI

MAXIMUM PERMISSIBLE HOIST LINE LOAD

LINE PARTS	1	2	3	4	5	6	7	8
MAX. LOAD	9,080	18,160	27,240	36,320	45,400	54,480	65,560	72,640
BOOM HEAD	2	3-D	2-3	1-4-D	2-3-4	2-3-4-D	1-2-3-4	1-2-3-4-D
HOOK BLOCK	0	3	3-D	1-4	2-3-D	2-3-4	2-3-4-D	1-2-3-4

WIRE ROPE: 5/8" ROTATION RESISTANT COMPACTED STRAND, 18X19 OR 19X19 MINIMUM BREAKING STRENGTH - 22.7 TONS

5/8" 6X19 OR 6X37 IMPC IPS PREFORMED RIGHT REGULAR LAY MINIMUM BREAKING STRENGTH - 17.9 TONS



TEREX

General Notes | RT300 Series

GENERAL

1. Rated loads as shown on Lift Charts pertain to this machine as originally manufactured and equipped. Modifications to the machine or use of optional equipment or other than that specified can result in a reduction of capacity.
2. Construction equipment can be hazardous if improperly operated or maintained. Operation and maintenance of this machine shall be in compliance with the information in the Operator's, Parts and Safety Manuals supplied with this machine. If These manuals are missing, order replacements from the manufacturer through your distributor.
3. These warnings do not constitute all of the operating conditions for the crane. The operator and job site supervision must read the OPERATORS MANUAL, CIMA SAFETY MANUAL, APPLICABLE OSHA REGULATIONS, AND SOCIETY OF MECHANICAL ENGINEERS (ASME) SAFETY STANDINGS FOR CRANES.
4. This crane and its load ratings are in accordance with POWER CRANE & SHOVEL ASSOCIATION, STANDARD NO. 4 SAE CRANE LOAD STABILITY TEST CODE J765A, SAE METHOD OF TEST FOR CRANE STRUCTURE J1063 AND APPLICABLE SAFETY CODE FOR CRANES, DERRICKS AND HOISTS, ASME/ANSI B30.5

DEFINITIONS

1. **LOAD RADIUS** - The horizontal distance from the axis of rotation before loading to the center of the vertical hoist line or tackle with a load applied.
2. **LOADED BOOM ANGLE** - It is the angle between the boom base section and the horizontal, after lifting the rated load at the rated radius. The boom angle before loading should be greater to account for deflections. The loaded boom angle combined with boom length give only an approximation of the operating radius.
3. **WORKING AREA** - Areas measured in a circular arc about the centerline of rotation as shown in the diagram.
4. **FREELY SUSPENDED LOAD** - Load hanging free with no direct external force applied except by the hoist rope.
5. **SIDE LOAD** - Horizontal force applied to the lifted load either on the ground or in the air.
6. **NO LOAD STABILITY LIMIT** - The stability limit radius shown on the range diagrams is the radius beyond which it is not permitted to position the boom, when the boom angle is less than the minimum shown on the applicable load chart, because the machine can overturn without any load.
7. **BOOM SIDE OF CRANE** - The side of the crane over which the boom is positioned when in OVER SIDE working position.

SET-UP

1. Crane load ratings are based on the crane being leveled and standing on a firm, uniform supporting surface.
2. Crane load ratings on outriggers are based on all outrigger beams being fully extended or in the case of partial extension ratings mechanically pinned in the appropriate position, and the tires free of the supporting surface.
3. Crane load ratings on tires depend on appropriate inflation pressure and the tire conditions. Caution must be exercised when increasing air pressures in tires. Consult Operator's Manual for precautions.
4. Use of jibs, lattice-type boom extensions, or fourth section pullouts extended is not permitted for pick and carry operations.
5. Consult appropriate section of the Operator's and Service Manual for more exact description of hoist line reeving.
6. The use of more parts of line than required by the load may result in having insufficient rope to allow the hook block to reach the ground.
7. Properly maintained wire rope is essential for safe crane operation. Consult Operator's Manual for proper maintenance and inspection requirements.
8. When spin-resistant wire rope is used, the allowable rope loading shall be the breaking strength divided by five (5), unless otherwise specified by the wire rope manufacturer.
9. Do not elevate the boom above 60° unless the boom is positioned in-line with the crane's chassis or the outrigger are extended. Failure to observe this warning may result in loss of stability.

OPERATION

1. **CRANE LOAD RATINGS MUST NOT BE EXCEEDED. DO NOT ATTEMPT TO TIP THE CRANE TO DETERMINE ALLOWABLE LOADS.**
2. When either radius or boom length, or both, are between listed values, the smaller of the two listed load ratings shall be used.
3. Do not operate at longer radii than those listed on the applicable load rating chart (cross hatched areas shown on range diagrams.)
4. The boom angles shown on the Capacity Chart give an approximation of the operating radius for a specified boom length. The boom angle, before loading, should be greater to account for boom deflection. It may be necessary to retract the boom if maximum boom angle is insufficient to maintain rated radius.
5. Power telescoping boom sections must be extended equally.
6. Rated loads include the weight of hook block, slings, and auxiliary lifting devices. Their weights shall be subtracted from the listed rated load to obtain the net load that can be lifted. When lifting over the jib the weight of any hook block, slings, and auxiliary lifting devices at the boom head must be added to the load. When jibs are erected but unused add two (2) times the weight of any hook block, slings, and auxiliary lifting devices at the jib head to the load.
7. Rated loads do not exceed 85% on outriggers or 75% on tires, of the tipping load as determined by SAE Crane Stability Test Code J765a. Structural strength ratings in chart are indicated with an asterisk (*).
8. Rated loads are based on freely suspended loads. No attempt shall be made to drag a load horizontally on the ground in any direction.
9. The user shall operate at reduced ratings to allow for adverse job conditions, such as: soft or uneven ground, out of level conditions, high winds, side loads, pendulum action, jerking or sudden stopping of loads, hazardous conditions, experience of personnel, two machine lifts, traveling with loads, electric wires, etc. (side pull on boom or jib is hazardous). Derating of the cranes lifting capacity is required when wind speed exceeds 20 MPH. The center of the lifted load must never be allowed to move more than 3" off the center line of the base boom section due to the effects of wind, inertia, or any combination of the two.
**Use 2' off the center line of the base boom for a two section boom, 3' for a three section boom, or 4' for a four section boom.
10. The maximum load which can be telescoped is not definable, because of variations in loadings and crane maintenance, but it is permissible to attempt retraction and extension if load ratings are not exceeded.
11. Load ratings are dependent upon the crane being maintained according to manufacturer's specifications.
12. It is recommended that load handling devices, including hooks, and hook blocks, be kept away from boom head at all times.
13. **FOR TRUCK CRANES ONLY:** 360° capacities apply only to machines equipped with a front outrigger jack and all five(5) outrigger jacks properly set. If the front (5th) outrigger jack is not properly set, the work area is restricted to the over side and over rear areas as shown on the Crane Working Positions diagram. Use the 360° load ratings in the overside work areas.
14. Do not lift with outrigger beams positioned between the fully extended and intermediate (pinned) positions.
15. Truck Cranes not equipped with equalizing (bogie) beams between the rear axles may not be used for lifting "on tires". Truck Cranes equipped with equalizing beams and rear air suspension should "dump" the air before lifting "on tires".

CLAMSHELL, MAGNET, AND CONCRETE BUCKET SERVICE

1. Maximum boom length for clamshell and magnet service is 50'.
2. Weight of clamshell or magnet, plus contents are not to exceed 6,000 lb or 90% of rated lifting capacities, whichever is less. For concrete bucket operation, weight of bucket and load must not exceed 90% of rated lifting capacity.

TEREX Cranes
106-12th Street S.E.
Waverly, Iowa 50677-9466 USA

TEL (319) 352-3920 FAX (319) 352-5727
EMAIL inquire@terexwaverly.com
WEB terex.com

WE RESERVE THE RIGHT TO AMEND THESE SPECIFICATIONS AT ANY TIME WITHOUT NOTICE. THE ONLY WARRANTY APPLICABLE IS OUR STANDARD WRITTEN WARRANTY APPLICABLE TO THE PARTICULAR PRODUCT AND SALE. WE MAKE NO OTHER WARRANTY, EXPRESSED OR IMPLIED.

©TEREX CRANES, INC 2005

PRINTED IN U.S.A.

MARCH 7, 2005