

HK 65

65 METRISCHE TONNEN TRAGLAST / 65 METRIC TON CAPACITY

TRUCK CRANE



Maße (mm)
Dimensions (mm)

DIN/ISO/EN

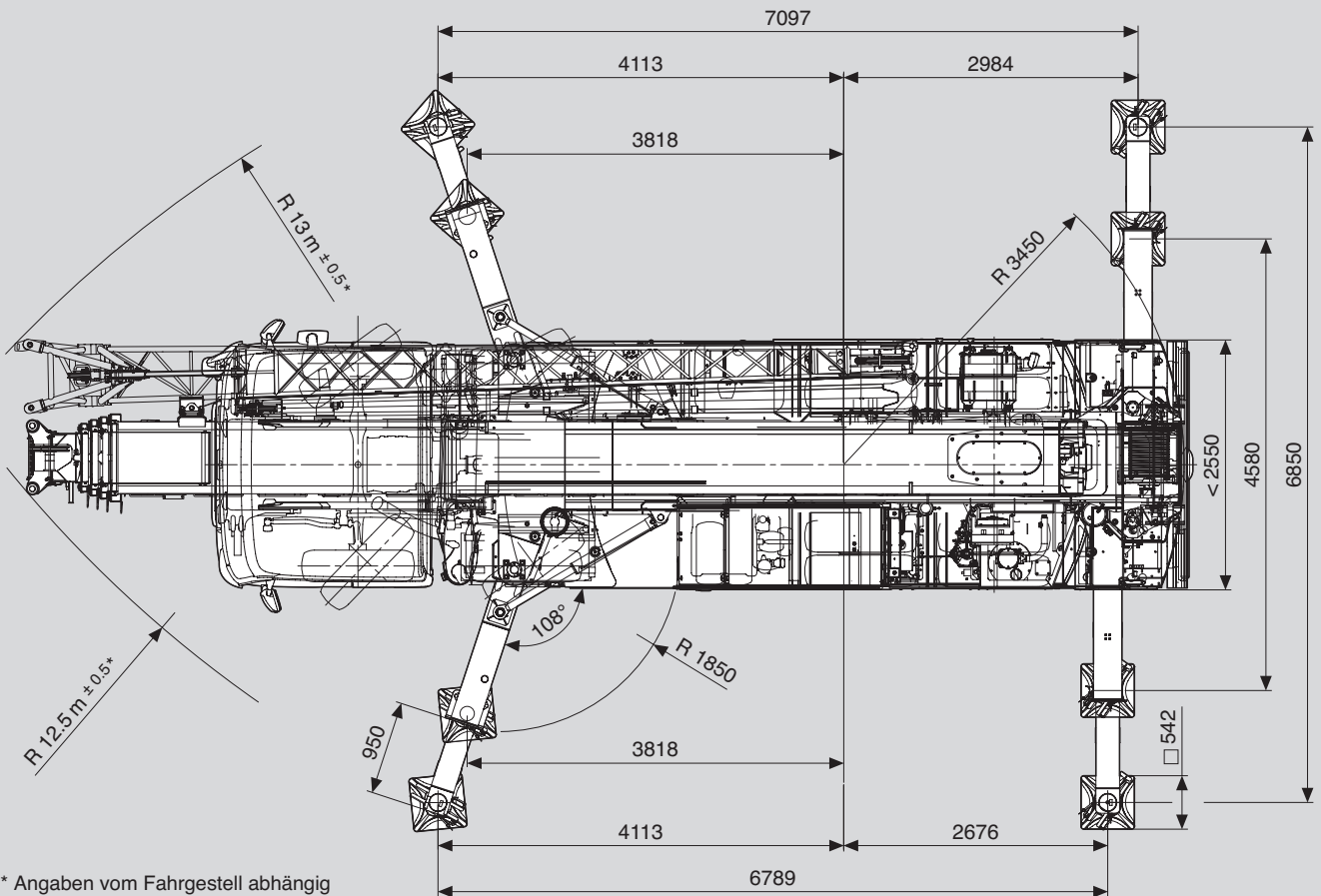
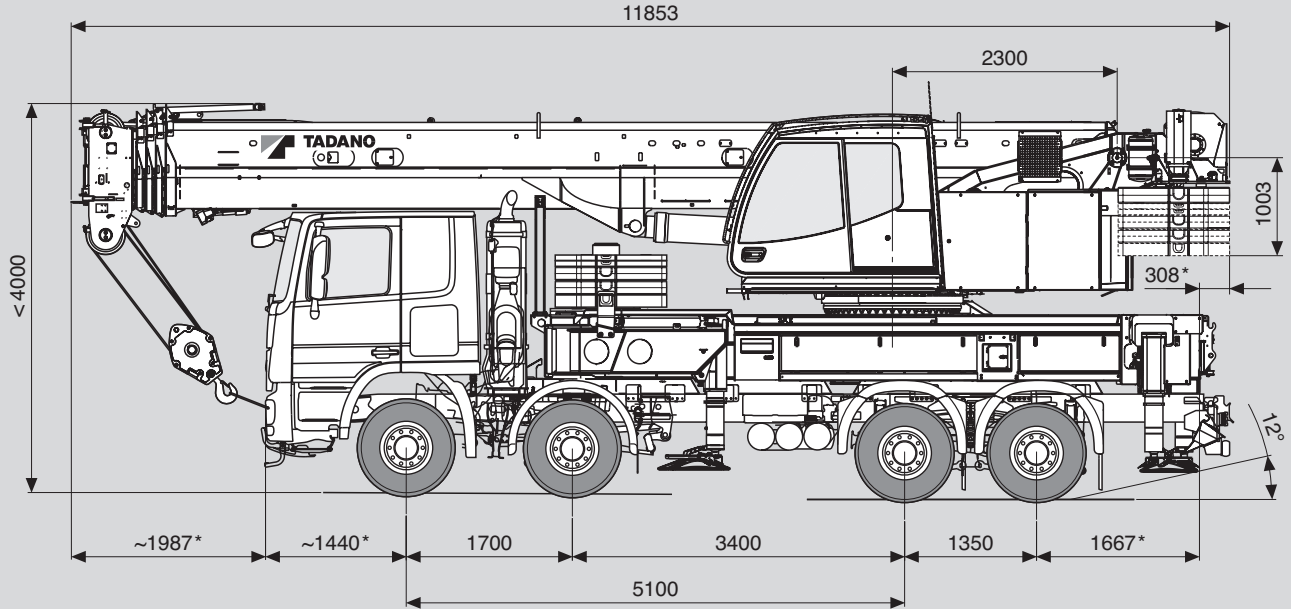

* Angaben vom Fahrgestell abhängig
* Data depending on chassis

	Achse / Axle	1	2	3	4	Gesamtgewicht / Total weight
	4 - (t)	$\leq 6.7^*$	$\leq 6.7^*$	$\leq 9.3^*$	$\leq 9.3^*$	$\leq 32^*$
4 - (t)	$\leq 10^{**}$	$\leq 10^{**}$	$\leq 12^{**}$	$\leq 12^{**}$	$\leq 44^{**}$	

* Abhängig vom Fahrgestell und Optionen, incl. Unterflasche Typ 12,5, 750 kg Anschlagmittelreserve (nur nach Vorgabe TADANO).
 * Depending on chassis and options, incl. hook block type 12.5, + 750 kg extra for tackle etc. (only in accordance to TADANO requirements).
 ** Abhängig vom Fahrgestell und Optionen, incl. 10,1 t Gegengewicht, Unterflasche Typ 12,5, Hakengeschirr Typ 6.
 ** Abhängig vom Fahrgestell und Optionen, incl. 9,1 t Gegengewicht, 8,8 m/15,8 m Auslegerverlängerung, Unterflasche Typ 12,5, Hakengeschirr Typ 6.
 ** Depending on chassis and options, incl. 10.1 t counterweight, hook block type 12.5, swivel hook type 6.
 ** Depending on chassis and options, incl. 9.1 t counterweight, 8.8 m/15.8 m boom extension, hook block type 12.5, swivel hook type 6.

	Traglast / Lifting capacity	Rollen / Sheaves	Stränge / Parts of line	Gewicht / Weight
	30.5 t (Typ / Type 32)	3	7	300 kg
	8.8 t (Typ / Type 12.5)	1	2	200 kg
	4.5 t (Typ / Type 6)	–	1	150 kg



km/h	Alle diese Daten abhängig vom Fahrgestell This data depending on chassis						
km/h							

V+	Stufenlos Infinitely variable	Seil Rope	Max. Seilzug Max. single line pull
	0 - 130 m/min für einfachen Strang single line	16 mm / 205 m	44 kN
	0 - 2 min ⁻¹		
	- 2° – + 82° ca. 33 s approx. 33 s		
	10.4 m – 41.0 m ca. 215 s approx. 215 s		

Hubhöhen
Lifting heights

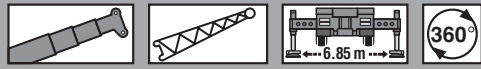

DIN/ISO/EN

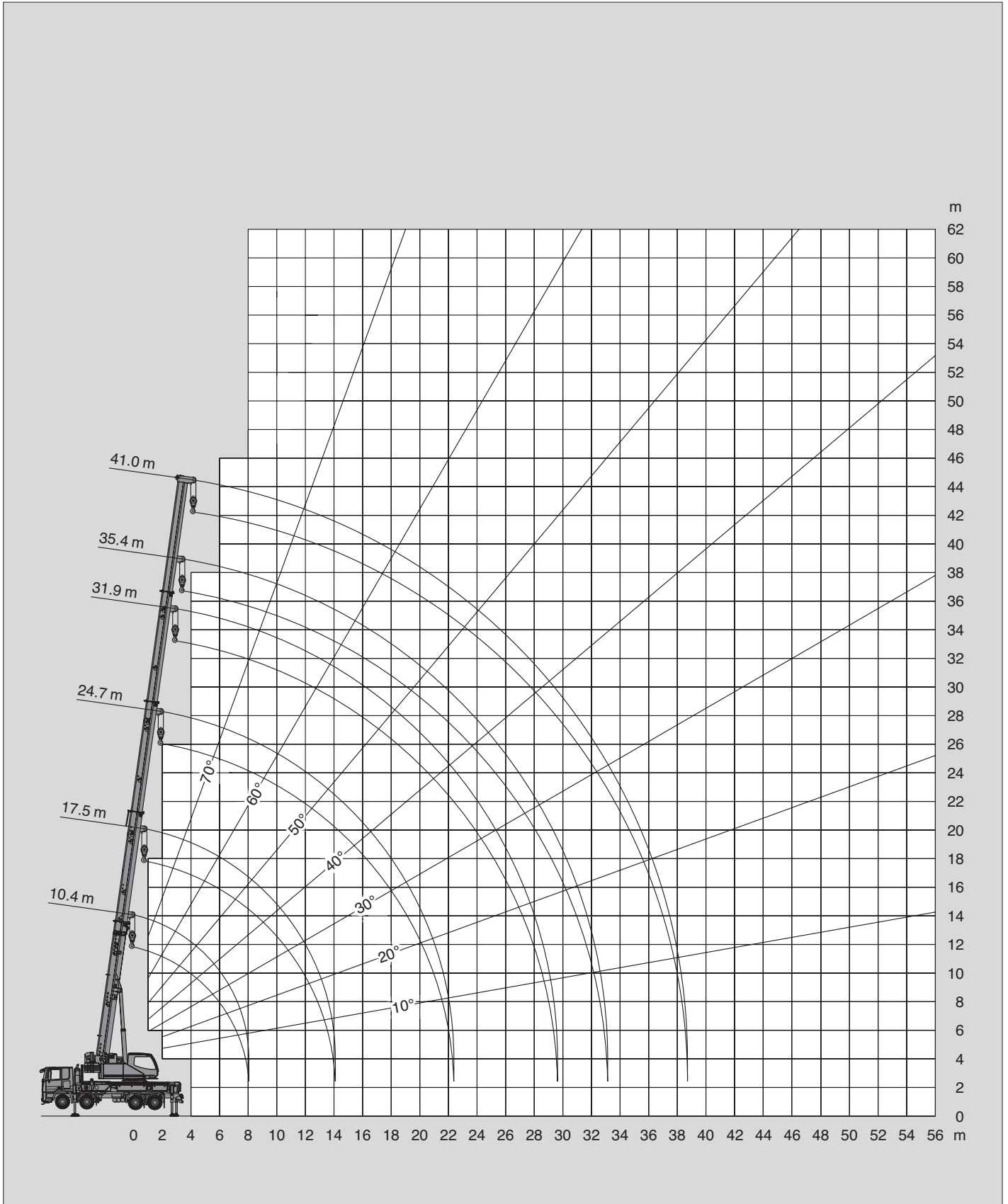

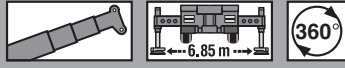
 15.2t DIN/ISO/EN											
↗ m	10.4 m*	10.4 m	13.9 m	17.5 m	21.1 m	24.7 m	28.3 m	31.9 m	35.4 m	39.0 m	41.0 m
2.5	65.0**										
3.0	58.6**	53.3**	50.0	49.5	40.9						
3.5	53.8**	47.6	47.5	46.0	38.4	29.6					
4.0	49.4	42.9	43.1	42.5	36.2	29.6	23.2				
4.5	43.6	38.9	39.1	38.6	34.2	29.3	22.2				
5.0	39.0	35.5	35.7	35.2	32.5	27.8	21.1	18.5			
6.0	32.1	30.0	30.2	29.7	29.4	25.2	19.2	16.9	14.8		
7.0	27.1	25.8	26.0	25.5	25.9	23.0	17.3	15.6	14.0	12.0	
8.0	19.8	19.8	22.7	22.2	22.6	21.1	15.7	14.4	13.0	11.7	10.5
9.0			20.1	20.1	19.9	19.6	14.4	13.3	12.1	11.0	10.4
10.0			17.9	18.4	17.7	18.1	13.3	12.4	11.3	10.3	9.8
11.0			16.3	16.6	15.9	16.3	12.3	11.4	10.6	9.7	9.2
12.0				14.8	14.3	14.4	11.5	10.6	9.9	9.1	8.6
14.0				11.7	11.6	11.3	10.0	9.3	8.8	8.1	7.5
16.0					9.4	9.2	8.9	8.2	7.8	7.3	6.6
18.0					8.0	7.6	7.3	7.3	7.0	6.6	5.9
20.0						6.4	6.1	6.3	6.2	6.0	5.3
22.0						5.7	5.2	5.8	5.3	5.5	4.8
24.0							4.8	5.0	4.8	4.7	4.4
26.0								4.4	4.3	4.1	4.0
28.0								3.8	3.8	3.5	3.5
30.0									3.3	3.1	3.1
32.0									2.9	2.7	2.7
34.0										2.3	2.3
36.0										2.0	2.0
38.0											1.8

* Nach hinten / * Over rear

** Mit Zusatzhubausrüstung / ** With additional lifting equipment

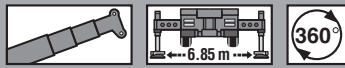

 10.1t¹⁾ DIN/ISO/EN											
↗ m	10.4 m*	10.4 m	13.9 m	17.5 m	21.1 m	24.7 m	28.3 m	31.9 m	35.4 m	39.0 m	41.0 m
2.5	65.0**										
3.0	58.6**	51.7**	50.0	49.5	40.9						
3.5	53.5**	46.0	46.3	45.8	38.4	29.7					
4.0	46.5	41.3	41.6	41.1	36.2	29.7	23.2				
4.5	41.1	37.4	37.7	37.1	34.2	29.3	22.2				
5.0	36.7	34.0	34.3	33.8	32.5	27.8	21.1	18.5			
6.0	30.1	28.6	28.9	28.4	28.8	25.2	19.2	16.9	14.8		
7.0	25.4	24.5	24.8	24.2	24.6	23.0	17.3	15.6	14.0	12.0	
8.0	19.8	18.3	21.5	21.6	21.4	21.1	15.7	14.4	13.0	11.7	10.5
9.0			18.8	19.5	18.6	18.5	14.4	13.3	12.1	11.0	10.4
10.0			16.1	16.5	16.4	16.0	13.3	12.4	11.3	10.3	9.8
11.0			13.8	14.1	14.1	13.7	12.3	11.4	10.6	9.7	9.2
12.0				12.3	12.2	11.9	11.5	10.6	9.9	9.1	8.6
14.0				9.6	9.7	9.3	9.0	9.0	8.8	8.1	7.5
16.0					8.1	7.5	7.1	7.7	7.3	7.3	6.6
18.0					6.7	6.7	6.3	6.5	6.3	6.2	5.9
20.0						5.6	5.7	5.4	5.4	5.2	5.2
22.0						4.8	4.8	4.6	4.5	4.3	4.3
24.0							4.1	3.9	3.8	3.6	3.6
26.0								3.4	3.3	3.1	3.1
28.0								2.9	2.8	2.6	2.6
30.0									2.4	2.2	2.2
32.0									2.1	1.8	1.8
34.0										1.5	1.5
36.0										1.3	1.3
38.0											1.1

1) Zum Mitführen, nur mit spezieller Fahrgestellvariante / To be included for traveling, only with specified chassis type

* Nach hinten / * Over rear

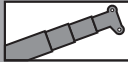
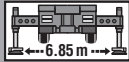

** Mit Zusatzhubausrüstung / ** With additional lifting equipment

Tragfähigkeiten Lifting capacities

   9.1 t DIN/ISO/EN											
→ m	10.4 m*	10.4 m	13.9 m	17.5 m	21.1 m	24.7 m	28.3 m	31.9 m	35.4 m	39.0 m	41.0 m
2.5	65.0**										
3.0	58.6**	51.5	50.0	49.5	40.9						
3.5	53.0**	45.8	46.1	45.5	38.4	29.7					
4.0	46.1	41.1	41.4	40.8	36.2	29.7	23.2				
4.5	40.7	37.1	37.4	36.9	34.2	29.3	22.2				
5.0	36.4	33.8	34.1	33.5	32.5	27.8	21.1	18.5			
6.0	29.8	28.4	28.7	28.1	28.5	25.2	19.2	16.9	14.8		
7.0	25.2	24.3	24.6	24.1	24.4	23.0	17.3	15.6	14.0	12.0	
8.0	19.8	18.3	21.3	21.4	21.2	21.1	15.7	14.4	13.0	11.7	10.5
9.0			18.7	19.1	18.2	17.9	14.4	13.3	12.1	11.0	10.4
10.0			15.7	16.0	16.0	15.7	13.3	12.4	11.3	10.3	9.8
11.0			13.4	13.7	13.7	13.4	12.3	11.4	10.6	9.7	9.2
12.0				12.0	11.9	11.6	11.3	10.6	9.9	9.1	8.6
14.0				9.3	9.7	9.0	8.7	8.8	8.8	8.1	7.5
16.0					7.9	7.5	7.0	7.7	7.1	7.3	6.6
18.0					6.5	6.5	6.3	6.3	6.3	6.0	5.9
20.0						5.4	5.5	5.3	5.2	5.0	5.0
22.0						4.6	4.7	4.5	4.4	4.1	4.1
24.0							4.0	3.8	3.7	3.5	3.5
26.0								3.2	3.1	2.9	2.9
28.0								2.8	2.7	2.5	2.5
30.0									2.3	2.1	2.1
32.0									2.0	1.7	1.7
34.0										1.4	1.4
36.0										1.2	1.2
38.0											1.0



* Nach hinten / * Over rear

** Mit Zusatzhubausrüstung / ** With additional lifting equipment

   8.1 t DIN/ISO/EN											
→ m	10.4 m*	10.4 m	13.9 m	17.5 m	21.1 m	24.7 m	28.3 m	31.9 m	35.4 m	39.0 m	41.0 m
2.5	65.0**										
3.0	58.6**	51.2	50.0	49.5	40.9						
3.5	52.4**	45.5	45.8	45.3	38.4	29.7					
4.0	45.6	40.8	41.1	40.6	36.2	29.7	23.2				
4.5	40.2	36.9	37.1	36.6	34.2	29.3	22.2				
5.0	36.0	33.5	33.8	33.3	32.5	27.8	21.1	18.5			
6.0	29.5	28.2	28.4	27.9	28.3	25.2	19.2	16.9	14.8		
7.0	24.9	24.1	24.3	24.1	24.2	23.0	17.3	15.6	14.0	12.0	
8.0	19.8	18.2	21.1	21.4	20.6	20.2	15.7	14.4	13.0	11.7	10.5
9.0			17.9	18.3	17.7	17.3	14.4	13.3	12.1	11.0	10.4
10.0			15.0	15.3	15.3	15.0	13.3	12.4	11.3	10.3	9.8
11.0			12.8	13.1	13.1	12.8	12.3	11.4	10.6	9.7	9.2
12.0				11.4	11.3	11.1	10.7	10.6	9.9	9.1	8.6
14.0				8.9	9.2	8.5	8.2	8.6	8.5	8.1	7.5
16.0					7.5	7.4	7.0	7.3	7.0	7.0	6.6
18.0					6.2	6.1	6.1	5.9	5.9	5.6	5.6
20.0						5.1	5.1	4.9	4.8	4.6	4.6
22.0						4.3	4.3	4.1	4.0	3.8	3.8
24.0							3.7	3.5	3.4	3.2	3.2
26.0								3.0	2.9	2.6	2.6
28.0								2.5	2.4	2.2	2.2
30.0									2.0	1.8	1.8
32.0									1.7	1.5	1.5
34.0										1.2	1.2
36.0										1.0	1.0
38.0											0.8

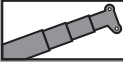
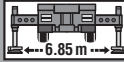

* Nach hinten / * Over rear

** Mit Zusatzhubausrüstung / ** With additional lifting equipment

   5.1 t DIN/ISO/EN											
↗ m	10.4 m*	10.4 m	13.9 m	17.5 m	21.1 m	24.7 m	28.3 m	31.9 m	35.4 m	39.0 m	41.0 m
2.5	65.0**										
3.0	58.6**	50.0	50.0	49.5	40.9						
3.5	50.4	44.4	44.7	44.2	38.4	29.7					
4.0	43.8	39.7	40.0	39.5	36.2	29.7	23.2				
4.5	38.7	35.8	36.1	35.6	34.2	29.3	22.2				
5.0	34.5	32.5	32.8	32.2	32.5	27.8	21.1	18.5			
6.0	28.3	27.2	27.5	26.9	26.7	25.2	19.2	16.9	14.8		
7.0	23.7	23.2	23.4	23.4	21.6	21.0	17.3	15.6	14.0	12.0	
8.0	18.3	18.3	19.5	19.8	19.3	17.6	15.7	14.4	13.0	11.7	10.5
9.0			15.8	16.2	16.1	15.1	14.4	13.3	12.1	11.0	10.4
10.0			13.2	13.5	13.5	13.2	12.2	11.8	11.3	10.3	9.8
11.0			11.2	11.6	11.7	11.2	10.9	10.4	10.2	9.7	9.2
12.0				10.0	10.4	9.7	9.3	9.7	9.0	9.1	8.6
14.0				7.7	8.1	8.0	7.8	7.9	7.8	7.5	7.1
16.0					6.4	6.4	6.4	6.2	6.1	5.9	5.9
18.0					5.2	5.2	5.2	5.0	4.9	4.7	4.7
20.0						4.3	4.3	4.1	4.0	3.8	3.8
22.0						3.6	3.6	3.4	3.3	3.1	3.1
24.0							3.0	2.8	2.7	2.5	2.5
26.0								2.3	2.2	2.0	2.0
28.0								1.9	1.8	1.6	1.6
30.0									1.5	1.3	1.3
32.0									1.2	1.0	1.0
34.0										0.7	0.7

* Nach hinten / * Over rear

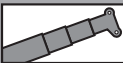
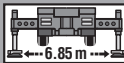
** Mit Zusatzhubausrüstung / ** With additional lifting equipment

   0 t DIN/ISO/EN											
↗ m	10.4 m*	10.4 m	13.9 m	17.5 m	21.1 m	24.7 m	28.3 m	31.9 m	35.4 m	39.0 m	41.0 m
2.5	60.0**										
3.0	55.4**	48.1	48.4	47.9	40.9						
3.5	47.2	42.5	42.8	42.3	38.4	29.7					
4.0	41.0	37.9	38.2	37.6	36.2	29.7	23.2				
4.5	36.2	34.0	34.3	33.7	31.7	29.3	22.2				
5.0	32.3	30.7	31.0	29.6	27.2	25.9	21.1	18.5			
6.0	25.0	25.0	24.4	23.5	21.9	20.2	18.6	16.9	14.8		
7.0	18.2	18.2	19.1	18.8	17.7	16.4	15.1	14.3	13.8	12.0	
8.0	14.0	14.0	14.9	15.2	14.7	13.5	12.4	12.8	12.0	11.3	10.5
9.0			11.9	12.3	12.8	11.9	11.2	10.9	10.4	9.6	9.4
10.0			9.6	10.0	10.5	10.4	10.1	9.4	8.9	8.2	8.0
11.0			8.0	8.3	8.8	8.7	8.8	8.1	7.7	7.0	6.9
12.0				7.0	7.4	7.4	7.4	7.2	6.7	6.1	6.0
14.0				5.0	5.4	5.4	5.4	5.3	5.1	4.9	4.9
16.0					4.1	4.1	4.1	3.9	3.8	3.6	3.6
18.0					3.2	3.1	3.2	3.0	2.9	2.7	2.7
20.0						2.4	2.5	2.3	2.2	2.0	2.0
22.0						1.9	1.9	1.8	1.7	1.4	1.4
24.0							1.5	1.3	1.2	1.0	1.0
26.0								1.0	0.9	0.7	0.7
28.0								0.7	0.6		

* Nach hinten / * Over rear



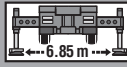
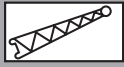
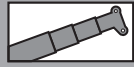

** Mit Zusatzhubausrüstung / ** With additional lifting equipment



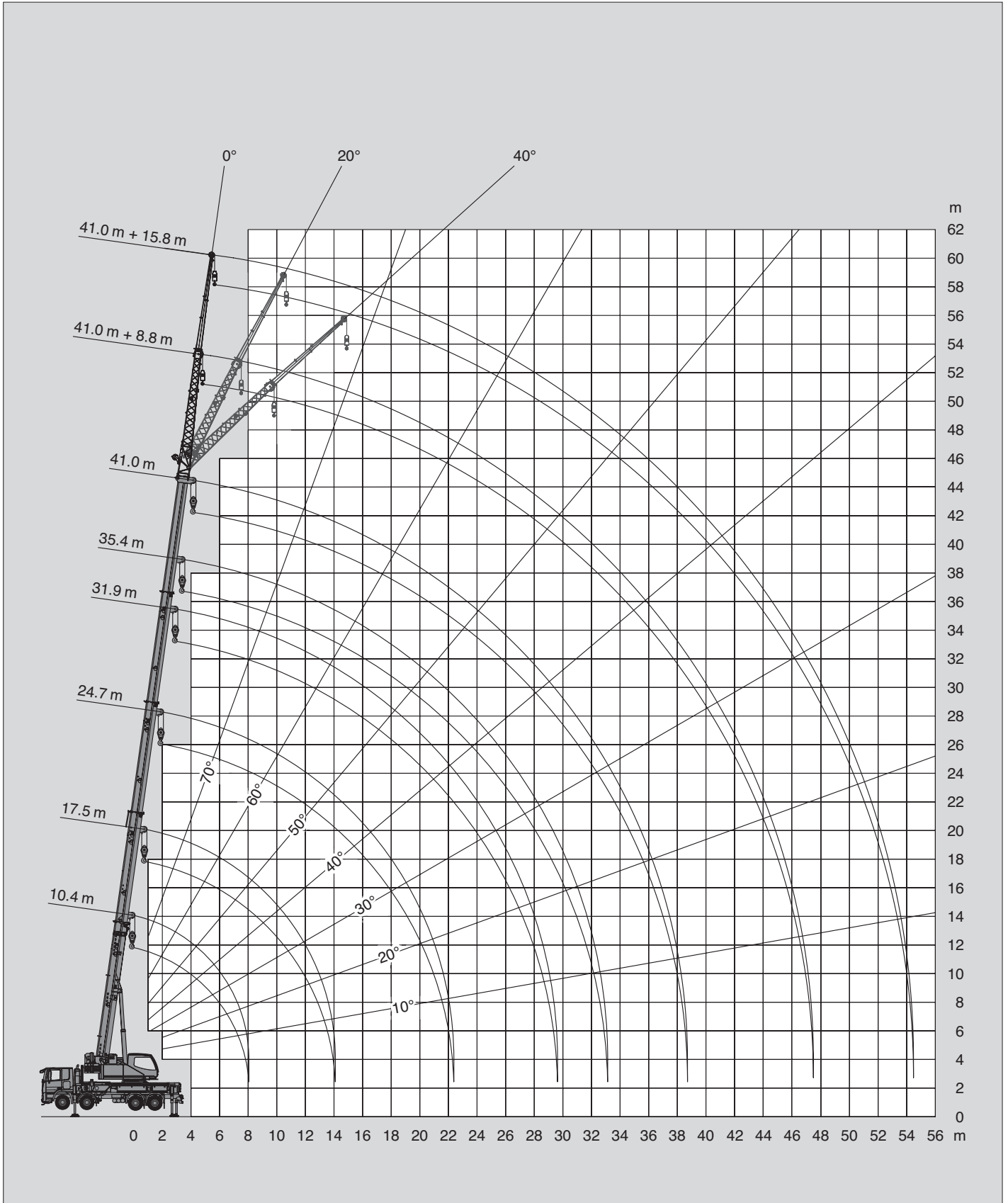

Hubhöhen
Lifting heights

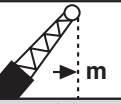

DIN/ISO/EN

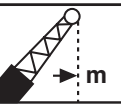

     DIN/ISO/EN															
 m	10.4 m + 8.8 m			24.7 m + 8.8 m			28.3 m + 8.8 m			39.0 m + 8.8 m			41.0 m + 8.8 m		
	0°	20°	40°	0°	20°	40°	0°	20°	40°	0°	20°	40°	0°	20°	40°
3.0	8.8														
3.5	8.8														
4.0	8.8	6.8		8.8											
4.5	8.8	6.5		8.8											
5.0	8.6	6.3		8.8			8.8								
6.0	7.8	5.8	4.8	8.8			8.8								
7.0	7.1	5.5	4.6	8.8	6.1		8.8								
8.0	6.5	5.1	4.4	8.6	5.9		8.8	5.9		6.0			5.5		
9.0	6.0	4.8	4.2	8.2	5.7	4.5	8.3	5.7		6.0			5.5		
10.0	5.6	4.6	4.0	7.7	5.5	4.4	7.9	5.5	4.4	6.0			5.5		
11.0	5.2	4.4	3.9	7.3	5.3	4.3	7.6	5.3	4.3	6.0	5.2		5.5	5.2	
12.0	4.9	4.2	3.8	7.0	5.1	4.2	7.2	5.2	4.2	6.0	5.1		5.5	5.0	
14.0	4.3	3.9	3.6	6.4	4.7	4.0	6.6	4.9	4.0	5.6	4.8	4.0	5.4	4.8	4.0
16.0	3.9	3.7		5.8	4.5	3.8	6.1	4.6	3.9	5.0	4.6	3.9	4.9	4.6	3.8
18.0				5.4	4.2	3.7	5.7	4.4	3.7	4.6	4.4	3.7	4.4	4.2	3.7
20.0				5.0	4.0	3.6	5.3	4.2	3.6	4.2	4.0	3.6	4.1	3.9	3.6
22.0				4.7	3.9	3.5	4.9	4.0	3.5	3.9	3.7	3.5	3.7	3.6	3.5
24.0				4.4	3.7	3.5	4.7	3.8	3.5	3.6	3.5	3.4	3.5	3.3	3.3
26.0				4.2	3.6		4.1	3.7	3.4	3.3	3.2	3.2	3.2	3.1	3.1
28.0				3.9	3.5		3.5	3.6	3.4	3.1	3.0	3.0	3.0	2.9	2.9
30.0				3.4			3.1	3.2		2.9	2.9	2.8	2.8	2.7	2.7
32.0							2.7	2.8		2.7	2.7	2.6	2.5	2.5	2.5
34.0							2.3			2.4	2.5	2.5	2.3	2.3	2.3
36.0										2.1	2.2	2.3	2.0	2.1	2.2
38.0										1.8	1.9		1.8	1.9	2.0
40.0										1.6	1.6		1.5	1.6	
42.0										1.4	1.4		1.3	1.4	
44.0										1.2				1.2	

     DIN/ISO/EN															
 m	10.4 m + 15.8 m			24.7 m + 15.8 m			28.3 m + 15.8 m			39.0 m + 15.8 m			41.0 m + 15.8 m		
	0°	20°	40°	0°	20°	40°	0°	20°	40°	0°	20°	40°	0°	20°	40°
3.0	5.4														
3.5	5.3														
4.0	5.1														
4.5	4.9														
5.0	4.8			4.9											
6.0	4.4			4.7			4.6								
7.0	4.1			4.5			4.5								
8.0	3.9	3.2		4.4			4.3								
9.0	3.6	3.0		4.2			4.2								
10.0	3.4	2.8		4.1			4.1		3.4	3.4					
11.0	3.2	2.7		3.9	2.9		3.9		3.4	3.4			3.1		
12.0	3.0	2.6	2.3	3.7	2.8		3.8	2.8	3.4	3.4			3.1		
14.0	2.7	2.3	2.1	3.4	2.6		3.5	2.6	3.3	3.3	2.6		3.1		
16.0	2.5	2.1	2.0	3.2	2.5	2.1	3.3	2.5	3.2	3.2	2.5		3.1	2.5	
18.0	2.2	2.0	1.9	3.0	2.3	2.0	3.1	2.4	3.0	3.0	2.4		3.0	2.3	
20.0	2.1	1.9	1.8	2.8	2.2	1.9	2.9	2.2	2.9	2.9	2.3	1.9	2.9	2.2	1.9
22.0	1.9	1.8		2.6	2.1	1.9	2.7	2.1	2.8	2.8	2.2	1.9	2.8	2.2	1.9
24.0				2.4	2.0	1.8	2.5	2.1	2.7	2.7	2.1	1.8	2.6	2.1	1.8
26.0				2.3	1.9	1.8	2.4	2.0	2.5	2.5	2.0	1.8	2.5	2.0	1.8
28.0				2.2	1.9	1.7	2.3	1.9	2.4	2.4	1.9	1.7	2.4	1.9	1.7
30.0				2.1	1.8	1.7	2.2	1.8	2.3	2.3	1.9	1.7	2.3	1.9	1.7
32.0				2.0	1.7	1.7	2.1	1.8	2.2	2.2	1.8	1.6	2.2	1.8	1.6
34.0				1.9	1.7		2.0	1.7	2.1	2.1	1.8	1.6	2.0	1.8	1.6
36.0				1.8	1.7		1.9	1.7	2.1	2.1	1.7	1.6	1.9	1.7	1.6
38.0							1.9	1.7	2.0	2.0	1.7	1.6	1.7	1.7	1.6
40.0							1.8	1.7	1.8	1.8	1.6	1.5	1.6	1.6	1.5
42.0									1.5	1.5	1.6	1.5	1.4	1.5	1.5
44.0									1.3	1.3	1.5	1.5	1.3	1.4	1.4
46.0									1.2	1.2	1.3	1.3	1.1	1.2	1.3

Tragfähigkeiten Lifting capacities

															DIN/ISO/EN		
 m	10.4 m + 8.8 m			24.7 m + 8.8 m			28.3 m + 8.8 m			39.0 m + 8.8 m			41.0 m + 8.8 m				
	0°	20°	40°	0°	20°	40°	0°	20°	40°	0°	20°	40°	0°	20°	40°		
3.0	8.8																
3.5	8.8																
4.0	8.8	6.8		8.8													
4.5	8.8	6.5		8.8													
5.0	8.6	6.3		8.8			8.8										
6.0	7.8	5.8	4.8	8.8			8.8										
7.0	7.1	5.5	4.6	8.8	6.1		8.8										
8.0	6.5	5.1	4.4	8.6	5.9		8.8	5.9		6.0			5.5				
9.0	6.0	4.8	4.2	8.2	5.7	4.5	8.3	5.7		6.0			5.5				
10.0	5.6	4.6	4.0	7.7	5.5	4.4	7.9	5.5	4.4	6.0			5.5				
11.0	5.2	4.4	3.9	7.3	5.3	4.3	7.6	5.3	4.3	6.0	5.2		5.5	5.2			
12.0	4.9	4.2	3.8	7.0	5.1	4.2	7.2	5.2	4.2	6.0	5.1		5.5	5.0			
14.0	4.3	3.9	3.6	6.4	4.7	4.0	6.6	4.9	4.0	5.6	4.8	4.0	5.4	4.8	4.0		
16.0	3.9	3.7		5.8	4.5	3.8	6.1	4.6	3.9	5.0	4.6	3.9	4.9	4.6	3.8		
18.0				5.4	4.2	3.7	5.7	4.4	3.7	4.6	4.4	3.7	4.4	4.2	3.7		
20.0				5.0	4.0	3.6	5.1	4.2	3.6	4.2	4.0	3.6	4.1	3.9	3.6		
22.0				4.6	3.9	3.5	4.3	4.0	3.5	3.9	3.7	3.5	3.7	3.6	3.5		
24.0				3.9	3.7	3.5	3.6	3.8	3.5	3.6	3.5	3.4	3.5	3.3	3.3		
26.0				3.4	3.5		3.0	3.2	3.3	3.1	3.2	3.2	3.1	3.1	3.1		
28.0				2.9	3.0		2.6	2.7	2.8	2.6	2.8	3.0	2.6	2.8	2.9		
30.0				2.5			2.2	2.3		2.2	2.4	2.6	2.2	2.4	2.6		
32.0							1.8	1.9		1.9	2.0	2.2	1.8	2.0	2.2		
34.0							1.5			1.6	1.7	1.8	1.5	1.7	1.8		
36.0										1.3	1.4	1.5	1.3	1.4	1.5		
38.0										1.1	1.2		1.0	1.2	1.3		
40.0										0.9	1.0		0.8	0.9			
42.0										0.7	0.8		0.7	0.7			
44.0										0.5				0.6			

1) Zum Mitführen, nur mit spezieller Fahrgestellvariante / To be included for traveling, only with specified chassis type



															DIN/ISO/EN		
 m	10.4 m + 15.8 m			24.7 m + 15.8 m			28.3 m + 15.8 m			39.0 m + 15.8 m			41.0 m + 15.8 m				
	0°	20°	40°	0°	20°	40°	0°	20°	40°	0°	20°	40°	0°	20°	40°		
3.0	5.4																
3.5	5.3																
4.0	5.1																
4.5	4.9																
5.0	4.8			4.9													
6.0	4.4			4.7			4.6										
7.0	4.1			4.5			4.5										
8.0	3.9	3.2		4.4			4.3										
9.0	3.6	3.0		4.2			4.2			3.4							
10.0	3.4	2.8		4.1			4.1			3.4			3.1				
11.0	3.2	2.7		3.9	2.9		3.9			3.4			3.1				
12.0	3.0	2.6	2.3	3.7	2.8		3.8	2.8		3.4			3.1				
14.0	2.7	2.3	2.1	3.4	2.6		3.5	2.6		3.3	2.6		3.1				
16.0	2.5	2.1	2.0	3.2	2.5	2.1	3.3	2.5	2.1	3.2	2.5		3.1	2.5			
18.0	2.2	2.0	1.9	3.0	2.3	2.0	3.1	2.4	2.0	3.0	2.4		3.0	2.3			
20.0	2.1	1.9	1.8	2.8	2.2	1.9	2.9	2.2	1.9	2.9	2.3	1.9	2.9	2.2	1.9		
22.0	1.9	1.8		2.6	2.1	1.9	2.7	2.1	1.9	2.8	2.2	1.9	2.8	2.2	1.9		
24.0				2.4	2.0	1.8	2.5	2.1	1.8	2.7	2.1	1.8	2.6	2.1	1.8		
26.0				2.3	1.9	1.8	2.4	2.0	1.8	2.5	2.0	1.8	2.5	2.0	1.8		
28.0				2.2	1.9	1.7	2.3	1.9	1.7	2.4	1.9	1.7	2.4	1.9	1.7		
30.0				2.1	1.8	1.7	2.2	1.8	1.7	2.3	1.9	1.7	2.3	1.9	1.7		
32.0				2.0	1.7	1.7	2.1	1.8	1.7	2.1	1.8	1.6	2.1	1.8	1.6		
34.0				1.9	1.7		1.8	1.7	1.6	1.8	1.8	1.6	1.8	1.8	1.6		
36.0				1.8	1.7		1.5	1.7		1.5	1.7	1.6	1.5	1.7	1.6		
38.0							1.3	1.4		1.3	1.5	1.6	1.2	1.5	1.6		
40.0							1.1	1.2		1.1	1.3	1.4	1.0	1.2	1.4		
42.0										0.9	1.0	1.1	0.8	1.0	1.1		
44.0										0.7	0.8	0.9	0.7	0.8	0.9		
46.0										0.6	0.7		0.5	0.7	0.7		

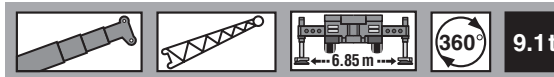
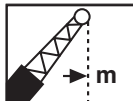

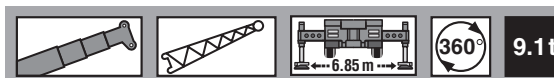
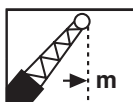
1) Zum Mitführen, nur mit spezieller Fahrgestellvariante / To be included for traveling, only with specified chassis type

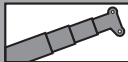
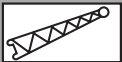
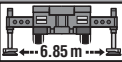

 DIN/ISO/EN															
 m	10.4 m + 8.8 m			24.7 m + 8.8 m			28.3 m + 8.8 m			39.0 m + 8.8 m			41.0 m + 8.8 m		
	0°	20°	40°	0°	20°	40°	0°	20°	40°	0°	20°	40°	0°	20°	40°
3.0	8.8														
3.5	8.8														
4.0	8.8	6.8		8.8											
4.5	8.8	6.5		8.8											
5.0	8.6	6.3		8.8			8.8								
6.0	7.8	5.8	4.8	8.8			8.8								
7.0	7.1	5.5	4.6	8.8	6.1		8.8								
8.0	6.5	5.1	4.4	8.6	5.9		8.8	5.9		6.0			5.5		
9.0	6.0	4.8	4.2	8.2	5.7	4.5	8.3	5.7		6.0			5.5		
10.0	5.6	4.6	4.0	7.7	5.5	4.4	7.9	5.5	4.4	6.0			5.5		
11.0	5.2	4.4	3.9	7.3	5.3	4.3	7.6	5.3	4.3	6.0	5.2		5.5	5.2	
12.0	4.9	4.2	3.8	7.0	5.1	4.2	7.2	5.2	4.2	6.0	5.1		5.5	5.0	
14.0	4.3	3.9	3.6	6.4	4.7	4.0	6.6	4.9	4.0	5.6	4.8	4.0	5.4	4.8	4.0
16.0	3.9	3.7		5.8	4.5	3.8	6.1	4.6	3.9	5.0	4.6	3.9	4.9	4.6	3.8
18.0				5.4	4.2	3.7	5.7	4.4	3.7	4.6	4.4	3.7	4.4	4.2	3.7
20.0				5.0	4.0	3.6	5.0	4.2	3.6	4.2	4.0	3.6	4.1	3.9	3.6
22.0				4.5	3.9	3.5	4.1	4.0	3.5	3.9	3.7	3.5	3.7	3.6	3.5
24.0				3.8	3.7	3.5	3.4	3.7	3.5	3.5	3.5	3.4	3.5	3.3	3.3
26.0				3.2	3.4		2.9	3.1	3.2	3.0	3.2	3.2	2.9	3.1	3.1
28.0				2.8	2.9		2.4	2.6	2.7	2.5	2.7	2.9	2.5	2.7	2.9
30.0				2.4			2.0	2.2		2.1	2.3	2.5	2.1	2.3	2.5
32.0							1.7	1.8		1.8	1.9	2.1	1.7	1.9	2.1
34.0							1.4			1.5	1.6	1.7	1.4	1.6	1.7
36.0										1.2	1.3	1.4	1.2	1.3	1.4
38.0										1.0	1.1		1.0	1.1	1.2
40.0										0.8	0.9		0.8	0.9	
42.0										0.6	0.7		0.6	0.7	
44.0										0.5			0.5		

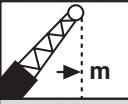
 DIN/ISO/EN															
 m	10.4 m + 15.8 m			24.7 m + 15.8 m			28.3 m + 15.8 m			39.0 m + 15.8 m			41.0 m + 15.8 m		
	0°	20°	40°	0°	20°	40°	0°	20°	40°	0°	20°	40°	0°	20°	40°
3.0	5.4														
3.5	5.3														
4.0	5.1														
4.5	4.9														
5.0	4.8			4.9											
6.0	4.4			4.7			4.6								
7.0	4.1			4.5			4.5								
8.0	3.9	3.2		4.4			4.3								
9.0	3.6	3.0		4.2			4.2								
10.0	3.4	2.8		4.1			4.1			3.4					
11.0	3.2	2.7		3.9	2.9		3.9			3.4			3.1		
12.0	3.0	2.6	2.3	3.7	2.8		3.8	2.8		3.4			3.1		
14.0	2.7	2.3	2.1	3.4	2.6		3.5	2.6		3.3	2.6		3.1		
16.0	2.5	2.1	2.0	3.2	2.5	2.1	3.3	2.5	2.1	3.2	2.5		3.1	2.5	
18.0	2.2	2.0	1.9	3.0	2.3	2.0	3.1	2.4	2.0	3.0	2.4		3.0	2.3	
20.0	2.1	1.9	1.8	2.8	2.2	1.9	2.9	2.2	1.9	2.9	2.3	1.9	2.9	2.2	1.9
22.0	1.9	1.8		2.6	2.1	1.9	2.7	2.1	1.9	2.8	2.2	1.9	2.8	2.2	1.9
24.0				2.4	2.0	1.8	2.5	2.1	1.8	2.7	2.1	1.8	2.6	2.1	1.8
26.0				2.3	1.9	1.8	2.4	2.0	1.8	2.5	2.0	1.8	2.5	2.0	1.8
28.0				2.2	1.9	1.7	2.3	1.9	1.7	2.4	1.9	1.7	2.4	1.9	1.7
30.0				2.1	1.8	1.7	2.2	1.8	1.7	2.3	1.9	1.7	2.3	1.9	1.7
32.0				2.0	1.7	1.7	2.0	1.8	1.7	2.0	1.8	1.6	2.0	1.8	1.6
34.0				1.9	1.7		1.7	1.7	1.6	1.7	1.8	1.6	1.7	1.8	1.6
36.0				1.8	1.7		1.4	1.6		1.4	1.7	1.6	1.4	1.7	1.6
38.0							1.2	1.4		1.2	1.4	1.6	1.2	1.4	1.6
40.0							1.0	1.1		1.0	1.2	1.3	1.0	1.2	1.3
42.0										0.8	1.0	1.1	0.8	1.0	1.1
44.0										0.6	0.8	0.9	0.6	0.8	0.8
46.0										0.5	0.6		0.5	0.6	0.7

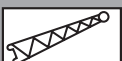
Tragfähigkeiten Lifting capacities

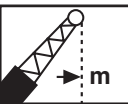
    8.1 t DIN/ISO/EN															
 m	10.4 m + 8.8 m			24.7 m + 8.8 m			28.3 m + 8.8 m			39.0 m + 8.8 m			41.0 m + 8.8 m		
	0°	20°	40°	0°	20°	40°	0°	20°	40°	0°	20°	40°	0°	20°	40°
3.0	8.8														
3.5	8.8														
4.0	8.8	6.8		8.8											
4.5	8.8	6.5		8.8											
5.0	8.6	6.3		8.8			8.8								
6.0	7.8	5.8	4.8	8.8			8.8								
7.0	7.1	5.5	4.6	8.8	6.1		8.8								
8.0	6.5	5.1	4.4	8.6	5.9		8.8	5.9		6.0			5.5		
9.0	6.0	4.8	4.2	8.2	5.7	4.5	8.3	5.7		6.0			5.5		
10.0	5.6	4.6	4.0	7.7	5.5	4.4	7.9	5.5	4.4	6.0			5.5		
11.0	5.2	4.4	3.9	7.3	5.3	4.3	7.6	5.3	4.3	6.0	5.2		5.5	5.2	
12.0	4.9	4.2	3.8	7.0	5.1	4.2	7.2	5.2	4.2	6.0	5.1		5.5	5.0	
14.0	4.3	3.9	3.6	6.4	4.7	4.0	6.6	4.9	4.0	5.6	4.8	4.0	5.4	4.8	4.0
16.0	3.9	3.7		5.8	4.5	3.8	6.1	4.6	3.9	5.0	4.6	3.9	4.9	4.6	3.8
18.0				5.4	4.2	3.7	5.7	4.4	3.7	4.6	4.4	3.7	4.4	4.2	3.7
20.0				5.0	4.0	3.6	4.6	4.2	3.6	4.2	4.0	3.6	4.1	3.9	3.6
22.0				4.2	3.9	3.5	3.8	4.0	3.5	3.9	3.7	3.5	3.7	3.6	3.5
24.0				3.5	3.7	3.5	3.2	3.4	3.5	3.3	3.5	3.4	3.2	3.3	3.3
26.0				3.0	3.1		2.6	2.8	3.0	2.7	3.0	3.2	2.7	2.9	3.1
28.0				2.6	2.6		2.2	2.4	2.4	2.3	2.5	2.7	2.2	2.5	2.7
30.0				2.2			1.8	2.0		1.9	2.1	2.3	1.9	2.1	2.2
32.0							1.5	1.6		1.6	1.7	1.9	1.6	1.7	1.9
34.0							1.2			1.3	1.4	1.6	1.3	1.4	1.6
36.0										1.0	1.2	1.3	1.0	1.1	1.3
38.0										0.8	0.9		0.8	0.9	1.0
40.0										0.6	0.7		0.6	0.7	
42.0										0.5	0.5		0.5	0.5	

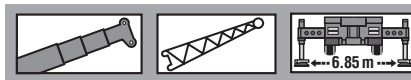
    8.1 t DIN/ISO/EN															
 m	10.4 m + 15.8 m			24.7 m + 15.8 m			28.3 m + 15.8 m			39.0 m + 15.8 m			41.0 m + 15.8 m		
	0°	20°	40°	0°	20°	40°	0°	20°	40°	0°	20°	40°	0°	20°	40°
3.0	5.4														
3.5	5.3														
4.0	5.1														
4.5	4.9														
5.0	4.8			4.9											
6.0	4.4			4.7			4.6								
7.0	4.1			4.5			4.5								
8.0	3.9	3.2		4.4			4.3								
9.0	3.6	3.0		4.2			4.2			3.4					
10.0	3.4	2.8		4.1			4.1			3.4			3.1		
11.0	3.2	2.7		3.9	2.9		3.9			3.4			3.1		
12.0	3.0	2.6	2.3	3.7	2.8		3.8	2.8		3.4			3.1		
14.0	2.7	2.3	2.1	3.4	2.6		3.5	2.6		3.3	2.6		3.1		
16.0	2.5	2.1	2.0	3.2	2.5	2.1	3.3	2.5	2.1	3.2	2.5		3.1	2.5	
18.0	2.2	2.0	1.9	3.0	2.3	2.0	3.1	2.4	2.0	3.0	2.4		3.0	2.3	
20.0	2.1	1.9	1.8	2.8	2.2	1.9	2.9	2.2	1.9	2.9	2.3	1.9	2.9	2.2	1.9
22.0	1.9	1.8		2.6	2.1	1.9	2.7	2.1	1.9	2.8	2.2	1.9	2.8	2.2	1.9
24.0				2.4	2.0	1.8	2.5	2.1	1.8	2.7	2.1	1.8	2.6	2.1	1.8
26.0				2.3	1.9	1.8	2.4	2.0	1.8	2.5	2.0	1.8	2.5	2.0	1.8
28.0				2.2	1.9	1.7	2.3	1.9	1.7	2.4	1.9	1.7	2.4	1.9	1.7
30.0				2.1	1.8	1.7	2.1	1.8	1.7	2.1	1.9	1.7	2.1	1.9	1.7
32.0				2.0	1.7	1.7	1.8	1.8	1.7	1.8	1.8	1.6	1.8	1.8	1.6
34.0				1.8	1.7		1.5	1.7	1.6	1.5	1.8	1.6	1.5	1.8	1.6
36.0				1.6	1.7		1.3	1.5		1.3	1.5	1.6	1.2	1.5	1.6
38.0							1.0	1.2		1.0	1.3	1.4	1.0	1.2	1.4
40.0							0.8	1.0		0.8	1.0	1.2	0.8	1.0	1.1
42.0										0.6	0.8	0.9	0.6	0.8	0.9
44.0										0.5	0.6	0.7	0.5	0.6	0.7

 DIN/ISO/EN															
 m	10.4 m + 8.8 m			24.7 m + 8.8 m			28.3 m + 8.8 m			39.0 m + 8.8 m			41.0 m + 8.8 m		
	0°	20°	40°	0°	20°	40°	0°	20°	40°	0°	20°	40°	0°	20°	40°
3.0	8.8														
3.5	8.8														
4.0	8.8	6.8		8.8											
4.5	8.8	6.5		8.8											
5.0	8.6	6.3		8.8			8.8								
6.0	7.8	5.8	4.8	8.8			8.8								
7.0	7.1	5.5	4.6	8.8	6.1		8.8								
8.0	6.5	5.1	4.4	8.6	5.9		8.8	5.9		6.0			5.5		
9.0	6.0	4.8	4.2	8.2	5.7	4.5	8.3	5.7		6.0			5.5		
10.0	5.6	4.6	4.0	7.7	5.5	4.4	7.9	5.5	4.4	6.0			5.5		
11.0	5.2	4.4	3.9	7.3	5.3	4.3	7.6	5.3	4.3	6.0	5.2		5.5	5.2	
12.0	4.9	4.2	3.8	7.0	5.1	4.2	7.2	5.2	4.2	6.0	5.1		5.5	5.0	
14.0	4.3	3.9	3.6	6.4	4.7	4.0	6.6	4.9	4.0	5.6	4.8	4.0	5.4	4.8	4.0
16.0	3.9	3.7		5.8	4.5	3.8	5.7	4.6	3.9	5.0	4.6	3.9	4.9	4.6	3.8
18.0				4.9	4.2	3.7	4.6	4.4	3.7	4.6	4.4	3.7	4.4	4.2	3.7
20.0				4.0	4.0	3.6	3.6	4.0	3.6	3.7	4.0	3.6	3.7	3.9	3.6
22.0				3.3	3.5	3.5	2.9	3.2	3.4	3.0	3.3	3.5	3.0	3.3	3.5
24.0				2.7	2.9	3.0	2.3	2.6	2.7	2.4	2.7	3.0	2.4	2.7	3.0
26.0				2.2	2.4		1.9	2.1	2.2	2.0	2.2	2.4	1.9	2.2	2.4
28.0				1.8	1.9		1.5	1.6	1.7	1.6	1.8	2.0	1.5	1.7	2.0
30.0				1.5			1.2	1.3		1.2	1.4	1.6	1.2	1.4	1.6
32.0							0.9	1.0		0.9	1.1	1.3	0.9	1.1	1.2
34.0							0.6			0.7	0.8	1.0	0.7	0.8	1.0
36.0										0.5	0.6	0.7		0.6	0.7
38.0															0.5

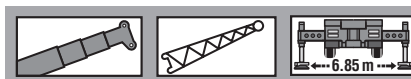
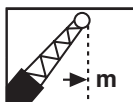
 DIN/ISO/EN															
 m	10.4 m + 15.8 m			24.7 m + 15.8 m			28.3 m + 15.8 m			39.0 m + 15.8 m			41.0 m + 15.8 m		
	0°	20°	40°	0°	20°	40°	0°	20°	40°	0°	20°	40°	0°	20°	40°
3.0	5.4														
3.5	5.3														
4.0	5.1														
4.5	4.9														
5.0	4.8			4.9											
6.0	4.4			4.7			4.6								
7.0	4.1			4.5			4.5								
8.0	3.9	3.2		4.4			4.3								
9.0	3.6	3.0		4.2			4.2								
10.0	3.4	2.8		4.1			4.1			3.4					
11.0	3.2	2.7		3.9	2.9		3.9			3.4			3.1		
12.0	3.0	2.6	2.3	3.7	2.8		3.8	2.8		3.4			3.1		
14.0	2.7	2.3	2.1	3.4	2.6		3.5	2.6		3.3	2.6		3.1		
16.0	2.5	2.1	2.0	3.2	2.5	2.1	3.3	2.5	2.1	3.2	2.5		3.1	2.5	
18.0	2.2	2.0	1.9	3.0	2.3	2.0	3.1	2.4	2.0	3.0	2.4		3.0	2.3	
20.0	2.1	1.9	1.8	2.8	2.2	1.9	2.9	2.2	1.9	2.9	2.3	1.9	2.9	2.2	1.9
22.0	1.9	1.8		2.6	2.1	1.9	2.7	2.1	1.9	2.8	2.2	1.9	2.8	2.2	1.9
24.0				2.4	2.0	1.8	2.5	2.1	1.8	2.7	2.1	1.8	2.6	2.1	1.8
26.0				2.3	1.9	1.8	2.2	2.0	1.8	2.2	2.0	1.8	2.2	2.0	1.8
28.0				2.1	1.9	1.7	1.8	1.9	1.7	1.8	1.9	1.7	1.8	1.9	1.7
30.0				1.8	1.8	1.7	1.4	1.8	1.7	1.5	1.8	1.7	1.4	1.8	1.7
32.0				1.5	1.7	1.7	1.2	1.5	1.6	1.2	1.5	1.6	1.1	1.5	1.6
34.0				1.2	1.4		0.9	1.2	1.3	0.9	1.2	1.4	0.9	1.2	1.4
36.0				1.0	1.2		0.7	0.9		0.7	1.0	1.1	0.7	0.9	1.1
38.0							0.5	0.7		0.5	0.7	0.9	0.5	0.7	0.9
40.0								0.5			0.5	0.6		0.5	0.6

Tragfähigkeiten Lifting capacities



m	10.4 m + 8.8 m			24.7 m + 8.8 m			28.3 m + 8.8 m			39.0 m + 8.8 m			41.0 m + 8.8 m		
	0°	20°	40°	0°	20°	40°	0°	20°	40°	0°	20°	40°	0°	20°	40°
3.0	8.8														
3.5	8.8														
4.0	8.8	6.8		8.8											
4.5	8.8	6.5		8.8											
5.0	8.6	6.3		8.8			8.8								
6.0	7.8	5.8	4.8	8.8			8.8								
7.0	7.1	5.5	4.6	8.8	6.1		8.8								
8.0	6.5	5.1	4.4	8.6	5.9		8.8	5.9		6.0			5.5		
9.0	6.0	4.8	4.2	8.2	5.7	4.5	8.3	5.7		6.0			5.5		
10.0	5.6	4.6	4.0	7.7	5.5	4.4	7.9	5.5	4.4	6.0			5.5		
11.0	5.2	4.4	3.9	7.3	5.3	4.3	7.2	5.3	4.3	6.0	5.2		5.5	5.2	
12.0	4.9	4.2	3.8	7.0	5.1	4.2	6.2	5.2	4.2	5.7	5.1		5.5	5.0	
14.0	4.3	3.9	3.6	5.2	4.7	4.0	4.8	4.9	4.0	4.4	4.8	4.0	4.3	4.8	4.0
16.0	3.9	3.7		3.9	4.3	3.8	3.5	4.0	3.9	3.5	3.9	3.9	3.4	3.8	3.8
18.0				3.0	3.3	3.6	2.6	3.0	3.3	2.7	3.1	3.5	2.6	3.0	3.4
20.0				2.2	2.5	2.7	1.9	2.2	2.5	2.0	2.3	2.7	2.0	2.3	2.7
22.0				1.7	1.9	2.1	1.4	1.6	1.8	1.4	1.8	2.1	1.4	1.7	2.1
24.0				1.3	1.5	1.6	0.9	1.2	1.3	1.0	1.3	1.6	1.0	1.3	1.6
26.0				0.9	1.1		0.6	0.8	0.9	0.7	0.9	1.2	0.6	0.9	1.2
28.0				0.6	0.8			0.5	0.5		0.6	0.8		0.6	0.8
30.0											0.5				0.5



m	10.4 m + 15.8 m			24.7 m + 15.8 m			28.3 m + 15.8 m			39.0 m + 15.8 m			41.0 m + 15.8 m		
	0°	20°	40°	0°	20°	40°	0°	20°	40°	0°	20°	40°	0°	20°	40°
3.0	5.4														
3.5	5.3														
4.0	5.1														
4.5	4.9														
5.0	4.8			4.9											
6.0	4.4			4.7			4.6								
7.0	4.1			4.5			4.5								
8.0	3.9	3.2		4.4			4.3								
9.0	3.6	3.0		4.2			4.2			3.4					
10.0	3.4	2.8		4.1			4.1			3.4			3.1		
11.0	3.2	2.7		3.9	2.9		3.9			3.4			3.1		
12.0	3.0	2.6	2.3	3.7	2.8		3.8	2.8		3.4			3.1		
14.0	2.7	2.3	2.1	3.4	2.6		3.5	2.6		3.3	2.6		3.1		
16.0	2.5	2.1	2.0	3.2	2.5	2.1	3.3	2.5	2.1	3.2	2.5		3.1	2.5	
18.0	2.2	2.0	1.9	3.0	2.3	2.0	3.0	2.4	2.0	2.9	2.4		2.8	2.3	
20.0	2.1	1.9	1.8	2.6	2.2	1.9	2.2	2.2	1.9	2.3	2.3	1.9	2.2	2.2	1.9
22.0	1.9	1.8		2.1	2.1	1.9	1.7	2.1	1.9	1.8	2.2	1.9	1.7	2.2	1.9
24.0				1.6	2.0	1.8	1.3	1.8	1.8	1.3	1.8	1.8	1.3	1.8	1.8
26.0				1.2	1.6	1.8	0.9	1.4	1.7	0.9	1.4	1.8	0.9	1.4	1.7
28.0				1.0	1.3	1.5	0.6	1.0	1.3	0.6	1.0	1.4	0.6	1.0	1.4
30.0				0.7	1.0	1.1		0.7	0.9		0.7	1.0		0.7	1.0
32.0				0.5	0.7	0.8		0.5	0.6		0.5	0.7		0.5	0.7
34.0					0.5						0.5				0.5

 Gegengewicht / Counterweight	1 x	2 x	3 x	1 x	1 x
	①	②	③	④	⑤
(t)	2.0	1.0	2.0	2.1	3.1

15.2t

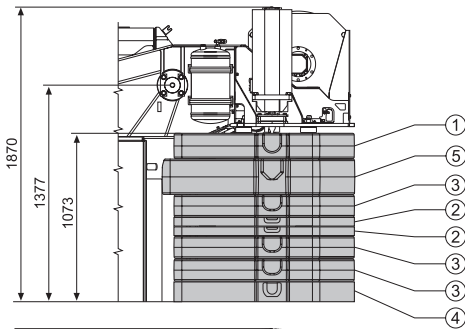

10.1t¹⁾

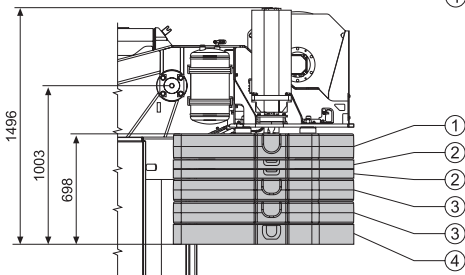

1) Zum Mitführen, nur mit spezieller Fahrgestellvariante /
To be included for traveling, only with specified chassis type

9.1t

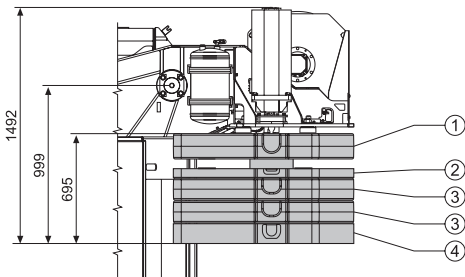

8.1t

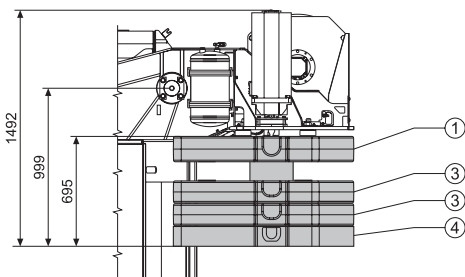

5.1t

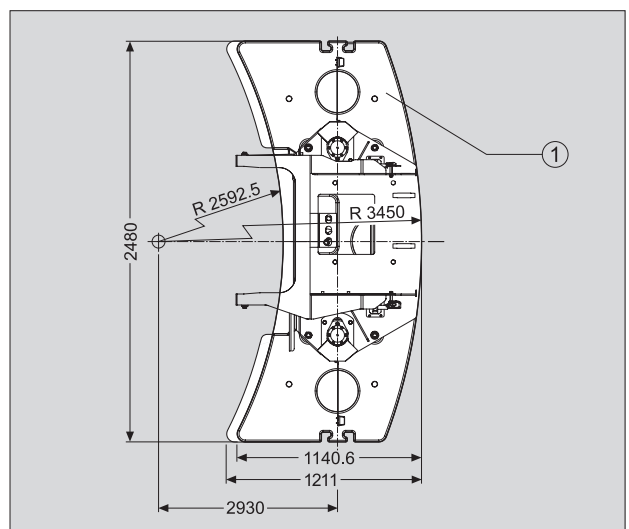
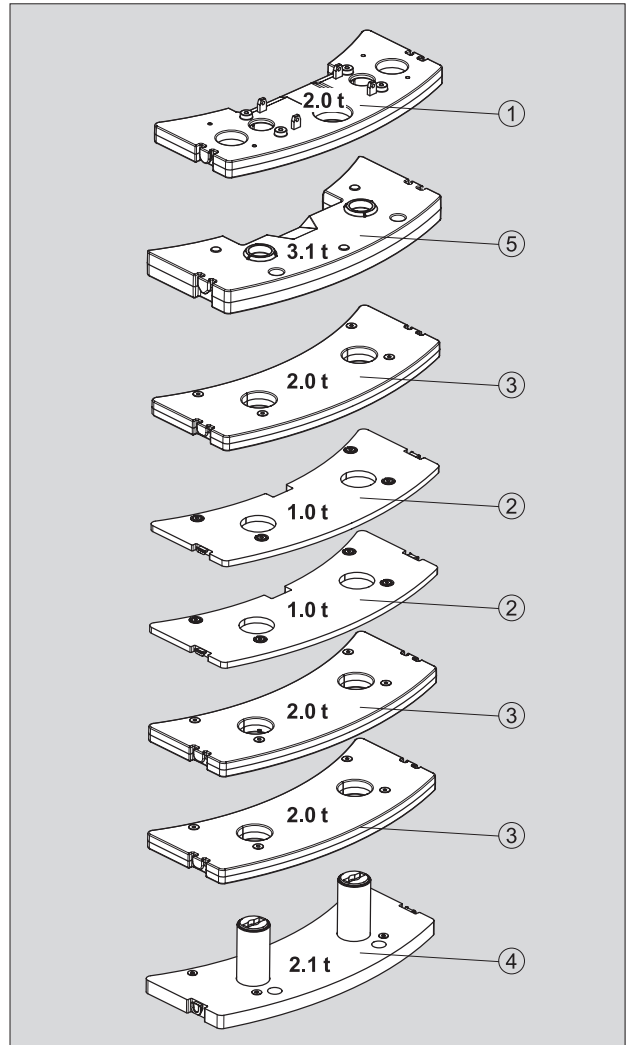
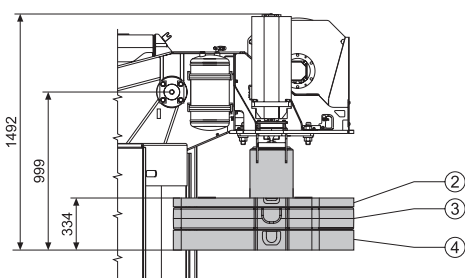

Ausrüstung



Fahrgestell Mindestanforderungen für 4-achsige Fahrgestelle der Marken
MAN 8 x 4,
SCANIA 8 x 4 und
Volvo 8 x 4 verfügbar.
Weitere Marken auf Anfrage.

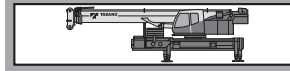

Hauptrahmen Verwindungs- und biegesteife Stahlkonstruktion aus hochfestem Feinkornstahl in Kastenbauweise mit Zwischenrahmen zur Befestigung am Trägerfahrzeug.

Abstützung Hydraulische, teleskopierbare 4-Punkt-Abstützung vorne schwenkbar, Bedienungsmöglichkeiten an beiden Seiten des Fahrgestelles und in der Oberwagenkabine.
Abstützbasis: längs - 6,94 m/ quer - 6,85 m.

Oberwagenrahmen Verwindungssteife Schweißkonstruktion mit einer außenverzahnten, einreihigen Kugeldrehverbindung, um 360° unbegrenzt drehbar.

Motor Mercedes-Benz 4-Zylinder-Dieselmotor OM 924 LA (Euromot III B), wassergekühlt. Drehzahl über Fußpedal stufenlos regelbar, Leistung 95 kW (129 PS) bei 2200 min⁻¹. Drehmoment 500 Nm (51 kpm) bei 1200 - 1600 min⁻¹. Motorleistung nach DIN 80 /1269 /EWG.
Kraftstoffbehälter 200 l. AdBlue-Behälter 8 l.

Hydraulik System Diesel-hydraulisch mit 3-Kreishydraulik, 1 leistungsgeregelte Axialkolbendoppelpumpe (hydraulisch verstellbar) und 1 Zahnrad-Doppelpumpe, Ölkühler.

Steuerung Zwei 4-fach Kreuzsteuerhebel mit elektrischer Vorsteuerung für gleichzeitige, voneinander unabhängige Kranbewegungen.

Teleskopausleger Fünfteiliger Teleskopausleger aus hochfestem Feinkornstahl, bestehend aus einem Grundausleger und 4 Teleskopteilen, 1 Teleskopzylinder, hydraulisch unter Teillast teleskopierbar. 10,4m - 41,0 m lang. Rollenkopf mit 6 Seilrollen.

Wipswerk Differentialzylinder mit angebautelem Senkbremssventil.

Hubwerk Axialkolben-Motor, Hubwerkstrommel mit eingebautem Planetengetriebe und federbelasteter Hydro-Lamellenbremse mit integriertem Freilauf beim Heben.
Hubseil mit 'Super-Stop' Einrichtung.

Drehwerk Axialkolben-Motor, zweistufiges Planetengetriebe mit fußbetätigter Betriebsbremse und Feststellung.
Drehgeschwindigkeit stufenlos von 0 - 2 min⁻¹.

Gegengewicht Standard ca. 9,1 t teilbar.
Die Bedienung erfolgt aus der Oberwagenkabine.

Oberwagenkabine Großräumige Krankabine in Stahl-Kunststoff-Ausführung, seitlich ausfahrbarem Trittblech, Sicherheitsverglasung und getönten Scheiben, kippbarem Arbeitsplatz mit verstellbarem, hydraulisch gedämpftem Fahrersitz, motorunabhängige Wasserheizung (mit Motor-Vorwärmung), Klimaanlage, Radio/CD-Player, Kontroll- und Bedienungselemente für Kranbetrieb.

Elektrische Anlage 24 V Gleichstrom, 2 Batterien.

Sicherheitseinrichtungen Lastmomentbegrenzung (LMB), Arbeitsbereichsbegrenzung, Hubendschalter, Windenendschalter, Seilwindendrehmelder, Sicherheitsventile gegen Rohr- und Schlauchbrüche. Sperrventile an Hydraulik-Zylindern.

Zusatzausrüstung (gegen Mehrpreis)
'Lift Adjuster', Auslegerverlängerung 8,8 m/15,8 m, abwinkelbar 0°, 20° und 40°, Zusatzgegengewicht 1 t für insgesamt 10,1 t bzw. 6,1 t für insgesamt 15,2 t, LMB-Erweiterung für zusätzliche Lasttabellenvariante, 6 t Hakengeschrir, verschiedene Unterflaschen, Drehbereichsbegrenzung, Zusatzölkühler, Zentralschmieranlage, Sonderlackierung und Beschriftung.
Weitere Zusatzausrüstung auf Anfrage.

Anmerkungen zu den Traglasttabellen

Die Tragfähigkeiten im Festigkeitsbereich basieren auf DIN 15018 Teil 3 / F.E.M. / EN 13000.

Die Tragfähigkeiten im Standsicherheitsbereich entsprechen DIN 15019 Teil 2 / ISO 4305 / EN 13000.

Die zulässige Windgeschwindigkeit beträgt maximal 15 m/s am Hauptausleger und 7 m/s an der Hauptauslegerverlängerung.

Die Tragfähigkeiten sind in metrischen Tonnen angegeben.

Das Gewicht des Lasthakens bzw. der Hakenflasche und weiterer Anschlagmittel ist von der Tragfähigkeit abzuziehen.

Die Tragfähigkeiten für den Teleskopausleger gelten nur bei demontierter Auslegerverlängerung.

Die Ausladung ist der horizontale Abstand von Mitte Drehkranz bis Mitte freihängender, nicht schwingender Last.

Tragfähigkeitsänderungen vorbehalten.

*Obige Angaben dienen nur zur Information.
Die Bedienungsanleitungen müssen zu Rate gezogen werden, bevor die Maschine in Betrieb genommen wird. Alle hier gemachten Angaben beziehen sich auf die Standard-Ausführung.
Jegliche Ausrüstungsveränderungen können die angegebenen Werte beeinflussen.*



Chassis Requirements for 4 axle chassis make of MAN 8 x 4, SCANIA 8 x 4 and Volvo 8 x 4 available.

Other chassis on request.

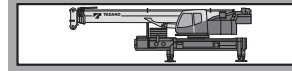

Main frame Torsion-resistant, steel construction made from high strength, fine-grained steel. Specially designed with intermediate frame for the type of chassis selected.

Outriggers Hydraulically extendable 4 point outriggers front slewable with controls on both sides of carrier and in superstructure cab.
Outrigger base - 6.94 m/crosswise - 6.85 m.

Frame Torsion-resistant all-welded structure with a single-row ball slewing ring with external gearing for 360° continuous rotation.

Superstructure engine Mercedes-Benz 4 cylinder model OM 924 LA (Euromot III B), water cooled, diesel engine. Engine speed infinitely controlled via pedal. Rated at 95 kW (129 HP) at 2200 min⁻¹. Torque 500 Nm (51 kpm) at 1200 - 1600 min⁻¹. Engine rating according to 80/1269/EWG. Fuel tank 200 l. AdBlue-tank 8 l.

Hydraulic system Three circuit diesel hydraulic system with 1 power controlled axial piston double pump (hydraulically adjustable) and 1 double gear pump, oil cooler.

Controls Electrical, 2 joy-stick levers for simultaneous and independent operation of 4 crane motions.

Telescopic boom 5 sections, made of high tensile, fine-grained steel, consisting of 1 base section and 4 telescoping sections extended by means of a single telescopic cylinder. All telescope sections extendable under partial load. 10.4 m to 41.0 m long. Boom head with 6 sheaves.

Derricking system 1 differential hydraulic cylinder with integral brake and holding valve.

Main winch Axial piston motor, winch drum with integrated planetary reduction and with hydraulically controlled spring-loaded, multiple disc brake and with integrated free rotation (no sagging of load when hoisting).
Hoist cable with 'Super-Stop' easy reeving system.

Slewing system Axial piston motor with two-stage planetary reduction with a foot actuated service and a parking brake. Speed infinitely variable 0 - 2 min⁻¹.

Counterweight Standard approx. 9.1 t divisible, assembled and disassembled by hydraulic cylinders controlled from superstructure cab.

Superstructure cab Spacious panoramic cab of composite structure, slewable side step, safety (tinted) glass windows, tiltable cockpit with hydraulically cushioned adjustable seat, engine independent water heater (with engine pre-heat), air conditioning, radio/CD-player, complete controls and instrumentation for crane operation.

Electrical system 24 volt DC system, 2 batteries.

Safety devices Load moment device (LMD), working area limiter, hoist limit switch, lower limit switch, drum turn indicator, safety valves against pipe and hose rupture. Holding valves on hydraulic cylinders.

Optional Equipment (at extra charge)
'Lift Adjuster', boom extension 8.8 m/ 15.8 m long, offsets 0°, 20° and 40°, additional counterweight 1 t for total 10.1 t, respectively 6.1 t for total 15.2 t, LMD-programme for additional load charts, 6 t swivel hook, selection of hook blocks, slewing area limitation, additional oil cooler, central lubricating system, special painting and lettering.
Further optional equipment available upon request.

Remarks concerning the load charts

The lifting capacities in the structural area are based on DIN 15018 part 3 / F.E.M. / EN 13000.

The lifting capacities in the stability area are based on DIN 15019 part 2 / ISO 4305 / EN 13000.

The maximum permissible wind speed for crane operation is 15 m/s for main boom and 7 m/s for the boom extension.

The lifting capacities are shown in metric tons.

The weight of load handling devices such as hook blocks, slings, etc., must be considered as part of the load and must be deducted from the lifting capacities.











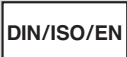
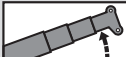

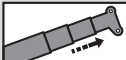

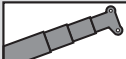
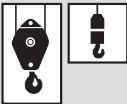
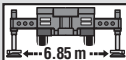



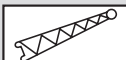

The lifting capacities for the telescopic boom apply to a crane with no boom extensions being stowed or mounted on the crane.

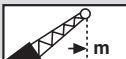
The working radius is the horizontal distance from the centre of rotation to the centre of the freely suspended non-oscillating load.

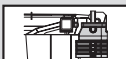
The lifting capacities are subject to change without prior notice.

The above remarks are for basic information only and the operator's manual must be consulted before operating this crane. All data and performances refer to the standard crane. The addition of optional and other equipment may affect the performance of the crane.

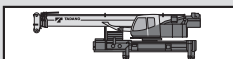
Symbolerklärung
Symbols

	Siehe Seite 16 As on Page 17		Wippwerk Derricking system
	Räder / Größe Tyres / Size		Teleskopieren Boom telescoping
	Achslast Axle load		Teleskopausleger Telescopic boom
	Unterflasche / Hakengeschirr Hook block / Swivel hook		Abstützung Outriggers
	Geschwindigkeiten Unterwagen Carrier speeds		Gegengewicht Counterweight
	Getriebe / Gang Transmission / Gear		Ausladung Radius
	Steigfähigkeit Gradeability		Auslegerverlängerung Boom extension
	Gelände Off road		Ausladung Radius
	Straße On road		Gegengewichtvarianten Counterweight versions
	Geschwindigkeiten Oberwagen Superstructure speeds		Unterwagen Carrier
	Hubwerk Main winch		Oberwagen Superstructure
	Drehwerk Slewing system		



A large grid area for taking notes, consisting of a grey background with a white grid pattern.



TADANO FAUN GmbH

Faunberg 2, 91207 Lauf a. d. Pegnitz, Germany
Phone: +49-9123-185-0 Fax: +49-9123-3085
<http://www.tadanofaun.de> E-mail: info@tadanofaun.de

TADANO LTD. (International Division)

4-12, Kamezawa 2-chome, Sumida-ku Tokyo 130-0014, Japan
Phone: 81-3-3621-7750 Fax: 81-3-3621-7785
<http://www.tadano-global.com> E-mail: tdnihq@tadano.co.jp