

Link-Belt®

LS-338

Wire Rope Crawler Crane/Excavator

100-ton (90.7 metric ton)

GENERAL INFORMATION ONLY



Exclusive FMC Full-Function revolving upperstructure design

Permits independent swing, travel, boomhoist and hoist

GENERAL INFORMATION ONLY

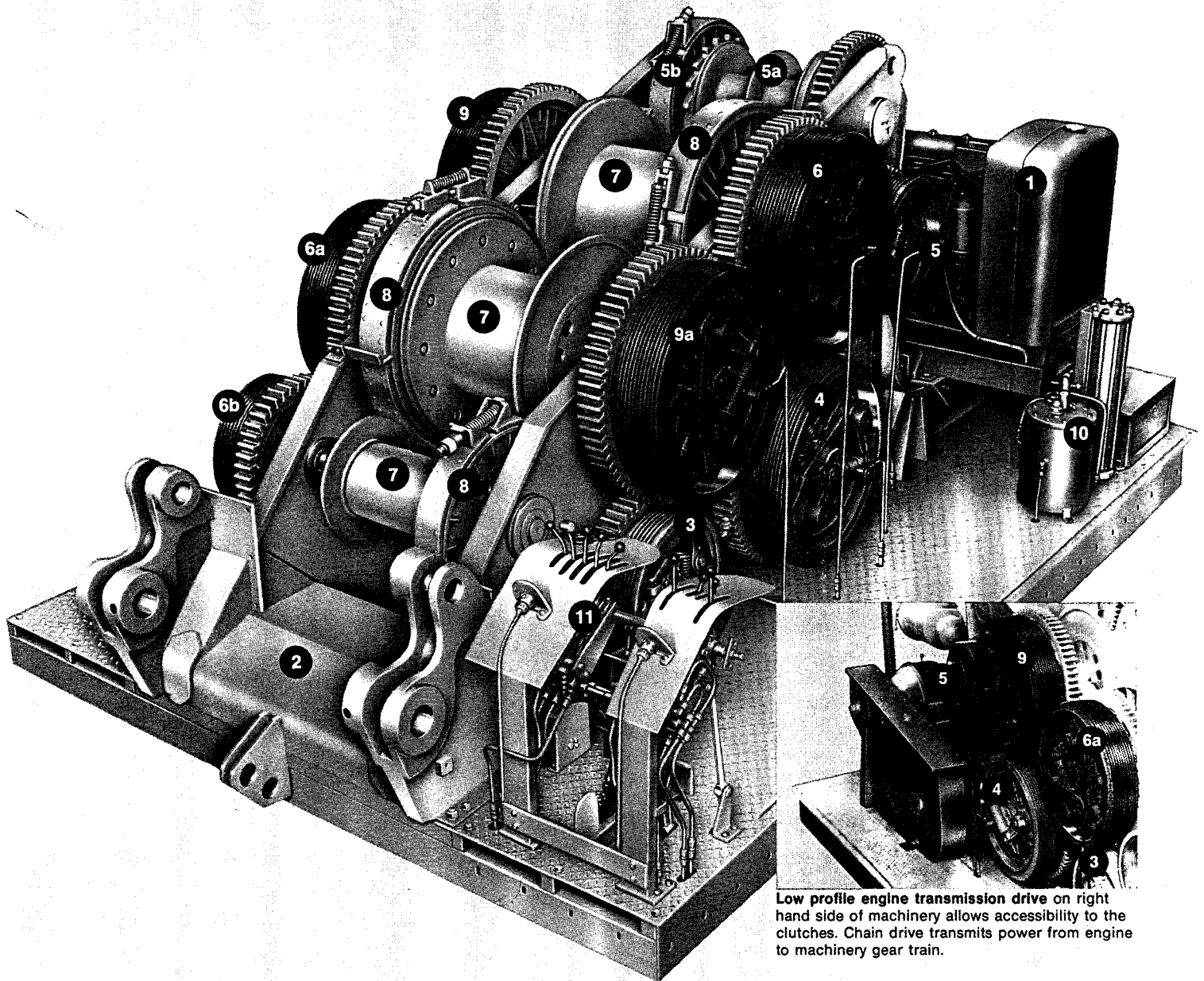

Low profile engine transmission drive on right hand side of machinery allows accessibility to the clutches. Chain drive transmits power from engine to machinery gear train.

- 1 Engine:** Diesel with torque converter.
- 1a Auxiliary output shaft governor control** (optional) for lifting crane service, allows increase of hoist line speed up to 150% when line pull is less than maximum. (See page #3.)
- 2 Frame:** Fixture welded and stress relieved for strength and durability; line bore accuracy for proper shaft and gear alignment. Results in less component wear and lower maintenance costs.
- 3 Travel:** Independent. Two-shoe clutches transmit travel power smoothly into the track sprockets.
- 4 Swing:** Independent. Extraordinary size 2-shoe clutches transmit swing power smoothly into the vertical swing shaft and pinion.
- 5 Boomhoist:** Independent. Gear driven with 2-shoe clutches for boom raising and lowering of the boom.
- 5a Boomhoist rope drums:** One-piece, dual drum with integral ratchet wheel splined to shaft. Manually controlled pawl may be engaged to lock ratchet wheel and drum in lowering direction.
- 5b Boomhoist rope drum brake:** Automatically spring applied, power hydraulically released.
- 6 6a, 6b Hoist clutches:** Two-shoe, rear drum (6), front drum (6a) and optional third drum (6b).
- 7 Rope drum laggings:** Rear, front and optional third drum bolted to brake drum. Grooved laggings available for duty cycle application on main drums.
- 8 Drum brakes:** Mechanically operated by foot pedals. Drum brakes separated from clutches (item 6, 6a, and 6b) to eliminate heat transfer, resulting in cooler brakes and clutches for longer component life of both. Brake drums splined to drum shafts.
- 9 9a Power load lowering clutches:** (Optional) independent front and rear drum 2-shoe clutches for powering down light loads and controlled lowering of heavier loads.
- 10 Power package for power hydraulic controls:** Vane-type pump, belt driven from engine, piston-type accumulator and sump tank; normal system operating pressure, 900 (6,205.50 kPa) to 1050 (7,239.75 kPa) p.s.i.
- 11 Control console:** Exclusive Speed-o-Matic® power hydraulic controls; time-tested and proven throughout the world.

Exclusive Speed-o-Matic® power hydraulic control system

For superb control of all machine functions

GENERAL INFORMATION ONLY

The model LS-338 Link-Belt® crawler crane was designed for stability and strength with less overall weight. The revolving upperstructure machinery design is FMC's unique Full-Function design. This exclusive machinery design permits independent or simultaneous performance of swing, travel, booming and load hoisting or lowering. Increases on-the-job machine and load handling capability.

For superb control of all the machine functions, the LS-338 Link-Belt crawler crane incorporates the exclusive Speed-o-Matic® power hydraulic control system. This system is unaffected by day-to-day atmospheric variations and does not require priming or bleeding. Oil under pressure from the belt-driven, vane-type pump or from the pressure accumulator storage tank does the work. Normal system operating pressure is 900 (6,205.50 kPa) — 1050 (7,239.75 kPa) p.s.i. The accumulator is pre-charged to 650 (4,481.75 kPa) p.s.i.

Short throw levers in **operator's control console** actuate variable pressure control valves which direct oil under pressure to each 2-shoe clutch for prompt, positive response. Speed-o-Matic® power hydraulics . . . the exclusive control system that permits the use of 2-shoe clutches for all machine functions.

The power hydraulic, 2-shoe clutch is self-compensating over a wide range of lining wear and heat expansion and is separated from the rope drum brake to eliminate heat transfer for longer clutch and brake lining life.

The diesel engine with single stage **torque converter** is standard. Three stage converter, optional.

The torque converter drive gives the operator flexibility of operation, plus allows for smooth acceleration and deceleration of swing, travel, hoist, and boom. With hoist clutch engaged and



Operator control console

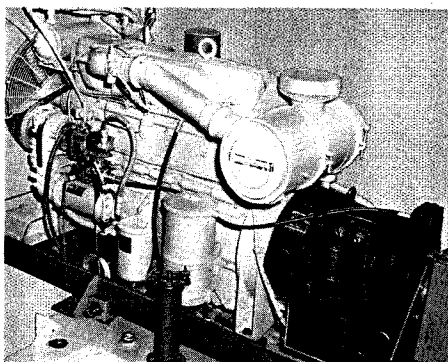

Torque converter

the torque converter drive it is possible to (1) hoist the load (2) partially retard engine throttle and "hold" the load, or (3) further retard the throttle and lower the load against the converter.

With the torque converter it is possible to develop greater torque (boomhoist and load line pull) at decreased engine r.p.m. This results in optimum control of swing, delicate lifts and long boom/jib lift-off.

The torque converter auxiliary output shaft governor manual control is

optional. When hoisting loads requiring less than maximum hoist line pull, the operator engages a manual control located to his right. This opens up the converter governor, which in turn opens up the diesel engine governor. This will increase the engine r.p.m. to its maximum setting, speeding up the machinery gear train for greater hoist line speed. This arrangement allows up to 150% increase in hoist line speed for greater machine productivity. In addition, combined with the optional high speed planetary driven rope drum (see page #7) the total result is up to a maximum of 255% higher than standard hoist line speed, with line pull up to approximately 8000# (3,629 kg).

LS-338 features removable crawler side frames for fast stripdown

FMC patented wedgepack design secures frames to cross axles

GENERAL INFORMATION ONLY

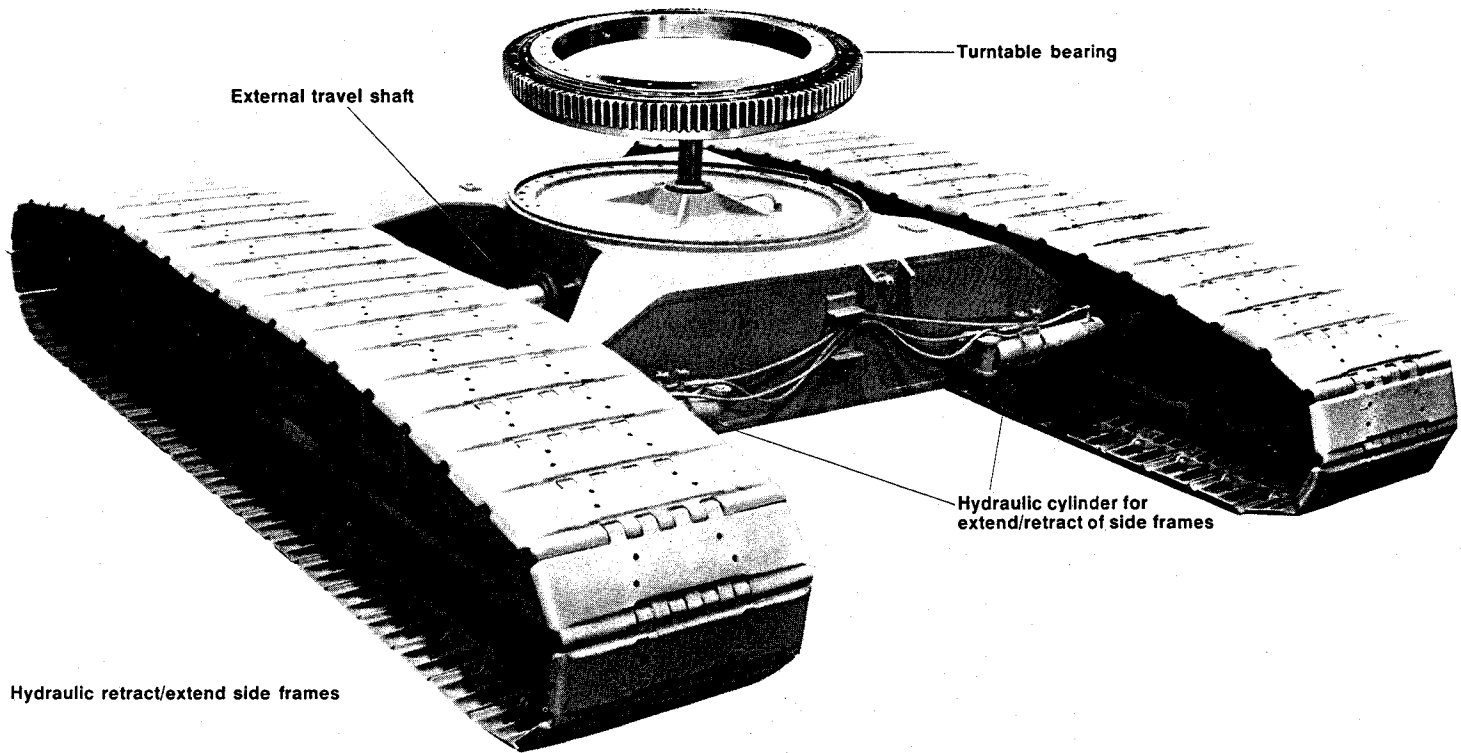

Hydraulic retract/extend side frames

The LS-338 lower and side frames are all welded and stress relieved to provide a more durable working base. The lower frame is then machined and line bored for mounting of the center horizontal travel shaft. The **external horizontal travel shaft** is spline connected to both the center travel shaft located in the lower frame and the drive chain sprocket hub located in the side frame. When removing side frames, external travel shafts are stored in the drive sprocket hub. The drive chains remain intact.

The side frames are positioned to the lower frame cross axles by a dowel fixed in the bottom of each side frame window. The dowel fits in circular recess on underneath side of cross axle. A **wedgepack (A)** is then placed above each cross axle inside the window of the side frame. By means of a **tie bolt**, the wedge is drawn up the inclined plane, locking each side frame to its respective

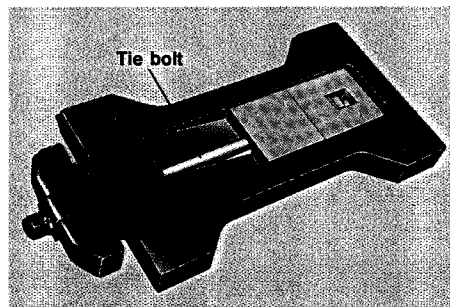

Wedgepack (A)

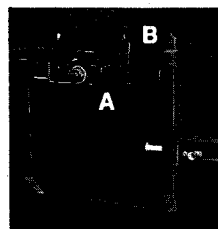

Wedgepack in position

cross axle. End plate (B) secures **wedgepack in position**. An FMC patented feature.

For fast stripdown (or assembly) **side frames can be hydraulically**

extended or retracted, with hydraulic power from the power hydraulic steer system.

Track shoes and rollers are heat treated to minimize track wear. Chain/track sprocket, track idler roller, and track rollers are mounted on bronze bushings.

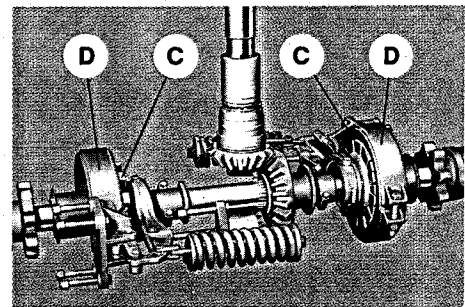

Power hydraulic steer

Power hydraulic steer is standard. Jaw clutches (C) are operator engaged through power hydraulics. When jaw clutches are fully engaged, or preloaded, spring applied brakes (D) are automatically released. Jaw clutches (C) are engaged independently for steer by either of two operator steer control levers. They are simultaneously engaged for straightline travel by the two steer levers. Brakes (D) also serve as holding brakes while working.

The crane upper is mounted to the crawler lower by a **turntable bearing** which provides extremely smooth swinging.

Angle boom to 80' (24.38m) for dragline/ clamshell/magnet/grapple operation

150' (45.72m) boom plus 40' (12.19m) jib for lifting crane service

GENERAL INFORMATION ONLY

The LS-338 with extraordinary size swing clutches (Item 4, page 2), plus the strength and size of all the machinery components is ideal for excavator and duty cycle service.

The angle boom is bolt-connected with quality-built box lattice construction, with alloy chord angles. Basic boom is 2-piece, 50' (15.24m) in length. Boom extensions of 10' (3.05m), 15' (4.57m), 20' (6.10m), and 30' (9.14m) are available.

The **full-revolving fairlead** rotates to insure rope support in all positions. All

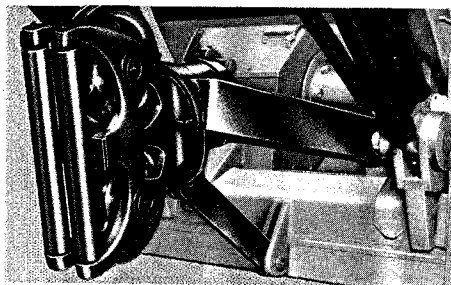

Full revolving fairlead

moving parts are mounted on anti-friction bearings. Increases inhaul rope life; permits greater economy.

Four sheaves are available for lifting crane operation.

Dual, rail-type **boom stops**, each with spring loaded bumpers, are standard.

As a lifting crane, the LS-338 with **live mast** handles up to 150' (45.72m) of angle boom plus 40' (12.19m) angle jib. The live mast is required for angle booms exceeding 100' (30.48m) and for boom exceeding 50' (15.24m) when equipped with jib. The basic angle jib is 2-piece, 20' (6.10m) in length, with 10' (3.05m) and 15' (4.57m) jib extensions available.

Boom angle indicator is standard with the angle boom (see photo page #6).

For dragline, clamshell, and grapple operation, the **angle boompoint** is available with two wide flange sheaves along with roller-type hoist rope guard for increased rope and sheave life. Sheaves and guard rollers are mounted on anti-friction bearings.

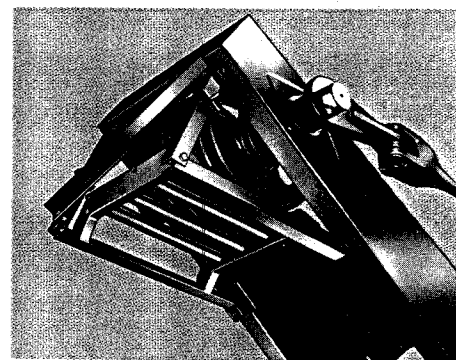

Angle boompoint

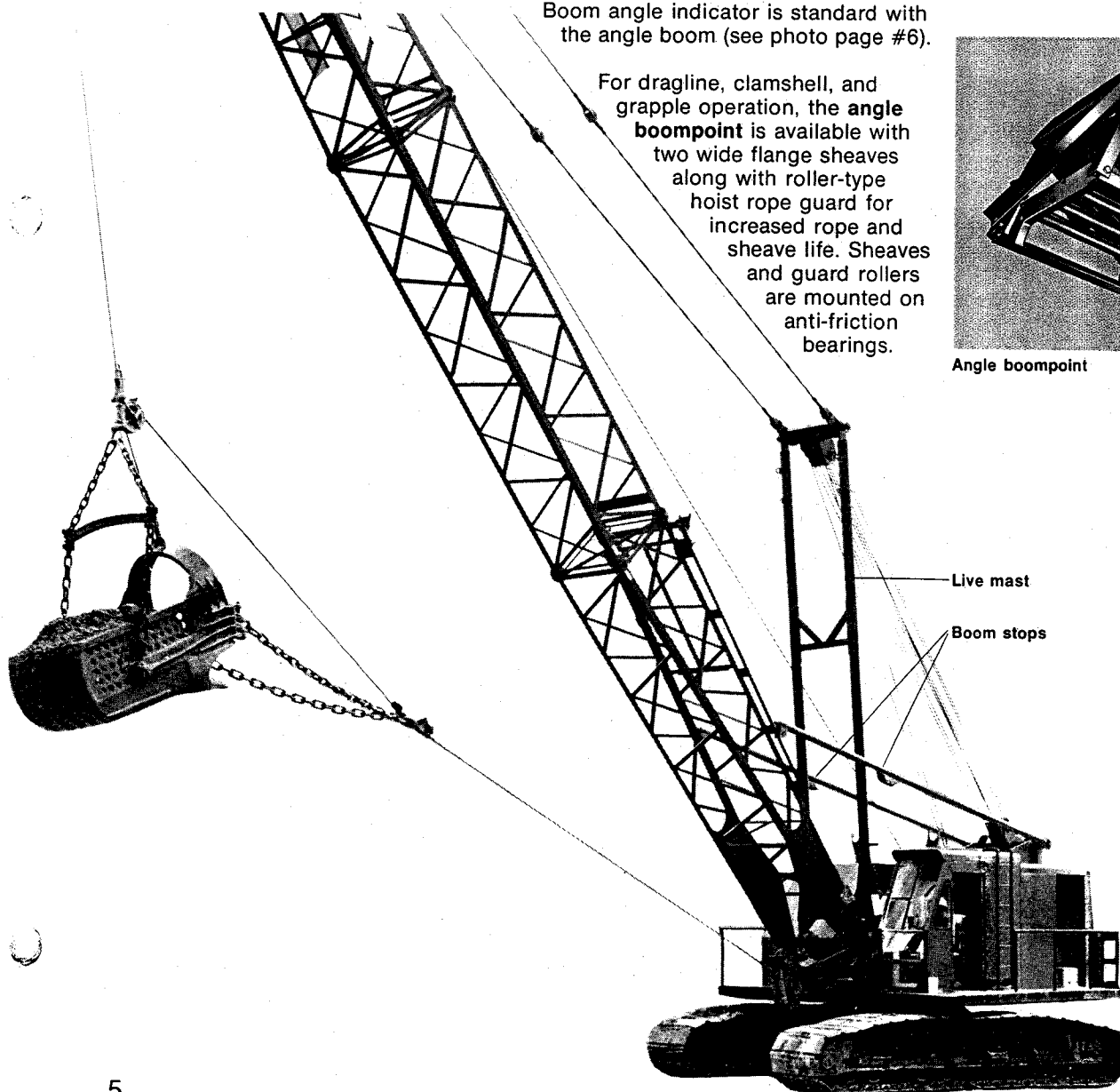

Live mast

Boom stops

Tubular boom and jib for crane/ dragline/clamshell/grapple operation

GENERAL INFORMATION ONLY

Up to 200' (60.96m) boom or 180' (54.86m) boom + 60' (18.29m) jib for crane service

The LS-338 crawler crane can be equipped with a tubular boom and jib. The basic boom is 50' (15.24m), 2-piece pin-connected with 10' (3.05m), 20' (6.10m), 30' (9.14m), and 40' (12.19m) extensions available up to a maximum length of 200' (60.96m) for lifting crane service. Also available is a 2-piece, 30' (9.14m) jib, pin-connected with 10' (3.05m) and 15' (4.57m) extensions available for a maximum jib length of 60' (18.29m).

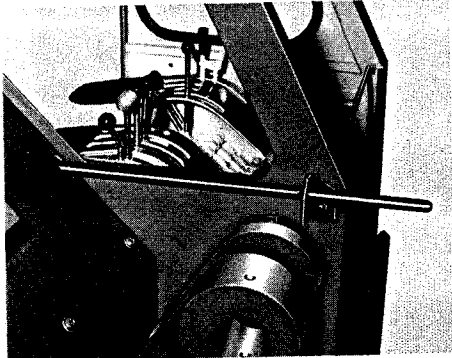

Boomhoist limiting device

The **boomhoist limiting device** improves close-radius operation. When an attempt is made to raise the boom closer than minimum radius, this mechanism acts to disengage the boom raising clutch and simultaneously engage the boomhoist brake.

The method of welding the **in-line pin lugs** to the round chord tube minimizes stress concentration and is an exclusive development of FMC engineering/manufacturing technology. The extended hub on the female connection serves as an anchor for the jib backstays or for pendant lines when assembling the boom. The tapered end pin is held in place with two latch pins.

The standard **boom angle indicator** serves as a handy guide to the operator. It is mounted on the side of the boom nearest the operator for his ready reference.

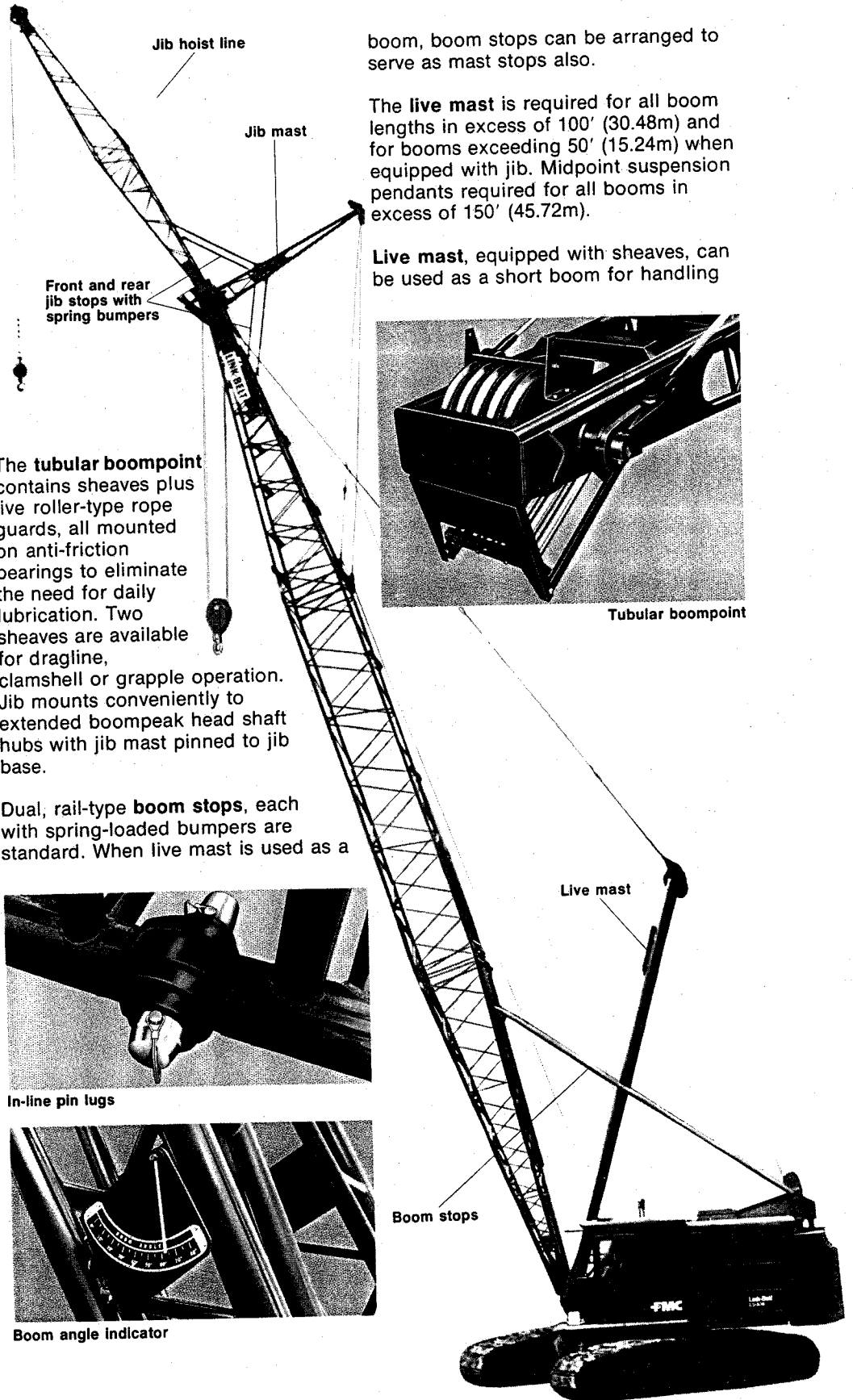

boom, boom stops can be arranged to serve as mast stops also.

The **live mast** is required for all boom lengths in excess of 100' (30.48m) and for booms exceeding 50' (15.24m) when equipped with jib. Midpoint suspension pendants required for all booms in excess of 150' (45.72m).

Live mast, equipped with sheaves, can be used as a short boom for handling

The **tubular boompoint** contains sheaves plus five roller-type rope guards, all mounted on anti-friction bearings to eliminate the need for daily lubrication. Two sheaves are available for dragline, clamshell or grapple operation. Jib mounts conveniently to extended boompeak head shaft hubs with jib mast pinned to jib base.

Dual, rail-type **boom stops**, each with spring-loaded bumpers are standard. When live mast is used as a

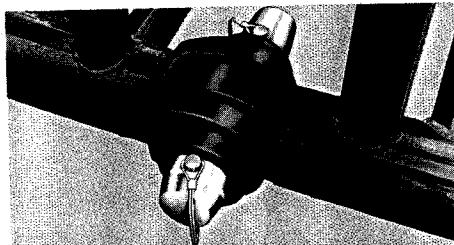

In-line pin lugs

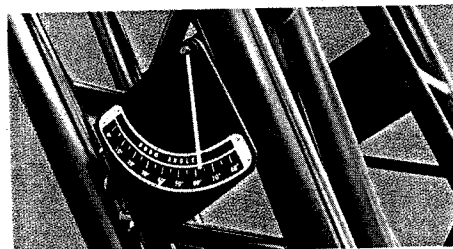

Boom angle indicator

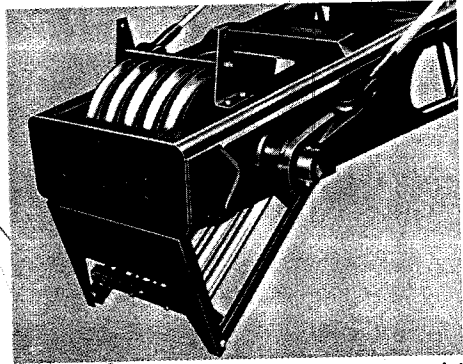

Tubular boompoint

side frames, boom sections and counterweight when dismantling or assembling the machine.

The **counterweight** is quickly raised or lowered with rope mechanism (optional). The **rope drum** is splined to the boom hoist drum shaft. The counterweight is lowered with the boomhoist brake and raised with the boomhoist clutch. Permits fast, 1-piece raising or lowering of the counterweight.

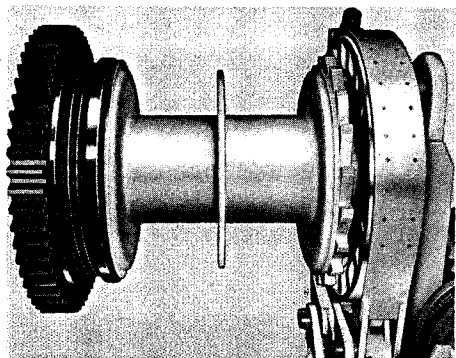

Counterweight raising/lowering rope drum

The **swing brake** is spring applied or power hydraulically released (under control of the operator). Acts to hold upper and boom at any swing position or it can be partially engaged for a slight drag to control side drift when making precision lifts. Swing brake is controlled from operator's position through variable pressure control valve. The LS-338 features a mechanical swing lock as standard equipment.

For high-speed hoisting, an exclusive **independent planetary hoist** arrangement (optional) can be mounted

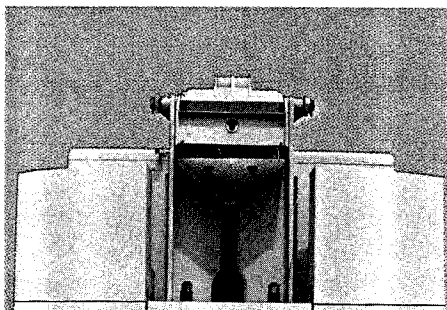

Counterweight raising/lowering

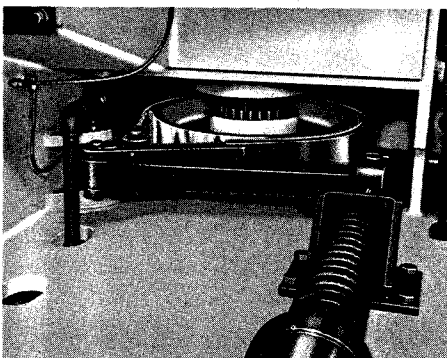

Swing brake

between the drum gear and clutch drum. The planetary arrangement can provide up to 70% increased hoisting speed. Engaging the 2-shoe clutch provides standard hoist rope speed; planetary brake is controlled by push button on hoist control lever.

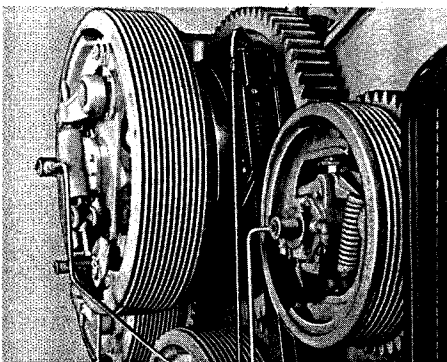

Independent planetary hoist

Catwalk and railing along operator's side, or both sides, of cab are available (optional).

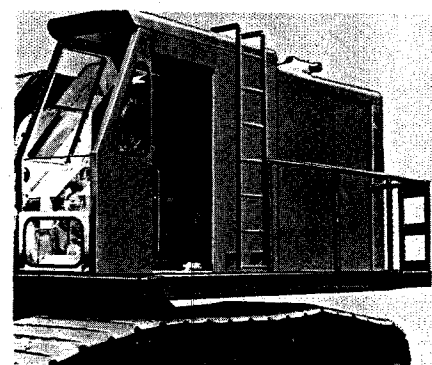

Catwalk and railing

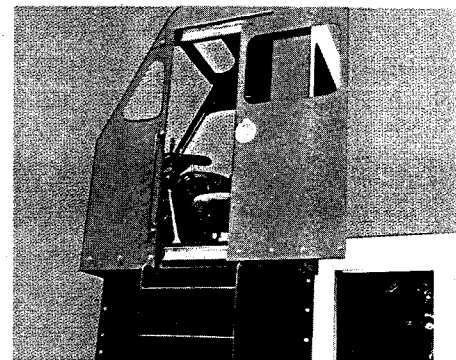

Elevated operator's cab

Elevated operator's cab is available. This option puts the operator up where he can see his work on specialized loading jobs. The result is greater speed of operation with improved visibility.

The flexibility of the machine design results in the availability of options, all designed to maximize the usefulness and productivity of the machine, unmatched by competitive crawler cranes.

GENERAL INFORMATION ONLY

The LS-338 crawler crane features

*self-erecting/stripdown of side frames and boom
self-installation/removal of counterweight*

The LS-338 crawler lifting crane is designed for fast, on-the-job self-erection or self-stripdown of boom, counterweight and side frames. No need for auxiliary crane equipment. The basic procedure in brief is as follows: (Exact details on LS-338 self-stripdown are available upon request.)

1. Counterweight is lowered to the ground with rope mechanism. (See page 7.) Machine handles counterweight.
2. Remove plate (not shown) from end of external horizontal travel shaft (A). Pull shaft (A) from the splined coupling (B) in lower frame and store in the hub of the chain sprocket.
Loosen wedgepack (A) tie bolt, (see page 4) remove end plate (B) and remove wedgepack (A).
3. Raise and block under lower frame, and connect front and rear hydraulic cylinder rod end into side frame anchor (only front cylinder visible). Hoist chains anchored to track shoes.
4. With hydraulic power from the power hydraulic steer system, the side frame is extended.
5. Cylinder rod ends are freed from the cross axles. External travel shaft remains with side frame.
6. The LS-338 handles the side frame.

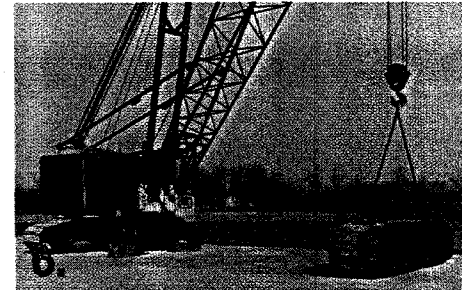
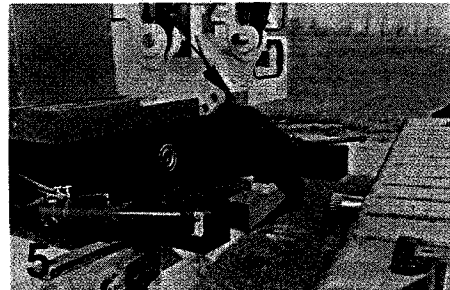
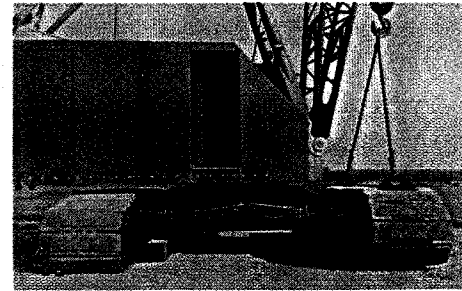
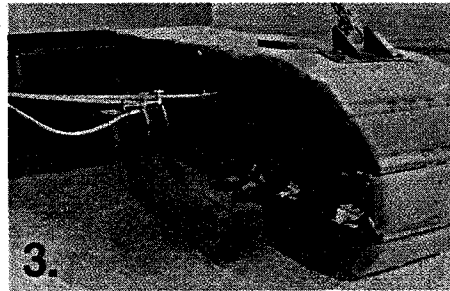
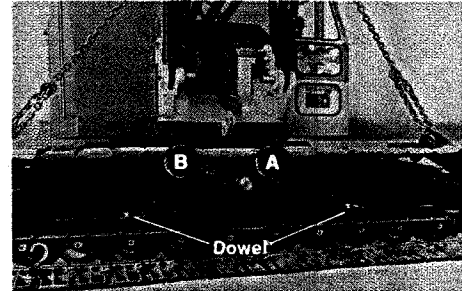
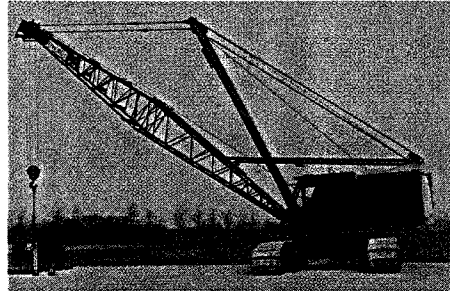

The LS-338 features

* FMC exclusive Full-Function gear train design.

Benefit – Permits independent crane functions for greater job flexibility.

* FMC exclusive Speed-o-Matic® power hydraulic control system.

Benefit – Dependable, proven, and eliminates daily maintenance.

* FMC patented cross axle to side frame wedgepack design.

Benefit – Permits faster stripdown/assembly of side frames.

* FMC exclusive, independent planetary high-speed hoisting/lowering of loads.

Benefit – Greatly increases machine productivity.

* Power hydraulic 2-shoe clutches, all mounted outside of side frames.

Benefit – Service accessibility, smooth acceleration/deceleration of swing, hoist and boomhoist.

* Power boom raising and lowering.

Benefit – More precise boom control.

* Main frames fixture welded, stress relieved, line bore accuracy.

Benefit – Greater strength and durability. Results in less component wear and lower maintenance cost.

* Tubular boom with chord members 100,000 p.s.i. high-strength alloy steel.

Benefit – More durable boom.

GENERAL INFORMATION ONLY

We are constantly improving our products and therefore reserve the right to change designs and specifications.

FMC Corporation Crane and Excavator Division World Headquarters Cedar Rapids Iowa 52406

Plants in: Cedar Rapids Iowa (2) • Lexington & Bowling Green Kentucky • Ontario Canada • Milan Italy • Queretaro Mexico & Nagoya Japan (under license)