

# GR-1450EX



Crane capacity :  
**145,000 kg at 2.5 m**

6-section long boom :  
**13.1 m - 61.0 m**

2-staged bi-fold jib :  
**10.3 / 18.0 m**

Maximum lifting height :  
**61.3 m ( Boom )**  
**78.2 m ( Hydraulic Offset Jib )**  
**78.4 m ( Manual Offset Jib )**

Maximum load radius :  
**56.0 m ( Boom )**  
**64.0 m ( Hydraulic Offset Jib )**  
**64.9 m ( Manual Offset Jib )**

# MODEL : GR-1450EX

## SPECIFICATIONS

MAXIMUM CAPACITY	145,000 kg at 2.5 m
PERFORMANCE	
Max.traveling Speed (with counterweight)	15 km/h
Gradeability (tan $\theta$ ) (with 18.2t counterweight)	52 % (at stall) $\approx$ 30 % $\approx$ Machine should be operated within the limit of engine crankcase design (17": MITSUBISHI 6M60-TL).
WEIGHT	
Gross vehicle mass	91,154 kg $\approx$ 90,805 kg $\approx$ Manual offset jib
-1st axle	29,398 kg $\approx$ 28,701 kg
-2nd axle	30,640 kg $\approx$ 30,814 kg
-3rd axle	31,116 kg $\approx$ 31,290 kg
MIN.TURNING RADIUS	14.9 m (2-wheel steering) 9.9 m(6-wheel steering) (at center of extreme outer tire)
BOOM	6-sections extended by single telescoping cylinder.
Fully retracted length	13.1 m
Fully extended length	61.0 m
Extension speed	47.9 m in 450 s
Elevation speed	20° to 60° in 28 s
JIB	Two staged slewing around boom extension; • Offset angle (5°-40°) by tilt cylinder. • * Triple offset (0°/20°/40°) type.
Length	10.3 m and 18.0 m $\approx$ Manual offset jib
MAIN WINCH	Variable speed type with grooved drum driven by hydraulic axial piston motor.
Single line pull	70.6 kN {7,200 kgf}
Single line speed	136 m/min. (at the 4th layer)
Wire rope	19 mm (diameter)
AUXILIARY WINCH	Variable speed type with grooved drum driven by hydraulic axial piston motor.
Single line pull	70.6 kN {7,200 kgf}
Single line speed	136 m/min. (at the 4th layer)
Wire rope	19 mm (diameter)
SLEWING SPEED	1.3 min <sup>-1</sup> {rpm}
Tail swing radius	4,600 mm
HYDRAULIC SYSTEM	Pumps... 2 variable piston pumps for crane functions. Tandem gear pump for steering, slewing and optional equipment. Control valves.... Multiple valves actuated by pilot pressure with integral pressure relief valves. Circuit... Equipped with air cooled type oil cooler. Oil pressure appears on AML display for main circuit. Hydraulic oil tank capacity... approx. 763 liters Filters.... Return line filter

TADANO Automatic Moment Limiter (Model: AML-C)	Main unit in crane cab gives audible and visual warning of approach to overload. Automatically cuts out crane motions before overload. With working range (load radius and/or boom angle and/or tip height and/or swing range) limit function. Automatic Speed Reduction and Slow Stop function on boom elevation and slewing. Following functions are displayed. • Load as percentage • Number of parts of line of rope • Boom angle • Boom length • Load radius • Outriggers position • On-tire indicator • Actual hook load • Permissible load • Boom position indicator • Potential hook height • Slewing angle • Main hydraulic oil pressure • Jib length and jib offset angle (only when jib in operation)
OUTRIGGERS	Hydraulically operated H-type outriggers. Each outrigger controlled simultaneously or independently from the cab. Equipped with sight level gauge. Floats can be stowed on vertical cylinders or removed to improve approach and departure angles. All cylinders fitted with pilot check valves. Crane operation with different extended length of each outrigger. Equipped with extension width detector for each outrigger. Outrigger unit is self-removable for ease of transportation.
Extended width	Fully ... 8,200 mm, Middle ... 7,300 mm & 5,500 mm Minimum ... 2,990 mm, Float size (diameter) ... 570 mm
CARRIER	Rear engine, left-hand steering, driving axle 2-way selected type by manual switch. 6 x 2 1st drive, 6 x 4 1st and 3rd drive
ENGINE	Model..... MITSUBISHI 6M60-TL Type .....4 cycle, turbo charged and after cooled, 6 cylinder in line, direct injection, water cooled diesel engine. Piston displacement...7,540 cm <sup>3</sup> Max.output...200 kW at 2,600 min <sup>-1</sup> {rpm} Max.torque ...785 N-m at 1,400 min <sup>-1</sup> {rpm}
TRANSMISSION	Electronically controlled full automatic transmission.
STEERING	Hydraulic power steering controlled by steering wheel. 4 steering modes available: 2-wheel front, 4-wheel rear 6-wheel coordinated, 6-wheel crab
SUSPENSION	1st..... Rigid mounted to the frame. 2nd, 3rd....."Hydro-Pneumatic suspension cylinders" with leveling adjustment and oscillation.
TIRES	26.5R25☆☆, Air pressure: 650kPa
FUEL TANK CAPACITY	300 liters

## WORKING RANGE

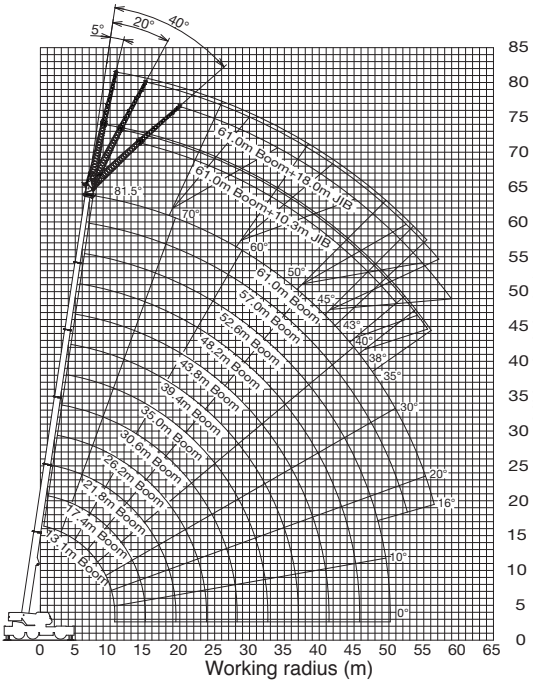

## DIMENSION

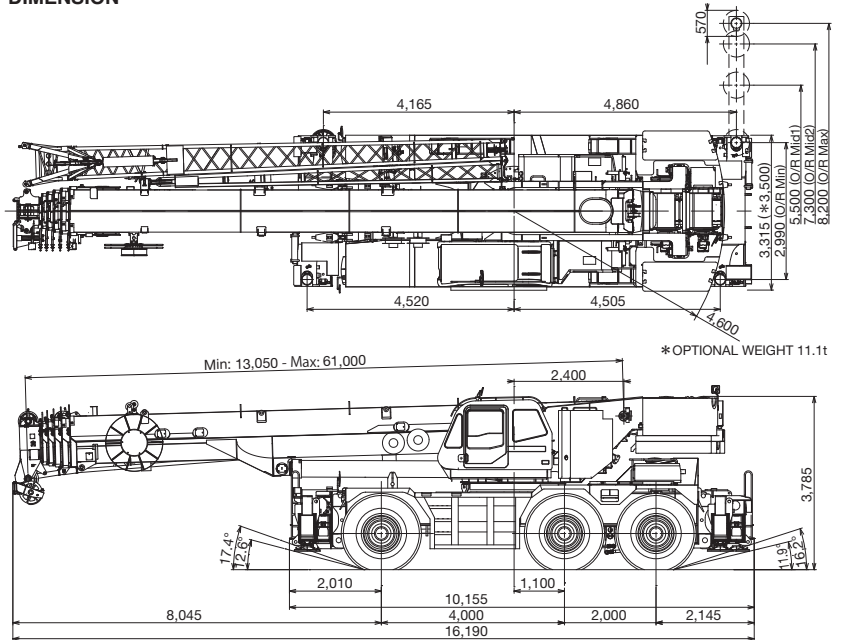

There are two specification sheets available, Hydraulic offset jib and Manual offset jib, so please see specification sheet to clarify all your technical concerns.  
Working range and dimension chart show Hydraulic offset jib.

\*Some specifications are subject to change



TADANO LTD. (International Division)

4-12, Kamezawa 2-chome, Sumida-ku Tokyo 130-0014, Japan

Phone: 81-3-3621-7750 Fax: 81-3-3621-7785

http://www.tadano-global.com E-mail: tdnihq@tadano.co.jp

2013-11

Printed in Japan

**TADANO****ROUGH TERRAIN CRANE**

SPEC. SHEET NO. GR-1450E-2-00102/EX-03

# GR-1450EX

Left - hand steering

## GENERAL DATA

<b>CRANE CAPACITY</b>		145,000 kg at 2.5 m
<b>BOOM DIMENSION</b>		6-section, 13.1 m - 61.0m
Overall length	approx.	16,190 mm
Overall width	approx.	3,315 mm
Overall height	approx.	3,785 mm
<b>MASS</b>		
Gross vehicle mass	approx.	91,154 kg
-1st axle	approx.	29,398 kg
-2nd axle	approx.	30,640 kg
-3rd axle	approx.	31,116 kg
<b>PERFORMANCE</b>		
Max. travelling speed (with counterweight)	computed	15 km/h
Gradeability(tan $\theta$ ) (with 18.2t counterweight)	computed	52 % (at stall) *30 %

\*Machine should be operated within the limit of engine crankcase design (17° : MITSUBISHI 6M60-TL).

## CRANE SPECIFICATIONS

### MODEL

GR-1450EX

### CAPACITY

145,000 kg at 2.5 m

### BOOM

Six sections extended by single telescoping cylinder, 13.1m~61.0m, of round box construction with 7 sheaves, 0.400m root diameter, at boom head.

Hydraulic cylinders fitted with holding valves.

Fully retracted length	13.1 m
Fully extended length	61.0 m
Extension speed	47.9 m in 450 s

### JIB

Two staged slewing around boom extension. Offset angle (5°-40°) by tilt cylinder. Stows alongside base boom section.

Assistant cylinders for mounting and stowing.

Single sheave at jib head.

Length	10.3 m and 18.0 m
--------	-------------------

### SINGLE TOP (AUXILIARY BOOM SHEAVE)

Single sheave, 0.440m root diameter. Mounted to main boom head for single line work.

### ELEVATION

By a double-acting hydraulic cylinder, fitted with holding valve.

Automatic speed reduction and slow stop function.

Boom angle ..... -1.5° to 81.5°

Boom raising speed ..... 20° to 60° in 28 s

### HOIST— Main winch

Variable speed type with grooved drum driven by hydraulic axial piston motor through winch speed reducer. Power load lowering and hoisting. Equipped with automatic brake (Neutral brake) and counterbalance valve. Controlled independently of auxiliary winch.

Single line pull	70.6 kN {7,200 kgf}
Single line speed(High)	136 m/min (at the 4th layer)
Single line speed(Low)	97 m/min (at the 4th layer)
Wire rope	No-spin type
Diameter x length	19 mm x 320 m

### HOOK BLOCK(Optional) - 100 t capacity

8 sheaves, swivel type hook with safety latch.

### HOOK BLOCK(Optional) -45 t capacity

3 sheaves, swivel type hook with safety latch.

**TADANO LTD.**

## HOIST— Auxiliary winch

Variable speed type with grooved drum driven by hydraulic axial piston motor through winch speed reducer. Power load lowering and hoisting.

Equipped with automatic brake (Neutral brake) and counterbalance valve. Controlled independently of main winch.

- Single line pull ..... 70.6 kN {7,200 kgf}
- Single line speed(High) ..... 136 m/min (at the 4th layer)
- Single line speed(Low) ..... 97 m/min (at the 4th layer)
- Wire rope ..... No-spin type
- Diameter x length ..... 19 mm x 225 m

## HOOK BLOCK - 7.2 t capacity

Swivel hook with safety latch for single line use.

## SLEWING

Hydraulic axial piston motor driven through planetary speed reducer. Continuous 360° full circle slewing on ball bearing slew ring. Equipped with manually locked/released slewing brake.

Front positive slewing lock manually engaged in cab. Twin slewing system: Free slewing or lock slewing controlled by selector switch on front console.

- Slewing speed ..... 1.3 min<sup>-1</sup> {rpm}

## HYDRAULIC SYSTEM

Pumps.....Two variable piston pumps for crane functions.

Tandem gear pump for steering, slewing and optional equipment.

Powered by carrier engine. Pump disconnect for crane is engaged/ disengaged by rotary switch from operator's cab.

Control valves.....Multiple valves actuated by pilot pressure with integral pressure relief valves.

Circuit.....Equipped with air cooled type oil cooler. Oil pressure appears on AML display for main circuit.

Hydraulic oil tank capacity.....  
approx. 763 liters

Filters.....Return line filter

## CRANE CONTROL

By 4 control levers for slewing, boom elevation, main winch, boom telescoping or auxiliary winch with 2 control pedals for boom elevation and boom telescoping based on ISO standard layout. Control lever stands can change neutral positions and tilt for easy access to cab.

## CAB

Both crane and drive operations can be performed from one cab mounted on rotating superstructure. 15° tilt, Left side, one-man type, steel construction with sliding door access and tinted safety glass windows opening at side. Door window is powered control. Operator's 3 way adjustable seat with headrest and armrest. Air conditioner (Hot water heater and cooler).

## TADANO Automatic Moment Limiter (Model: AML-C)

Main unit in crane cab gives audible and visual warning of approach to overload. Automatically cuts out crane motions before overload. With working range (load radius and/or boom angle and/or tip height and/or slewing range) limit function. Automatic speed reduction and slow stop function on boom elevation and slewing.

Following functions are displayed.

- Load as percentage
- Number of parts of line of rope
- Boom angle
- Boom length
- Load radius
- Outriggers position
- On-tire indicator
- Actual hook load
- Permissible load
- Boom position indicator
- Potential hook height
- Slewing angle
- Main hydraulic oil pressure
- Jib length and jib offset angle (only when jib operation)

## OUTRIGGERS

Hydraulically operated H-type outriggers. Each outrigger controlled simultaneously or independently from the cab. Equipped with sight level gauge. Floats can be stowed on vertical cylinders or removed to improve approach and departure angles. All cylinders fitted with pilot check valves. Crane operation with different extended length of each outrigger. Equipped with extension width detector for each outrigger. Outrigger unit is self-removable for ease of transportation.

Extended width

- Fully ..... 8,200 mm
- Middle ..... 7,300 mm
- Middle ..... 5,500 mm
- Minimum ..... 2,990 mm
- Float size (Diameter) ..... 570 mm

## COUNTERWEIGHT

STANDARD ... 18.2t. Hydraulically installed and removed.

OPTIONAL WEIGHT .... Additional 11.1t for total of 29.3t.

**NOTE :** Each crane motion speed is based on unladen conditions.

## TYPE

Rear engine, left hand steering, driving axle 2-way selected type by manual switch.

6x2 1st drive

6x4 1st and 3rd drive

## FRAME

High-tensile steel, all welded mono-box construction.

## ENGINE

Model ..... Mitsubishi 6M60-TL

Type ..... 4 cycle, turbo charged and after cooled, 6 cylinder in line, direct injection, water cooled diesel engine.

Piston displacement ..... 7,540 cm<sup>3</sup>

Bore x stroke ..... 118 mm x 115 mm

Max. output ..... 200 kW at 2,600 min<sup>-1</sup> {rpm}

Max. torque ..... 785 N-m at 1,400 min<sup>-1</sup> {rpm}

## TRANSMISSION

Electronically controlled full automatic transmission.

Torque converter driving full powershift with driving axle selector.

5 forward and 2 reverse speeds, constant mesh.

2 speeds - High range - 2 wheel drive ; 4 wheel drive

3 speeds - Low range - 4 wheel drive

## AXLES

1st ..... Full floating type, steering and driving axle with planetary reduction and open differential.

2nd ..... Steering and not driving axle.

3rd ..... Full floating type, steering and driving axle with planetary reduction and open differential.

## STEERING

Hydraulic power steering controlled by steering wheel.

Four steering modes available:

2-wheel front

4-wheel rear

6-wheel coordinated

6-wheel crab

## SUSPENSION

1st ..... Rigid mounted to frame.

2nd,3rd .... "Hydro-Pneumatic suspension cylinders" with leveling adjustment and oscillation.

## BRAKE SYSTEM

Service .... Air over hydraulic disc brakes on all 6 wheels.

Parking / Emergency ....

Spring applied-air released brake acting on input shaft of 1st and 3rd axle.

Auxiliary ..... Electro-pneumatic operated exhaust brake.

## ELECTRIC SYSTEM

24 V DC. 2 batteries of 12 V - 120 Ah capacity.

## FUEL TANK CAPACITY

300 liters

## TIRES

26.5R25☆☆, Air pressure:650kPa

## TURN RADIUS

Min. turning radius (at center of extreme outer tire)

2-wheel steering ..... 14.9 m

6-wheel steering ..... 9.9 m

## STANDARD EQUIPMENT

Automatic moment limiter (AML)  
External lamp (AML)  
Tare function  
Tadano twin slewing system and front positive slewing lock  
Winch automatic fail-safe brake  
Cable follower  
7.2 t capacity hook block (swivel hook)  
Anti-two-block device  
Hook safety latch  
Pilot check valves  
Holding valves  
Counterbalance valves  
Hydraulic pressure relief valves  
Slewing brake  
Boom angle indicator  
Boom elevation foot pedal  
Boom telescoping foot pedal  
Outrigger extension width detector  
Air conditioner (hot water heater and cooler)  
Sight level gauge  
Hydraulic oil cooler  
Electric windshield wiper and washer  
Roof window wiper and washer  
Power window (cab door)  
Tachometer/Speedometer  
15° tilt cab  
3 way adjustable cloth seat with seat belt, headrest and armrest  
Cab floor mat  
Sun visor (front and roof)  
Automatic drive system  
Transmission neutral position engine start

Overshift prevention  
Parking braked travel warning  
Tilt-telescope steering wheel  
Emergency steering  
Back-up alarm  
Air cleaner dust indicator  
Air dryer  
Water separator with filter  
Engine over-run alarm  
Towing eyes - front and rear  
Telematics (machine data logging and monitoring system) with - HELLO-NET via internet (availability depends on countries)  
Winch drum rotation indicator (visual type)  
Winch drum mirror  
2-speed hoist  
Self-removable counterweight  
Additional counterweight 11.1 t  
Self-removable outrigger unit  
Anemometer  
Boom and jib mounted aircraft warning lamp  
Removable boom system  
Fuel consumption monitor  
Positive control  
Eco mode system

## OPTIONAL EQUIPMENT

- 100 t capacity hook block (8 sheaves)
- Additional 100 t capacity hook block (8 sheaves) and additional sheaves < Used at lifting more than 100 t >
- 45 t capacity hook block (3 sheaves)
- Over-unwinding prevention
- Tire inflation kit

# WORKING RANGE

SPEC. SHEET NO. GR-1450E-2-00102/EX-03

Hydraulic offset jib  
Counterweight 29.3t

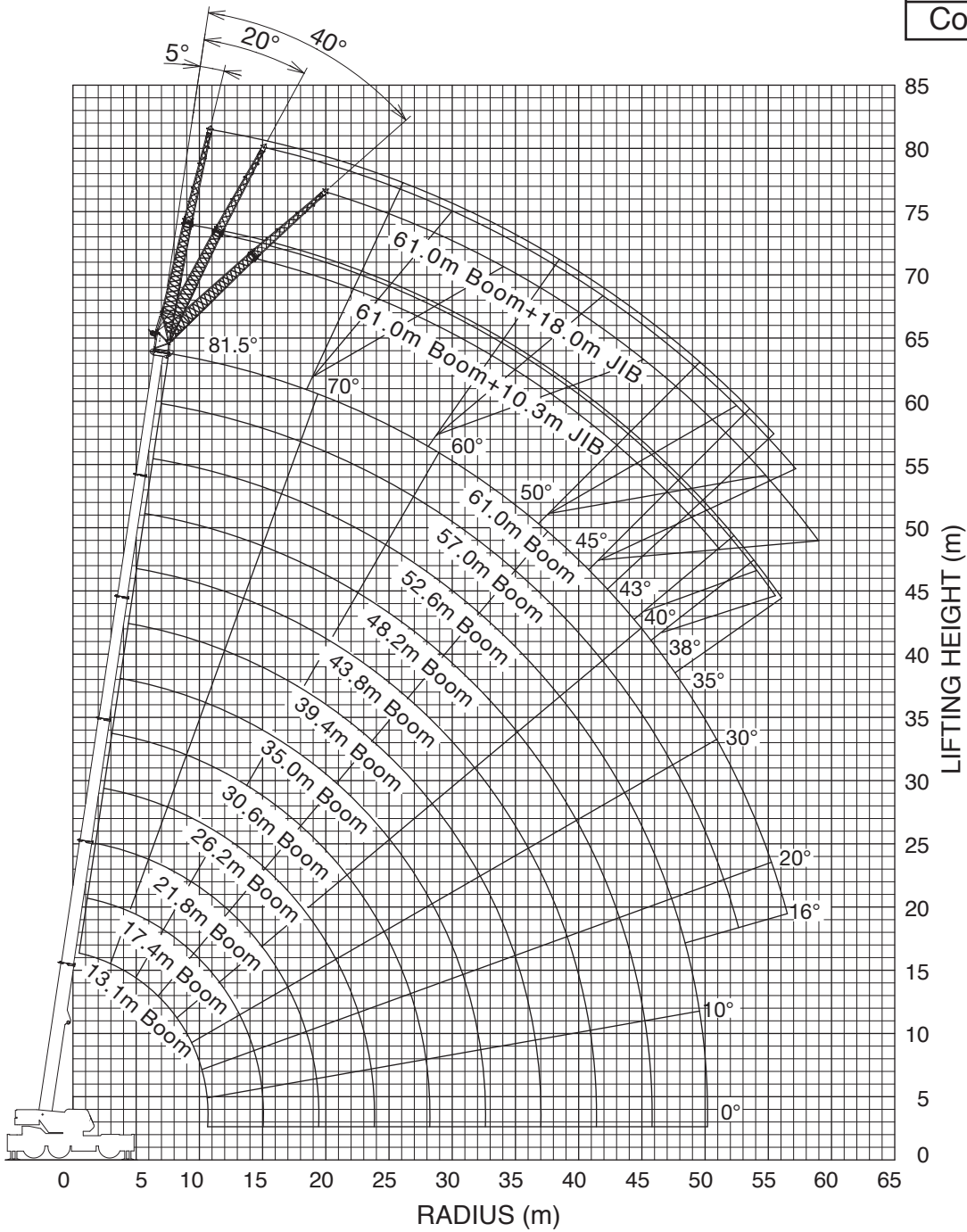

## BOOM

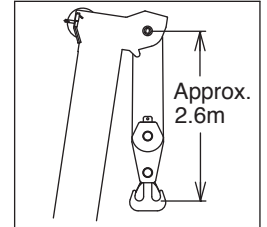

## JIB

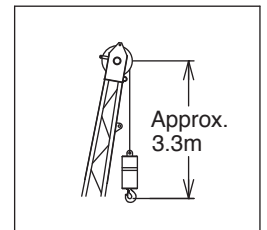

## SINGLE TOP

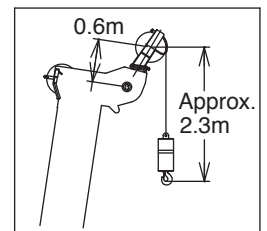

**NOTE:** 1. Boom and jib geometry shown are for unloaded condition and machine standing level on firm supporting surface.  
Boom deflection and subsequent radius and boom angle change must be accounted for when applying load to hook.

# WORKING RANGE

SPEC. SHEET NO. GR-1450E-2-00102/EX-03

Hydraulic offset jib
Counterweight 18.2t

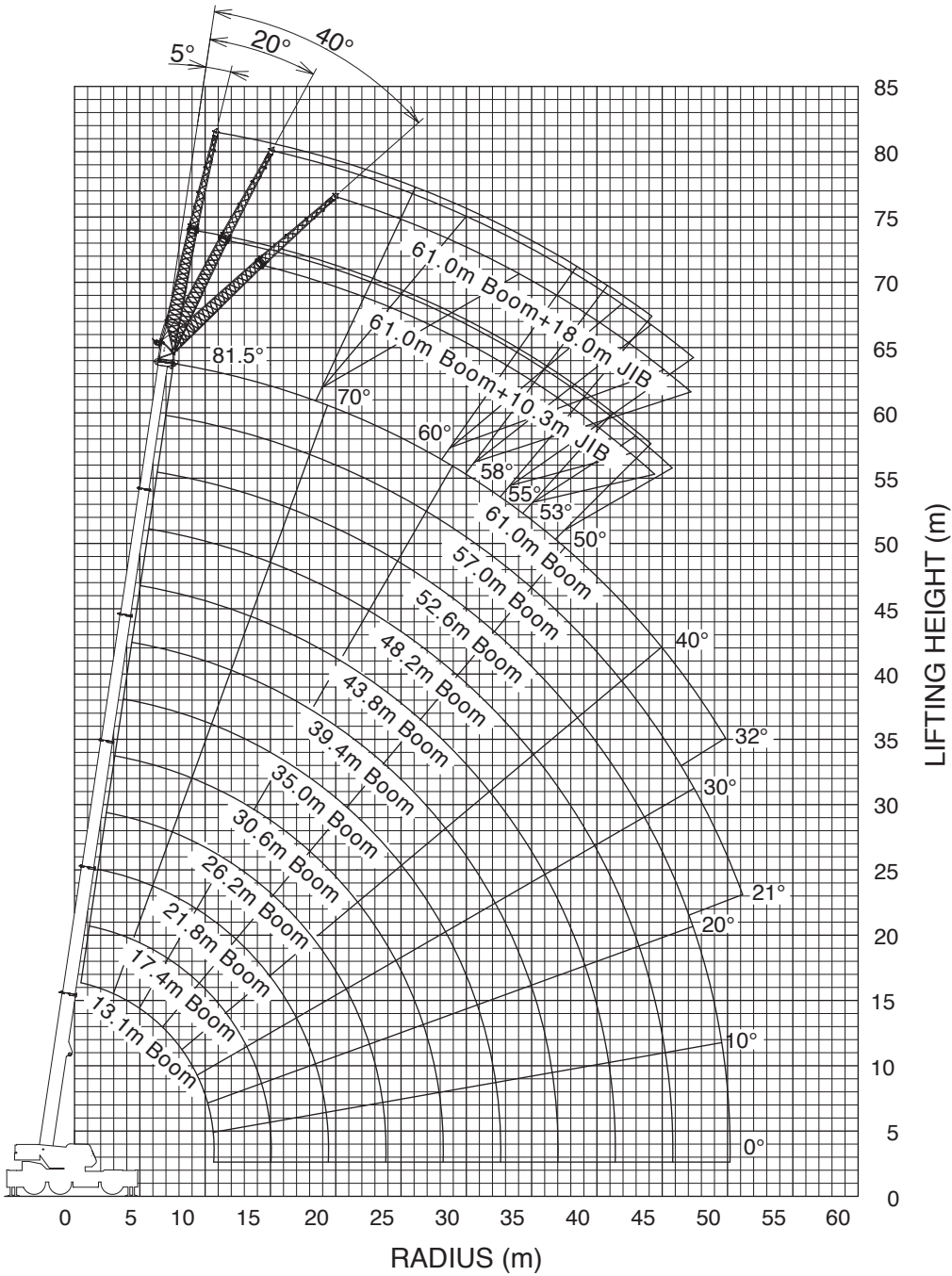

## BOOM

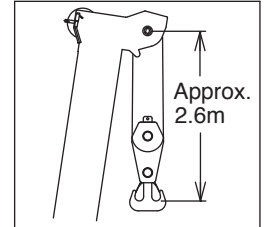

## JIB

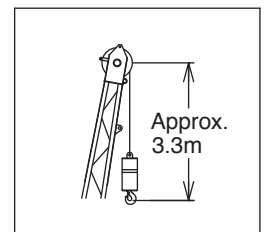

## SINGLE TOP

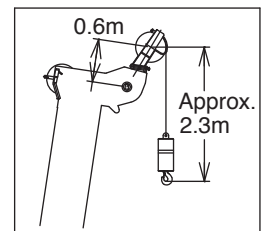

**NOTE:** 1. Boom and jib geometry shown are for unloaded condition and machine standing level on firm supporting surface.  
Boom deflection and subsequent radius and boom angle change must be accounted for when applying load to hook.



# RATED LIFTING CAPACITIES (IN METRIC TON) ISO4305

SPEC. SHEET NO. GR-1450E-2-00102/EX-03

## Boom

COUNTERWEIGHT 29.3t ON OUTRIGGERS FULLY EXTENDED 8.2m SPREAD 360° ROTATION (Unit:x1,000kg)												
A \ B	13.1m	17.4m	21.8m	26.2m	30.6m	35.0m	39.4m	43.8m	48.2m	52.6m	57.0m	61.0m
2.50	**145.0	90.7	79.0									
3.00	*110.6	90.7	79.0	37.0								
3.50	*101.5	90.7	79.0	66.0								
4.00	93.6	90.1	79.0	66.0	37.0							
4.50	85.9	83.7	79.0	66.0	48.2							
5.00	79.3	78.1	75.8	66.0	48.2	35.2						
5.50	73.5	73.2	71.0	66.0	48.2	35.2						
6.00	68.3	68.3	66.7	63.5	48.2	38.7						
6.50	63.7	64.1	63.6	60.5	48.2	37.5	30.1					
7.00	59.6	60.0	60.2	57.8	48.2	35.9	30.1					
7.50	56.0	56.4	56.5	55.3	48.2	35.2	30.1	22.1				
8.00	52.7	53.1	53.2	52.9	48.0	35.2	29.5	23.9				
9.00	46.8	47.3	47.5	47.2	44.8	35.2	27.9	23.9	17.2			
10.00	37.3	41.7	41.9	41.6	41.6	35.2	26.2	22.9	18.9	13.5		
11.00		37.1	37.3	37.5	37.7	33.2	24.4	22.0	18.9	15.0		
12.00		33.4	33.5	34.3	33.9	31.5	22.7	21.0	18.4	15.0	12.0	
14.00		27.8	27.6	28.4	28.0	28.4	20.9	19.2	16.9	15.0	12.0	10.4
16.00			23.3	24.0	24.3	24.3	19.3	17.1	15.5	14.1	12.0	10.4
18.00			21.2	20.2	21.3	20.7	17.8	15.4	14.3	13.1	12.0	10.4
20.00				18.1	17.8	17.3	16.5	14.0	12.9	12.1	11.2	10.2
22.00				15.4	15.2	14.6	15.2	12.7	11.8	11.2	10.4	9.6
24.00					13.0	13.6	13.1	11.7	10.8	10.4	9.8	9.0
26.00					11.3	11.9	11.4	10.8	10.1	9.6	9.1	8.4
28.00					8.2	10.5	9.9	9.6	9.4	8.8	8.5	7.8
30.00						9.3	8.7	9.1	8.6	8.2	8.0	7.3
32.00						8.3	7.7	8.0	7.5	7.7	7.4	6.7
34.00							6.8	7.1	6.9	7.0	6.6	6.2
36.00							6.1	6.3	6.5	6.2	5.8	5.8
38.00								5.9	5.8	5.5	5.1	5.1
40.00								5.5	5.2	4.9	4.5	4.5
42.00									4.6	4.4	3.9	3.9
44.00									4.2	3.9	3.4	3.4
46.00										3.4	3.0	3.0
48.00										3.1	2.6	2.6
50.00										2.7	2.2	2.2
52.00											1.9	1.9
54.00											1.7	1.6
56.00												1.3

\*\*Over front with special equipment

\*With special equipment

A :Boom length (m)

B :Load radius (m)

In this table, the thick line which divides strength area and stability area is not shown because the figure of this table is indicated the best performance at the same boom length among the plural telescopic boom patterns.

# RATED LIFTING CAPACITIES ISO4305

SPEC. SHEET NO. GR-1450E-2-00102/EX-03

**Jib**

COUNTERWEIGHT 29.3t ON OUTRIGGERS FULLY EXTENDED 8.2m SPREAD 360° ROTATION													
61.0m Boom + 10.3m Hydraulic offset jib							57.0m Boom + 10.3m Hydraulic offset jib						
C	5° Tilt		20° Tilt		40° Tilt		C	5° Tilt		20° Tilt		40° Tilt	
	R	W	R	W	R	W		R	W	R	W	R	W
81.5	14.7	5.5	17.4	5.5	20.4	5.1	81.5	12.9	6.2	15.7	6.2	18.7	5.8
81	15.6	5.5	18.6	5.5	21.1	5.0	81	13.7	6.2	16.5	6.2	19.3	5.7
80	17.2	5.5	19.9	5.4	22.6	4.9	80	15.2	6.2	17.9	6.1	20.6	5.5
79	18.8	5.5	21.2	5.2	24.0	4.7	79	16.7	6.2	19.3	5.9	21.9	5.4
78	20.5	5.5	22.6	5.0	25.2	4.6	78	18.2	6.2	20.6	5.7	23.0	5.2
77	21.9	5.4	24.4	4.9	26.5	4.5	77	19.6	6.2	21.9	5.6	24.3	5.1
76	23.3	5.2	25.3	4.7	27.8	4.4	76	20.8	6.0	23.2	5.4	25.4	4.9
75	27.3	5.0	26.7	4.6	28.9	4.2	75	22.1	5.8	24.3	5.2	26.6	4.8
73	31.0	4.8	29.3	4.4	31.3	4.0	73	24.6	5.4	26.8	4.9	28.9	4.6
70	33.5	4.3	33.0	4.0	34.8	3.8	70	28.2	5.0	30.3	4.6	32.1	4.3
68	37.2	4.1	35.4	3.8	37.0	3.6	68	30.6	4.7	32.4	4.3	34.2	4.1
65	37.0	3.8	38.8	3.6	40.1	3.4	65	33.8	4.3	35.6	4.0	37.1	3.8
63	39.2	3.6	40.9	3.4	42.2	3.3	63	36.1	4.2	37.7	3.9	39.0	3.7
60	42.5	3.3	43.8	3.1	45.1	3.0	60	39.1	3.9	40.6	3.7	41.9	3.5
58	44.5	3.1	46.0	3.0	47.0	2.9	58	41.2	3.7	42.5	3.5	43.7	3.4
55	47.2	2.8	48.6	2.7	49.6	2.7	55	43.9	3.5	45.2	3.3	46.1	3.2
53	49.2	2.7	50.4	2.6	51.1	2.5	53	45.6	3.3	46.9	3.2	47.7	3.1
50	51.3	2.3	52.7	2.2	53.1	2.1	50	47.9	3.0	49.2	2.9	49.6	2.8
48	52.8	2.0	54.1	1.9	54.5	1.9	48	49.3	2.7	50.6	2.6	50.8	2.5
45	55.0	1.7	56.1	1.6	56.3	1.5	45	51.4	2.3	52.5	2.2	52.6	2.1
43	56.3	1.4	57.4	1.4			43	52.6	2.0	53.6	1.9		
40	58.3	1.2	59.2	1.1			40	54.5	1.7	55.4	1.6		
38	59.5	1.0	60.3	0.9			38	55.7	1.5	56.5	1.5		
35	61.3	0.8					35	57.5	1.3	58.0	1.2		
33							33	58.5	1.1	59.0	1.1		
30							30	60.0	1.0	60.2	0.9		
28							28	60.8	0.8	61.1	0.8		
E				1			E				1		

COUNTERWEIGHT 29.3t ON OUTRIGGERS FULLY EXTENDED 8.2m SPREAD 360° ROTATION													
52.6m Boom + 10.3m Hydraulic offset jib							35.0m Boom + 10.3m Hydraulic offset jib						
C	5° Tilt		20° Tilt		40° Tilt		C	5° Tilt		20° Tilt		40° Tilt	
	R	W	R	W	R	W		R	W	R	W	R	W
81.5	11.3	7.2	14.3	7.2	17.4	6.8	81.5			8.9	10.6	11.3	7.3
81	12.0	7.2	15.0	7.2	18.0	6.7	81			9.3	10.5	11.7	7.2
80	13.4	7.2	16.3	7.2	19.2	6.5	80			10.1	10.2	12.5	7.1
79	14.8	7.2	17.6	7.0	20.3	6.3	79			10.9	10.0	13.2	7.0
78	16.1	7.2	18.8	6.8	21.4	6.1	78			11.9	9.7	14.0	6.9
77	17.5	7.2	19.9	6.6	22.5	5.9	77			12.6	9.5	14.8	6.9
76	18.8	7.2	21.1	6.4	23.6	5.8	76			13.3	9.3	15.5	6.8
75	19.6	6.9	22.3	6.2	24.6	5.6	75	11.8	12.8	14.1	9.1	16.2	6.7
73	22.0	6.5	24.4	5.8	26.7	5.4	73	13.4	12.2	15.6	8.7	17.6	6.5
70	25.7	5.9	27.6	5.4	29.6	5.0	70	15.6	11.3	17.9	8.2	19.7	6.3
68	27.9	5.6	29.8	5.2	31.6	4.8	68	17.2	10.8	19.3	7.9	21.0	6.2
65	31.0	5.2	32.7	4.8	34.3	4.5	65	19.3	10.1	21.4	7.6	22.9	6.1
63	33.2	5.0	34.6	4.6	36.1	4.4	63	20.7	9.6	22.8	7.4	24.2	6.0
60	36.0	4.6	37.5	4.4	38.8	4.2	60	22.8	9.0	24.8	7.1	26.0	5.9
58	37.8	4.4	39.2	4.2	40.4	4.0	58	24.1	8.7	26.0	6.9	27.2	5.8
55	40.4	4.1	41.7	3.9	42.7	3.8	55	26.0	8.2	27.9	6.7	28.9	5.7
53	42.0	3.9	43.3	3.8	44.1	3.6	53	27.2	7.9	29.0	6.5	29.9	5.7
50	44.4	3.6	45.5	3.4	46.1	3.3	50	29.0	7.6	30.7	6.4	31.4	5.7
48	45.8	3.3	46.8	3.1	47.4	3.0	48	30.1	7.4	31.7	6.3	32.4	5.6
45	47.7	2.8	48.6	2.7	49.1	2.6	45	31.7	7.1	33.2	6.1	33.8	5.6
43	49.0	2.5	49.8	2.4			43	32.7	7.0	34.2	6.1		
40	50.8	2.2	51.5	2.1			40	34.1	6.8	35.4	6.0		
38	51.8	1.9	52.6	1.9			38	35.1	6.6	36.3	5.9		
35	53.5	1.7	54.0	1.6			35	36.4	6.2	37.5	5.9		
33	54.4	1.5	54.9	1.4			33	37.2	5.9	38.2	5.7		
30	55.7	1.3	56.1	1.2			30	38.3	5.5	39.2	5.4		
28	56.6	1.2	56.8	1.1			28	39.0	5.3	39.7	5.2		
25	57.7	1.0	57.8	1.0			25	39.9	5.0	40.4	4.9		
23	58.3	0.9					23	40.4	4.9				
20	59.1	0.8					20	41.1	4.7				
E				1			E				2		

C :Loaded boom angle (°)  
R :Load radius (m)  
W:Rated lifting capacity (Unit:×1,000kg)  
E :Number of parts of line

# RATED LIFTING CAPACITIES ISO4305

SPEC. SHEET NO. GR-1450E-2-00102/EX-03

**Jib**

COUNTERWEIGHT 29.3t ON OUTRIGGERS FULLY EXTENDED 8.2m SPREAD 360° ROTATION													
C	61.0m Boom + 18.0m Hydraulic offset jib						C	57.0m Boom + 18.0m Hydraulic offset jib					
	5° Tilt		20° Tilt		40° Tilt			5° Tilt		20° Tilt		40° Tilt	
	R	W	R	W	R	W		R	W	R	W	R	W
81.5	17.1	3.7	22.0	3.7	27.1	3.2	81.5	14.6	4.0	20.0	4.0	24.7	3.3
81	18.0	3.7	22.7	3.7	28.0	3.2	81	15.0	4.0	20.8	4.0	25.5	3.3
80	19.9	3.7	24.7	3.7	29.6	3.1	80	17.2	4.0	22.5	4.0	27.0	3.2
79	21.6	3.7	26.3	3.7	31.1	3.1	79	18.8	4.0	23.8	3.9	28.3	3.2
78	23.4	3.7	27.9	3.6	32.5	3.0	78	20.3	4.0	25.4	3.8	29.7	3.2
77	25.0	3.7	29.3	3.5	34.0	3.0	77	21.9	4.0	26.7	3.7	31.0	3.1
76	26.8	3.7	30.9	3.4	35.3	3.0	76	23.5	4.0	28.2	3.6	32.3	3.1
75	28.5	3.7	32.3	3.3	36.4	2.9	75	25.0	4.0	29.6	3.6	33.4	3.0
73	31.4	3.5	35.0	3.1	39.2	2.8	73	28.1	4.0	32.3	3.5	35.9	3.0
70	35.6	3.2	39.0	2.9	42.6	2.6	70	32.2	3.7	36.2	3.3	39.4	2.9
68	38.4	3.1	41.3	2.7	44.9	2.5	68	34.8	3.5	38.6	3.2	41.8	2.8
65	42.1	2.8	45.3	2.6	48.1	2.4	65	38.5	3.3	42.1	3.0	44.7	2.8
63	44.7	2.7	47.5	2.5	50.3	2.3	63	41.0	3.2	44.4	2.9	46.8	2.7
60	48.4	2.5	50.8	2.3	53.3	2.2	60	44.5	3.0	47.5	2.7	49.7	2.6
58	50.5	2.3	52.9	2.2	55.1	2.1	58	46.6	2.9	49.6	2.6	51.5	2.5
55	53.7	2.1	55.8	2.0	57.6	1.9	55	49.7	2.7	52.5	2.5	54.1	2.4
53	55.6	1.9	57.5	1.8	58.9	1.6	53	51.5	2.5	54.1	2.3	55.4	2.2
50	58.2	1.6	59.7	1.4	60.9	1.3	50	54.1	2.2	56.3	1.9	57.4	1.8
48	59.7	1.3	61.3	1.2	62.2	1.1	48	55.6	1.9	57.8	1.7	58.6	1.6
45	62.0	1.0	63.3	0.9	64.0	0.8	45	57.8	1.5	59.8	1.4	60.4	1.3
43	63.4	0.8					43	59.2	1.3	61.1	1.2		
40							40	61.4	1.1	62.9	1.0		
38							38	62.6	0.9	64.0	0.8		
E			1				E			1			

COUNTERWEIGHT 29.3t ON OUTRIGGERS FULLY EXTENDED 8.2m SPREAD 360° ROTATION													
C	52.6m Boom + 18.0m Hydraulic offset jib						C	35.0m Boom + 18.0m Hydraulic offset jib					
	5° Tilt		20° Tilt		40° Tilt			5° Tilt		20° Tilt		40° Tilt	
	R	W	R	W	R	W		R	W	R	W	R	W
81.5	13.7	4.7	18.8	4.4	23.2	3.4	81.5	9.2	6.4	13.6	5.4	17.9	3.7
81	14.5	4.7	19.6	4.4	23.9	3.4	81	9.6	6.4	14.0	5.3	18.4	3.7
80	16.1	4.7	21.1	4.3	25.2	3.4	80	10.7	6.4	15.0	5.2	19.3	3.6
79	17.6	4.7	22.4	4.2	26.4	3.3	79	11.7	6.4	16.0	5.1	20.1	3.6
78	19.2	4.7	23.8	4.1	27.7	3.3	78	12.7	6.4	16.9	5.0	20.9	3.6
77	20.5	4.7	25.0	4.0	28.9	3.3	77	13.6	6.4	17.8	4.8	21.7	3.5
76	22.0	4.7	26.3	3.9	29.9	3.2	76	14.6	6.4	18.6	4.7	22.5	3.5
75	23.4	4.7	27.7	3.9	31.2	3.2	75	15.6	6.4	19.5	4.6	23.3	3.5
73	26.4	4.6	30.1	3.7	33.4	3.1	73	17.4	6.0	21.4	4.5	24.9	3.4
70	30.0	4.3	33.7	3.5	36.6	3.0	70	20.1	5.6	23.8	4.2	27.1	3.3
68	34.6	4.2	36.0	3.4	38.7	3.0	68	21.8	5.3	25.5	4.1	28.5	3.2
65	36.2	4.0	39.4	3.3	41.5	2.9	65	24.4	5.0	27.9	3.9	30.6	3.2
63	38.4	3.8	41.3	3.2	43.5	2.9	63	26.0	4.8	29.4	3.8	32.0	3.2
60	41.6	3.6	44.5	3.1	46.2	2.8	60	28.4	4.6	31.6	3.6	34.0	3.1
58	43.7	3.4	46.5	3.1	48.0	2.8	58	29.9	4.4	33.1	3.6	35.3	3.1
55	46.5	3.2	49.5	3.0	50.3	2.8	55	32.1	4.2	35.1	3.4	37.1	3.1
53	48.4	3.0	50.8	2.8	51.5	2.6	53	33.6	4.1	36.5	3.4	38.1	3.0
50	50.9	2.6	53.0	2.4	53.4	2.2	50	35.6	3.9	38.3	3.3	39.7	3.0
48	52.4	2.3	54.4	2.1	54.6	2.0	48	37.0	3.8	39.6	3.3	40.7	3.0
45	54.7	2.0	56.3	1.8	56.4	1.6	45	38.8	3.7	41.2	3.2	42.0	3.0
43	56.0	1.7	57.6	1.6			43	40.0	3.6	42.2	3.2		
40	58.0	1.4	59.4	1.3			40	41.6	3.5	43.6	3.1		
38	59.4	1.3	60.5	1.1			38	43.7	3.4	44.5	3.1		
35	61.3	1.0	62.0	0.9			35	44.2	3.3	45.8	3.1		
33	62.4	0.9	62.9	0.8			33	45.1	3.3	46.5	3.1		
30							30	46.4	3.2	47.5	3.1		
28							28	47.2	3.2	48.1	3.1		
25							25	48.2	3.1	48.8	3.1		
23							23	48.8	3.1				
20							20	49.6	3.1				
E			1				E			1			

C :Loaded boom angle (°)  
R :Load radius (m)  
W:Rated lifting capacity (Unit:×1,000kg)  
E :Number of parts of line

# RATED LIFTING CAPACITIES ISO4305

SPEC. SHEET NO. GR-1450E-2-00102/EX-03

## Jib

COUNTERWEIGHT 18.2t ON OUTRIGGERS FULLY EXTENDED 8.2m SPREAD 360° ROTATION													
C	61.0m Boom + 10.3m Hydraulic offset jib						C	57.0m Boom + 10.3m Hydraulic offset jib					
	5° Tilt		20° Tilt		40° Tilt			5° Tilt		20° Tilt		40° Tilt	
	R	W	R	W	R	W		R	W	R	W	R	W
81.5	14.7	5.5	17.4	5.5	20.4	5.1	81.5	12.9	6.2	15.7	6.2	18.7	5.8
81	15.6	5.5	18.6	5.5	21.1	5.0	81	13.7	6.2	16.5	6.2	19.3	5.7
80	17.2	5.5	19.9	5.4	22.6	4.9	80	15.2	6.2	17.9	6.1	20.6	5.5
79	18.8	5.5	21.2	5.2	24.0	4.7	79	16.7	6.2	19.3	5.9	21.9	5.4
78	20.5	5.5	22.6	5.0	25.2	4.6	78	18.2	6.2	20.6	5.7	23.0	5.2
77	21.9	5.4	24.4	4.9	26.5	4.5	77	19.6	6.2	21.9	5.6	24.3	5.1
76	23.3	5.2	25.3	4.7	27.8	4.4	76	20.8	6.0	23.2	5.4	25.4	4.9
75	27.3	5.0	26.7	4.6	28.9	4.2	75	22.1	5.8	24.3	5.2	26.6	4.8
73	31.0	4.8	29.3	4.4	31.3	4.0	73	24.6	5.4	26.8	4.9	28.9	4.6
70	33.5	4.3	33.0	4.0	34.8	3.8	70	28.2	5.0	30.3	4.6	32.1	4.3
68	37.2	4.1	35.4	3.8	37.0	3.6	68	30.6	4.7	32.4	4.3	34.2	4.1
65	37.0	3.8	38.8	3.6	40.1	3.4	65	33.8	4.3	35.6	4.0	37.1	3.8
63	39.2	3.4	40.9	3.1	42.2	2.9	63	36.1	4.2	37.7	3.9	38.9	3.6
60	41.5	2.6	43.2	2.4	44.2	2.2	60	38.7	3.4	40.2	3.1	41.3	2.9
58	43.1	2.1	44.8	2.0	45.9	1.9	58	40.3	2.9	41.9	2.7	42.8	2.5
55	45.8	1.6	47.3	1.5	48.3	1.4	55	42.8	2.2	44.2	2.1	45.1	2.0
53	47.4	1.3	48.9	1.2	49.8	1.1	53	44.4	1.9	45.8	1.8	46.6	1.7
50	49.9	0.9	51.2	0.8			50	46.6	1.4	48.0	1.3	48.6	1.3
48							48	48.2	1.2	49.4	1.1	49.9	1.0
45							45	50.3	0.8	51.5	0.8		
E			1				E			1			

COUNTERWEIGHT 18.2t ON OUTRIGGERS FULLY EXTENDED 8.2m SPREAD 360° ROTATION													
C	52.6m Boom + 10.3m Hydraulic offset jib						C	35.0m Boom + 10.3m Hydraulic offset jib					
	5° Tilt		20° Tilt		40° Tilt			5° Tilt		20° Tilt		40° Tilt	
	R	W	R	W	R	W		R	W	R	W	R	W
81.5	11.3	7.2	14.3	7.2	17.4	6.8	81.5			8.9	10.6	11.3	7.3
81	12.0	7.2	15.0	7.2	18.0	6.7	81			9.3	10.5	11.7	7.2
80	13.4	7.2	16.3	7.2	19.2	6.5	80			10.1	10.2	12.5	7.1
79	14.8	7.2	17.6	7.0	20.3	6.3	79			10.9	10.0	13.2	7.0
78	16.1	7.2	18.8	6.8	21.4	6.1	78			11.9	9.7	14.0	6.9
77	17.5	7.2	19.9	6.6	22.5	5.9	77			12.6	9.5	14.8	6.9
76	18.8	7.2	21.1	6.4	23.6	5.8	76			13.3	9.3	15.5	6.8
75	19.6	6.9	22.3	6.2	24.6	5.6	75	11.8	12.8	14.1	9.1	16.2	6.7
73	22.0	6.5	24.4	5.8	26.7	5.4	73	13.4	12.2	15.6	8.7	17.6	6.5
70	25.7	5.9	27.6	5.4	29.6	5.0	70	15.6	11.3	17.9	8.2	19.7	6.3
68	27.9	5.6	29.8	5.2	31.6	4.8	68	17.2	10.8	19.3	7.9	21.0	6.2
65	31.0	5.2	32.7	4.8	34.3	4.5	65	19.3	10.1	21.4	7.6	22.9	6.1
63	33.2	5.0	34.6	4.6	36.1	4.3	63	20.7	9.6	22.8	7.4	24.2	6.0
60	35.6	4.1	37.1	3.7	38.4	3.5	60	22.8	9.0	24.8	7.1	26.0	5.9
58	37.1	3.5	38.6	3.2	39.8	3.0	58	24.1	8.7	26.0	6.9	27.2	5.8
55	39.5	2.8	40.9	2.6	42.0	2.5	55	26.0	8.2	27.9	6.7	28.9	5.7
53	41.0	2.4	42.4	2.2	43.3	2.1	53	27.2	7.9	29.0	6.5	29.9	5.7
50	43.2	1.9	44.6	1.8	45.3	1.7	50	28.9	7.0	30.7	6.4	31.4	5.7
48	44.6	1.6	45.9	1.5	46.6	1.4	48	30.0	6.4	31.7	6.0	32.4	5.6
45	46.7	1.2	47.8	1.1	48.4	1.0	45	31.6	5.7	33.2	5.4	33.7	5.2
43	48.0	1.0	49.1	0.9			43	32.6	5.3	34.1	5.0		
40							40	34.0	4.8	35.4	4.5		
38							38	34.9	4.4	36.2	4.3		
35							35	36.2	4.0	37.3	3.9		
33							33	37.0	3.8	38.0	3.7		
30							30	38.1	3.5	39.0	3.4		
28							28	38.8	3.3	39.5	3.2		
25							25	39.7	3.1	40.2	3.0		
23							23	40.3	3.0				
20							20	41.0	2.8				
E			1				E			2			

C : Loaded boom angle (°)  
R : Load radius (m)  
W : Rated lifting capacity (Unit:×1,000kg)  
E : Number of parts of line

# RATED LIFTING CAPACITIES ISO4305

SPEC. SHEET NO. GR-1450E-2-00102/EX-03

**Jib**

COUNTERWEIGHT 18.2t ON OUTRIGGERS FULLY EXTENDED 8.2m SPREAD 360° ROTATION						
C	61.0m Boom + 18.0m Hydraulic offset jib					
	5° Tilt		20° Tilt		40° Tilt	
	R	W	R	W	R	W
81.5	17.1	3.7	22.0	3.7	27.1	3.2
81	18.0	3.7	22.7	3.7	28.0	3.2
80	19.9	3.7	24.7	3.7	29.6	3.1
79	21.6	3.7	26.3	3.7	31.1	3.1
78	23.4	3.7	27.9	3.6	32.5	3.0
77	25.0	3.7	29.3	3.5	34.0	3.0
76	26.8	3.7	30.9	3.4	35.3	3.0
75	28.5	3.7	32.3	3.3	36.4	2.9
73	31.4	3.5	35.0	3.1	39.2	2.8
70	35.6	3.2	39.0	2.9	42.6	2.6
68	38.4	3.1	41.3	2.7	44.9	2.5
65	42.1	2.8	45.0	2.5	47.9	2.2
63	44.3	2.4	46.9	2.1	49.3	1.8
60	46.9	1.7	49.5	1.5	51.8	1.3
58	48.9	1.4	51.3	1.2	53.4	1.0
55	51.7	0.9	54.0	0.8		
53						
50						
E			1			

C	57.0m Boom + 18.0m Hydraulic offset jib					
	5° Tilt		20° Tilt		40° Tilt	
	R	W	R	W	R	W
81.5	14.6	4.0	20.0	4.0	24.7	3.3
81	15.0	4.0	20.8	4.0	25.5	3.3
80	17.2	4.0	22.5	4.0	27.0	3.2
79	18.8	4.0	23.8	3.9	28.3	3.2
78	20.3	4.0	25.4	3.8	29.7	3.2
77	21.9	4.0	26.7	3.7	31.0	3.1
76	23.5	4.0	28.2	3.6	32.3	3.1
75	25.0	4.0	29.6	3.6	33.4	3.0
73	28.1	4.0	32.3	3.5	35.9	3.0
70	32.2	3.7	36.2	3.3	39.4	2.9
68	34.8	3.5	38.6	3.2	41.8	2.8
65	38.5	3.3	42.1	3.0	41.8	2.8
63	41.0	3.1	44.0	2.7	46.3	2.3
60	43.7	2.4	46.7	2.1	48.8	1.8
58	45.5	2.0	48.4	1.7	50.4	1.5
55	48.0	1.4	50.9	1.3	52.7	1.1
53	49.9	1.2	52.6	1.0	54.1	0.9
50	52.3	0.8				
E			1			

COUNTERWEIGHT 18.2t ON OUTRIGGERS FULLY EXTENDED 8.2m SPREAD 360° ROTATION						
C	52.6m Boom + 18.0m Hydraulic offset jib					
	5° Tilt		20° Tilt		40° Tilt	
	R	W	R	W	R	W
81.5	13.7	4.7	18.8	4.4	23.2	3.4
81	14.5	4.7	19.6	4.4	23.9	3.4
80	16.1	4.7	21.1	4.3	25.2	3.4
79	17.6	4.7	22.4	4.2	26.4	3.3
78	19.2	4.7	23.8	4.1	27.7	3.3
77	20.5	4.7	25.0	4.0	28.9	3.3
76	22.0	4.7	26.3	3.9	29.9	3.2
75	23.4	4.7	27.7	3.9	31.2	3.2
73	26.4	4.6	30.1	3.7	33.4	3.1
70	30.0	4.3	33.7	3.5	36.6	3.0
68	34.6	4.2	36.0	3.4	38.7	3.0
65	36.2	4.0	39.4	3.3	41.5	2.9
63	38.3	3.7	41.3	3.2	43.4	2.8
60	40.8	2.9	43.9	2.5	45.7	2.2
58	42.8	2.5	45.6	2.2	47.2	1.9
55	45.3	1.9	48.1	1.7	49.4	1.5
53	47.1	1.6	49.6	1.4	50.8	1.2
50	49.6	1.1	52.0	1.0	52.7	0.8
48	51.4	0.9	53.4	0.8		
45						
43						
40						
38						
35						
33						
30						
28						
25						
23						
20						
E			1			

C	35.0m Boom + 18.0m Hydraulic offset jib					
	5° Tilt		20° Tilt		40° Tilt	
	R	W	R	W	R	W
81.5	9.2	6.4	13.6	5.4	17.9	3.7
81	9.6	6.4	14.0	5.3	18.4	3.7
80	10.7	6.4	15.0	5.2	19.3	3.6
79	11.7	6.4	16.0	5.1	20.1	3.6
78	12.7	6.4	16.9	5.0	20.9	3.6
77	13.6	6.4	17.8	4.8	21.7	3.5
76	14.6	6.4	18.6	4.7	22.5	3.5
75	15.6	6.4	19.5	4.6	23.3	3.5
73	17.4	6.0	21.4	4.5	24.9	3.4
70	20.1	5.6	23.8	4.2	27.1	3.3
68	21.8	5.3	25.5	4.1	28.5	3.2
65	24.4	5.0	27.9	3.9	30.6	3.2
63	26.0	4.8	29.4	3.8	32.0	3.2
60	28.4	4.6	31.6	3.6	34.0	3.1
58	29.9	4.4	33.1	3.6	35.3	3.1
55	32.1	4.2	35.1	3.4	37.1	3.1
53	33.6	4.1	36.5	3.4	38.1	3.0
50	35.6	3.9	38.3	3.3	39.7	3.0
48	37.0	3.8	39.6	3.3	40.7	3.0
45	38.8	3.7	41.2	3.2	42.0	3.0
43	40.0	3.6	42.2	3.2		
40	41.6	3.5	43.6	3.1		
38	42.3	3.3	44.5	3.1		
35	44.1	3.0	45.7	2.8		
33	45.0	2.8	46.4	2.6		
30	46.2	2.5	47.4	2.4		
28	47.0	2.4	47.9	2.3		
25	48.0	2.2	48.6	2.1		
23	48.6	2.1				
20	49.4	2.0				
E			1			

C :Loaded boom angle (°)  
R :Load radius (m)  
W:Rated lifting capacity (Unit:x1,000kg)  
E :Number of parts of line

# RATED LIFTING CAPACITIES

SPEC. SHEET NO. GR-1450E-2-00102/EX-03

## NOTES FOR "ON OUTRIGGERS" TABLE

- Rated lifting capacities shown in the table are based on condition that crane is set on firm level surface. Those above thick lines are based on crane strength and those below, on its stability. (Excluding the table shown in page 7)
- Rated lifting capacities based on crane stability are according to ISO4305.
- The mass of the hook (1,080 kg for 100t capacity, 610 kg for 45t capacity, 300 kg for 7.2 t capacity), slings and all similarly used load handling devices must be considered as part of the load and must be deducted from the lifting capacities.
- For rated lifting capacity of single top, reduce the rated lifting capacities of relevant boom according to a weight reduction for auxiliary load handling equipment. Capacities of single top shall not exceed 7,200 kg including main boom hook mass and the net capacity must be so reduced.
- Standard number of parts of line for each boom length is as shown below. Load per line should not surpass 70.6 kN {7,200 kgf} for main winch and auxiliary winch.

Boom length	13.1m	17.4m				21.8m				26.2m			
Telescoping conditions (%)													
Tele. 1	0	0	0	0	0	0	45	0	0	0	45	0	
Tele. 2	0	0	45	0	0	0	45	45	0	0	45	45	
Tele. 3	0	0	0	45	0	0	0	45	0	45	45	45	
Tele. 4	0	0	0	0	0	45	0	0	45	45	0	45	
Tele. 5	0	45	0	0	90	45	0	0	90	45	0	0	
Number of parts of line	22	6	14	14	6	6	12	12	6	6	10	9	

Boom length	30.6m				35.0m				39.4m			
Telescoping conditions (%)												
Tele. 1	0	0	90	45	0	45	90	0	0	90	45	
Tele. 2	0	45	45	45	0	45	45	45	0	45	45	
Tele. 3	0	45	45	45	45	45	45	45	90	45	45	
Tele. 4	90	45	0	45	90	45	45	45	90	45	45	
Tele. 5	90	45	0	0	90	45	0	90	90	45	90	
Number of parts of line	6	6	8	8	6	6	7	6	4	6	6	

Boom length	43.8m				48.2m			52.6m	57.0m	61.0m
Telescoping conditions (%)										
2nd boom	0	45	90	90	0	90	45	45	90	100
3rd boom	45	45	90	45	90	90	90	90	90	100
4th boom	90	45	45	45	90	90	90	90	90	100
5th boom	90	90	45	45	90	45	90	90	90	100
Top boom	90	90	45	90	90	45	45	90	45	100
Number of parts of line	4	4	4	4	4	4	4	4	4	4

The lifting capacity data stowed in the AUTOMATIC MOMENT LIMITER (AML) is based on the standard number of parts of line listed in the chart.

Maximum lifting capacity is restricted by the number of parts of line of AUTOMATIC MOMENT LIMITER (AML).

# RATED LIFTING CAPACITIES ISO4305

SPEC. SHEET NO. GR-1450E-2-00102/EX-03

WITHOUT COUNTERWEIGHT ON-RUBBER STATIONARY (Unit: x 1,000kg)												
B	A	Over front and rear						360° Rotation				
		13.1m		17.4m		21.8m		13.1m		17.4m		21.8m
		C		C		C		C		C		C
2.50	73	10.0	78	10.0	80	10.0	73	10.0	78	10.0	80	10.0
3.00	71	10.0	76	10.0	79	10.0	71	10.0	76	10.0	79	10.0
3.50	68	10.0	74	10.0	78	10.0	68	9.9	74	10.0	78	10.0
4.00	66	10.0	72	10.0	76	10.0	66	8.0	72	9.7	76	10.0
4.50	63	10.0	71	10.0	75	10.0	63	6.4	71	8.1	75	9.0
5.00	61	9.2	69	10.0	74	10.0	61	5.1	69	6.8	74	7.7
5.50	58	8.0	67	9.5	72	10.0	58	4.0	67	5.7	72	6.6
6.00	55	6.9	65	8.4	71	9.1	55	3.0	65	4.7	71	5.6
6.50	52	5.9	63	7.4	69	8.1	52	2.1	63	3.9	69	4.8
7.00	49	5.1	61	6.5	68	7.4			61	3.1	68	4.1
7.50	46	4.3	59	5.8	67	6.6			59	2.4	67	3.3
8.00	43	3.3	57	5.1	65	5.9			57	1.7	65	2.7
9.00	35	1.8	53	3.7	62	4.6					62	1.7
10.00			49	2.4	59	3.4						
11.00			44	1.5	56	2.4						
12.00					52	1.7						
D		0		40		50		47		56		59
Telescoping conditions(%)												
Tele.1		0		0		0		0		0		0
Tele.2		0		0		0		0		0		0
Tele.3		0		0		0		0		0		0
Tele.4		0		0		0		0		0		0
Tele.5		0		45		90		0		45		90
E								4				

NOTE: The lifting capacity data stored in the AUTOMATIC MOMENT LIMITER (AML) is based on the standard number of parts of line listed in the chart.  
Standard number of parts of line for on-rubber operation should be according to the chart.

- A :Boom length (m)
- B :Load radius (m)
- C :Loaded boom angle (°)
- D :Minimum boom angle (°) for indicated length (no load)
- E :Number of parts of line

## WORKING AREA

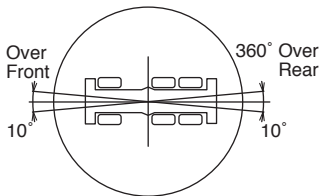

## NOTES FOR "ON RUBBER" TABLES

1. Rated lifting capacities shown in the table are based on condition that crane is set on firm level surface, with suspension lock applied. Those above thick lines are based on tire capacity and those below, on crane stability. They are based on actual load radius increased by tire deformation and boom deflection.
2. Rated lifting capacities based on crane stability are according to ISO4305.
3. The mass of the hook (1,080 kg for 100t capacity, 610 kg for 45t capacity, 300 kg for 7.2t capacity), slings and all similarly used load handling devices must be considered as part of the load and must be deducted from the lifting capacities.
4. For rated lifting capacity of single top, reduce the rated lifting capacities of relevant boom according to weight reductions for auxiliary load handling equipment. Capacities of single top shall not exceed 7,200 kg including main hook.
5. On-rubber lifting with "jib" is not permitted. Maximum permissible boom length is 21.8 m.
6. Tires should be inflated to their correct air pressure of 650kPa.
7. Standard number of parts of line for on-rubber operation should be according to the following table.  
Load per line should not surpass 70.6 kN {7,200 kgf} for main winch and auxiliary winch.

Boom length	13.1m	17.4m	21.8m
Telescoping conditions (%)			
Tele.1	0	0	0
Tele.2	0	0	0
Tele.3	0	0	0
Tele.4	0	0	0
Tele.5	0	45	90
Number of parts of line	4	4	4

The lifting capacity data stowed in the AUTOMATIC MOMENT LIMITER (AML) is based on the standard number of parts of line listed in the chart.

Maximum lifting capacity is restricted by the number of parts of line of AUTOMATIC MOMENT LIMITER (AML).

## WORKING AREA

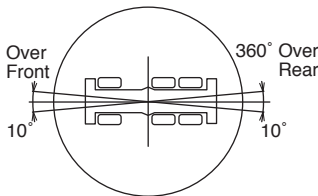

Over front and rear operation shall be performed within 10 degrees.



# DIMENSION

SPEC. SHEET NO. GR-1450E-2-00102/EX-03

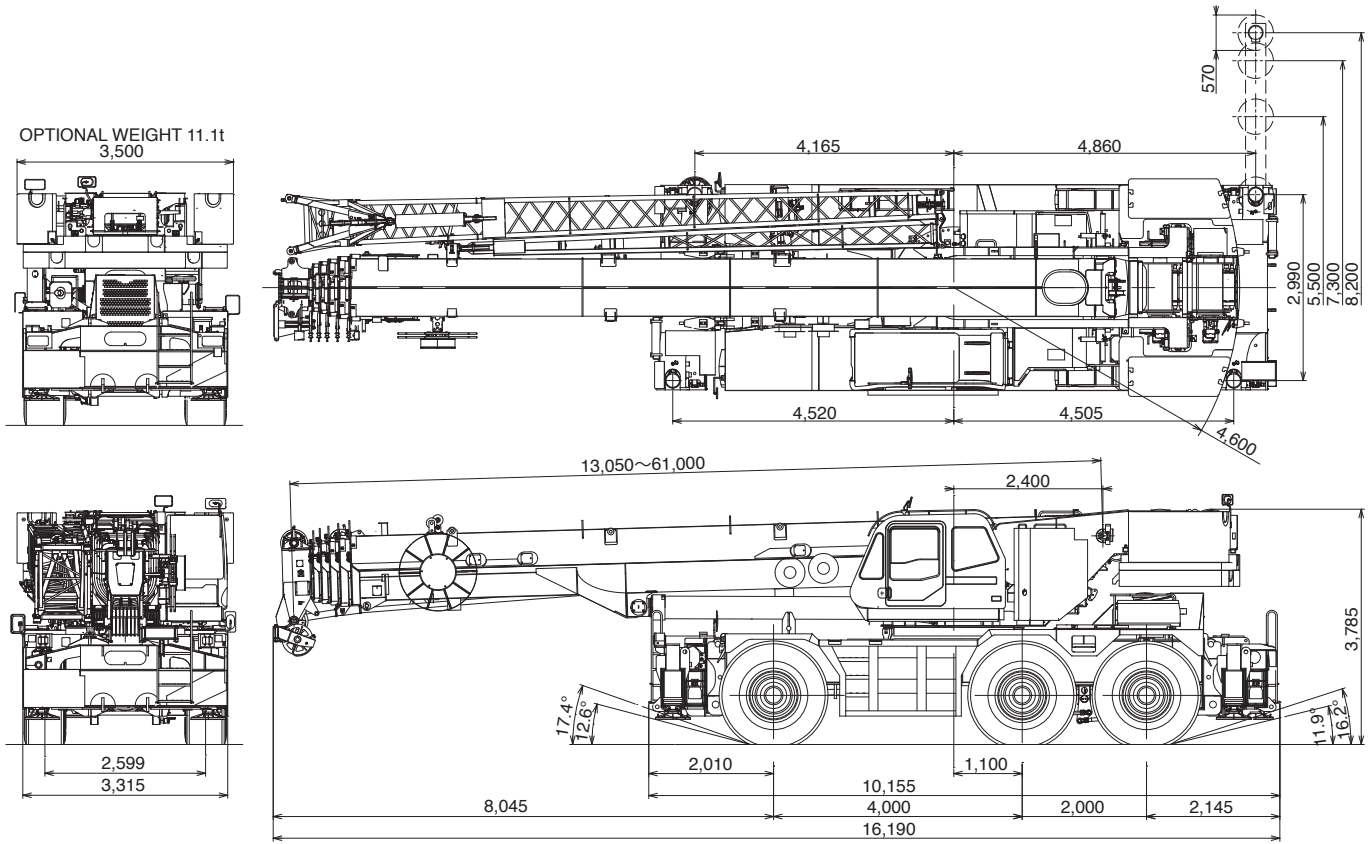

Note: Dimension is with boom angle at -1.5 degree.

## Axle Weight Distribution Chart

Unit : kg

	Kilograms			
	GVW	1st	2nd	3rd
Base machine	91,154	29,398	30,640	31,116
Remove:				
1.7.2 t hook block	-300	-421	61	61
2.100t hook block	-1,080	-1,771	346	346
3.Counterweight 11,100kg	-11,120	3,351	-7,236	-7,236
4.Counterweight 18,200kg	-18,160	5,473	-11,816	-11,816
5.Front outrigger unit	-4,481	-5,742	630	630
6.Rear outrigger unit	-4,481	2,279	-3,380	-3,380
7.Auxiliary Winch&wire rope	-1,202	490	-846	-846
8.Top jib	-387	-460	37	37
9.Base jib	-1,163	-2,042	439	439
10.Boom	-15,874	-20,041	2,083	2,083
Add:				
45t hook block	+610	+1,000	-195	-195

---

Specifications are subject to change without notice.



**TADANO**

**TADANO LTD.** (International Division)

4-12, Kamezawa 2-chome,  
Sumida-ku, Tokyo 130-0014, Japan

Tel : 81-(0)3-3621-7750

Fax : 81-(0)3-3621-7785

 <http://www.tadano-global.com>

 [tdnihq@tadano.co.jp](mailto:tdnihq@tadano.co.jp)

---

Printed in Japan

GR-1450EX-2013-11-1