



GR-550EX

Left hand steering

GENERAL DATA

CRANE CAPACITY	55,000 kg at 3.0 m	
BOOM	5-section, 11.1 m - 42.0 m	
DIMENSION		
Overall length	approx.	13,695 mm
Overall width	approx.	3,315 mm
Overall height	approx.	3,860 mm
MASS		
Gross vehicle mass	approx.	43,050 kg
-front axle	approx.	23,080 kg
-rear axle	approx.	19,970 kg
PERFORMANCE		
Max. travelling speed	computed	39 km/h
Gradeability(tan θ)	computed	153 % (at stall) * 30 %

*Machine should be operated within the limit of engine crankcase design (17°:MITSUBISHI 6M60-TLU3B).

CRANE SPECIFICATIONS

MODEL

GR-550EX

CAPACITY

55,000 kg at 3.0 m

BOOM

5-section full power partially synchronized telescoping boom of round hexagonal box construction with 5 sheaves at boom head. The synchronization system consists of 2 telescope cylinders, extension cables and retraction cables.

Hydraulic cylinders fitted with holding valves.

Fully retracted length.....11.1 m

Fully extended length42.0 m

Extension speed30.9 m in 128 s

JIB

2-staged swingaround boom extension. Triple offset (3.5°/25°/45°) type. Stores alongside base boom section.

Single sheave at jib head.

Assistant cylinders for mounting and stowing.

Length.....9.9 m and 17.7 m

SINGLE TOP (AUXILIARY BOOM SHEAVE)

Single sheave. Mounted to main boom head for single line work.

ELEVATION

By a double-acting hydraulic cylinder, fitted with holding valve.

Elevation speed..... -1.4° to 80.5° in 77 s

HOIST - Main winch

Variable speed type with grooved drum driven by hydraulic axial piston motor through winch speed reducer. Power load lowering and hoisting.

Equipped with automatic brake (Neutral brake) and counterbalance valve. Controlled independently of auxiliary winch.

Single line pull54.9 kN {5,600 kgf}

Single line speed147 m/min (at the 4th layer)

Wire rope.....Spin-resistant type

Diameter x length19 mm x 227 m

HOIST—Auxiliary winch

Variable speed type with grooved drum driven by hydraulic axial piston motor through winch speed reducer. Power load lowering and hoisting.

Equipped with automatic brake (Neutral brake) and counterbalance valve. Controlled independently of main winch.

- Single line pull54.9 kN {5,600 kgf}
- Single line speed126 m/min (at the 2nd layer)
- Wire ropeSpin-resistant type
- Diameter x length19 mm x 133 m

SWING

Hydraulic axial piston motor driven through planetary speed reducer. Continuous 360° full circle swing on ball bearing slew ring. Equipped with manually locked/released swing brake.

- Swing speed2.5 min⁻¹ {rpm}

HYDRAULIC SYSTEM

Pumps2 variable piston pumps for telescoping, elevating and winches.

Tandem gear pump for steering, swing and optional equipment.

Control valvesMultiple valves actuated by pilot pressure with integral pressure relief valves.

CircuitEquipped with air cooled type oil cooler. Oil pressure appears on AML display for main circuit.

Hydraulic oil tank capacity approx. 740 liters

FiltersReturn line filter

CRANE CONTROL

By 4 control levers for swing, boom hoist, main winch, boom telescoping or auxiliary winch with 2 control pedals for boom hoist and boom telescoping based on ISO standard layout.

Control lever stands can change neutral positions and tilt for easy access to cab.

CAB

Both crane and drive operations can be performed from one cab mounted on rotating superstructure. One sided one-man type, steel construction with sliding door access and tinted safety glass windows opening at side. Door window is powered control.

Operator's 3 way adjustable seat with headrest and armrest.

TADANO Automatic Moment Limiter (Model:AML-L)

Main unit in crane cab gives audible and visual warning of approach to overload. Automatically cuts out crane motions before overload.

With working range (load radius and/or boom angle and/or tip height and/or swing range) limit function.

Nine functions are displayed.

Digital liquid crystal display:

- Either boom angle or moment %
- Either boom length or potential hook height
- Either actual load radius or swing angle
- Actual hook load
- Permissible load
- Either jib offset angle or number of parts line of rope
- Boom position indicator
- Either outrigger position or on-tire indicator

Bar graphical display:

- Either moment as percentage or main hydraulic pressure (Display changes by alternation key on the AML front panel.)

OUTRIGGERS

4-Hydraulically operated H-type outriggers. Each outrigger controlled simultaneously or independently from the cab. Equipped with sight level gauge. Floats mounted integrally with the jacks retract to within vehicle width. All cylinders fitted with pilot check valves. Crane operation with different extended length of each outrigger. Equipped with extension width detector for each outrigger.

Extended width

- Fully7,200 mm
- Middle6,700 mm
- Middle5,500 mm
- Minimum2,800 mm
- Float size(Diameter)500 mm

COUNTERWEIGHT

Integral with swing frame

- Mass5,100 kg

NOTE :

Each crane motion speed is based on unladen conditions.

TYPE

Rear engine, left-hand steering, driving axle 2-way selected type (by manual switch).

- 4 x 2 front drive
- 4 x 4 front and rear drive

FRAME

High-tensile steel, all welded mono-box construction.

ENGINE

Model.....MITSUBISHI 6M60-TLU3B [EUROMOT Stage IIIA]
Type.....4 cycle, turbo charged and after cooled, 6 cylinder in line, direct injection, water cooled diesel engine.
Piston displacement7,545 cm³
Bore x stroke118 mm x 115 mm
Max. output.....200 kW {272 PS} at 2,600 min⁻¹ {rpm}
Max. torque785 N-m {80 kgf-m} at 1,400 min⁻¹ {rpm}

TRANSMISSION

Electronically controlled full automatic transmission.
Torque converter driving full powershift with driving axle selector. 6 forward and 2 reverse speeds.
3 speeds - High range - 2 wheel drive ; 4 wheel drive
3 speeds - Low range - 4 wheel drive

AXLES

Front.....Full floating type, steering and driving axle with planetary reduction.
Rear.....Full floating type, steering and driving axle with planetary reduction.
Non-spin differential.

STEERING

Hydraulic power steering controlled by steering wheel.
Four steering modes available:
2-wheel front
2-wheel rear
4-wheel coordinated
4-wheel crab

SUSPENSION

FrontRigid mounted to the frame.
Rear.....Pivot mounted with hydraulic lockout cylinders.

BRAKE SYSTEM

ServiceAir over hydraulic disc brakes on all 4 wheels.
Parking / Emergency.....
Spring applied-air released brake acting on input shaft of front axle.
Auxiliary....Electro-pneumatic operated exhaust brake.

ELECTRIC SYSTEM

24 V DC. 2 batteries of 12 V - 120 Ah capacity.

FUEL TANK CAPACITY

300 liters

TIRES

Front29.5 - 25 22PR(OR) or 29.5-25 28PR(OR),
Single x 2
Rear.....29.5 - 25 22PR(OR) or 29.5-25 28PR(OR),
Single x 2

TURN RADIUS

Min. turning radius (at center of extreme outer tire)
2-wheel steering 11.9 m
4-wheel steering 6.7 m

EQUIPMENT

STANDARD EQUIPMENT

Automatic moment limiter (AML-L)
External lamp (AML)
Pendant type over-winding cutout
Winch automatic fail-safe brake
Winch drum rotation indicator for main and auxiliary winch
Winch drum mirror
Cable follower
5.6 t capacity hook block (swivel hook)
Hook safety latch
Pilot check valves
Holding valves
Counterbalance valves
Hydraulic pressure relief valves
Swing brake
Swing lock (360° swing lock)
Boom angle indicator
Boom elevation foot pedal
Boom telescoping foot pedal
Outrigger extension width detector
Sight level gauge
Hydraulic oil cooler
Electric windshield wiper and washer
Roof window wiper and washer
Power window (Cab door)
Tachometer/Speedometer

3 way adjustable cloth seat with seat belt, headrest and armrest
Cab floor mat
Sun visor (Front and roof)
Automatic drive system
Transmission neutral position engine start
Overshift prevention
Parking braked travel warning
Tilt-telescope steering wheel
Back-up alarm
Air cleaner dust indicator
Air dryer
Water separator with filter
Engine over-run alarm
Hydraulic lockout suspension (Rear)
Non-spin differential (Rear)
Towing eyes - front and rear

OPTIONAL EQUIPMENT

- 55 t capacity hook block (6 sheaves)
- 40 t capacity hook block (4 sheaves)
- 20 t capacity hook block (2 sheaves)
- Over-unwinding prevention
- Air conditioner (hot water heater and cooler)
- Electric fan
- Tire inflation kit
- Emergency steering

Telescoping mode I

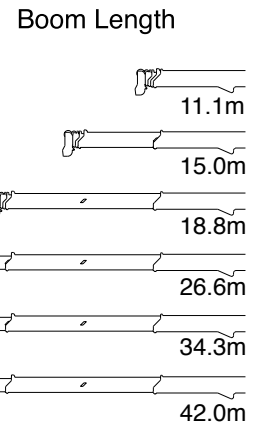
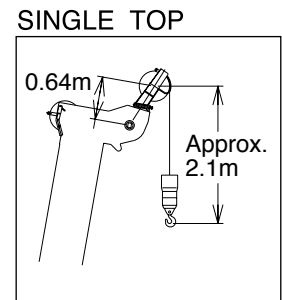
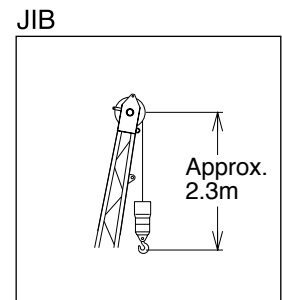
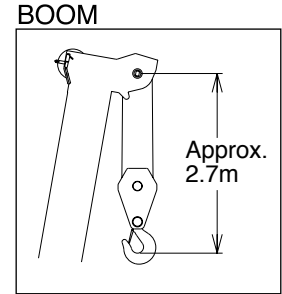
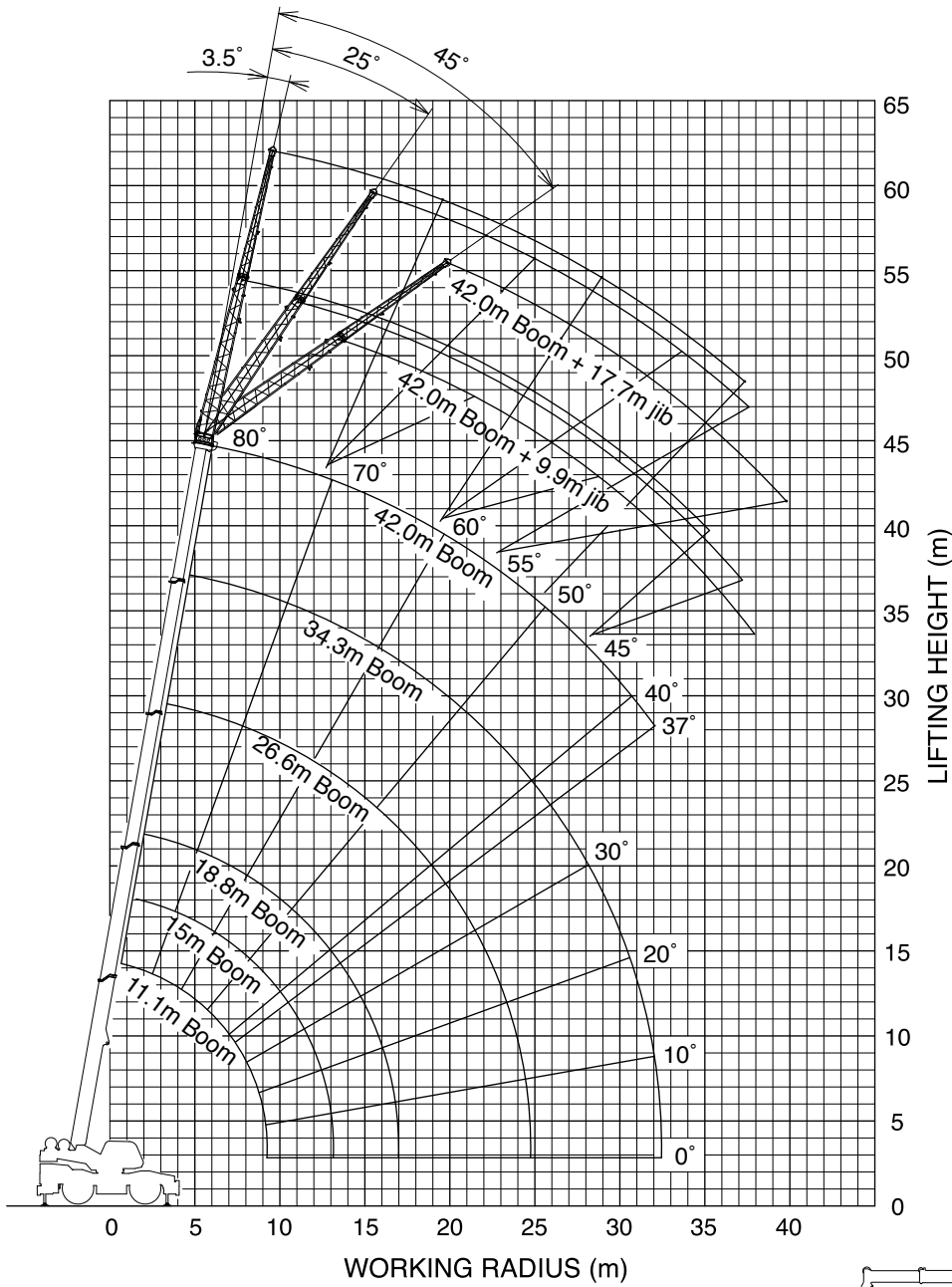

NOTE: The above lifting height and boom angle are based on a straight (unladen) boom, and allowance should be made for boom deflection obtained under laden conditions. The above working range is shown on condition with outriggers fully (7.2m) extended.

Telescoping mode II

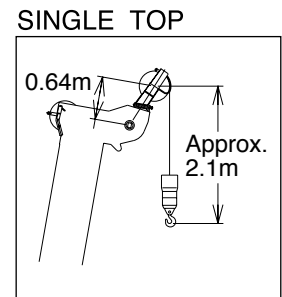
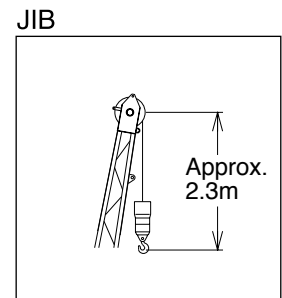
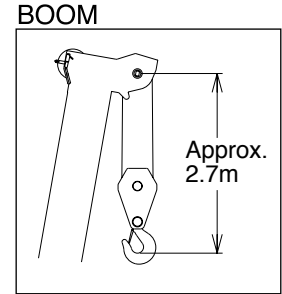
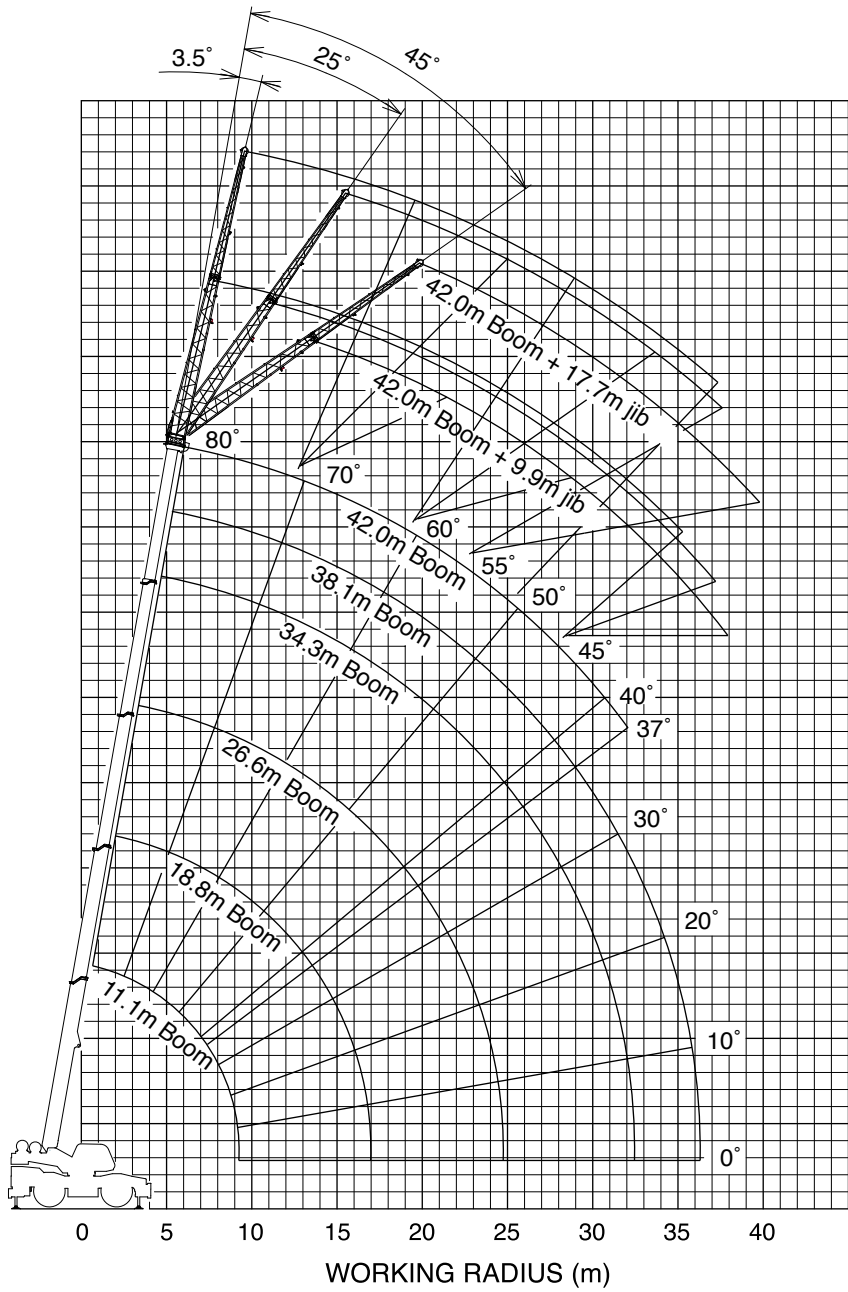

Boom Length

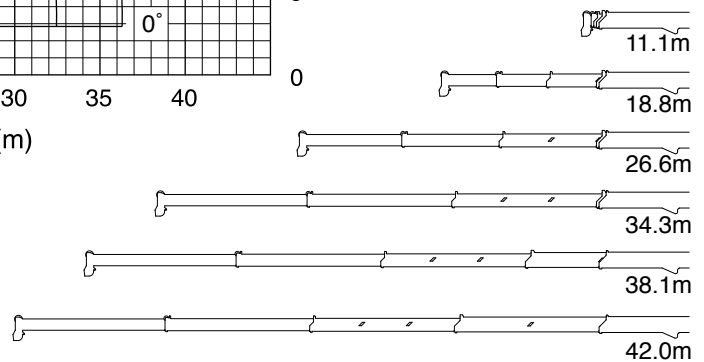

NOTE: The above lifting height and boom angle are based on a straight (unladen) boom, and allowance should be made for boom deflection obtained under laden conditions. The above working range is shown on condition with outriggers fully (7.2m) extended.

RATED LIFTING CAPACITIES ISO4305

SPEC. SHEET NO. GR-550E-1-00212/EX-12

ON OUTRIGGERS

Unit : kg

Outrigger fully extended (7.2m) 360° Rotation														
B \ A	11.1		15.0		18.8		26.6		34.3		38.1		42.0	
	C		C		C		C		C		C		C	
3.0	67.5	55,000	73.7	40,800	77.4	30,000	76.9	22,000						
3.5	64.4	53,400	71.7	40,800	75.9	30,000	75.4	22,000						
4.0	61.3	48,400	69.6	40,800	74.4	30,000	74.0	22,000	79.8	22,000	79.5	14,000		
4.5	58.3	43,800	67.5	40,800	72.8	30,000	72.3	22,000	78.7	22,000	78.4	14,000		
5.0	55.0	39,800	65.4	38,900	71.3	29,000	70.8	22,000	77.8	22,000	77.5	14,000		
5.5	51.8	36,000	63.2	35,600	69.6	27,200	69.1	22,000	76.7	21,500	76.3	13,600		
6.0	48.3	32,800	60.9	32,400	67.9	25,000	67.5	21,600	75.6	20,000	75.2	12,800	79.3	14,000
6.5	44.5	30,100	58.7	29,700	66.2	23,400	65.8	20,800	74.5	18,900	74.2	12,000	78.5	14,000
7.0	40.5	27,800	56.3	27,400	64.4	22,000	64.1	20,100	73.2	17,800	73.0	11,400	77.7	13,500
8.0	31.4	23,600	51.4	23,100	60.9	19,500	60.7	18,800	71.0	15,800	70.8	10,300	76.0	12,500
9.0	15.8	17,500	46.1	18,700	57.2	17,000	56.9	17,700	68.6	14,300	68.4	9,300	74.2	11,300
10.0			40.0	15,200	53.3	14,500	53.1	16,000	66.3	13,000	66.0	8,500	72.5	10,400
11.0			33.2	12,400	49.2	12,000	48.9	14,200	63.8	11,800	63.6	7,800	70.7	9,600
12.0			24.9	10,500	44.8	10,000	44.5	12,300	61.2	10,800	61.0	7,200	68.9	8,800
13.0			10.3	8,900	39.8	8,500	39.6	10,700	58.7	9,500	58.5	6,700	67.0	8,200
14.0					34.8	7,200	34.0	9,300	55.8	8,200	55.8	6,200	65.3	7,600
15.0					28.4	6,100	27.8	8,200	53.2	7,200	53.2	5,800	63.4	7,000
16.0					20.4	5,200	20.0	7,300	50.2	6,300	50.3	5,500	61.3	6,500
17.0									47.1	5,500	47.2	5,300	59.4	6,000
18.0									43.8	4,800	44.1	5,000	57.2	5,300
19.0									40.4	4,200	40.6	4,800	55.2	4,700
20.0									36.8	3,700	36.9	4,600	53.0	4,200
22.0									28.2	2,800	28.3	3,900	48.3	3,300
24.0									15.9	2,100	15.7	3,300	43.2	2,500
26.0													37.6	1,900
28.0													31.3	1,400
30.0													23.5	1,000
32.0													11.9	700
34.0														
36.0														
D	0°										37°			
Telescoping conditions (%)														
Telescoping Mode	I,II	I	I	II	I	II	I	II	II	I,II				
2nd boom	0	50	100	0	100	0	100	0	50	100				
3rd boom	0	0	0	33	33	66	66	100	100	100				
4th boom	0	0	0	33	33	66	66	100	100	100				
Top boom	0	0	0	33	33	66	66	100	100	100				

- A: Boom length (m)
- B: Load radius (m)
- C: Loaded boom angle (°)
- D: Minimum boom angle for indicated length (no load)

RATED LIFTING CAPACITIES ISO4305

SPEC. SHEET NO. GR-550E-1-00212/EX-12

ON OUTRIGGERS

Unit : kg

Outriggers fully extended (7.2m)												
360° Rotation												
C	42.0m Boom + 9.9m Jib						42.0m Boom + 17.7m Jib					
	3.5° offset		25° offset		45° offset		3.5° offset		25° offset		45° offset	
	R	W	R	W	R	W	R	W	R	W	R	W
80°	9.6	4,000	13.0	3,500	14.9	3,000	12.0	2,700	18.1	2,000	22.4	1,400
75°	14.9	4,000	17.7	3,000	19.1	2,500	18.1	2,600	23.3	1,600	27.1	1,300
70°	19.3	3,100	22.1	2,400	23.2	2,100	23.2	1,900	27.9	1,300	31.2	1,100
65°	23.5	2,400	26.2	2,000	27.2	1,800	28.2	1,500	32.1	1,000	34.8	900
60°	27.4	2,000	29.9	1,600	30.9	1,500	32.6	1,200	36.3	900	38.4	800
55°	30.9	1,600	33.3	1,400	34.0	1,300	36.5	900	40.0	700	41.8	700
50°	34.0	1,000	36.2	900	36.7	900	39.9	500				
45°	37.1	600	38.9	500	39.2	500						

Outriggers fully extended (7.2m)												
360° Rotation												
C	34.3m Boom (telescoping mode I) + 9.9m Jib						34.3m Boom (telescoping mode I) + 17.7m Jib					
	3.5° offset		25° offset		45° offset		3.5° offset		25° offset		45° offset	
	R	W	R	W	R	W	R	W	R	W	R	W
80°	7.6	5,600	11.4	4,700	13.7	3,400	10.1	3,600	16.3	2,400	20.3	1,600
75°	11.9	5,600	15.1	4,000	17.3	3,100	15.2	3,600	20.7	2,100	24.3	1,500
70°	15.7	4,800	18.7	3,400	20.5	2,800	19.7	3,000	24.7	1,800	27.8	1,400
65°	19.2	3,800	21.9	2,900	23.5	2,500	23.8	2,400	28.5	1,600	31.1	1,300
60°	22.5	3,200	25.1	2,500	26.3	2,300	27.7	2,000	32.0	1,400	34.1	1,200
55°	25.6	2,700	27.9	2,200	28.9	2,100	31.3	1,600	35.2	1,300	36.7	1,100
50°	28.4	2,000	30.5	1,800	31.3	1,700	34.5	1,200	38.0	1,000	39.1	1,000
45°	31.0	1,400	32.9	1,300	33.3	1,200	37.5	800	40.5	700	41.1	600
40°	33.4	1,000	35.0	900			40.3	500				
35°	35.7	700	36.9	600								

Outriggers fully extended (7.2m)												
360° Rotation												
C	38.1m Boom (telescoping mode II) + 9.9m Jib						38.1m Boom (telescoping mode II) + 17.7m Jib					
	3.5° offset		25° offset		45° offset		3.5° offset		25° offset		45° offset	
	R	W	R	W	R	W	R	W	R	W	R	W
80°	8.9	4,500	12.7	4,100	14.8	3,100	10.9	2,800	17.7	2,200	21.7	1,500
75°	13.8	4,500	16.7	3,200	18.6	2,600	16.6	2,800	22.3	1,800	25.9	1,300
70°	17.7	3,400	20.6	2,600	22.2	2,200	21.3	2,100	26.5	1,400	29.7	1,100
65°	21.5	2,600	24.2	2,100	25.6	1,800	25.8	1,600	30.5	1,100	33.3	1,000
60°	25.1	2,100	27.6	1,700	28.8	1,600	30.0	1,300	34.3	900	36.4	800
55°	28.4	1,700	30.8	1,500	31.7	1,400	33.9	1,000	37.8	800	39.3	700
50°	31.5	1,400	33.6	1,300	34.2	1,200	37.6	800	41.0	700	42.0	600
45°	34.4	1,200	36.2	1,100	36.5	1,000	41.1	600	43.9	600	44.5	500
40°	36.9	800	38.5	800								
35°	39.3	500	40.6	500								

C: Boom angle

R: Load radius (m)

W: Rated lifting capacity

RATED LIFTING CAPACITIES ISO4305

SPEC. SHEET NO. GR-550E-1-00212/EX-12

ON OUTRIGGERS

Unit : kg

Outrigger extended to middle (6.7m) 360° Rotation														
B \ A	11.1		15.0		18.8		26.6		34.3		38.1		42.0	
	C		C		C		C		C		C		C	
3.0	67.5	55,000	73.7	40,800	77.4	30,000	76.9	22,000						
3.5	64.4	53,400	71.7	40,800	75.9	30,000	75.4	22,000						
4.0	61.3	48,400	69.6	40,800	74.4	30,000	74.0	22,000	79.8	22,000	79.5	14,000		
4.5	58.3	43,800	67.5	40,800	72.8	30,000	72.3	22,000	78.7	22,000	78.4	14,000		
5.0	55.0	39,800	65.4	38,900	71.3	29,000	70.8	22,000	77.8	22,000	77.5	14,000		
5.5	51.8	36,000	63.2	35,600	69.6	27,200	69.1	22,000	76.7	21,500	76.3	13,600		
6.0	48.3	32,800	60.9	32,400	67.9	25,000	67.5	21,600	75.6	20,000	75.2	12,800	79.3	14,000
6.5	44.5	30,100	58.7	29,700	66.2	23,400	65.8	20,800	74.5	18,900	74.2	12,000	78.5	14,000
7.0	40.5	27,200	56.3	26,300	64.4	22,000	64.1	20,100	73.2	17,800	73.0	11,400	77.7	13,500
8.0	31.1	20,700	51.4	20,200	60.7	19,400	60.7	18,800	71.0	15,800	70.8	10,300	76.0	12,500
9.0	15.4	15,800	46.1	16,000	57.1	15,600	56.9	17,700	68.6	14,300	68.4	9,300	74.2	11,300
10.0			40.0	13,000	53.2	12,700	53.1	15,300	66.3	13,000	66.0	8,500	72.5	10,400
11.0			33.2	11,000	48.9	10,500	48.9	12,700	63.8	11,500	63.6	7,800	70.7	9,600
12.0			24.9	9,200	44.7	8,700	44.5	11,000	61.2	10,000	61.0	7,200	68.9	8,800
13.0			10.3	7,600	39.5	7,200	39.6	9,400	58.5	8,500	58.5	6,700	67.0	8,200
14.0					34.3	6,000	34.0	8,200	55.8	7,300	55.8	6,200	65.3	7,600
15.0					28.2	5,000	27.8	7,400	53.0	6,400	53.2	5,800	63.3	6,800
16.0					20.2	4,200	20.0	6,500	50.1	5,600	50.3	5,500	61.3	6,000
17.0									47.0	4,800	47.2	5,300	59.1	5,200
18.0									43.7	4,200	44.1	5,000	57.2	4,600
19.0									40.3	3,600	40.6	4,800	54.9	4,000
20.0									36.6	3,100	36.9	4,300	52.8	3,500
22.0									27.8	2,300	28.1	3,400	48.1	2,800
24.0									15.3	1,700	15.4	2,700	43.0	2,000
26.0													37.5	1,500
28.0													31.1	1,000
30.0													23.4	700
32.0													11.6	1,300
D	0°								19°	0°	22°	38°		
Telescoping conditions (%)														
Telescoping Mode	I,II	I	I	II	I	II	I	II	II	I,II				
2nd boom	0	50	100	0	100	0	100	0	50	100				
3rd boom	0	0	0	33	33	66	66	100	100	100				
4th boom	0	0	0	33	33	66	66	100	100	100				
Top boom	0	0	0	33	33	66	66	100	100	100				

A: Boom length (m)

B: Load radius (m)

C: Loaded boom angle (°)

D: Minimum boom angle for indicated length (no load)

RATED LIFTING CAPACITIES ISO4305

SPEC. SHEET NO. GR-550E-1-00212/EX-12

ON OUTRIGGERS

Unit : kg

Outrigger extended to middle (6.7m) 360° Rotation												
C	42.0m Boom + 9.9m Jib						42.0m Boom + 17.7m Jib					
	3.5° offset		25° offset		45° offset		3.5° offset		25° offset		45° offset	
	R	W	R	W	R	W	R	W	R	W	R	W
80°	9.6	4,000	13.0	3,500	14.9	3,000	12.0	2,700	18.1	2,000	22.4	1,400
75°	14.9	4,000	17.7	3,000	19.1	2,500	18.1	2,600	23.3	1,600	27.1	1,300
70°	19.3	3,100	22.1	2,400	23.2	2,100	23.2	1,900	27.9	1,300	31.2	1,100
65°	23.5	2,400	26.2	2,000	27.2	1,800	28.2	1,500	32.1	1,000	34.8	900
60°	27.4	2,000	29.9	1,600	30.9	1,500	32.6	1,200	36.3	900	38.4	800
55°	30.7	1,300	33.2	1,200	33.9	1,100	36.3	700	39.8	500	41.6	500
50°	33.9	800	36.1	700	36.6	700						

Outrigger extended to middle (6.7m) 360° Rotation												
C	34.3m Boom (telescoping mode I) + 9.9m Jib						34.3m Boom (telescoping mode I) + 17.7m Jib					
	3.5° offset		25° offset		45° offset		3.5° offset		25° offset		45° offset	
	R	W	R	W	R	W	R	W	R	W	R	W
80°	7.6	5,600	11.4	4,700	13.7	3,400	10.1	3,600	16.3	2,400	20.3	1,600
75°	11.9	5,600	15.1	4,000	17.3	3,100	15.2	3,600	20.7	2,100	24.3	1,500
70°	15.7	4,800	18.7	3,400	20.5	2,800	19.7	3,000	24.7	1,800	27.8	1,400
65°	19.2	3,800	21.9	2,900	23.5	2,500	23.8	2,400	28.5	1,600	31.1	1,300
60°	22.5	3,200	25.1	2,500	26.3	2,300	27.7	2,000	32.0	1,400	34.1	1,200
55°	25.6	2,400	27.9	2,100	28.9	2,000	31.3	1,600	35.2	1,300	36.7	1,100
50°	28.3	1,600	30.5	1,500	31.2	1,400	34.5	1,000	37.9	800	39.0	700
45°	31.0	1,100	32.8	1,000	33.3	1,000	37.5	600	40.4	500		
40°	33.3	700	34.9	600								

Outrigger extended to middle (6.7m) Rotation												
C	38.1m Boom (telescoping mode II) + 9.9m Jib						38.1m Boom (telescoping mode II) + 17.7m Jib					
	3.5° offset		25° offset		45° offset		3.5° offset		25° offset		45° offset	
	R	W	R	W	R	W	R	W	R	W	R	W
80°	8.9	4,500	12.7	4,100	14.8	3,100	10.9	2,800	17.7	2,200	21.7	1,500
75°	13.8	4,500	16.7	3,200	18.6	2,600	16.6	2,800	22.3	1,800	25.9	1,300
70°	17.7	3,400	20.6	2,600	22.2	2,200	21.3	2,100	26.5	1,400	29.7	1,100
65°	21.5	2,600	24.2	2,100	25.6	1,800	25.8	1,600	30.5	1,100	33.3	1,000
60°	25.1	2,100	27.6	1,700	28.8	1,600	30.0	1,300	34.3	900	36.4	800
55°	28.4	1,700	30.8	1,500	31.7	1,400	33.9	1,000	37.8	800	39.3	700
50°	31.5	1,400	33.6	1,300	34.2	1,200	37.6	800	41.0	700	42.0	600
45°	34.3	900	36.1	800	36.4	800						
40°	36.8	500	38.3	500								

C: Boom angle

R: Load radius (m)

W: Rated lifting capacity

RATED LIFTING CAPACITIES ISO4305

SPEC. SHEET NO. GR-550E-1-00212/EX-12

ON OUTRIGGERS

Unit : kg

Outrigger extended to middle (5.5m)																
360° Rotation																
B \ A	11.1		15.0		18.8		26.6		34.3		38.1		42.0			
	C	C	C	C	C	C	C	C	C	C	C	C	C	C		
3.0	67.5	55,000	73.7	40,800	77.4	30,000	76.9	22,000								
3.5	64.4	53,400	71.7	40,800	75.9	30,000	75.4	22,000								
4.0	61.3	48,400	69.6	40,800	74.4	30,000	74.0	22,000	79.8	22,000	79.5	14,000				
4.5	58.3	43,800	67.5	39,000	72.8	30,000	72.3	22,000	78.7	22,000	78.4	14,000				
5.0	55.0	37,600	65.4	32,700	71.3	29,000	70.8	22,000	77.8	22,000	77.5	14,000				
5.5	51.8	30,500	63.2	28,000	69.6	25,100	69.1	22,000	76.7	21,500	76.3	13,600				
6.0	48.3	26,000	60.9	24,300	67.9	21,900	67.5	21,600	75.6	20,000	75.2	12,800	79.3	14,000		
6.5	44.5	22,000	58.5	21,400	66.2	19,400	65.8	20,800	74.5	18,300	74.2	12,000	78.5	14,000		
7.0	40.5	19,400	56.2	18,600	64.4	17,200	64.1	20,100	73.2	16,500	73.0	11,400	77.7	13,600		
8.0	31.1	15,000	51.3	14,500	60.7	13,600	60.5	16,500	70.9	13,700	70.8	10,300	76.0	12,500		
9.0	15.2	11,600	45.9	11,500	56.9	11,000	56.8	13,300	68.4	11,500	68.4	9,300	74.2	11,100		
10.0			40.0	9,300	53.1	9,000	52.9	11,100	65.9	9,800	66.0	8,500	72.4	9,500		
11.0			33.2	7,700	48.9	7,300	48.8	9,300	63.5	8,400	63.6	7,800	70.6	8,300		
12.0			24.9	6,400	44.6	6,000	44.3	7,900	60.9	7,100	61.0	7,200	68.7	7,200		
13.0			10.3	5,300	39.5	4,800	39.6	6,800	58.3	6,100	58.5	6,700	66.8	6,400		
14.0					34.3	3,900	33.9	5,900	55.5	5,200	55.8	6,200	64.8	5,600		
15.0					28.2	3,200	27.8	5,100	52.8	4,400	53.0	5,600	63.0	4,900		
16.0					20.2	2,500	19.8	4,300	49.8	3,700	50.2	4,900	60.9	4,200		
17.0									46.7	3,100	46.9	4,300	58.9	3,600		
18.0									43.5	2,600	43.7	3,800	56.8	3,100		
19.0									40.0	2,100	40.4	3,300	54.8	2,600		
20.0									36.2	1,700	36.6	2,900	52.4	2,200		
22.0									27.7	1,100	27.9	2,200	47.8	1,500		
24.0											15.3	1,700	42.7	1,000		
26.0													37.6	1,500		
28.0													31.3	1,100		
30.0													23.4	800		
D	0°				13°		0°		38°		19°		37°		47°	
Telescoping conditions (%)																
Telescoping Mode	I,II	I	I	II	I	II	I	II	I	II	II	II	I,II			
2nd boom	0	50	100	0	100	0	100	0	100	0	50	100				
3rd boom	0	0	0	33	33	66	66	100	100	100	100	100				
4th boom	0	0	0	33	33	66	66	100	100	100	100	100				
Top boom	0	0	0	33	33	66	66	100	100	100	100	100				

- A: Boom length (m)
- B: Load radius (m)
- C: Loaded boom angle (°)
- D: Minimum boom angle for indicated length (no load)

RATED LIFTING CAPACITIES ISO4305

SPEC. SHEET NO. GR-550E-1-00212/EX-12

ON OUTRIGGERS

Unit : kg

Outrigger extended to middle (5.5m) 360° Rotation												
C	42.0m Boom + 9.9m Jib						42.0m Boom + 17.7m Jib					
	3.5° offset		25° offset		45° offset		3.5° offset		25° offset		45° offset	
	R	W	R	W	R	W	R	W	R	W	R	W
80°	9.6	4,000	13.0	3,500	14.9	3,000	12.0	2,700	18.1	2,000	22.4	1,400
75°	14.9	4,000	17.7	3,000	19.1	2,500	18.1	2,600	23.3	1,600	27.1	1,300
70°	19.3	3,100	22.1	2,400	23.2	2,100	23.2	1,900	27.9	1,300	31.2	1,100
65°	23.2	2,100	25.9	1,700	27.1	1,600	27.9	1,300	32.1	1,000	34.8	800
60°	26.8	1,200	29.5	1,000	30.5	900	31.7	500				
55°	30.2	500	32.7	500								

Outrigger extended to middle (5.5m) 360° Rotation												
C	34.3m Boom (telescoping mode I) + 9.9m Jib						34.3m Boom (telescoping mode I) + 17.7m Jib					
	3.5° offset		25° offset		45° offset		3.5° offset		25° offset		45° offset	
	R	W	R	W	R	W	R	W	R	W	R	W
80°	7.6	5,600	11.4	4,700	13.7	3,400	10.1	3,600	16.3	2,400	20.3	1,600
75°	11.9	5,600	15.1	4,000	17.3	3,100	15.2	3,600	20.7	2,100	24.3	1,500
70°	15.7	4,800	18.7	3,400	20.5	2,800	19.7	3,000	24.7	1,800	27.8	1,400
65°	19.1	3,500	21.9	2,900	23.5	2,500	23.8	2,400	28.5	1,600	31.1	1,300
60°	22.2	2,300	24.8	1,900	26.2	1,800	27.3	1,400	31.8	1,100	33.9	900
55°	25.3	1,400	27.6	1,200	28.7	1,100	30.6	800	34.7	600	36.5	500
50°	28.1	800	30.2	700	31.0	600						

Outrigger extended to middle (5.5m) 360° Rotation												
C	38.1m Boom (telescoping mode II) + 9.9m Jib						38.1m Boom (telescoping mode II) + 17.7m Jib					
	3.5° offset		25° offset		45° offset		3.5° offset		25° offset		45° offset	
	R	W	R	W	R	W	R	W	R	W	R	W
80°	8.9	4,500	12.7	4,100	14.8	3,100	10.9	2,800	17.7	2,200	21.7	1,500
75°	13.8	4,500	16.7	3,200	18.6	2,600	16.6	2,800	22.3	1,800	25.9	1,300
70°	17.7	3,400	20.6	2,600	22.2	2,200	21.3	2,100	26.5	1,400	29.7	1,100
65°	21.5	2,600	24.2	2,100	25.6	1,800	25.8	1,600	30.5	1,100	33.3	1,000
60°	25.1	2,000	27.6	1,700	28.8	1,600	29.7	1,200	34.3	900	36.4	800
55°	28.2	1,200	30.5	1,100	31.4	1,000	33.3	600	37.5	500	39.2	500
50°	31.0	600	33.2	600	33.9	600						

C: Boom angle

R: Load radius (m)

W: Rated lifting capacity

RATED LIFTING CAPACITIES ISO4305

SPEC. SHEET NO. GR-550E-1-00212/EX-12

ON OUTRIGGERS

Unit : kg

Outrigger extended to minimum (2.8m) 360° Rotation																				
B	A	11.1m		15.0m		18.8m		26.6m		34.3m		38.1m		42.0m						
		C		C		C		C		C		C		C						
3.0	67.2	27,600	73.5	23,400	77.1	20,300	76.9	22,000												
3.5	64.1	22,400	71.5	19,200	75.5	16,800	75.3	19,600												
4.0	61.2	18,600	69.3	16,000	73.9	14,100	73.7	16,800	79.3	13,100	79.5	14,000								
4.5	58.2	15,500	67.2	13,600	72.3	12,000	72.1	14,600	78.2	11,400	78.4	13,200								
5.0	55.0	13,200	65.1	11,700	70.7	10,300	70.5	12,800	77.0	10,000	77.2	11,700								
5.5	51.6	11,000	62.9	10,100	69.1	8,900	68.9	11,300	76.0	8,800	76.0	10,500								
6.0	48.1	9,500	60.7	8,800	67.4	7,800	67.2	10,100	74.8	7,800	74.9	9,400	78.8	7,500	78.9	8,000				
6.5	44.4	8,000	58.4	7,700	65.7	6,800	65.5	9,100	73.7	7,000	73.8	8,500	77.9	6,700	78.1	7,900				
7.0	40.2	7,000	56.0	6,800	64.1	5,900	63.8	8,200	72.6	6,200	72.6	7,800	77.0	6,100	77.2	7,200	79.0	6,500		
8.0	30.6	5,300	51.2	5,100	60.6	4,500	60.3	6,700	70.3	5,000	70.3	6,500	75.3	4,900	75.5	6,100	77.4	5,400	78.5	4,800
9.0	15.2	4,000	45.9	3,700	56.8	3,400	56.6	5,400	67.8	4,000	67.9	5,500	73.6	4,100	73.7	5,200	75.8	4,500	77.1	4,000
10.0			39.9	2,700	52.9	2,400	52.7	4,300	65.3	3,200	65.5	4,600	71.8	3,300	71.9	4,400	74.3	3,800	75.7	3,300
11.0			32.9	1,800	48.8	1,600	48.7	3,400	63.0	2,500	62.9	3,900	70.0	2,700	70.1	3,800	72.5	3,200	74.4	2,700
12.0			24.5	1,100	44.5	900	44.0	2,700	60.5	1,900	60.4	3,200	68.2	2,200	68.3	3,300	70.9	2,700	73.0	2,300
13.0							39.2	2,100	57.9	1,400	57.8	2,600	66.4	1,700	66.3	2,800	69.2	2,300	71.6	1,800
14.0							33.6	1,600	55.1	1,000	55.0	2,100	64.6	1,300	64.5	2,400	67.4	1,900	70.3	1,500
15.0							27.5	1,200			52.2	1,700	62.6	1,000	62.5	1,900	65.8	1,600	68.9	1,200
16.0							19.3	800			49.4	1,300	60.5	700	60.5	1,600	64.1	1,300	67.5	900
17.0											46.4	1,200			58.6	1,300	62.2	1,000		
18.0											43.1	700			56.4	1,000	60.3	700		
19.0															54.2	700				
D	0°		12°		42°		10°		52°		41°		60°		54°		59°		66°	
Telescoping conditions (%)																				
Telescoping Mode	I,II	I	I	I	II	I	II	I	II	I	II	I	II	II	I,II					
2nd boom	0	50	100	0	100	0	100	0	100	0	100	0	50	100	100					
3rd boom	0	0	0	33	33	66	66	66	100	100	100	100	100	100	100					
4th boom	0	0	0	33	33	66	66	66	100	100	100	100	100	100	100					
Top boom	0	0	0	33	33	66	66	66	100	100	100	100	100	100	100					

- A : Boom length (m)
- B : Load radius (m)
- C : Loaded boom angle (°)
- D : Minimum boom angle for indicated length (no load)

NOTES FOR "ON OUTRIGGERS" TABLE

- Rated lifting capacities shown in the table are based on condition that crane is set on firm level surface. Those above bold lines are based on crane strength and those below, on its stability.
- Rated lifting capacities based on crane stability are according to ISO 4305.
- The mass of the hook (570 kg for 55 t capacity, 470 kg for 40 t capacity, 400 kg for 20 t capacity, 150 kg for 5.6 t capacity), slings and all similarly used load handling devices must be considered as part of the load and must be deducted from the lifting capacities.
- For rated lifting capacity of single top, reduce the rated lifting capacities of relevant boom according to a weight reduction for auxiliary load handling equipment. Capacities of single top shall not exceed 5,600 kg including main hook.
- Standard number of parts of line for each boom length is as shown below. Load per line should not surpass 54.9 kN {5,600 kgf} for main winch and auxiliary winch.

Boom length	11.1m	11.1m to 15.0m	15.0m to 18.8m	18.8m to 42.0m	Single top / Jib
Number of parts of line	11	8	6	4	1

The lifting capacity data stored in the AUTOMATIC MOMENT LIMITER (AML-L) is based on the standard number of parts of line listed in the chart.

Maximum lifting capacity is restricted by the number of parts of line of AUTOMATIC MOMENT LIMITER (AML-L).

- The lifting capacity for over-side area differs depending on the outrigger extension width. Work with the capacity corresponding to the extension width. The lifting capacities for over-front and over-rear areas are for "outriggers fully extended". However, the areas (angle a) differ depending on the outrigger extension width.

Outriggers extended width	6.7m (middle)	5.5m (middle)	2.8m (minimum)
Angle a°	45	15	5

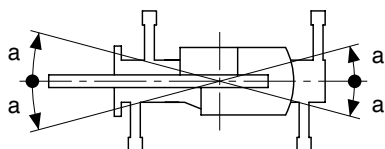

RATED LIFTING CAPACITIES ISO4305

ON TIRES

Unit : kg

A B		Stationary																						
		Over Front								360° Rotation														
		11.1m		15.0m		18.8m		26.6m		11.1m		15.0m		18.8m		26.6m								
C	C	C	C	C	C	C	C	C	C	C	C	C	C	C	C									
3.0	67.2	29,500	73.4	22,000					67.2	17,700	73.4	16,300												
3.5	64.3	27,200	71.4	22,000					64.3	14,800	71.4	14,200												
4.0	61.3	24,600	69.3	20,500	73.7	15,500			61.3	12,500	69.3	12,100	73.7	9,800										
4.5	58.3	22,200	67.2	19,600	72.1	15,500			58.3	10,600	67.2	10,100	72.1	9,800										
5.0	55.0	20,000	65.1	18,200	70.5	15,000			55.0	9,100	65.1	8,700	70.5	8,600										
5.5	51.7	17,500	63.0	16,400	68.8	14,400			51.7	7,700	63.0	7,500	68.8	7,300										
6.0	48.1	15,300	60.7	14,300	67.2	13,700	74.9	9,400	48.1	6,600	60.7	6,300	67.2	6,100	74.9	6,700								
6.5	44.4	13,500	58.4	12,600	65.5	12,800	73.9	9,400	44.4	5,600	58.4	5,300	65.5	5,200	73.9	5,800								
7.0	40.4	11,900	56.0	11,100	63.8	11,200	72.8	9,400	40.4	4,800	56.0	4,500	63.8	4,400	72.8	5,200								
8.0	30.7	9,300	51.1	8,700	60.2	8,700	70.6	9,000	30.7	3,600	51.1	3,200	60.2	3,200	70.6	4,100								
9.0	15.3	7,600	45.7	7,000	56.6	6,800	68.2	7,800	15.3	2,600	45.7	2,200	56.6	2,100	68.2	3,000								
10.0			39.8	5,600	52.7	5,500	65.6	6,500			39.8	1,400	52.7	1,300	65.6	2,200								
11.0			32.7	4,700	48.6	4,500	63.2	5,300			32.7	800	48.6	600	62.6	1,500								
12.0			24.4	3,800	44.1	3,600	60.6	4,500							60.1	1,000								
13.0			10.4	3,000	39.3	2,800	58.0	3,800																
14.0					33.6	2,200	55.3	3,200																
15.0					27.7	1,600	52.5	2,700																
16.0					19.1	1,000	49.6	2,200																
17.0							46.4	1,800																
18.0							43.1	1,400																
19.0							39.7	1,100																
20.0							36.0	800																
D	0°				32°				0°				29°				48°				58°			
Telescoping conditions (%)																								
Telescoping Mode	I,II	I	II	I	II	I	II	I,II	I	II	I	II	I	II	I	II								
2nd boom	0	50	0	100	0	100	0	0	50	0	100	0	100	0	0									
3rd boom	0	0	16	0	33	33	66	0	0	16	0	33	33	66	66									
4th boom	0	0	16	0	33	33	66	0	0	16	0	33	33	66	66									
Top boom	0	0	16	0	33	33	66	0	0	16	0	33	33	66	66									

- A: Boom length (m)
- B: Load radius (m)
- C: Loaded boom angle (°)
- D: Minimum boom angle for indicated length (no load)

ON TIRES

Unit : kg

A B		CREEP																						
		Over Front								360° Rotation														
		11.1m		15.0m		18.8m		26.6m		11.1m		15.0m		18.8m		26.6m								
C	C	C	C	C	C	C	C	C	C	C	C	C	C	C	C									
3.0	67.2	22,700	73.4	21,300					67.2	17,000	73.4	16,300												
3.5	64.3	20,200	71.4	19,200					64.3	14,800	71.4	14,200												
4.0	61.3	18,200	69.3	17,300	73.7	15,000			61.3	12,200	69.3	11,700	73.7	9,800										
4.5	58.3	16,500	67.2	15,800	72.1	15,000			58.3	10,000	67.2	9,600	72.1	9,300										
5.0	55.0	15,100	65.1	14,400	70.5	14,100			55.0	8,200	65.1	8,000	70.5	7,700										
5.5	51.7	13,600	63.0	13,200	68.8	13,000			51.7	7,000	63.0	6,600	68.8	6,400										
6.0	48.1	12,400	60.7	12,000	67.2	11,900	74.9	9,400	48.1	5,900	60.7	5,500	67.2	5,400	74.9	6,400								
6.5	44.4	11,400	58.4	11,000	65.5	11,000	73.9	9,400	44.4	5,000	58.4	4,700	65.5	4,600	73.5	5,500								
7.0	40.4	10,500	56.0	10,100	63.8	10,100	72.8	9,400	40.4	4,300	56.0	4,100	63.8	3,800	72.4	4,800								
8.0	30.7	8,500	51.1	8,100	60.2	7,900	70.6	8,600	30.7	3,100	51.1	2,800	60.2	2,700	70.0	3,600								
9.0	15.3	6,700	45.7	6,300	56.6	6,200	68.2	7,200	15.7	2,200	45.7	1,900	56.6	1,700	67.5	2,700								
10.0			39.8	5,100	52.7	4,900	65.6	5,900			39.8	1,200	52.7	1,100	65.1	1,900								
11.0			32.7	4,100	48.6	3,900	63.2	4,900							62.6	1,300								
12.0			24.4	3,300	44.1	3,100	60.6	4,000							60.1	800								
13.0			10.4	2,600	39.3	2,400	58.0	3,300																
14.0					33.6	1,800	55.3	2,700																
15.0					27.7	1,300	52.5	2,200																
16.0					19.1	900	49.6	1,800																
17.0							46.4	1,400																
18.0							43.1	1,000																
19.0							39.7	800																
D	0°				36°				0°				34°				50°				59°			
Telescoping conditions (%)																								
Telescoping Mode	I,II	I	II	I	II	I	II	I,II	I	II	I	II	I	II	I	II								
2nd boom	0	50	0	100	0	100	0	0	50	0	100	0	100	0	0									
3rd boom	0	0	16	0	33	33	66	0	0	16	0	33	33	66	66									
4th boom	0	0	16	0	33	33	66	0	0	16	0	33	33	66	66									
Top boom	0	0	16	0	33	33	66	0	0	16	0	33	33	66	66									

- A: Boom length (m)
- B: Load radius (m)
- C: Loaded boom angle (°)
- D: Minimum boom angle for indicated length (no load)

NOTES FOR “ON TIRES” TABLES

1. Rated lifting capacities shown in the table are based on condition that crane is set on firm level surface, with suspension lock applied. Those above bold lines are based on tire capacity and those below, on crane stability. They are based on actual working radii increased by tire deformation and boom deflection.
2. Rated lifting capacities based on crane stability are according to ISO 4305.
3. The mass of the hook (570 kg for 55t capacity, 470 kg for 40t capacity, 400 kg for 20t capacity, 150 kg for 5.6t capacity), slings and all similarly used load handling devices must be considered as part of the load and must be deducted from the lifting capacities.
4. For rated lifting capacity of single top, reduce the rated lifting capacities of relevant boom according to weight reductions for auxiliary load handling equipment. Capacities of single top shall not exceed 5,600 kg including main hook.
5. On tires lifting with "jib" is not permitted. Maximum permissible boom length is 26.6 m.
6. CREEP is motion for crane not to travel more than 60 m in any 30 minute period and to travel at the speed of less than 1.6 km/h.
7. During "CREEP" duties travel slowly and keep the lifting load as close to the ground as possible, and especially avoid any abrupt steering, accelerating or braking.
8. Do not operate the crane while carrying the load.
9. Tires should be inflated to their correct air pressure.

Tires	Air pressure
29.5-25 22PR	420 kPa (4.2kgf/cm ²)
29.5-25 28PR	450 kPa (4.5kgf/cm ²)

10. For CREEP operation, set Drive select switch to "4-WHEEL(Lo)" and set gear shift lever to "1".
11. Standard number of parts of line for on tires operation should be according to the following table.
Load per line should not surpass 54.9 kN {5,600 kgf} for main winch and auxiliary winch.

Boom length	Over Front		360° Rotation	
	11.1m	11.1m to 26.2m	11.1m	11.1m to 26.2m
Number of part of line (Single top)	6	4 (1)	4 (1)	4 (1)

The lifting capacity data stored in the AUTOMATIC MOMENT LIMITER (AML-L) is based on the standard number of parts of line listed in the chart. Maximum lifting capacity is restricted by the number of parts of line of AUTOMATIC MOMENT LIMITER (AML-L).

WORKING AREA

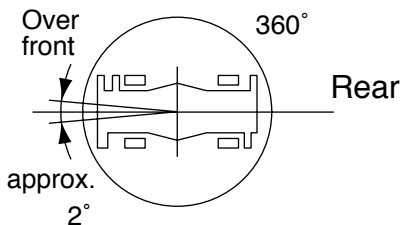

Without outriggers "Over front" operation should be performed within 2 degrees in front of chassis.

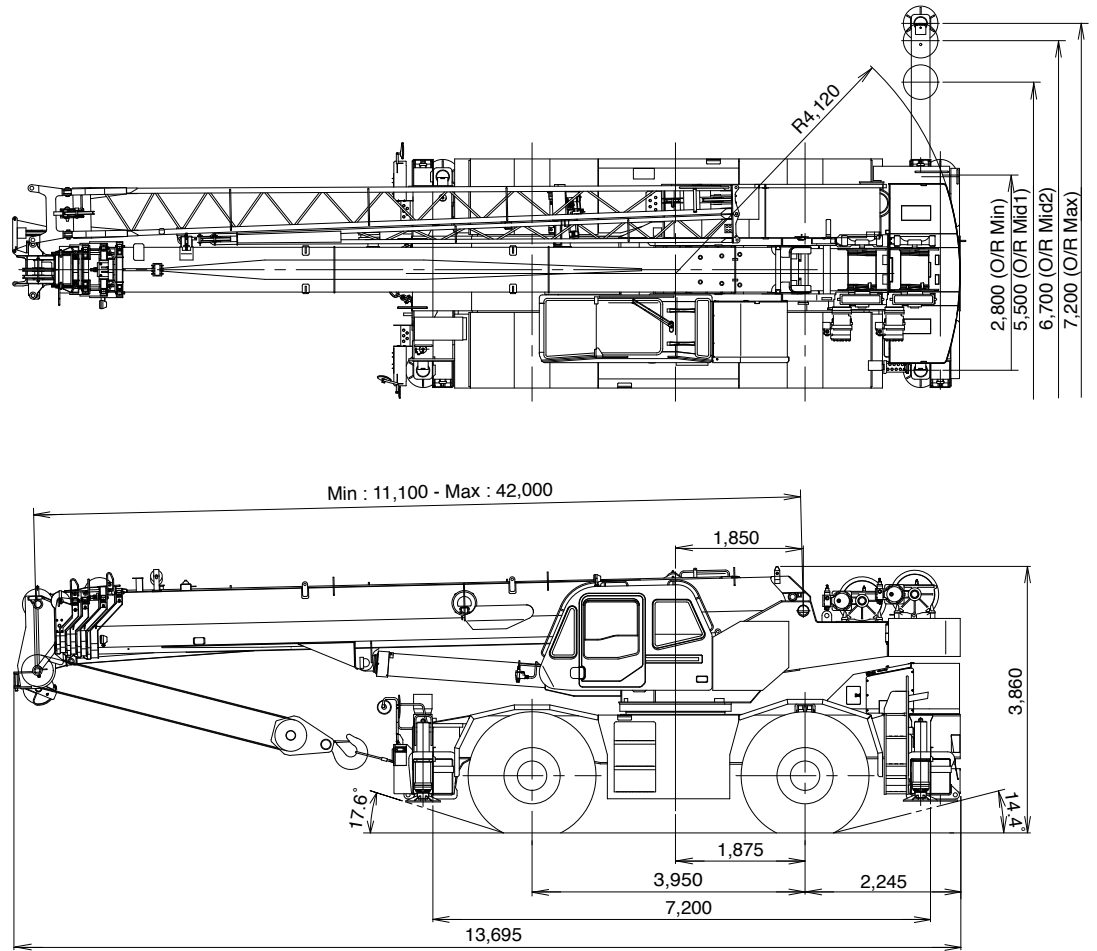

Note : Dimension is with boom angle at -1.4°

Axle Weight Distribution Chart

Unit : kg

	GVW	Front	Rear
Basic standard machine includes: 5-section boom (11.1 m - 42.0 m) 2-stage jib (9.9 m, 17.7 m) Mitsubishi 6M60-TLU3B Single top 5.6 ton hook block	43,050	23,080	19,970
Add:			
1. 55 ton 6 sheaves hook block	+570	+1,030	-460
2. 40 ton 4 sheaves hook block	+470	+850	-380
3. 20 ton 2 sheaves hook block	+400	+720	-320
4. Air conditioner	+100	+ 30	+ 70
Remove:			
1. 5.6 ton hook block	-150	-209	+ 59
2. Top jib (7.8 m)	-307	-367	+ 60
3. Base jib (9.9 m)	-831	-1,538	+707

Specifications are subject to change without notice.



TADANO

TADANO LTD. (International Division)

4-12, Kamezawa 2-chome,
Sumida-ku, Tokyo 130-0014, Japan

Tel : 81-(0)3-3621-7750

Fax : 81-(0)3-3621-7785

 <http://www.tadano.co.jp/indexe.htm>

 tdnihq@tadano.co.jp

Printed in Japan

GR-550E-2007-07-1