

Via dei Carmelitani, 2  
24021 Albino BG  
tel. ++39 35 776400  
fax ++39 35 755020  
www.fassigroup.com  
fassi@fassigroup.com

LOAD DIAGRAM WITH LIFTING MOMENT LIMITING DEVICE

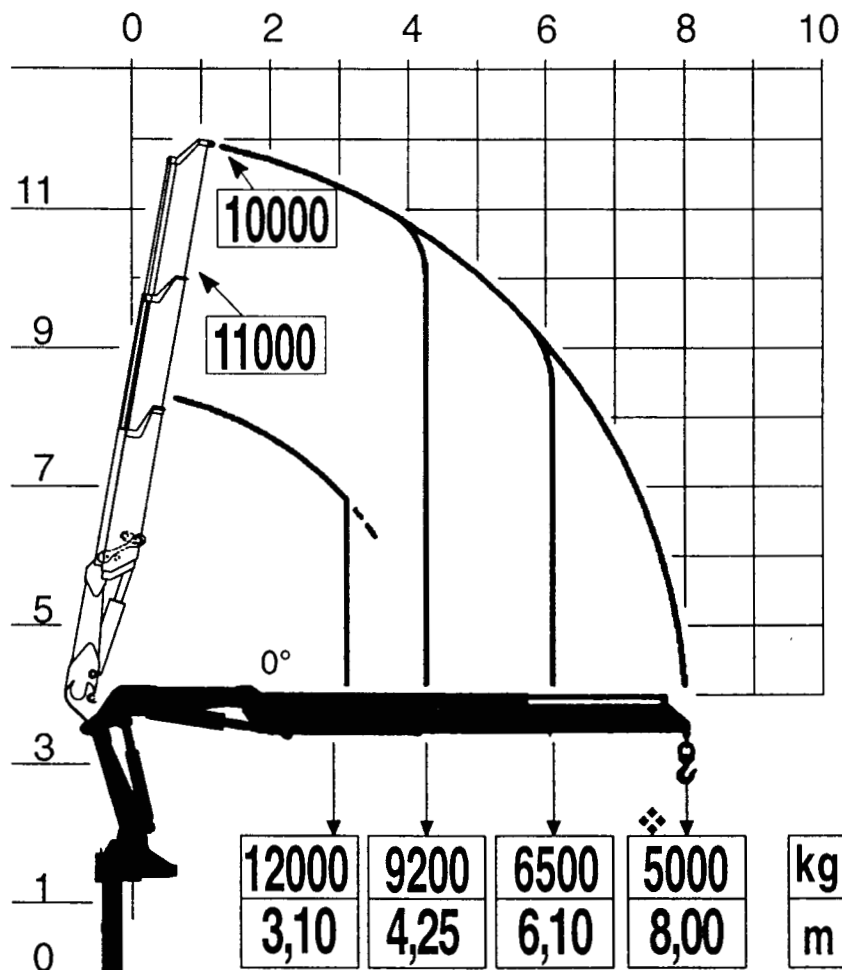

## FASSI

### F420AXP.22

❖ = Mmax 392 kNm

⚙ = Pmax 12.000 kg

⚙ = Pmax 3.850 kg

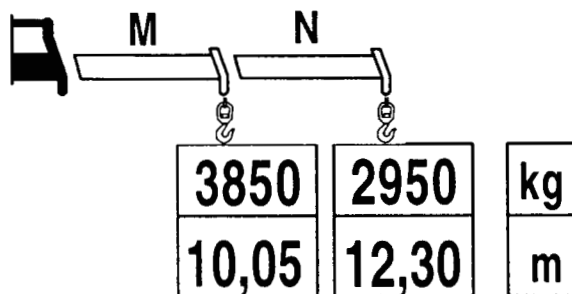

Via dei Carmelitani, 2  
24021 Albino BG  
tel. ++39 35 776400  
fax ++39 35 755020  
www.fassigroup.com  
fassi@fassigroup.com

LOAD DIAGRAM WITH LIFTING MOMENT LIMITING DEVICE

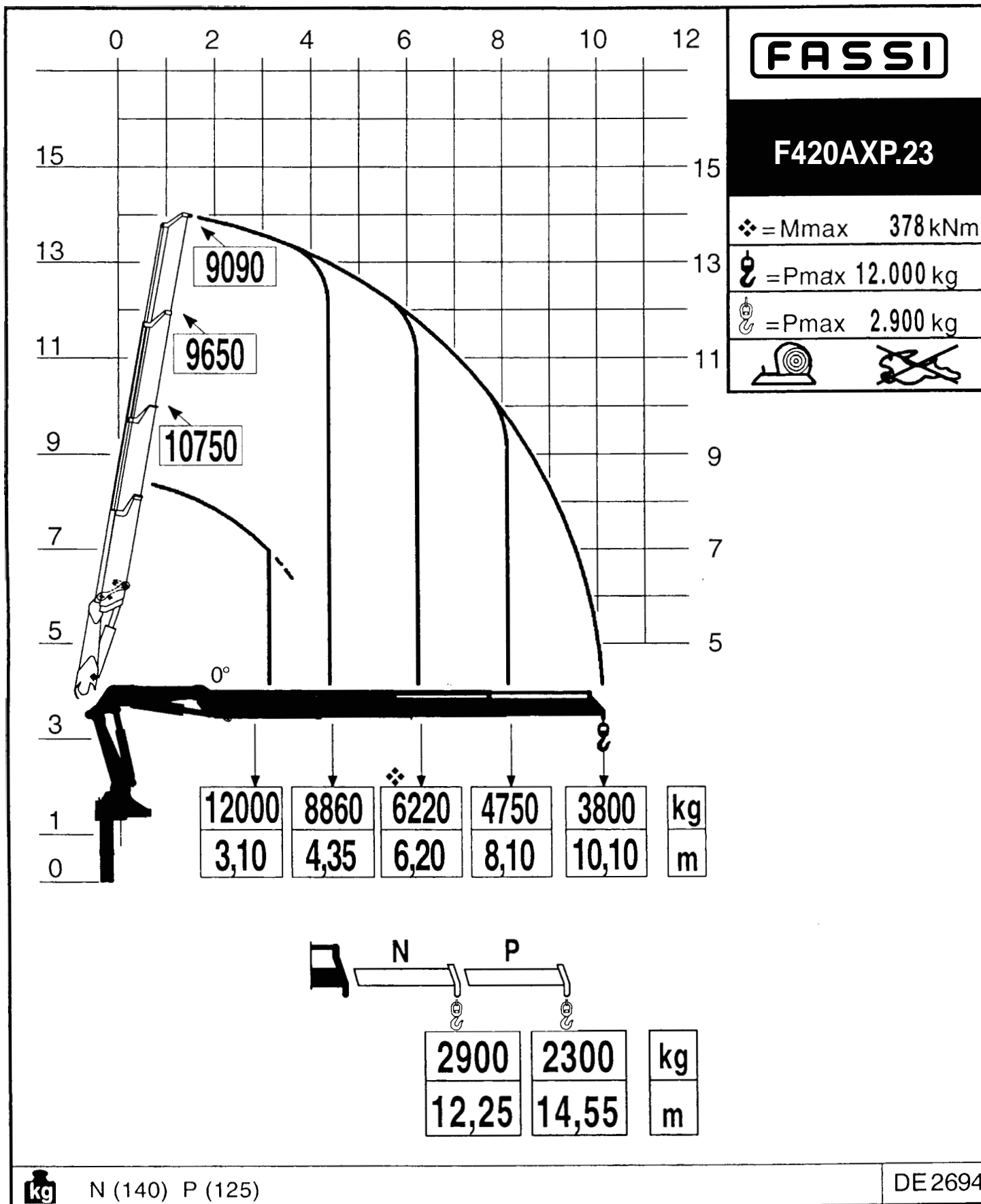

Via Roma, 110  
 24021 Albino BG  
 tel. ++39 35 776400  
 fax ++39 35 755020  
 www.fassigroup.com  
 fassi@fassigroup.com

LOAD DIAGRAM WITH LIFTING MOMENT LIMITING DEVICE

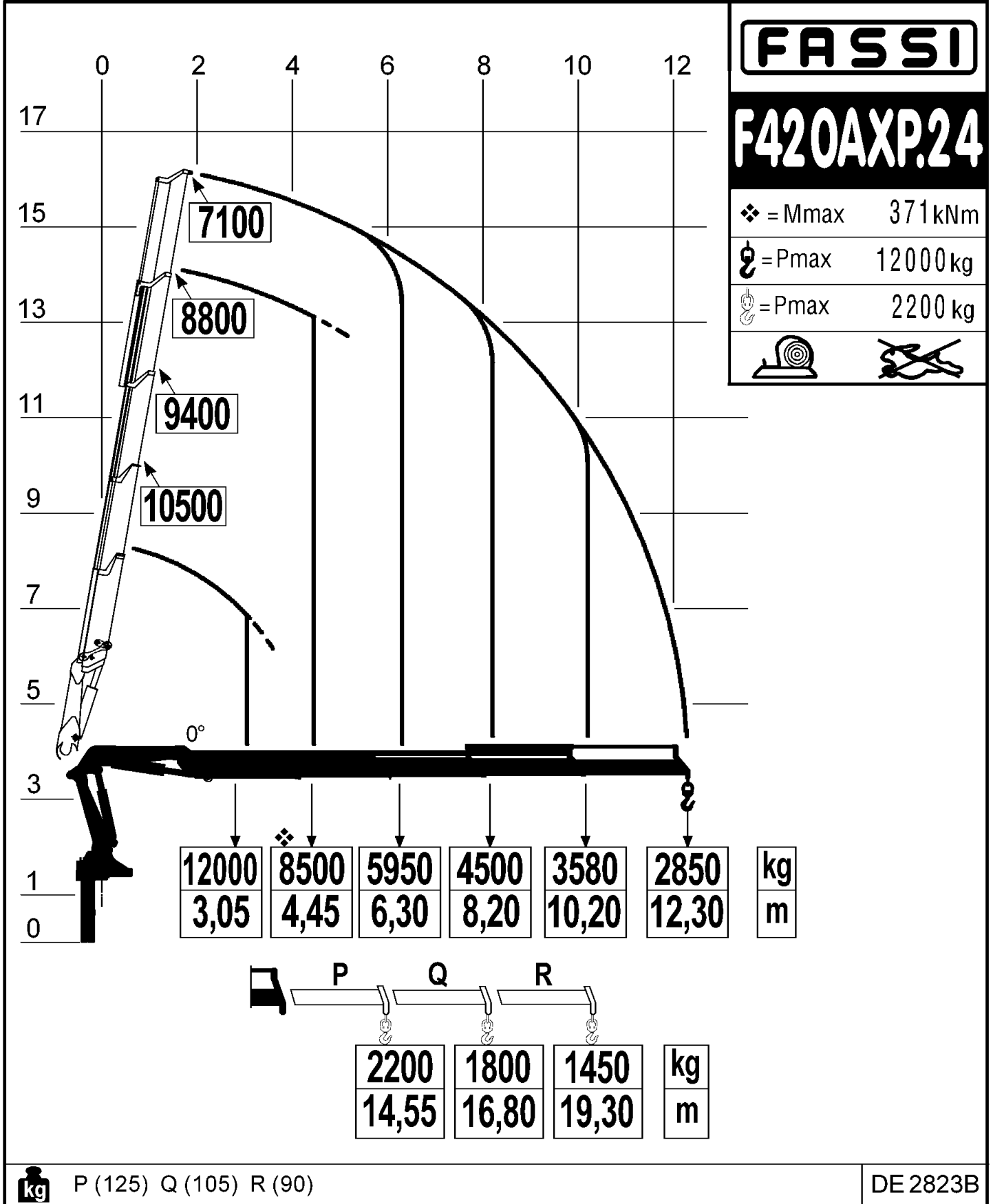

## FASSI

# F420AXP.24

$\diamond$ = Mmax	371 kNm
$\text{hook}$ = Pmax	12000 kg
$\text{hook}$ = Pmax	2200 kg

Via dei Carmelitani, 2  
24021 Albino BG  
tel. ++39 35 776400  
fax ++39 35 755020  
www.fassigroup.com  
fassi@fassigroup.com

LOAD DIAGRAM HYDRAULIC EXTENSIONS WITH LIFTING MOMENT LIMITING DEVICE

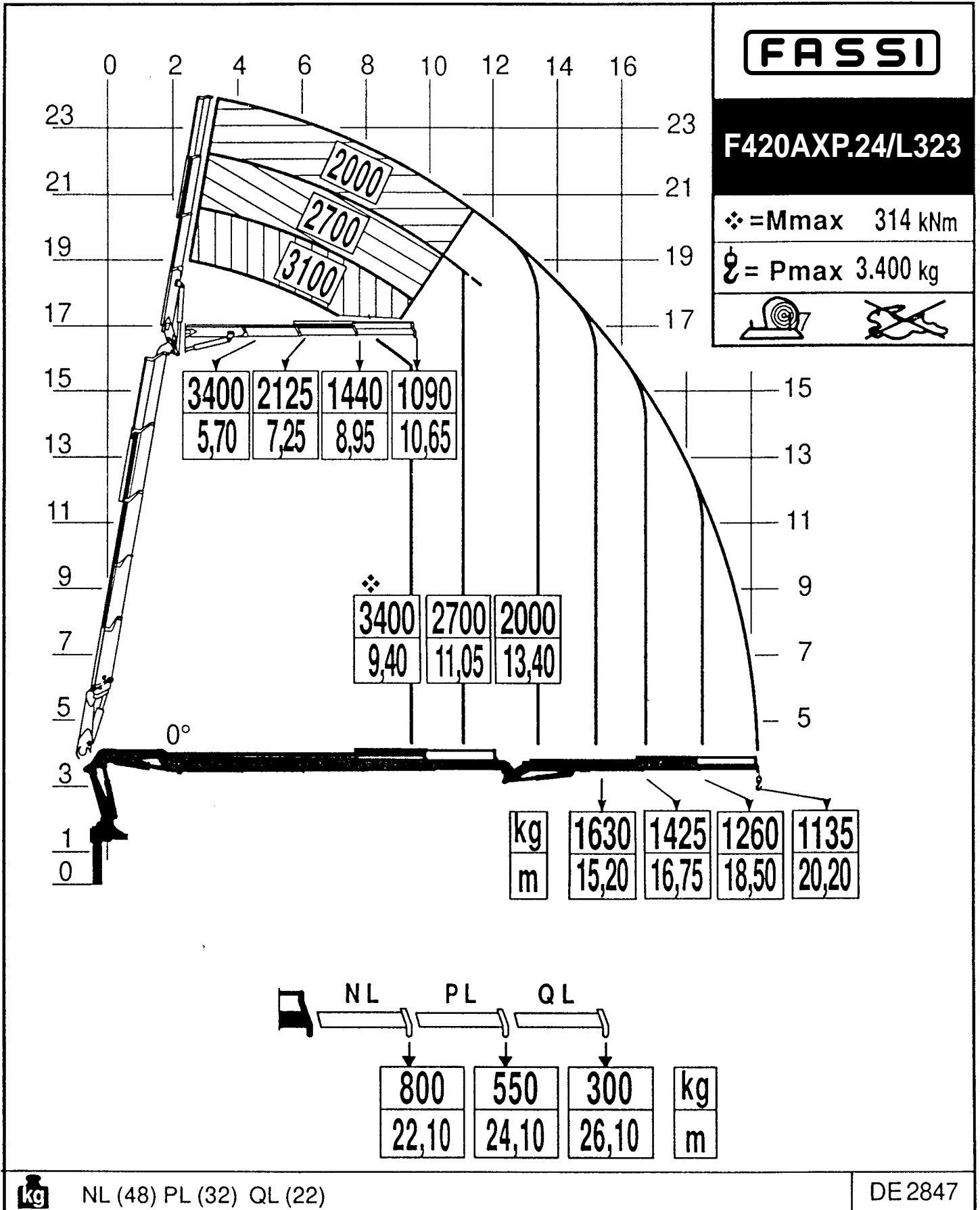

Via dei Carmelitani, 2  
24021 Albino BG  
tel. ++39 35 776400  
fax ++39 35 755020  
www.fassigroup.com  
fassi@fassigroup.com

LOAD DIAGRAM HYDRAULIC EXTENSIONS WITH LIFTING MOMENT LIMITING DEVICE

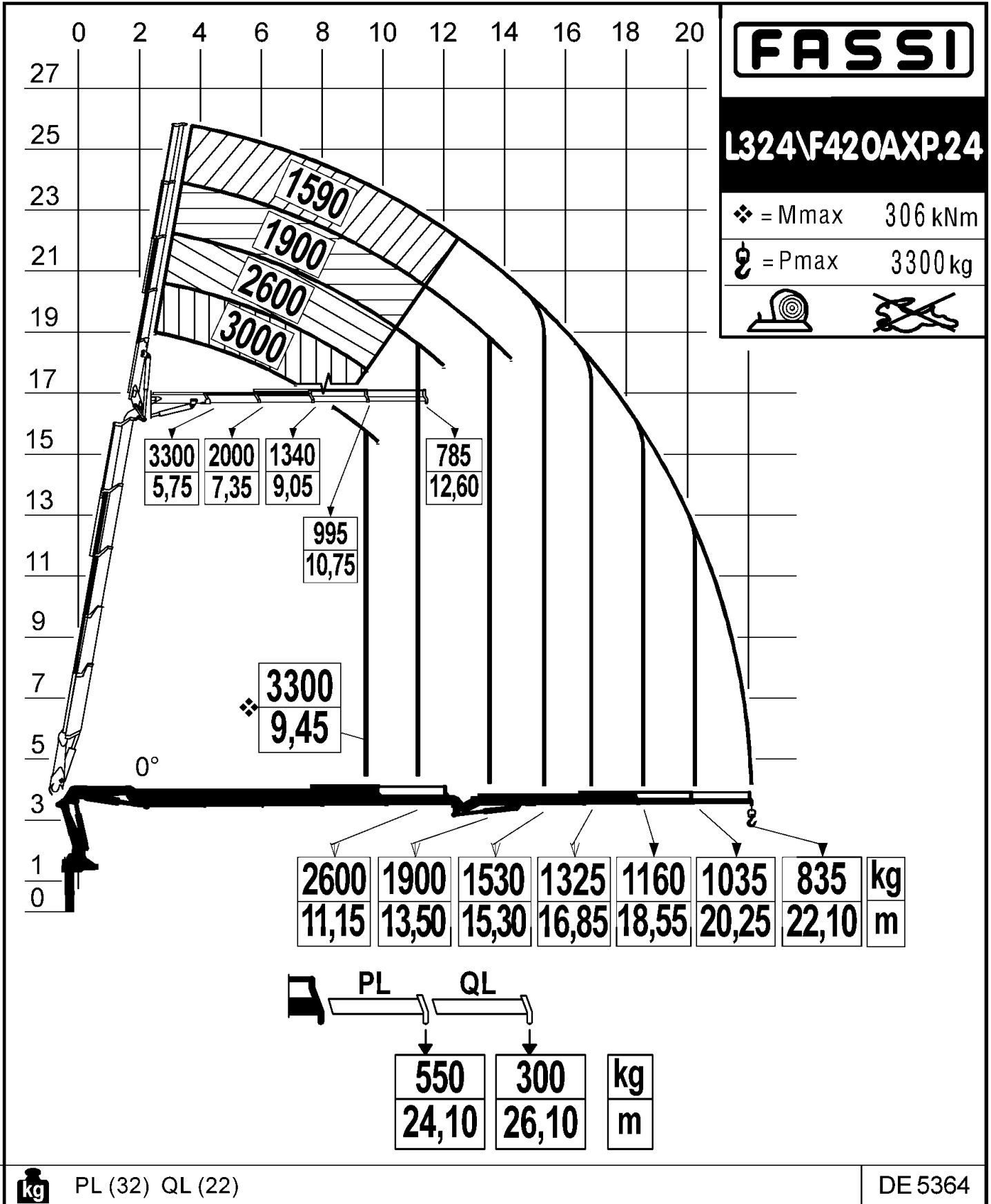

Via dei Carmelitani, 2  
24021 Albino BG  
tel. ++39 35 776400  
fax ++39 35 755020  
www.fassigroup.com  
fassi@fassigroup.com

LOAD DIAGRAM WITH LIFTING MOMENT LIMITING DEVICE

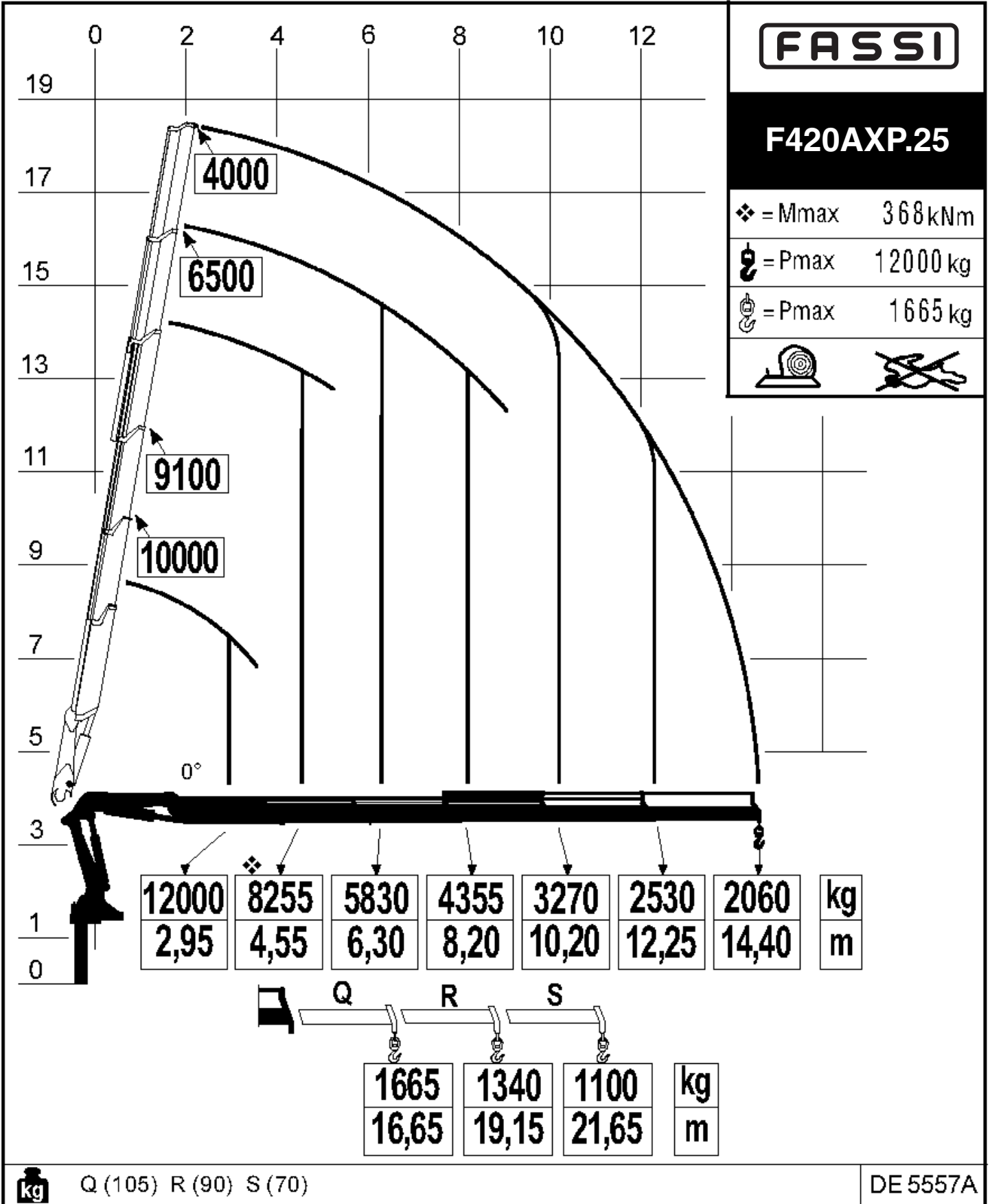

Via dei Carmelitani, 2  
24021 Albino BG  
tel. ++39 35 776400  
fax ++39 35 755020  
www.fassigroup.com  
fassi@fassigroup.com

LOAD DIAGRAM HYDRAULIC EXTENSIONS WITH LIFTING MOMENT LIMITING DEVICE

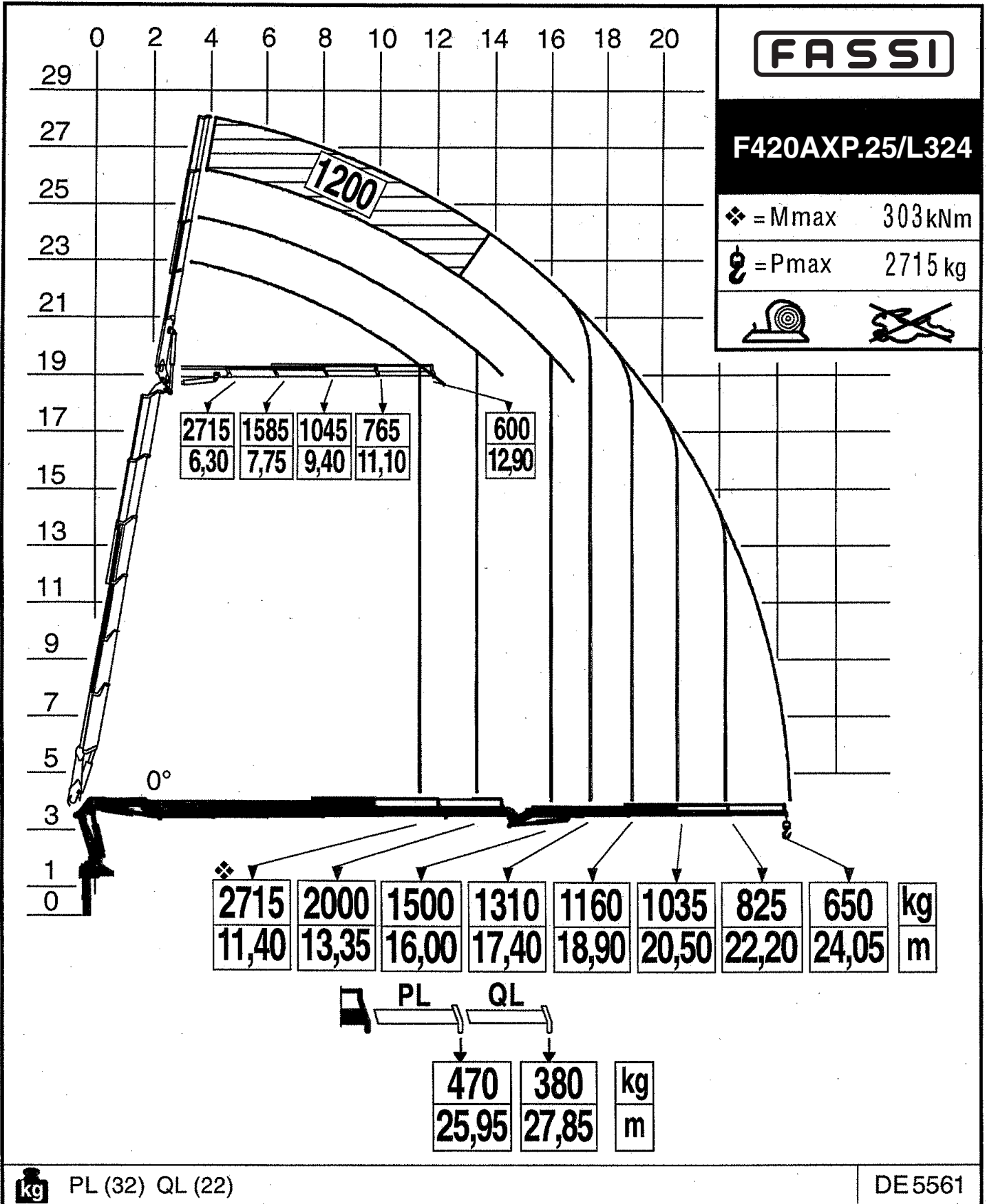

Via dei Carmelitani, 2  
24021 Albino BG  
tel. ++39 35 776400  
fax ++39 35 755020  
www.fassigroup.com  
fassi@fassigroup.com

LOAD DIAGRAM WITH LIFTING MOMENT LIMITING DEVICE

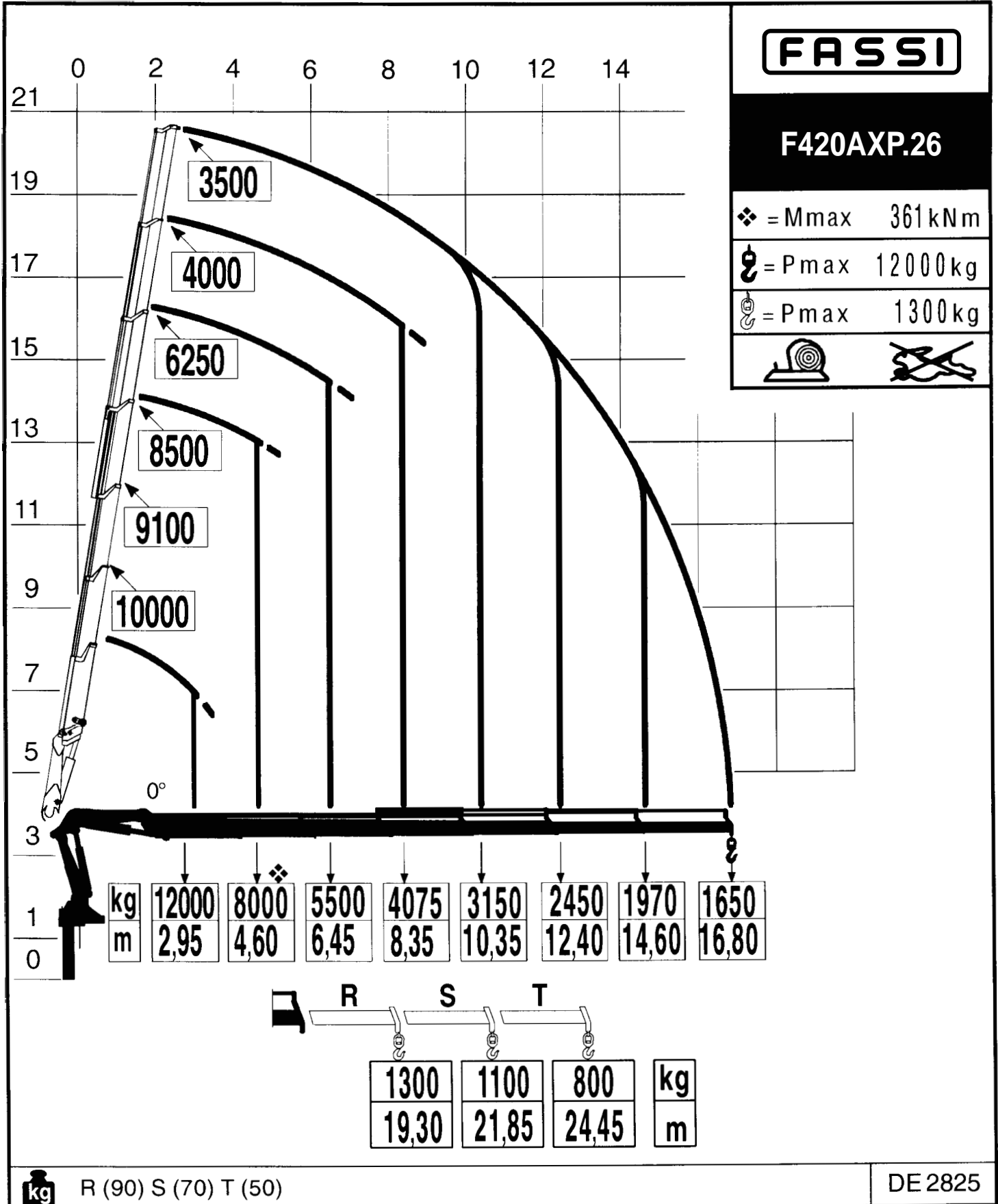

## FASSI

### F420AXP.26

❖ = Mmax 361 kNm

⚙ = Pmax 12000 kg

🔗 = Pmax 1300 kg





Via dei Carmelitani, 2  
24021 Albino BG  
tel. ++39 35 776400  
fax ++39 35 755020  
www.fassigroup.com  
fassi@fassigroup.com

LOAD DIAGRAM HYDRAULIC EXTENSIONS WITH LIFTING MOMENT LIMITING DEVICE

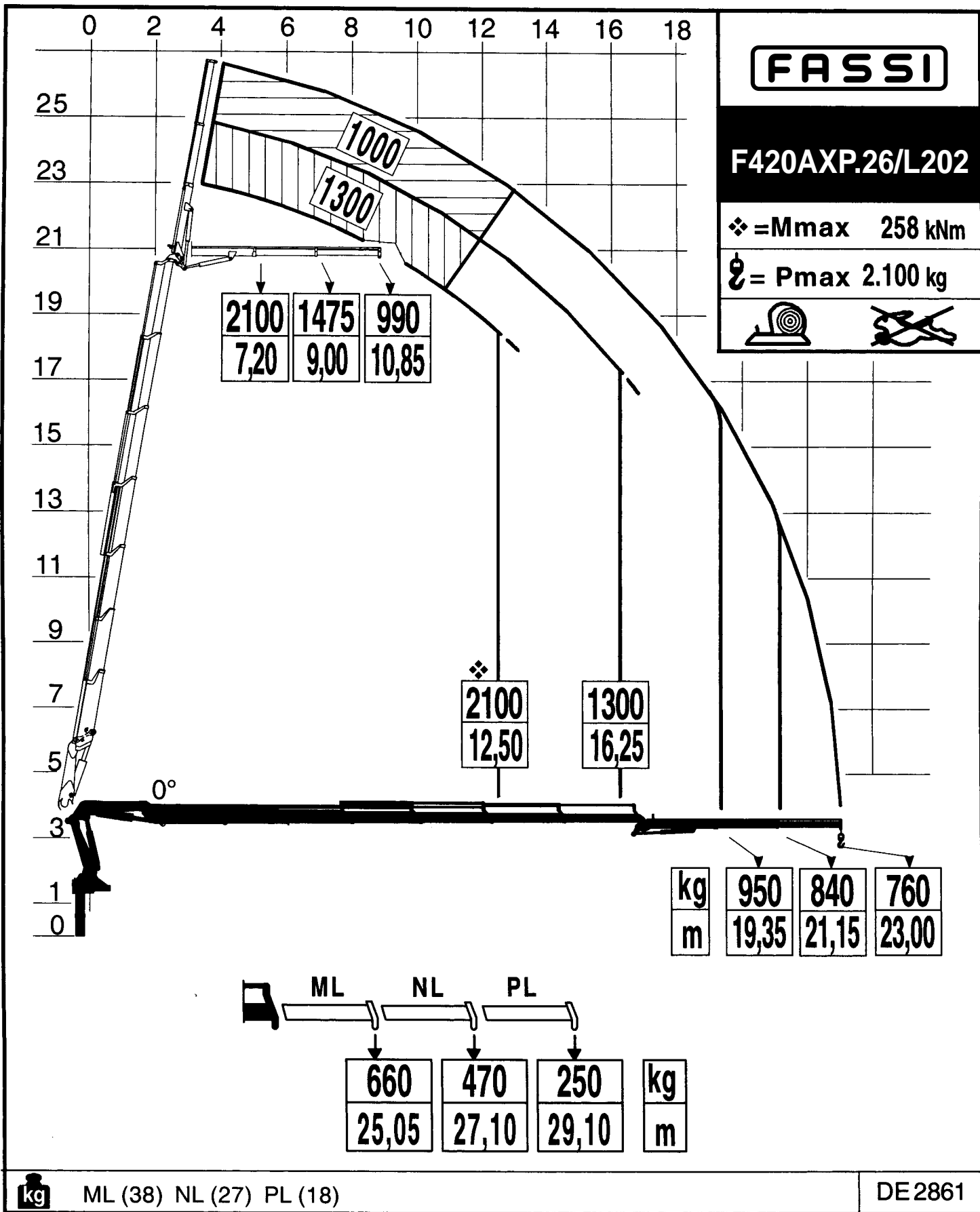

Via dei Carmelitani, 2  
24021 Albino BG  
tel. ++39 35 776400  
fax ++39 35 755020  
www.fassigroup.com  
fassi@fassigroup.com

LOAD DIAGRAM HYDRAULIC EXTENSIONS WITH LIFTING MOMENT LIMITING DEVICE

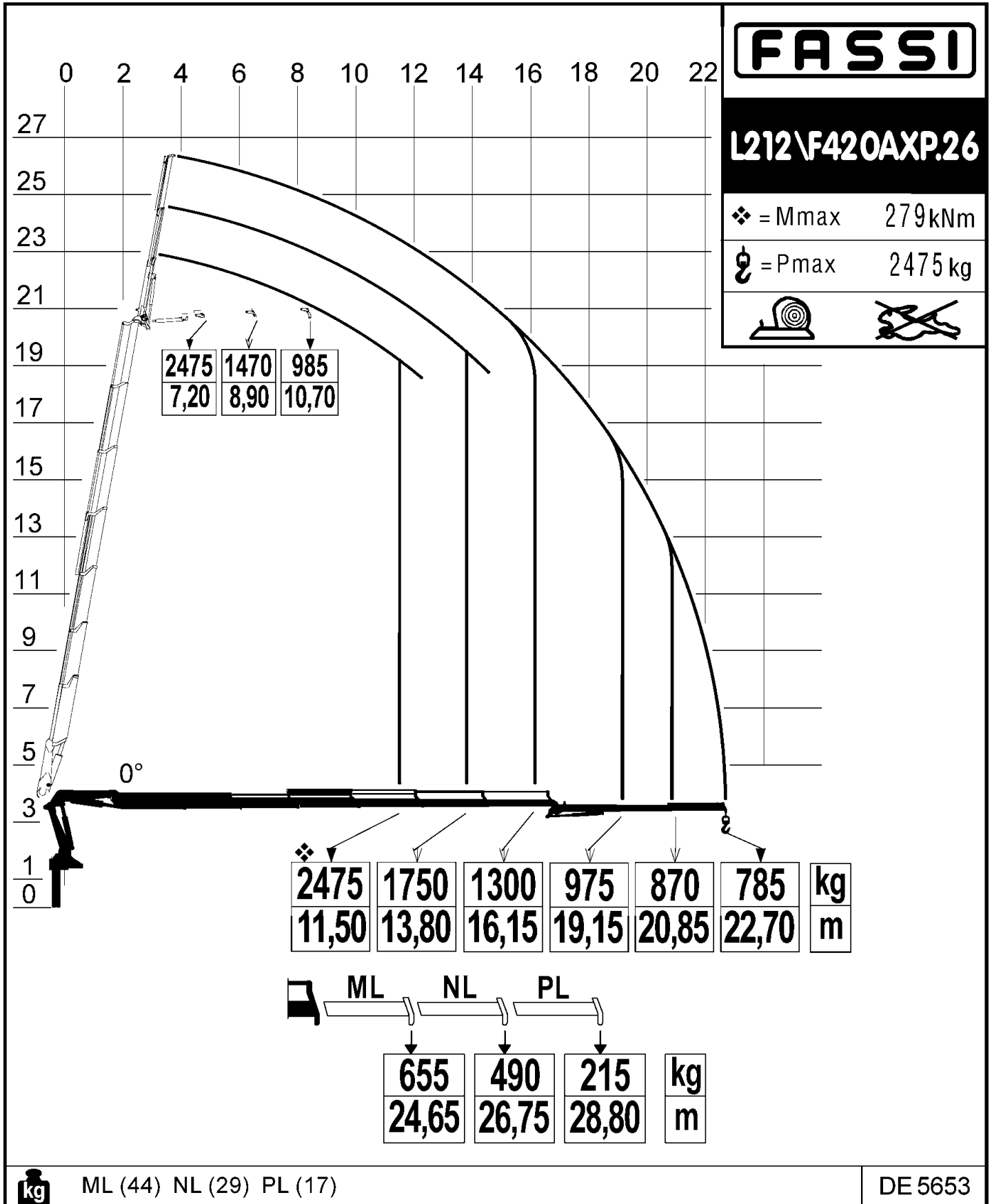

Via dei Carmelitani, 2  
24021 Albino BG  
tel. ++39 35 776400  
fax ++39 35 755020  
www.fassigroup.com  
fassi@fassigroup.com

LOAD DIAGRAM HYDRAULIC EXTENSIONS WITH LIFTING MOMENT LIMITING DEVICE

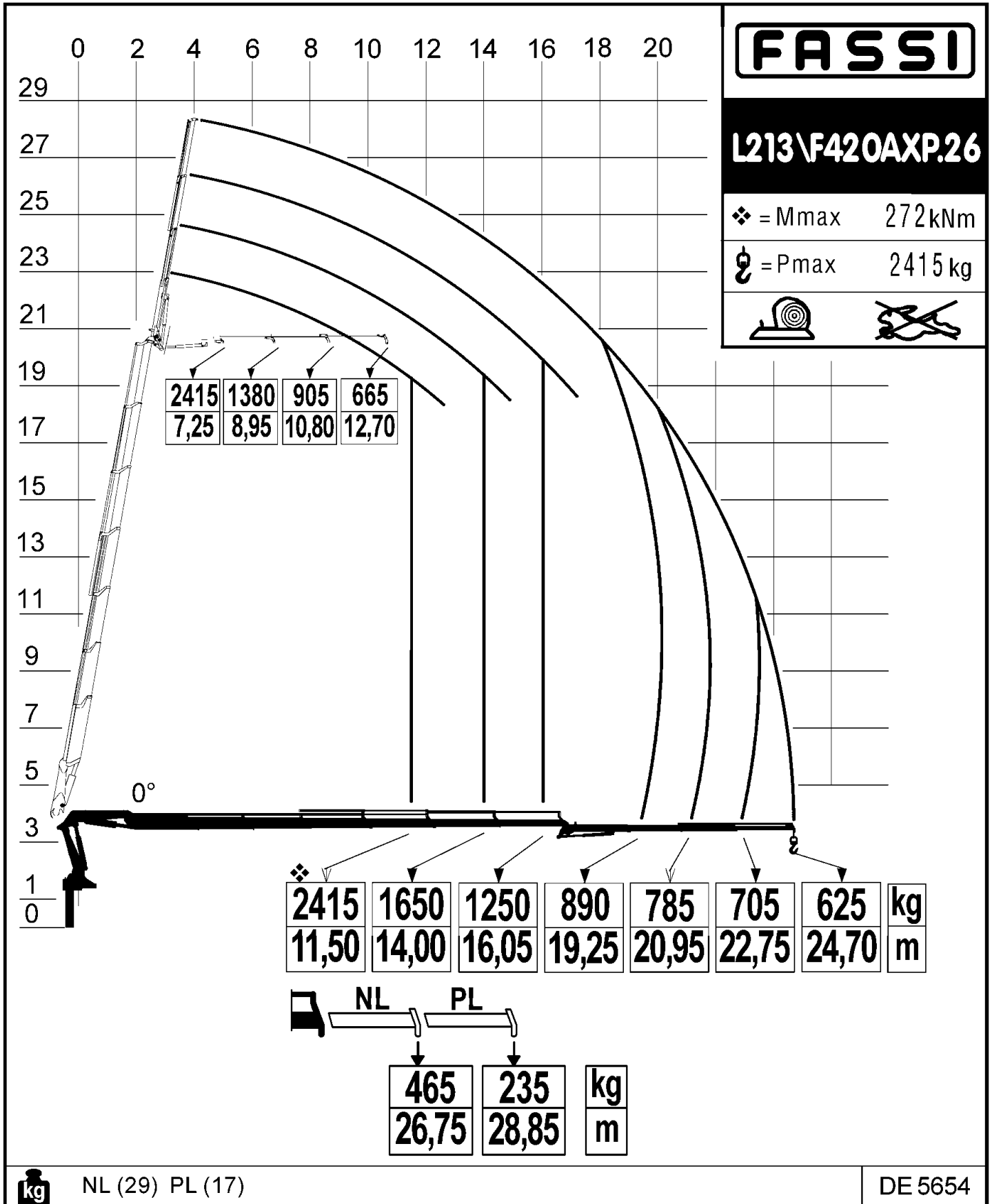

Via dei Carmelitani, 2  
 24021 Albino BG  
 tel. ++39 35 776400  
 fax ++39 35 755020  
 www.fassigroup.com  
 fassi@fassigroup.com

LOAD DIAGRAM HYDRAULIC EXTENSIONS WITH LIFTING MOMENT LIMITING DEVICE

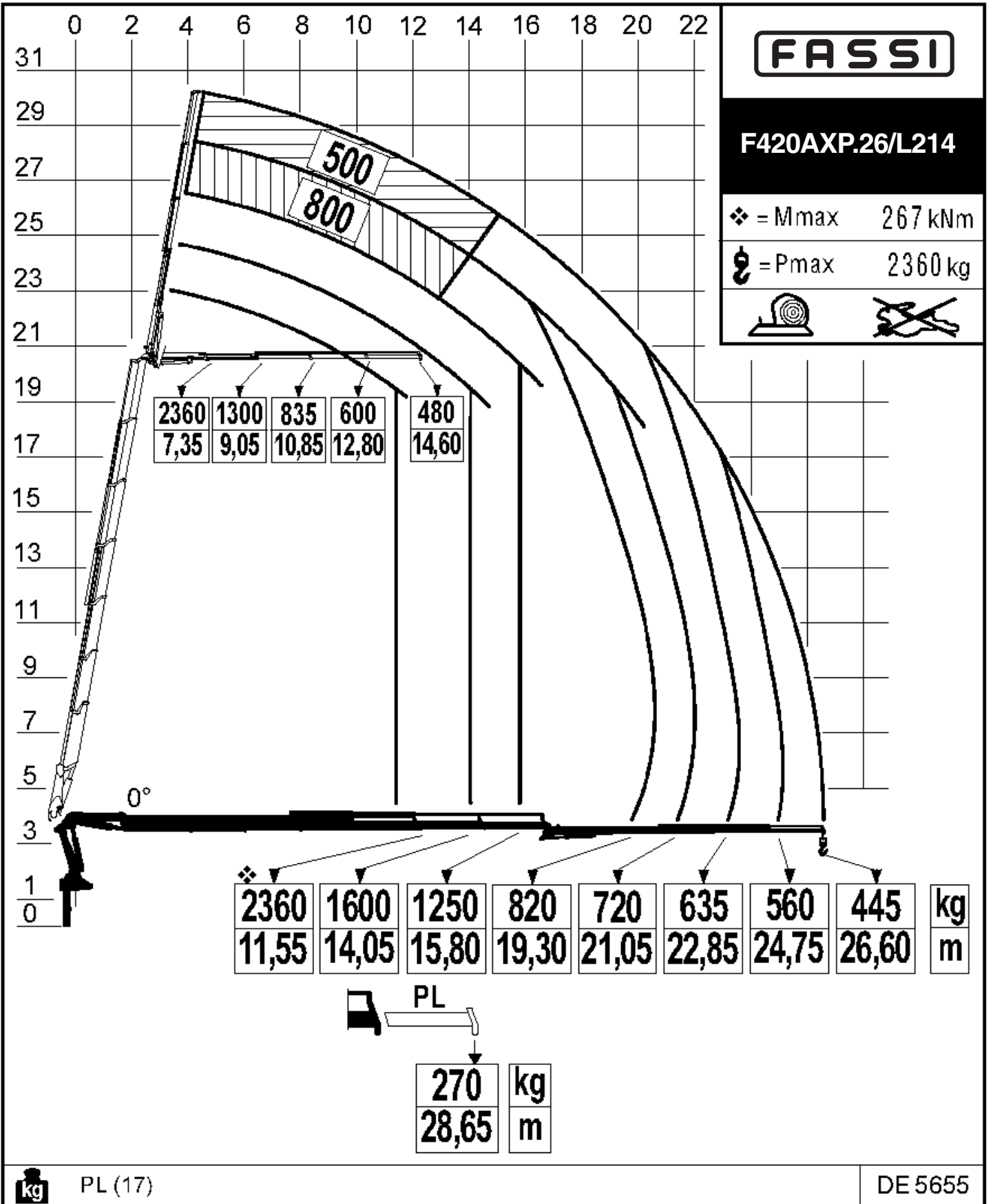

Via dei Carmelitani, 2  
24021 Albino BG  
tel. ++39 35 776400  
fax ++39 35 755020  
www.fassigroup.com  
fassi@fassigroup.com

LOAD DIAGRAM WITH LIFTING MOMENT LIMITING DEVICE

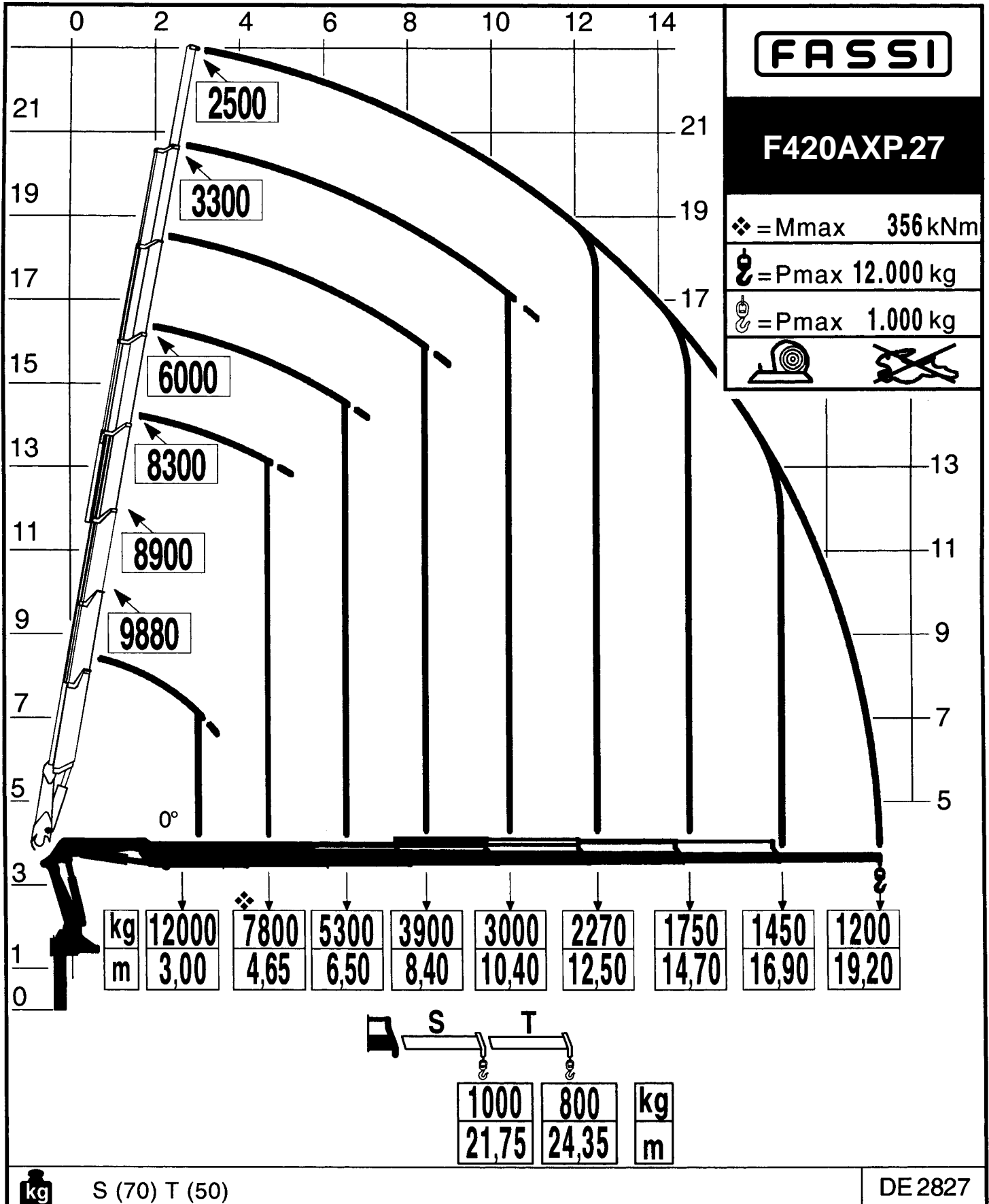

FASSI

F420AXP.27

❖ = Mmax 356 kNm

⚙ = Pmax 12.000 kg

⚙ = Pmax 1.000 kg



Via Roma, 110  
24021 Albino BG  
tel. ++39 35 776400  
fax ++39 35 755020  
www.fassigroup.com  
fassi@fassigroup.com

LOAD DIAGRAM WITH LIFTING MOMENT LIMITING DEVICE

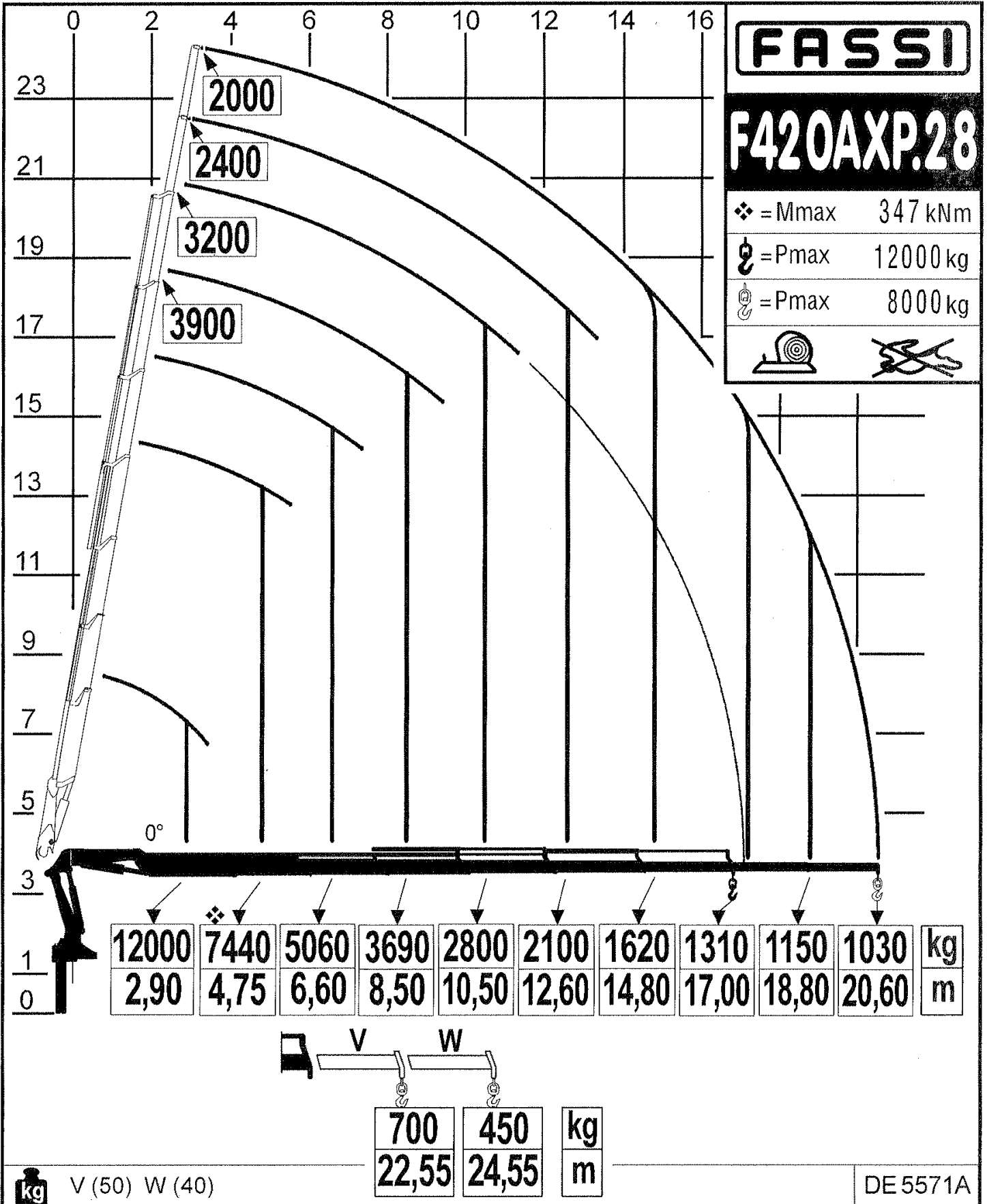

Via dei Carmelitani, 2  
24021 Albino BG  
tel. ++39 35 776400  
fax ++39 35 755020  
www.fassigroup.com  
fassi@fassigroup.com

LOAD DIAGRAM WITH LIFTING MOMENT LIMITING DEVICE

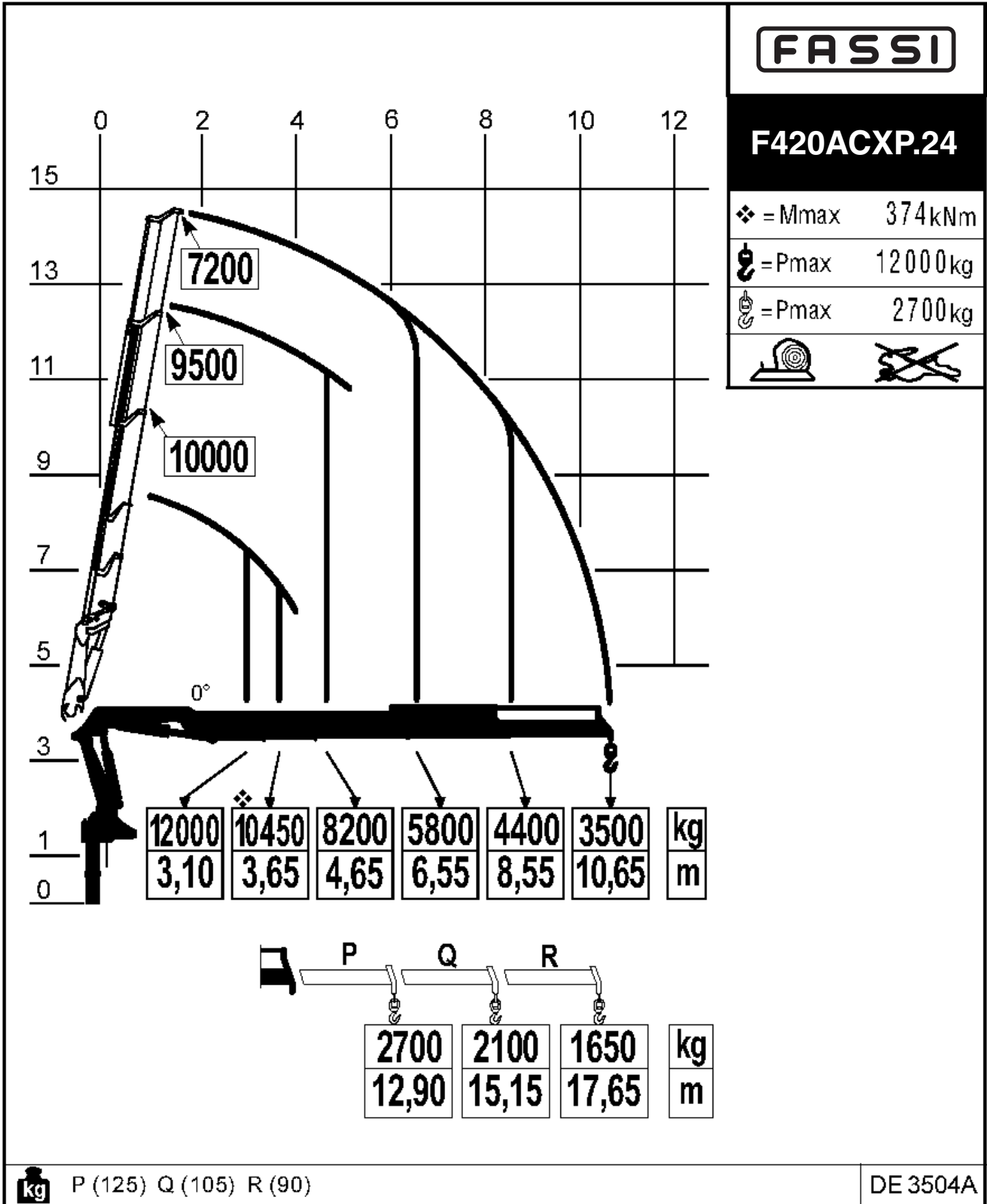

## FASSI

### F420ACXP.24

❖ = Mmax 374 kNm

⚙ = Pmax 12000 kg

⚙ = Pmax 2700 kg



Via dei Carmelitani, 2  
24021 Albino BG  
tel. ++39 35 776400  
fax ++39 35 755020  
www.fassigroup.com  
fassi@fassigroup.com

LOAD DIAGRAM HYDRAULIC EXTENSIONS WITH LIFTING MOMENT LIMITING DEVICE

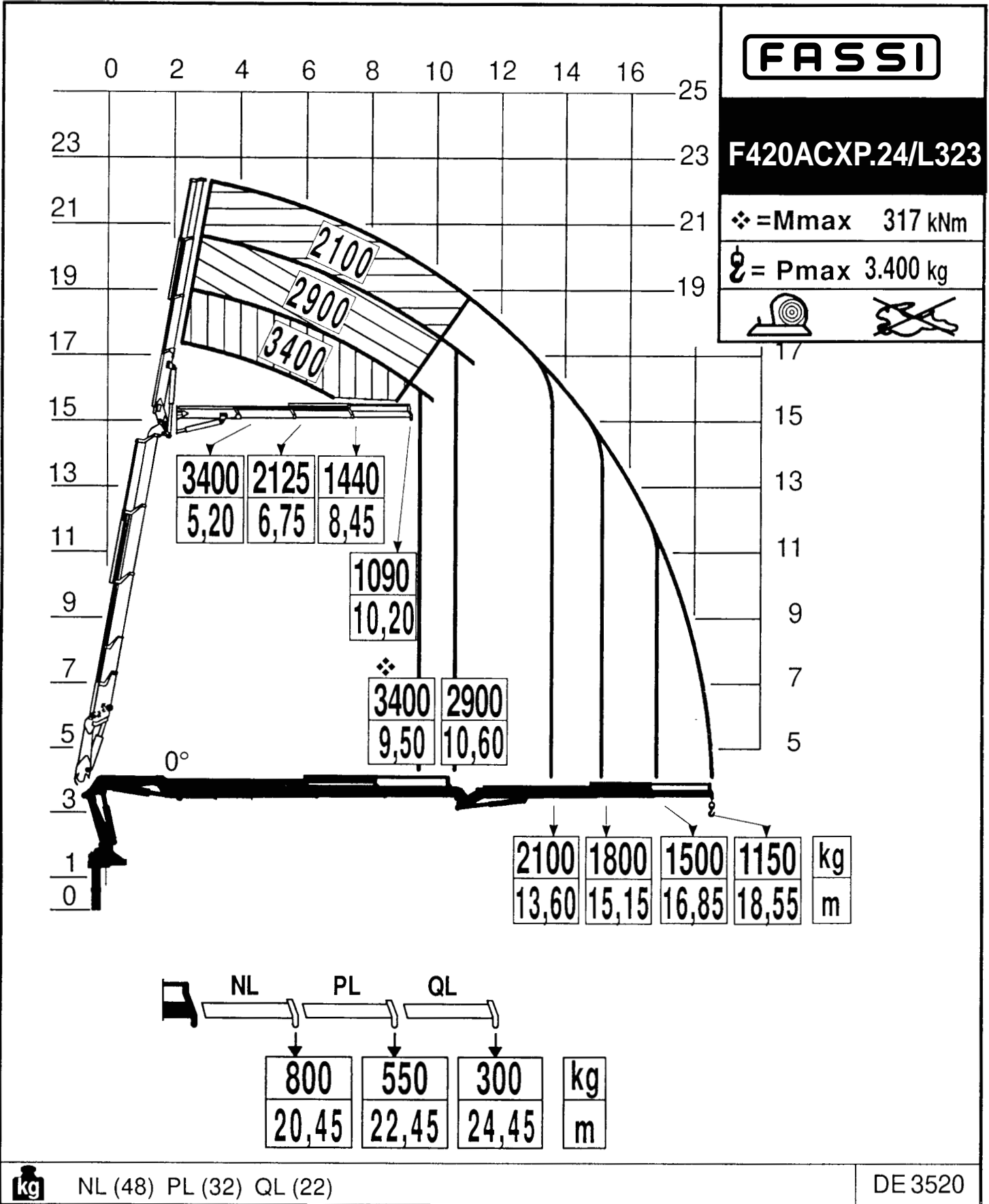



Via dei Carmelitani, 2  
24021 Albino BG  
tel. ++39 35 776400  
fax ++39 35 755020  
www.fassigroup.com  
fassi@fassigroup.com

LOAD DIAGRAM HYDRAULIC EXTENSIONS WITH LIFTING MOMENT LIMITING DEVICE

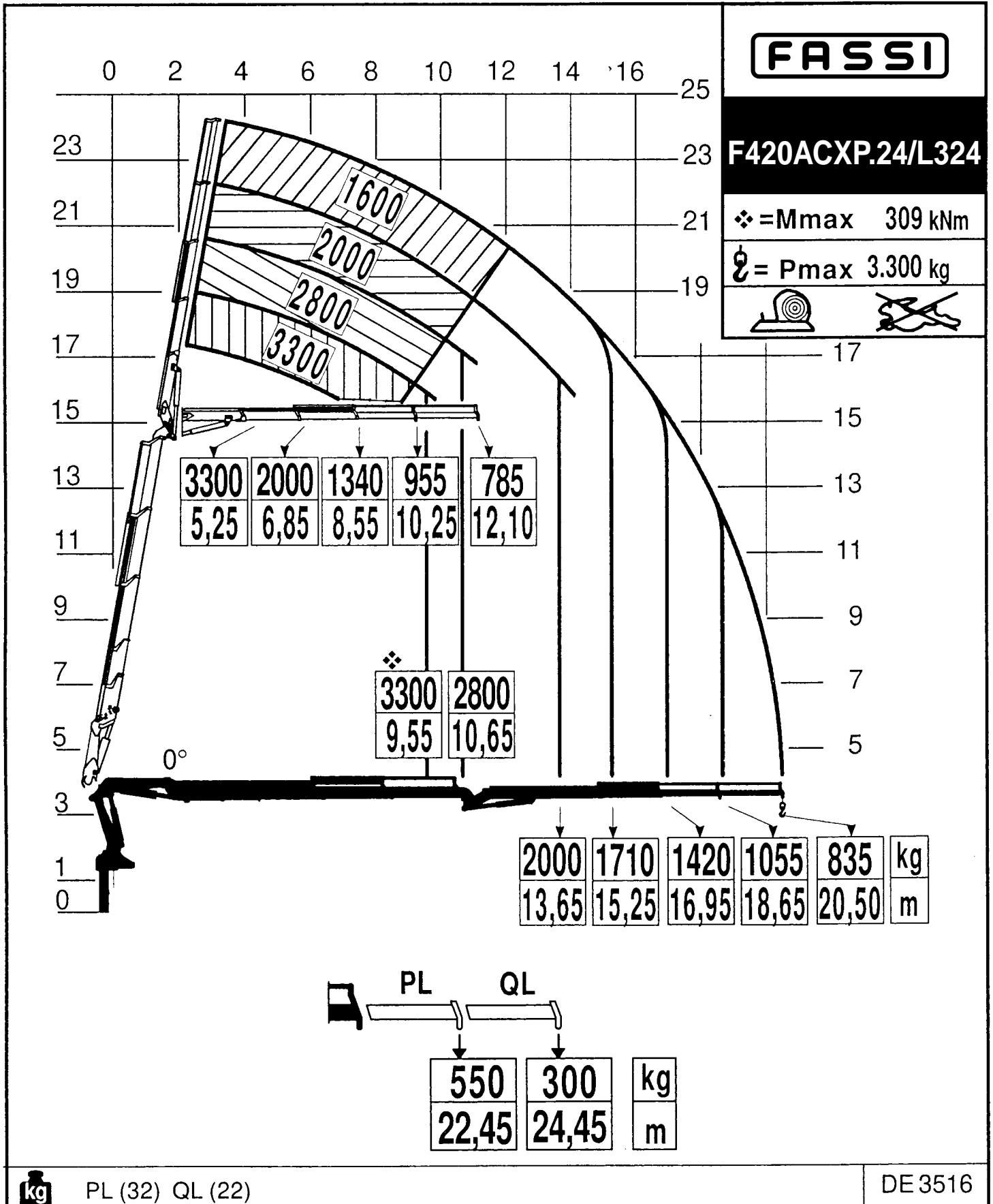

Via dei Carmelitani, 2  
24021 Albino BG  
tel. ++39 35 776400  
fax ++39 35 755020  
www.fassigroup.com  
fassi@fassigroup.com

LOAD DIAGRAM WITH LIFTING MOMENT LIMITING DEVICE

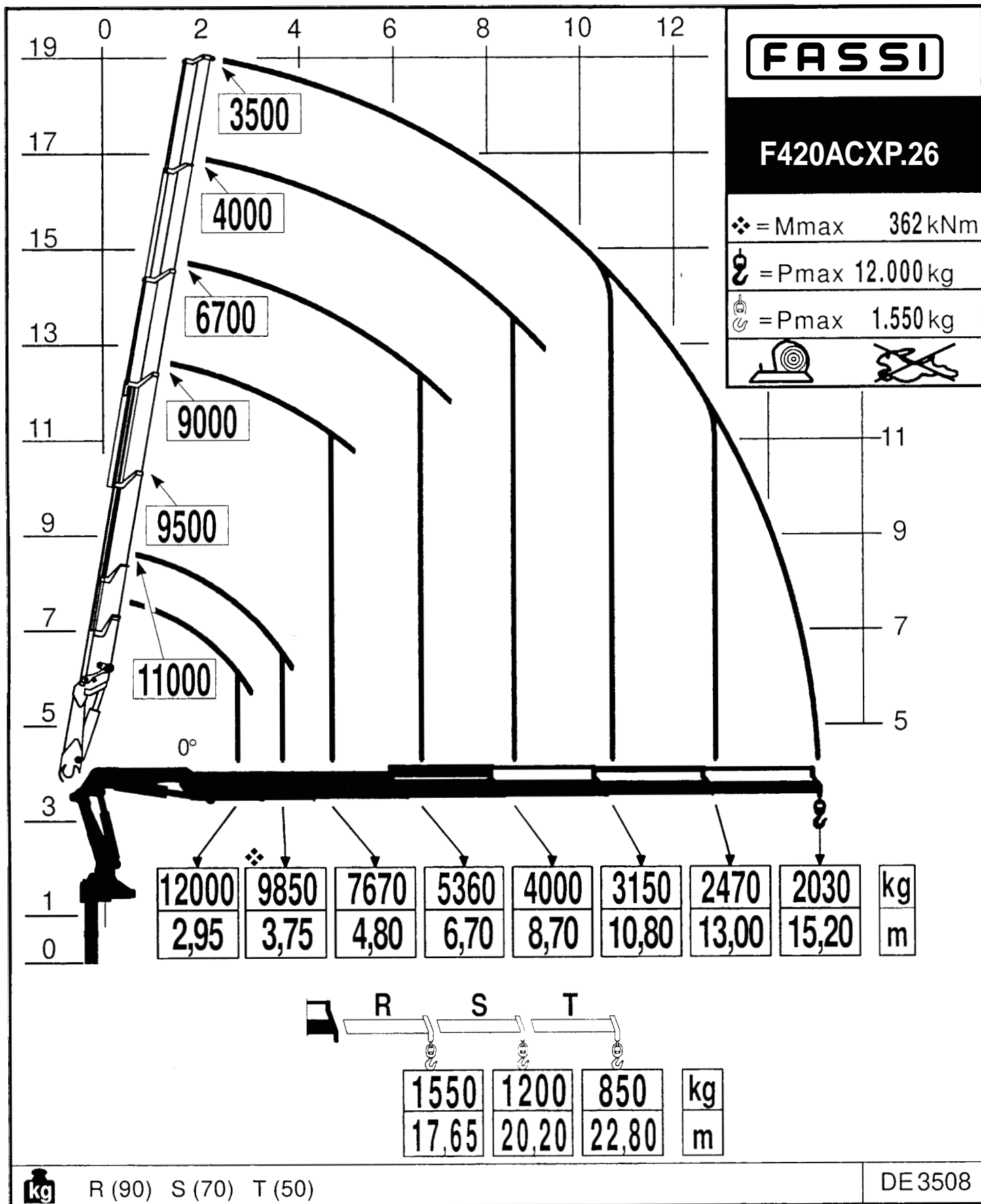

**FASSI**

**F420ACXP.26**

❖ = Mmax 362 kNm

⚙ = Pmax 12.000 kg

⚙ = Pmax 1.550 kg

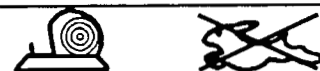

R (90) S (70) T (50)

DE 3508