



TEREX®

**ROUGH TERRAIN CRANE
RT 100**

DATASHEET - IMPERIAL







RT 100

Features:

- ▶ Rated capacity:
100 ton @ 10 ft working radius
- ▶ Maximum boom length:
174 ft
- ▶ Maximum tip height:
183 ft
- ▶ Maximum hook height:
174.5 ft

WORKS FOR YOU.™

	Page:
Key	
.....	3
Dimensions	
Crane dimensions	4
Crane weights	5
Steering radii	6
Load Charts	
Range Diagram – Main Boom – mode 1	8
Load Chart – Main Boom – mode 1	9
Range Diagram – Main Boom – mode 2	10
Load Chart – Main Boom – mode 2	11
Range Diagram – 27 ft offsettable jib	12
Load Chart – 27 ft offsettable jib	13
Range Diagram – 50 ft offsettable jib	14
Load Chart – 50 ft offsettable jib	15
Range Diagram – Pick & Carry – mode 1	16
Load Chart – Pick & Carry – mode 1	17
Technical Description	
Boom	18
Hoist, rope and hook	18, 19
Superstructure	19
Cab, controls, operator aids and load limiter / load indicator	19, 20
Carrier, engine, drive-line and hydraulic system	20
Vehicle performance	21
Tires	21

	Counterweight		General performance
	Main boom		Telescoping mode
	Boom length		Boom luffing angle
	Tip height		Working radius
	Boom with extension		Max. boom length with extension
	Main boom with aux head		Distance from the hook to the head sheave pin
	Slewing / Allowable slewing range		Slewing locked / Slewing locked at specified position
	Slewing brake		Slewing gears
	Outriggers / Lifting on outriggers (100/50/0% extended)		Lifting on wheels / Pick & Carry
	Main hoist		Auxiliary hoist
	Hoist speed		Rope length
	Rope – Standard / Optional		Max. line pull
	Rope diameter		Tire
	Hook block		Controls
	Cab		Engine
	Operator aids / Load limiter / Load indicator		Steering
	Mechanical transmission		Speed
	Hydraulics		Heating / Air conditioning
	Working temperature		Gradeability
	Lights		Gross vehicle weight
	Crane / Crane in standard configuration		Weight on front axle
	Crane without counterweight		Weight on rear axle

CRANE DIMENSIONS



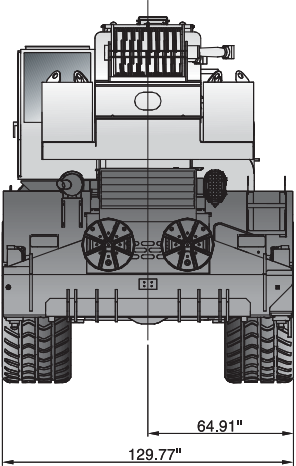
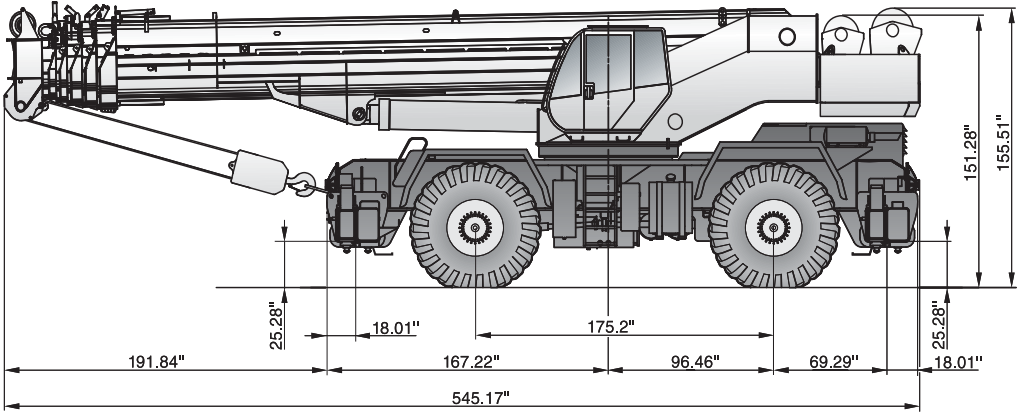
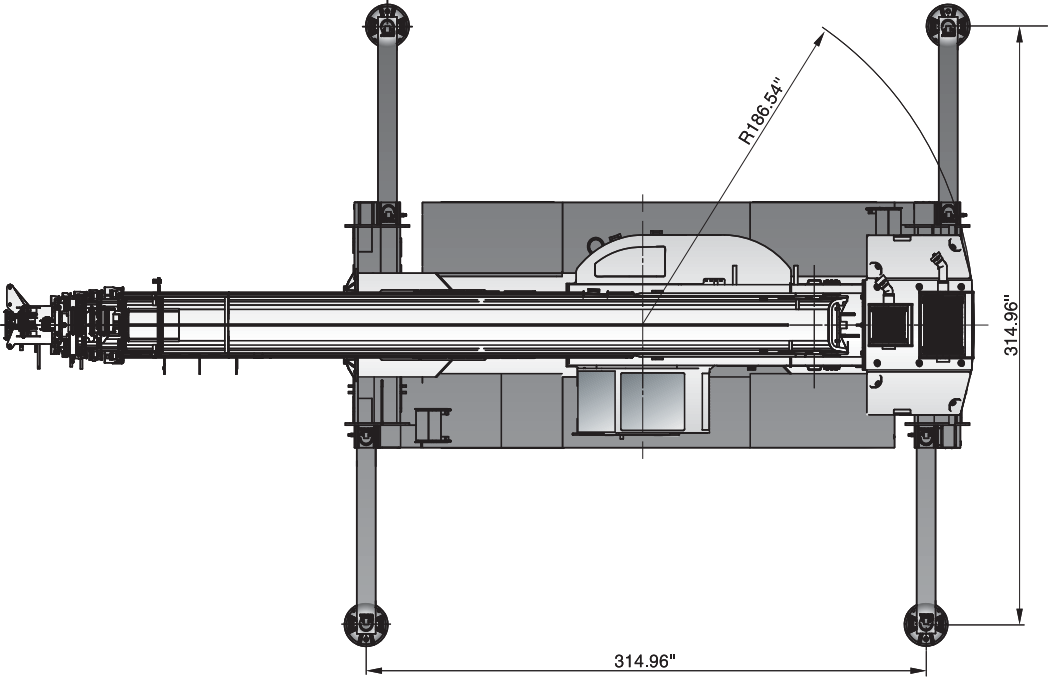

RT 100

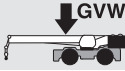
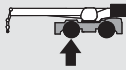
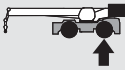
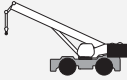

CRANE WEIGHTS

RT 100

Approximate Weights

				
		125,663 lb	59,755 lb	65,908 lb
Add / Subtract for main optional equipment				
	25 ft stowed aside the boom	+ 1422 lb	+ 2119 lb	- 696 lb
	47 ft stowed aside the boom	+ 1797 lb	+ 2679 lb	- 882 lb
	Auxiliary hoist TW4**	+ 1125 lb	- 269 lb	+ 1394 lb

NOTE: Values are subject to 2% variation

* Weight distribution calculated considering the hook block linked to the front shield of the machine

** Weight includes rope

STEERING RADII

RT 100

Two wheel steer

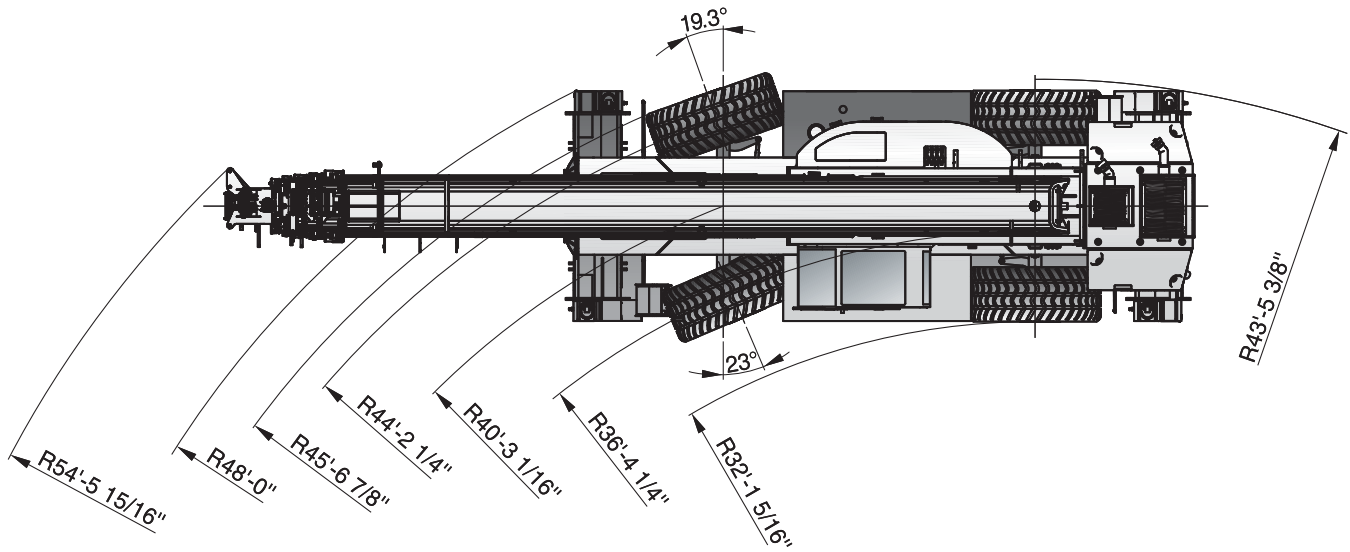

STEERING RADII

RT 100

Four wheel steer

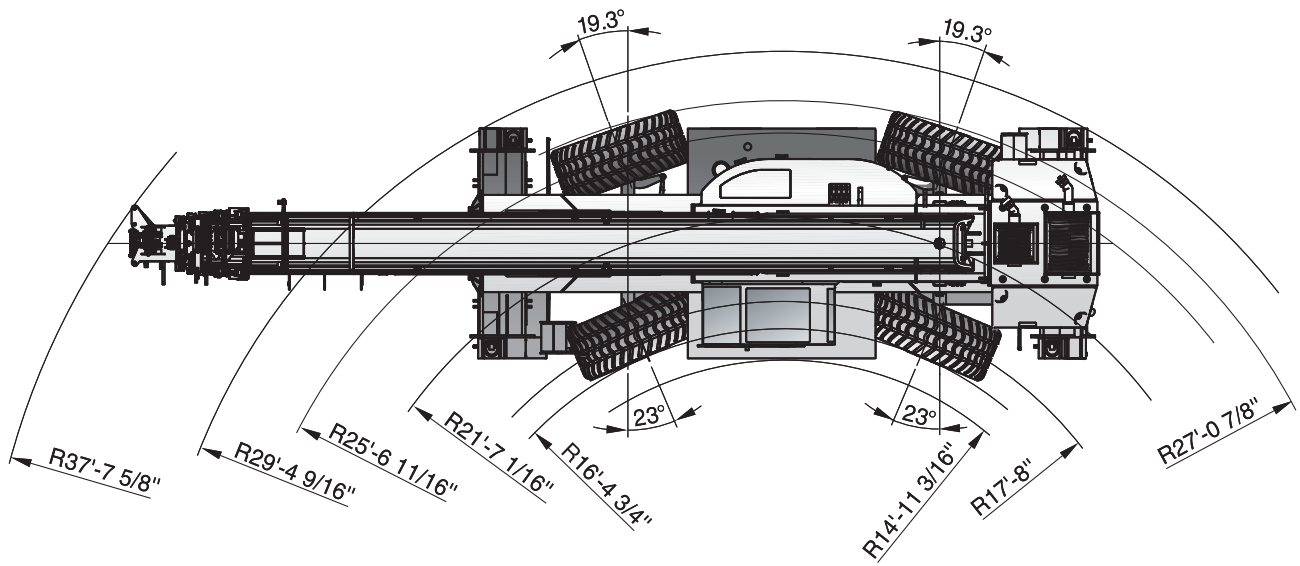

RANGE DIAGRAM - MAIN BOOM

RT 100

Mode 1

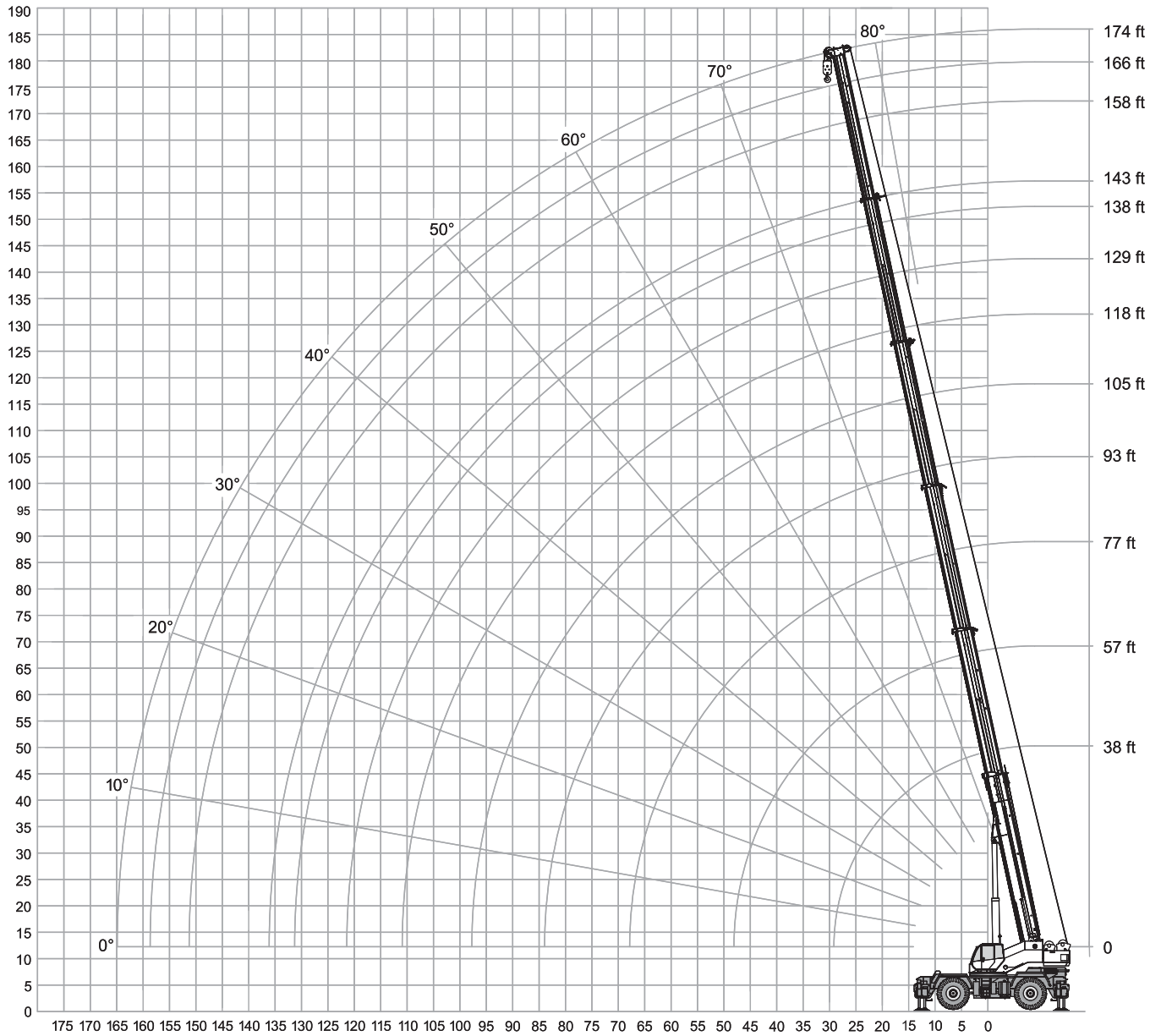
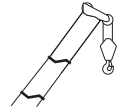
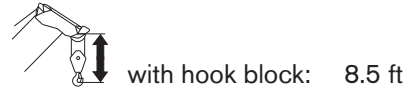

LOAD CHART – MAIN BOOM

RT 100



Mode 1

 22,000 lbs

 26 ft (100%)

 360°

Standard ASME
B30.5

	Boom Length												
	38 ft	57 ft	77 ft	93 ft	105 ft	118 ft	129 ft	138 ft	143 ft	158 ft	166 ft	174 ft	
ft	lbs	lbs	lbs	lbs	lbs	lbs	lbs	lbs	lbs	lbs	lbs	lbs	ft
10	200,000	41,500											10
12	176,200	41,000	36,400										12
15	153,000	39,900	36,900	32,400									15
20	121,250	37,900	37,300	31,800	30,500	28,200							20
25	90,400	35,800	36,800	30,600	29,900	28,000	26,600						25
30		33,800	36,200	28,400	29,000	27,600	26,300	23,400					30
35		32,100	33,400	24,700	27,700	27,200	26,100	23,400	24,500		17,000		35
40		30,300	30,100	21,700	24,900	26,400	25,500	23,100	24,300	20,500	16,900	14,200	40
45		28,900	27,500	19,200	22,300	24,300	23,100	22,700	21,800	19,500	16,800	13,200	45
50			25,300	17,200	20,000	22,100	20,900	20,800	19,700	17,800	16,200	12,100	50
55			23,500	15,300	18,200	20,000	19,000	18,800	17,900	16,200	15,100	11,300	55
60			21,900	13,800	16,500	18,200	17,400	17,200	16,200	14,800	13,900	10,500	60
65			20,100	12,500	15,100	16,600	15,800	15,800	14,600	13,600	12,700	9,700	65
70				11,400	13,800	15,400	14,500	14,500	13,300	12,400	11,600	9,000	70
75				10,200	12,700	14,100	13,400	13,300	12,000	11,300	10,700	8,400	75
80				9,400	11,700	13,000	12,300	12,200	11,000	10,500	9,700	7,800	80
85					10,800	12,000	11,400	11,100	10,000	9,600	9,000	7,200	85
90					10,000	11,100	10,600	10,200	9,100	8,800	8,300	6,700	90
95					9,300	10,300	9,800	9,400	8,300	8,000	7,600	6,200	95
100						9,600	9,000	8,400	7,600	7,300	7,000	5,700	100
105						8,600	8,000	7,400	6,800	6,600	6,300	5,300	105
110							7,000	6,500	6,200	5,900	5,700	4,600	110
115							6,200	5,700	5,500	5,400	5,100	4,100	115
120								5,000	4,700	4,800	4,500	3,600	120
125								4,300	4,000	4,300	4,100	3,100	125
130										3,800	3,700	2,700	130
135										3,400	3,200	2,200	135
140										3,000	2,800	1,800	140
145										2,500	2,400	1,400	145
150											2,000	1,100	150
155												700	155
160												500	160

Notes to lifting capacity

Lifting capacities do not exceed 85% of tipping load. Weight of hook blocks and slings is part of the load, and is to be deducted from the capacity ratings. Consult operation manual for further details.

Note: Data published herein is intended as a guide only and shall not be construed to warrant applicability for lifting purposes. Crane operation is subject to the computer charts and operation manual both supplied with the crane.

RANGE DIAGRAM - MAIN BOOM

RT 100

Mode 2

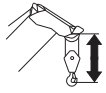
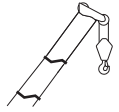

with hook block: 8.5 ft

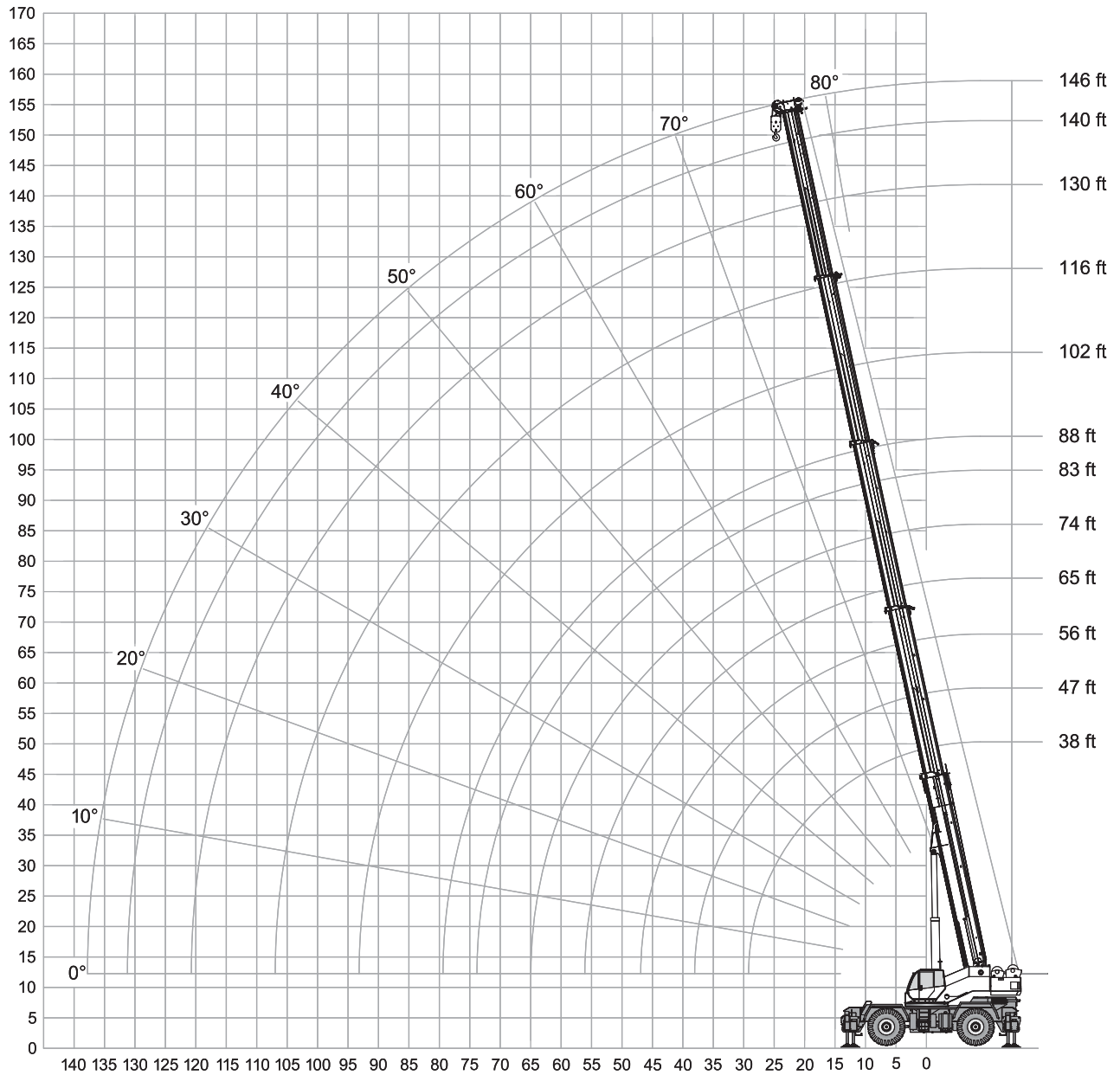

LOAD CHART – MAIN BOOM

RT 100

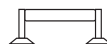

Mode 2

 22,000 lbs

 26 ft (100%)

 360°

Standard ASME
B30.5

	Boom Length													
	38 ft	47 ft	56 ft	65 ft	74 ft	83 ft	88 ft	102 ft	116 ft	130 ft	140 ft	146 ft		
ft	lbs	lbs	lbs	lbs	lbs	lbs	lbs	lbs	lbs	lbs	lbs	lbs	lbs	ft
10	200,000	162,100	124,700	120,400	100,000									10
12	176,200	148,500	113,500	110,100	91,200	87,200								12
15	153,000	130,200	99,900	96,500	80,700	76,800	70,500	63,000						15
20	121,300	108,100	83,400	80,200	67,200	64,000	58,800	52,500	48,100					20
25	90,400	90,800	71,500	68,300	57,100	54,400	49,900	44,900	41,000	36,400				25
30		72,300	62,200	59,500	49,200	46,800	42,800	38,300	35,400	32,100	28,100	25,200		30
35		58,900	55,300	52,100	43,200	41,100	37,600	33,400	30,900	28,400	24,900	22,700		35
40			45,200	44,400	38,300	36,400	32,900	29,500	26,900	25,100	22,300	20,200		40
45			36,300	35,600	34,300	32,500	29,300	26,200	24,000	22,200	20,000	18,100		45
50				29,200	28,700	28,300	26,100	23,300	21,300	19,700	17,900	16,200		50
55					23,800	23,400	23,300	20,900	19,000	17,600	16,200	14,400		55
60					19,900	19,600	19,400	18,800	17,100	15,800	14,500	12,800		60
65						16,200	16,000	17,000	15,300	14,200	12,900	11,300		65
70						13,600	13,400	14,800	13,800	12,800	11,500	10,100		70
75							11,300	12,600	12,500	11,500	10,400	8,900		75
80								10,600	11,300	10,300	9,200	7,900		80
85								9,100	10,100	9,300	8,200	7,100		85
90								7,700	8,700	8,500	7,500	6,200		90
95									7,400	7,500	6,600	5,400		95
100									6,300	6,800	5,900	4,800		100
105										6,000	5,200	4,200		105
110										5,100	4,600	3,600		110
115										4,300	4,000	3,100		115
120											3,400	2,600		120
125											3,000	2,100		125
130												1,600		130

Notes to lifting capacity

Lifting capacities do not exceed 85% of tipping load. Weight of hook blocks and slings is part of the load, and is to be deducted from the capacity ratings. Consult operation manual for further details.

Note: Data published herein is intended as a guide only and shall not be construed to warrant applicability for lifting purposes. Crane operation is subject to the computer charts and operation manual both supplied with the crane.

RANGE DIAGRAM - MAIN BOOM

RT 100

With Jib, 27 ft offset

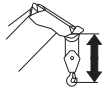
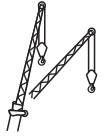

with hook block: 8.5 ft

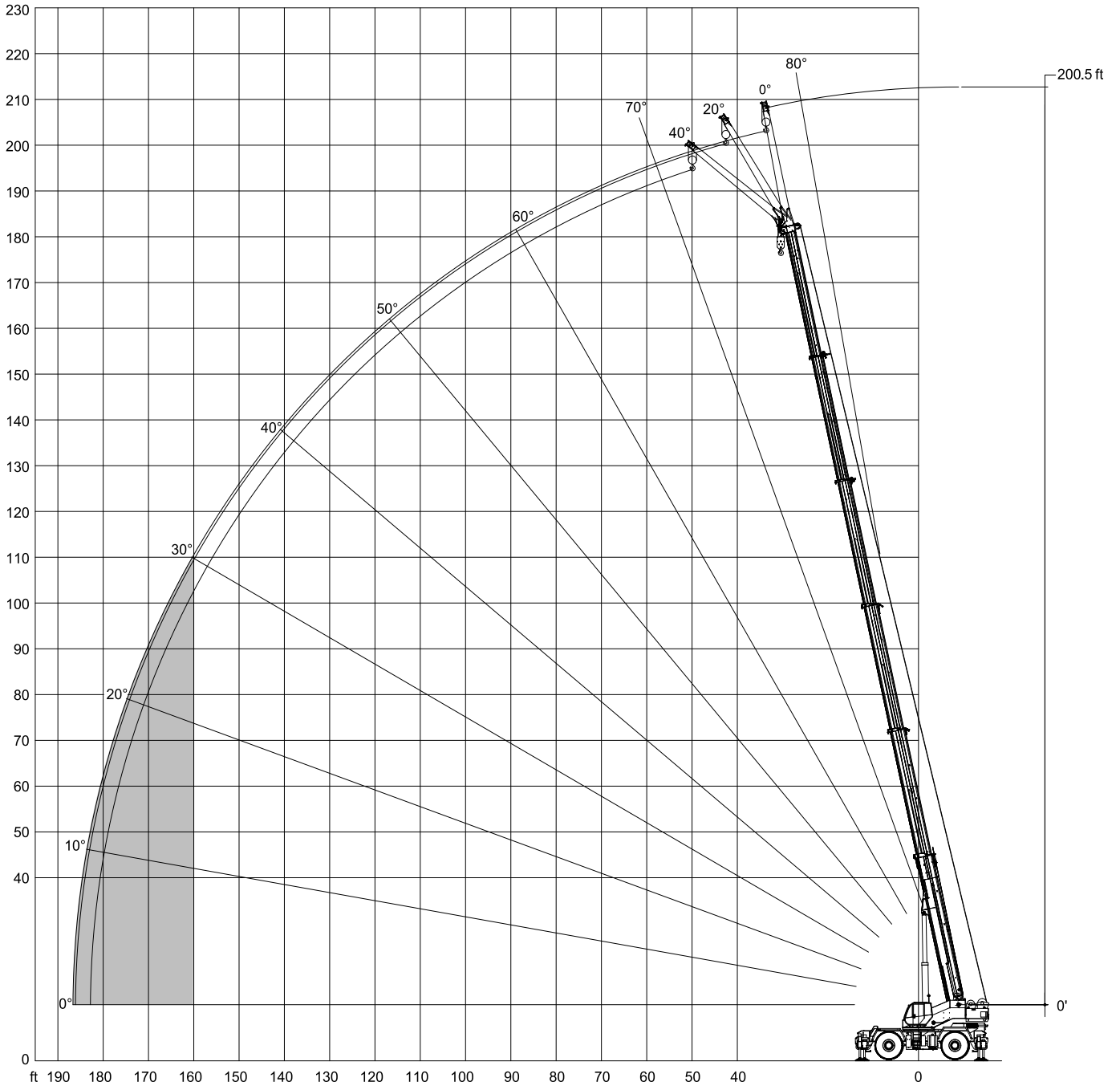

LOAD CHART – MAIN BOOM

RT 100



With Jib, 27 ft offset

 22,000 lbs

 26 ft (100%)

 360°

Standard ASME
B30.5

27 ft Offsettable Jib					
0°		20°		40°	
 ft	lbs	 ft	lbs	 ft	lbs
40	7,400	45	6,200	50	4,900
45	7,300	50	5,800	55	4,700
50	7,100	55	5,300	60	4,300
55	6,500	60	4,900	65	4,100
60	6,000	65	4,600	70	3,900
65	5,500	70	4,300	75	3,700
70	5,100	75	4,000	80	3,500
75	4,700	80	3,800	85	3,300
80	4,400	85	3,500	90	3,100
85	4,100	90	3,400	95	3,000
90	3,800	95	3,200	100	2,800
95	3,500	100	3,000	105	2,600
100	3,300	105	2,900	110	2,600
105	3,100	110	2,700	115	2,400
110	2,900	115	2,500	120	2,300
115	2,800	120	2,400	125	2,200
120	2,600	125	2,300	130	2,100
125	2,300	130	2,100	135	2,000
130	2,000	135	2,000	140	1,800
135	1,500	140	1,500	145	1,400
140	1,300	145	1,300	150	1,200
145	900	150	900	155	800
150	700	155	700	160	600
155	500	160	500		

Notes to lifting capacity

Lifting capacities do not exceed 85% of tipping load. Weight of hook blocks and slings is part of the load, and is to be deducted from the capacity ratings. Consult operation manual for further details.

Note: Data published herein is intended as a guide only and shall not be construed to warrant applicability for lifting purposes. Crane operation is subject to the computer charts and operation manual both supplied with the crane.

RANGE DIAGRAM - MAIN BOOM

RT 100

With Jib, 50 ft offset

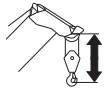
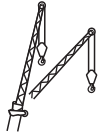

with hook block: 8.5 ft

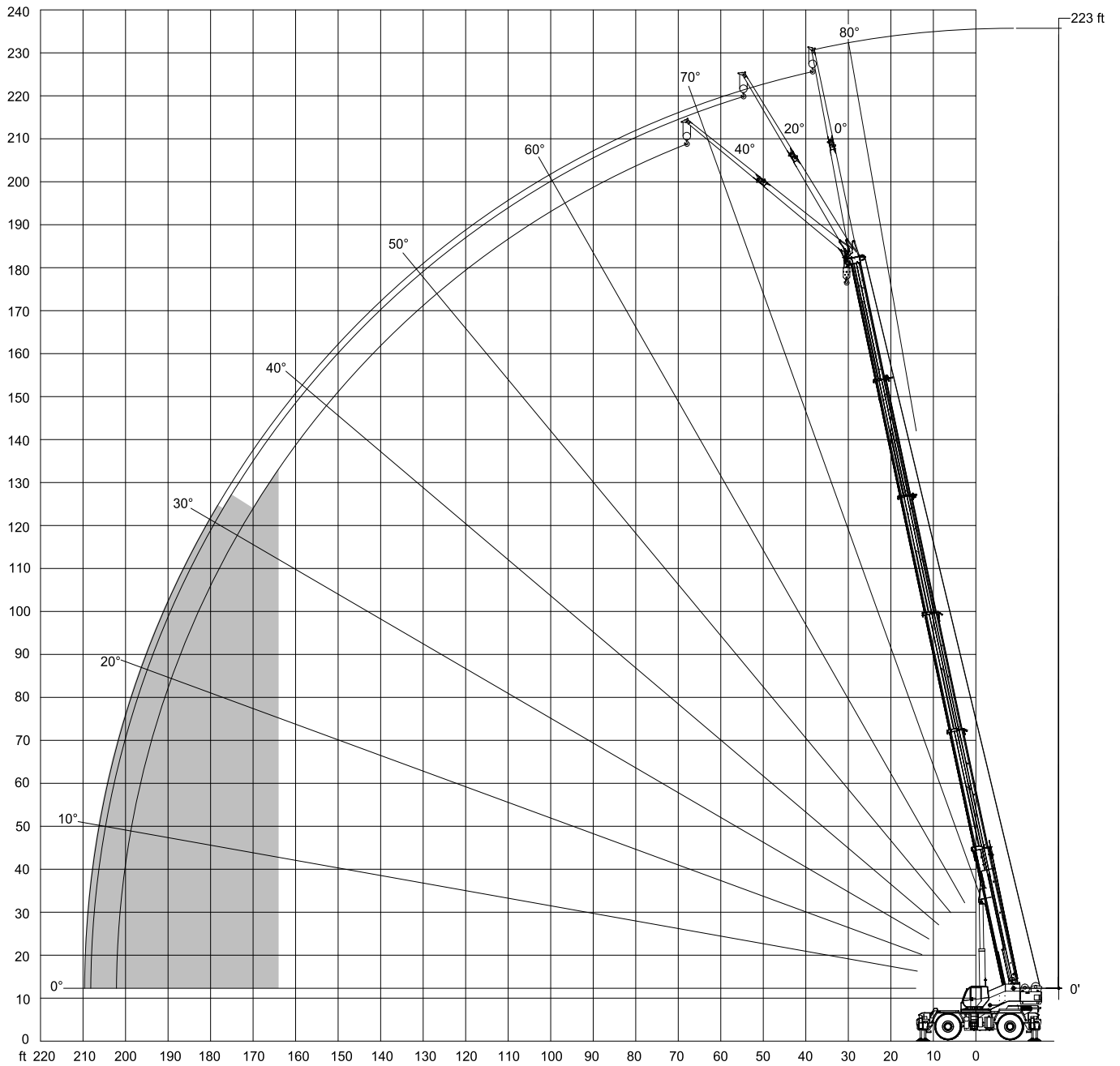

LOAD CHART – MAIN BOOM

RT 100



With Jib, 50 ft offset

 22,000 lbs

 26 ft (100%)

 360°

Standard ASME
B30.5

50 ft Offsettable Jib					
0°		20°		40°	
 ft	lbs	 ft	lbs	 ft	lbs
45	4,400	55	2,900	65	2,100
50	4,400	60	2,800	70	2,100
55	4,300	65	2,700	75	2,000
60	4,200	70	2,600	80	2,000
65	4,000	75	2,600	85	2,000
70	3,800	80	2,500	90	2,000
75	3,500	85	2,400	95	1,900
80	3,300	90	2,400	100	1,900
85	3,100	95	2,300	105	1,900
90	2,800	100	2,200	110	1,800
95	2,700	105	2,000	115	1,700
100	2,500	110	1,900	120	1,600
105	2,300	115	1,800	125	1,500
110	2,100	120	1,700	130	1,500
115	2,000	125	1,600	135	1,400
120	1,900	130	1,500	140	1,300
125	1,800	135	1,400	145	1,200
130	1,700	140	1,400	150	1,200
135	1,500	145	1,300	155	1,100
140	1,500	150	1,200	160	1,100
145	1,400	155	1,200	165	1,000
150	1,200	160	1,100	170	900
155	1,000	165	900	175	700
160	700	170	700	180	400
165	500	175	500		

Notes to lifting capacity

Lifting capacities do not exceed 85% of tipping load. Weight of hook blocks and slings is part of the load, and is to be deducted from the capacity ratings. Consult operation manual for further details.

Note: Data published herein is intended as a guide only and shall not be construed to warrant applicability for lifting purposes. Crane operation is subject to the computer charts and operation manual both supplied with the crane.

RANGE DIAGRAM - PICK & CARRY

RT 100

Mode 1

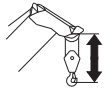
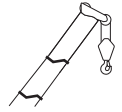

with hook block: 8.5 ft

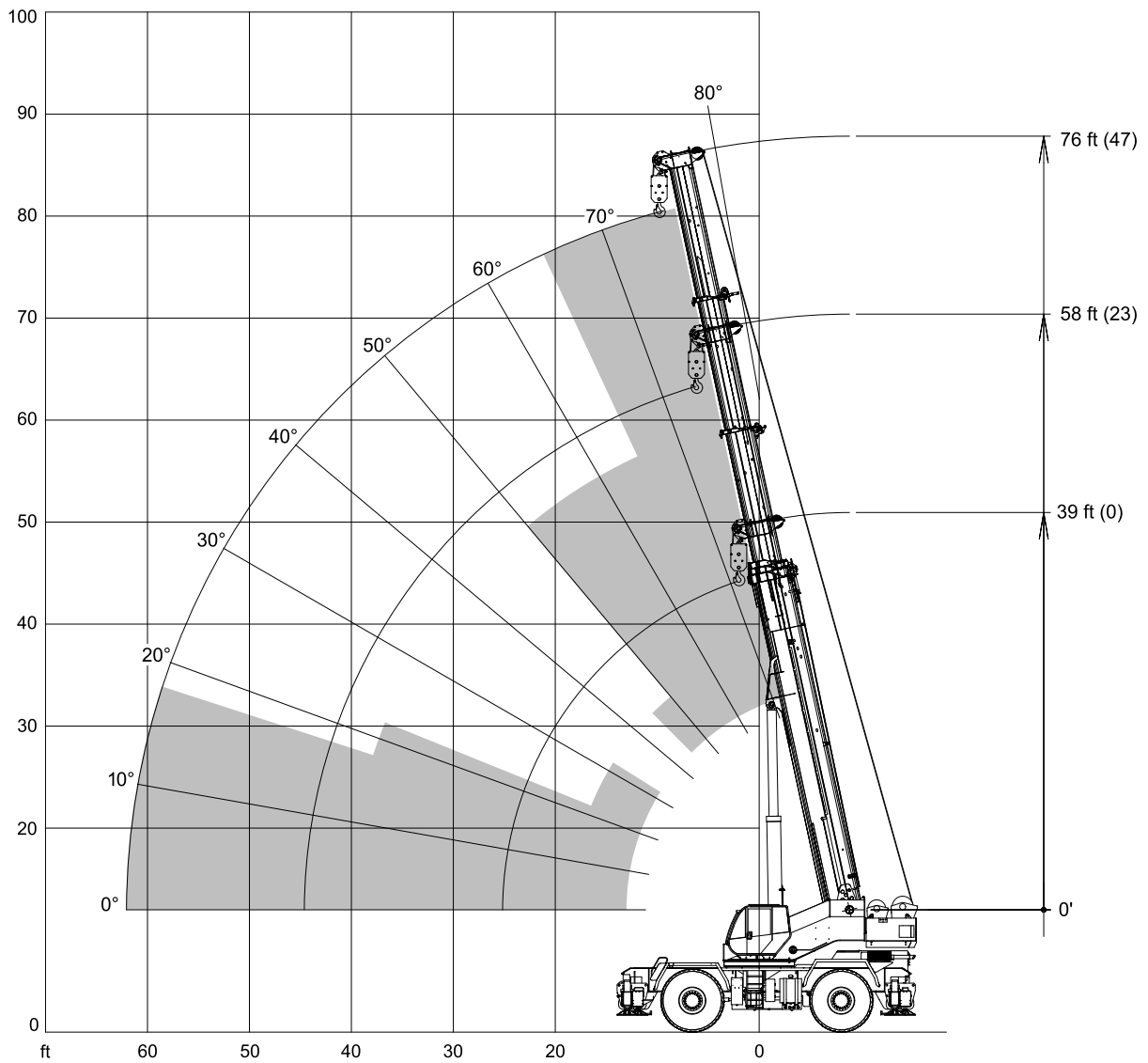

LOAD CHART – PICK & CARRY

RT 100

Mode 1

 22,000 lbs

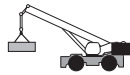

Standard ASME
B30.5









Boom		Travel Speed	
Radius	Length	360 degree rotation	Boom straight over front
ft	ft	0 mph	1 mph (creep)
		lbs	lbs
20	38	33,000	40,400
25	38	23,800	32,000
30	57	20,000	28,900
35	57	15,100	24,600
40	57	11,900	20,400
45	57	9,400	17,000
55	77	7,200	13,200
60	77	6,000	11,300
65	77	4,900	9,700

Notes to lifting capacity







Lifting capacities do not exceed 85% of tipping load. Weight of hook blocks and slings is part of the load, and is to be deducted from the capacity ratings. Consult operation manual for further details.

Note: Data published herein is intended as a guide only and shall not be construed to warrant applicability for lifting purposes. Crane operation is subject to the computer charts and operation manual both supplied with the crane.

Boom







Standard configuration:	
	6 sections hydraulic actuated, dual mode boom
	Elements 2 and 3 – synchronized extension Elements 4, 5 and 6 – synchronized extension Elements 4 and 5 – synchronized extension, element 6 retracted
	Min. / Max. 37.7 ft / 173.8 ft
	Main boom (min. / max.) 13.1 ft / 183.0 ft
	Boom elevation angle range (min. / max.) -1° / 78° Boom raising / lowering time 80 s / 120 s Boom extension / retraction time 180 s / 120 s
Optional configuration:	
	Single sheave
	One section, side stowable 27 ft Angular offsets 0°, 20° and 40° Two sections bi-fold, side stowable 50 ft Angular offsets 0°, 20° and 40°
	With one section jib (max.) 207 ft With two sections jib (max.) 230 ft
	Adjustable working light on the first section of the boom

Hoist, Rope and Hook



Standard configuration:	
	Grooved drum Storage capacity 990 ft
	Two speed ratios Without load in 5 th layer (Low range / Hi range) 138 ft/min / 236 ft/min Without load in 1 st layer (Low range / Hi range) 98 ft/min / 177 ft/min
	27 WARRINGTON xK7 Right hand lang lay
	0.71 in
	984 ft
	Minimum breaking strength 12,613 lbs Max. line pull permissible 14,523 lbs

		Optional configuration:	
	Hook ball 5 sheaves 7 sheaves		12 ton 75 ton 100 ton
	Grooved drum Storage capacity		607 ft
	Without load in 5 th layer Without load in 1 st layer		256 ft/min 197 ft/min
	27 WARRINGTON xK7 Right hand lang lay		
			0.59 in
			574 ft
	Minimum breaking strength Max. line pull permissible		44,130 lbs 8,826 lbs

Superstructure

		Standard configuration:	
			22,000 lbs
	Non stop Maximum speed without load		360° 1.2 rpm
	Hydraulic motor Planetary reducer		
	Automatically actuated, possible manual release		
		Optional configuration:	
	Adjustable working light on upperstructure frame		
	Removable counterweight		

Cab, Controls, Operator aids and Load limiter / Load indicator

		Standard configuration:
	Sliding door Hinged, tinted all glass skylight Six way adjustable seat	
	Armrest mounted dual axis electro-proportional joysticks Left hand joystick for slewing, boom telescoping, auxiliary hoist, swing brake release Right hand joystick for main hoist, boom elevation, horn Foot pedals controls for engine throttle and service brake Steering wheel column with gear selector on the left and directional light selector on the right Dashboard mounted switches for outrigger operation	



Electronic load indicator
Setup of working space limits





Electric heater and defroster
Air-conditioning

Carrier, Engine, Drive-line and Hydraulic system

		Standard configuration:	
	Hydraulic, independent extension:		
	Outrigger footprint area 100 % extended		688 ft ²
	Outrigger footprint area 50 % extended		443 ft ²
	Outrigger footprint area 0 % extended		260 ft ²
	Diameter of outrigger pads		24 in
	Area of outrigger pads		45.3 in ²
	Single outrigger jack extending and retracting time		11 s
Single outrigger beam extending and retracting time		8 s	
	Cummins QSB6.7 6 cylinders		
	Rated power		262 HP @ 2200 rpm
	Maximum gross torque		726 ft·lb @ 1500 rpm
	Intake: turbocharger with intercooler		
	Fuel type		Diesel
	Fuel tank capacity		79 gallons
	4 x 4 powershift with torque converter		
	Permanent 4WD		
	Rigid mounted front axle		
	Oscillating mounted rear axle		
	Differential lock on front axle and rear axle		
	Rear axles oscillation lock manual or automatic when superstructure is slewed 3° from centerline in either directions		
	Air over hydraulic service disc brake system		
	Parking brake on front axle		
	Hydraulic oil cooler on carrier		
	Hydraulic power steering		
	Front wheel steering		
	Four wheel steering concentric		
	Four wheel steering crab		
	Double variable displacement piston pump for boom luffing and telescoping, slewing, main and auxiliary hoist		
	Double gear pump for steering, outriggers and AC unit motor		
	Hydraulic oil tank capacity		264 gallons
		Optional configuration:	
	Kit for cold environment		

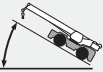
Vehicle performance

		Standard configuration:	
	Max. in 1 st gear Max. in 4 th gear		98.5 % 3.53 %
	Max. (4 th gear)		18.6 mph
	Min. Max.		-4 °F +113 °F

Tires

		Standard configuration:	
	Wide earth moving style tread (E3)		29.5R25

www.terexcranes.com

Effective Date: October 2010.

Product specifications and prices are subject to change without notice or obligation. The photographs and/or drawings in this document are for illustrative purposes only. Refer to the appropriate Operator's Manual for instructions on the proper use of this equipment. Failure to follow the appropriate Operator's Manual when using our equipment or to otherwise act irresponsibly may result in serious injury or death. The only warranty applicable to our equipment is the standard written warranty applicable to the particular product and sale and Terex makes no other warranty, express or implied. Products and services listed may be trademarks, service marks or trade-names of Terex Corporation and/or its subsidiaries in the USA and other countries. All rights are reserved. Terex® is a registered trademark of Terex Corporation in the USA and many other countries.

Copyright 2010 Terex Corporation

Terex Cranes, Global Marketing, Dinglerstraße 24, 66482 Zweibrücken, Germany
Tel. +49 (0) 6332 830, Email: info.cranes@terex.com, www.terexcranes.com

Brochure Reference: TC-DS-I-E-RT100-10.10



WORKS FOR YOU.™