

GEHL®

Form No.
50960010
Revision B
December
2012

RS5-19

Telescopic Handler

Serial Number 50651 and up



Operator's Manual

Indicator and Control Symbols



Read Operator's Manual



Parking Brake



Brake Failure



Safety Alert



Turn Signals



Hazard Flasher



Ignition Off



Ignition ON



Engine Start



Engine Coolant Temperature



Engine Oil Pressure



Engine Electrical Preheat



Volume Full

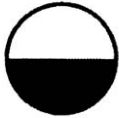

Volume Half Full

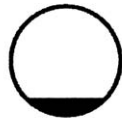

Volume Empty

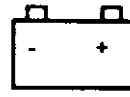

Battery



Engine Air Filter Restriction



Engine Failure



Hydraulic Oil



Hydraulic Filter Restriction



Transmission Temperature



Hourmeter



Lights



Work Lights



Fan



Wiper/Washer



Fasten Seat Belt



Crab Steer



2-Wheel Steer

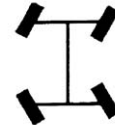

4-Wheel Steer



Raise Load



Lower Load



Tilt Rearward



Tilt Forward



Retract Load



Extend Load



Lift Point



Tie Down Point



Diesel Fuel



Fuel



Female Auxiliary Hydraulic Coupler



Male Auxiliary Hydraulic Coupler



Horn

Table of Contents

Chapter	Description	Page
	International Symbols	Inside Front Cover
1	Introduction	2
2	Specifications	4
3	Checklists	5, 7
4	SAFETY	8
5	Indicators and Controls	17
6	Operation and Adjustments	26
7	Lubrication	39
8	Service and Storage	42
9	Decals	57
10	Maintenance	61
	Engine Diagnostic Codes (EDC's)	65
	Electrical Schematics	67
	Hydraulic Schematics	68
	Load Zone Charts	69
	Standard Hardware Torque Data	71
	Index	72
	Warranty	Inside Back Cover

IDENTIFICATION INFORMATION

Write the Gehl Telescopic Handler serial number below.
 Refer to the model and serial number when inquiring about parts or service from your Gehl dealer.

MODEL NO.	RS5-19
SERIAL NO.	

The model and serial numbers for this machine are on a decal located inside the operator's station.

Chapter 1

INTRODUCTION

The information in this Operator's Manual was written to give the owner/operator assistance in preparing, adjusting, maintaining and servicing of the Telescopic Handler. More important, this manual provides an operating plan for safe and proper use of the machine. Major points of safe operation are detailed in the **SAFETY** chapter of this manual.

GEHL Company asks that you read and understand the contents of this manual COMPLETELY and become familiar with the machine before operating it.

The use of this Telescopic Handler is subject to certain hazards that cannot be eliminated by mechanical means, but only by the exercise of intelligence, care and common sense. It is therefore essential to have competent and careful operators, who are not physically or mentally impaired, and who are thoroughly trained in the safe operation of the equipment and the handling of the loads.

Throughout this manual information is provided that is set in *italic* type and introduced by the word **IMPORTANT** or **NOTE**. Be sure to read carefully and comply with the message or directive given. Following this information will improve operating and maintenance efficiency, help to avoid breakdowns and damage, and extend the machine's life. A chart of standard hardware torques is located in the back of this manual.

A storage pocket in the back of the seat is provided for storing the Operator's Manual. After using the manual, please return it to the pocket and keep it with the unit at all times! If this machine is resold, GEHL Company recommends that this manual be given to the new owner.

If this machine was purchased "used," or if the owner's address has changed, please provide your GEHL dealer or GEHL Company Service Department with the owner's name and current address, along with the machine model and serial number. This will allow the registered owner information to be updated, so that the owner can be notified directly in case of an important product issue, such as a safety update program.

"Right" and "left" are determined from a position sitting on the seat and facing forward.

The wide GEHL dealership network stands ready to provide any assistance required, including providing genuine GEHL service parts. All parts should be obtained from or ordered through your GEHL dealer. Give complete information about the part, and include the model and serial number of the machine. Record the serial number in the space provided on the previous page, as a handy record for quick reference.

GEHL Company reserves the right to make changes or improvements in the design or construction of any part without incurring the obligation to install such changes on any unit previously delivered.

GEHL Company, in cooperation with the Society of Automotive Engineers, has adopted this

Safety Alert Symbol

to identify potential safety hazards that if not properly avoided, could result in injury. When you see this symbol in this manual or on the machine itself, you are reminded to BE ALERT! Your personal safety is involved!

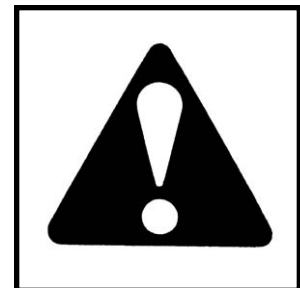

Identification

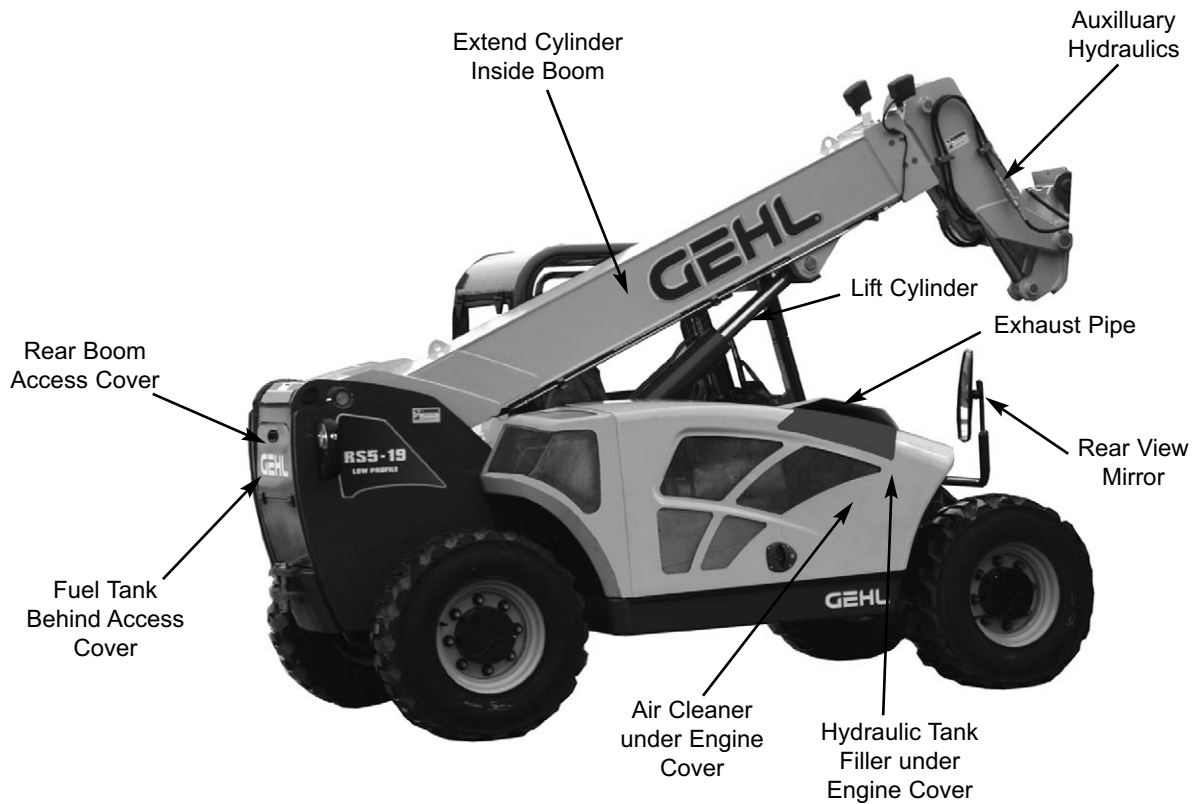
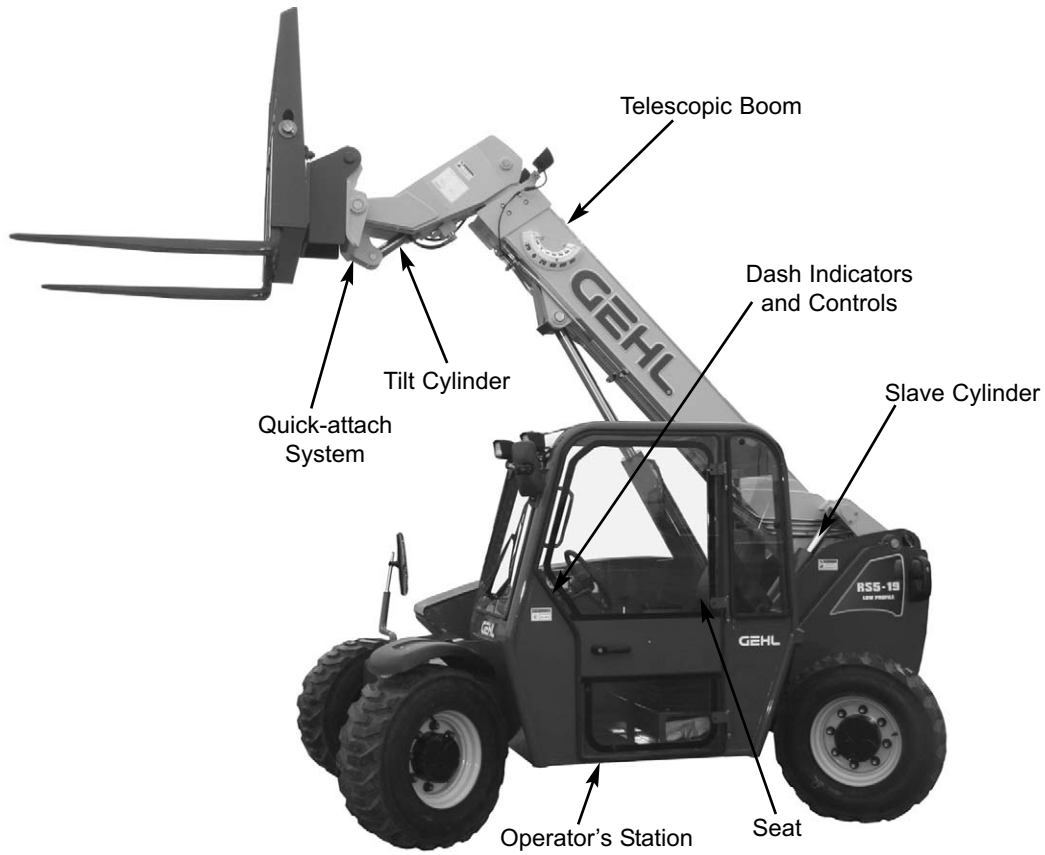

Chapter 2

SPECIFICATIONS

Lifting Performance

Maximum lift capacity:
5500 lbs. (2495 kg)

Maximum lift height:
19' 1" (5.8 m)

Capacity at maximum lift height:
3000 lbs. (1361 kg)

Max. forward reach to load center:
11' (3.35 m)

Capacity at maximum forward reach:
1850 lbs. (840 kg)

Maximum below grade reach:
0" (0 mm)

General Dimensions

Based on standard machine equipped with listed tires, 48" masonry carriage and 48" pallet forks.

Recommended tire type:
12 - 16.5 NHS 10-ply

Overall length, less forks:
148" (3.76 m)

Overall width:
71" (1.80 m)

Overall height:
76" (1.93 m)

Ground clearance: 10.5" (266 mm)

Wheelbase: 90" (2.29 m)

Outside turn radius: 132" (3.35 m)

Machine weight without attachment:
9,700 lbs. (4400 kg)

Instrumentation

Gauges: Fuel level, hourmeter, coolant temperature, Voltmeter, Engine speed

Monitoring lights:
Engine oil pressure, alternator, hydrostatic drive oil temperature, engine coolant temperature, air cleaner, low fuel, hydraulic filter, engine failure and glow indicator.

Visual indicators:
Boom angle, frame angle

Steering System

Steer Valve: Fixed-displacement rotary
Displacement/Rev: 7.3 cu. in. (120 cc)
System pressure: 2400 psi (165 bar)
Steer cylinders: 1 per axle
Steer mode valve:
3-position, 4-way solenoid with dash-mounted switch actuation
Steer modes: 2-wheel, 4-wheel, crab

Braking System

Service brakes: Oil-immersed inboard hydraulic wet-disc type; front axle
Manual foot pedal actuation

Parking brake: Spring-applied, hydraulic-release disc-type in front axle

Actuation is electric switch with engine running, automatic with engine off.

Electrical System

Type: 12-volt, negative ground
Battery: 550 minimum cold cranking amps
Circuit protection: Fuse panel
Backup alarm: 107 dB(A)
Horn: 111 dB(A)
Alternator: 95 amp

Service Capacities

Cooling System: 12 qts. (11.3 L)
50/50 mixture
Anti-freeze protection: -31°F (-35°C)
Pressure cap: 14 psi (1.0 bar)

Fuel tank: 17 gals. (64 L)
Hydraulic tank:
18 gals. (68 L)

Axles:
Differentials: 4 qts. (3.8 L) ea.
Planetaries:
Front: 27 oz. (0.8 L) ea.
Rear: 30 oz. (0.9 L) ea.
Transfer Case (front axle only):
8 oz. (0.23 liters)

Hydrostatic Transmission

Type: Rexroth A4VG56DA/32
Speeds: 2 fwd / 2 rev

Travel Speeds:
Low speed: fwd/rev 4 mph (6.4 km/h)
High speed: fwd/rev 15 mph (24 km/h)

Axles (front and rear)

Front Axle: Dana model 60-211-69
Drive/steer, limited-slip differential, full-time four-wheel drive
Rear Axle: Dana model 221-83
Drive/steer, open differential, full-time four-wheel drive

Engine

Natural Aspiration Yanmar 4TNV98
202 cu. in. (3.32 liters) displacement
68 hp (50.1 kW) @ 2500 rpm
164 ft.-lbs. (222 Nm) torque @ 1600 rpm
Oil capacity: 11.1 qts. (10.5 L)

Features:

In-line 4-cycle, 4-cylinder, direct-injection diesel fuel system, in-line 5 micron fuel pre-filter with water trap, and in-line 1 micron primary fuel filter, positive pressure lubrication, liquid pressurized cooling system, 19" (483 mm) suction fan, dry dual-element air cleaner, spin-on oil filter.

Hydraulic System

Type: Open-center
Pump: Single-section gear type

Displacement / revolution:
1.95 cu. in. (32 cc)

Flow @ 2530 RPM:
20 gpm (76 L/min)

Main relief pressure:
3350 psi (231 bar)

Steer relief pressure:
2400 psi (166 bar)

Hydraulic filter:
Return type, 16-micron media, replaceable element.
Rated flow: 35 gpm (132 L/min)
Rated pressure: 1000 psi (70 bar)
By-pass pressure (full flow):
50 psi (345 kPa)

Chapter 3

CHECKLISTS

PRE-DELIVERY

The following Checklist is an important reminder of inspections that **MUST** be made before delivering the Telescopic Handler to the customer. Check off each item after the prescribed action is taken.

√ Check that:

- NO parts of machine have been damaged in shipment. Check for such things as dents and loose or missing parts; correct or replace components as required.
- Battery is securely mounted and not cracked. Cable connections are tight. Electrolyte at proper level.
- Cylinders, hoses and fittings are not damaged, leaking or loosely secured.
- Oil, fuel and air filters are not damaged, leaking or loosely secured.
- All grease fittings have been properly lubricated and no fittings are missing; see Lubrication chapter of this manual.
- Wheel nuts are torqued to 450 ft.-lbs. (610 Nm).
- Tires are inflated to 65 psi (448 kPa) cold.
- Hydraulic system reservoir, engine crankcase, engine coolant, transmission and axles are filled to the proper operating fluid levels.
- All adjustments have been made to comply with the settings given in this manual and in the separate engine manual.
- All guards, shields and decals are in place and securely attached.
- Model and serial numbers for this unit are recorded in space provided on this page and page 1.

Start the machine and test-run the unit while checking that proper operation is exhibited by all controls.

√ Check that:

- All indicators (lamps, switches, etc.) function properly.
- All hand and foot controls operate properly.
- Boom, Quick-attach System with attachment tool all function properly.
- No hydraulic system leaks when under pressure.
- Listen for abnormal noises or vibrations; if detected, determine their cause and repair as necessary.

I acknowledge that the pre-delivery procedures were performed on this unit as outlined above.

Dealership's Name

Dealer Representative's Name

Date Checklist Filled Out

Machine Model #

Machine Serial #

Engine Serial #

DELIVERY

√ Check that:

The following Checklist is an important reminder of valuable information that **MUST** be passed on to the customer at the time the unit is delivered. Check off each item as you explain it to the customer.

- Review with the customer the contents of this manual and the AEM Safety Manual and for the following:
 - The *Index* at the back, for quickly locating topics;
 - The Safety, Indicators and Controls, and Operation and Adjustments chapters for information regarding safe use of the machine.
 - The Lubrication, Service and Storage, and Maintenance chapters for information regarding proper maintenance of the machine. Explain that regular lubrication and maintenance are required for continued safe operation and long life.
 - Give this Operator's Manual and the AEM Safety Manual to the customer and instruct them to be sure to read and completely understand their contents **BEFORE** operating the unit.
 - Remind the customer of U.S. OSHA regulation 1910.178 (I), which specifies operator training requirements.
 - Explain that the customer must consult the engine manual (provided) for related specifications, operating adjustments and maintenance instructions.
 - Completely fill out the Owner's Registration, including customer's signature, and return it to the Company.

Customer's Signature

Date Delivered

(Dealer's File Copy - Remove at Perforation)

INTENTIONALLY BLANK

(To be removed as Dealer's file copy)

Chapter 3

CHECKLISTS

PRE-DELIVERY

The following Checklist is an important reminder of inspections that **MUST** be made before delivering the Telescopic Handler to the customer. Check off each item after the prescribed action is taken.

√ **Check that:**

- NO parts of machine have been damaged in shipment. Check for such things as dents and loose or missing parts; correct or replace components as required.
- Battery is securely mounted and not cracked. Cable connections are tight. Electrolyte at proper level.
- Cylinders, hoses and fittings are not damaged, leaking or loosely secured.
- Oil, fuel and air filters are not damaged, leaking or loosely secured.
- All grease fittings have been properly lubricated and no fittings are missing; see Lubrication chapter of this manual.
- Wheel nuts are torqued to 450 ft.-lbs. (610 Nm).
- Tires are inflated to 65 psi (448 kPa) cold.
- Hydraulic system reservoir, engine crankcase, engine coolant, transmission and axles are filled to the proper operating fluid levels.
- All adjustments have been made to comply with the settings given in this manual and in the separate engine manual.
- All guards, shields and decals are in place and securely attached.
- Model and serial numbers for this unit are recorded in space provided on this page and page 1.

Start the machine and test-run the unit while checking that proper operation is exhibited by all controls.

√ **Check that:**

- All indicators (lamps, switches, etc.) function properly.
- All hand and foot controls operate properly.
- Boom, Quick-attach System with attachment tool all function properly.
- No hydraulic system leaks when under pressure.
- Listen for abnormal noises or vibrations; if detected, determine their cause and repair as necessary.

I acknowledge that the pre-delivery procedures were performed on this unit as outlined above.

Dealership's Name

Dealer Representative's Name

Date Checklist Filled Out

Machine Model # Machine Serial # Engine Serial #

DELIVERY

√ **Check that:**

The following Checklist is an important reminder of valuable information that **MUST** be passed on to the customer at the time the unit is delivered. Check off each item as you explain it to the customer.

- Review with the customer the contents of this manual and the AEM Safety Manual and for the following:
 - The *Index* at the back, for quickly locating topics;
 - The Safety, Indicators and Controls, and Operation and Adjustments chapters for information regarding safe use of the machine.
 - The Lubrication, Service and Storage, and Maintenance chapters for information regarding proper maintenance of the machine. Explain that regular lubrication and maintenance are required for continued safe operation and long life.
- Give this Operator's Manual and the AEM Safety Manual to the customer and instruct them to be sure to read and completely understand their contents **BEFORE** operating the unit.
- Remind the customer of U.S. OSHA regulation 1910.178 (I), which specifies operator training requirements.
- Explain that the customer must consult the engine manual (provided) for related specifications, operating adjustments and maintenance instructions.
- Completely fill out the Owner's Registration, including customer's signature, and return it to the Company.

Customer's Signature

Date Delivered

(Pages 5 and 6 have been removed at perforation)

Chapter 4



SAFETY



The above Safety Alert Symbol means **ATTENTION! ALWAYS BE ALERT! YOUR SAFETY IS INVOLVED!** It stresses an attitude of safety awareness and can be found throughout this Operator's Manual and on the machine itself.

Before attempting to operate this equipment, read and study the following safety information. In addition, be sure that everyone who operates or works with this equipment, whether family member or employee, is familiar with these safety precautions.

Gehl Company ALWAYS takes the operator's safety into consideration when designing its machinery, and guards exposed moving parts for his/her protection. However, some areas cannot be guarded in order to assure proper operation. Further, this Operator's Manual and decals on the machine warn of additional hazards and should be read and observed closely.

DANGER

"DANGER" indicates an imminently hazardous situation that, if not avoided, will result in death or serious injury.

WARNING

"WARNING" indicates a potentially hazardous situation that, if not avoided, could result in death or serious injury.

CAUTION

"CAUTION" indicates a potentially hazardous situation that, if not avoided, may result in minor or moderate injury. It may also alert to unsafe practices.

REMEMBER! It is the owner's responsibility for communicating information on the safe use and proper maintenance of this machine! This includes providing understandable interpretations of these instructions for operators who are not fluent in reading English.

It is the responsibility of the operator to read and understand the Operator's Manual and other information provided and use the correct operating procedure. Machines should be operated only by qualified operators.

MANDATORY SAFETY SHUTDOWN

PROCEDURE

BEFORE cleaning, adjusting, lubricating or servicing the unit:

1. Stop machine on a level surface. (AVOID parking on a slope, but if necessary, park across the slope and block the tires.)
2. Fully retract the boom and lower the attachment tool to the ground. Idle engine for gradual cooling.
3. Place controls in neutral and apply parking brake.
4. Shut off the engine and remove the key.

ONLY when you have taken these precautions can you be sure it is safe to proceed. Failure to follow the above procedure could lead to death or serious bodily injury.



SAFETY



WARNING

U.S. OSHA regulations require employers in general industry and the construction, shipyard and cargo-handling industries (excepting agricultural operations) to ensure that forklift operators are competent, as demonstrated by successful completion of a training course.

The training course must consist of a combination of formal instruction and practical training, including both forklift-related and workplace-related topics, and evaluation of the operator's performance in the workplace.

All operator training and evaluation is to be conducted by persons who have the knowledge, training and experience to train and evaluate operators.

WARNING

U.S. OSHA regulations effective November 8, 2010 (29 CFR Part 1926, Subpart CC - Cranes and Derricks in Construction) include requirements for employers that use powered industrial trucks ("forklifts") configured to hoist (by means of a winch or hook) and move suspended loads horizontally. In particular, this regulation applies to any rough-terrain forklift (e.g., "telescopic handler") equipped with a jib or truss boom with a hook (with or without a winch), or a hook assembly attached to the forks. [Note: This regulation is in addition to the OSHA regulation that requires specific forklift operator training: §1910.178(l).]

When a forklift / telescopic handler is configured and used for hoisting, the employer must ensure that:

1. Forklift, lift equipment and rigging have been inspected (each shift, month and

year) and are in good, safe condition and properly installed.

2. An operator's manual and applicable load charts are on the forklift.
3. Work zone ground conditions can support the equipment and load. Any hazardous conditions in the work area have been identified, and the operator notified.
4. Equipment is being used within its rated capacity and in accordance with the manufacturer's instructions.
5. Operator and crew members have been trained in the safe use and operation of the equipment, including how to avoid electrocution.
6. During use, no part of the equipment, load line or load will be within the minimum clearance distance specified by OSHA [10 feet (3.0 m), and more for lines rated over 50 kV] of any energized power line, and any taglines used are non-conductive.
7. In addition, for lift equipment with a rated capacity greater than 2000 lbs. (907 kg), the employer must ensure that:
 - a.) An accessible fire extinguisher is on the forklift;
 - b.) Monthly and annual inspections are performed and documented, and records retained (three months for monthly, one year for annual);
 - c.) Before November 10, 2014, operators must have had the additional training and qualification / certification required by OSHA regulations §1926.1427 and §1926.1430.

Note: Refer to the full text of the OSHA crane regulation (29 CFR Part 1926, Subpart CC) for a detailed description of the regulatory requirements.



SAFETY



WARNING

ALWAYS maintain a safe distance from electric power lines and avoid contact with any electrically charged conductor or gas line. It is not necessary to make direct contact with a power line for power to ground through the structure of the machine. Keep the boom at least 10 ft. (3 m) from all power lines. Accidental contact or rupture can result in electrocution or an explosion. Contact the North American One-Call Referral System at (888) 258-0808 for the local “Digger’s Hotline” number or proper local authorities for utility line locations before starting to dig!

Additional Safety Reminders

- User/operator safety practices, as established by industry standards, are included in this Operator’s Manual and intended to promote safe operation of the machine. These guidelines do not preclude the use of good judgment, care and common sense as may be indicated by the particular jobsite work conditions.
- It is essential that operators be physically and mentally fit, free of mind-altering drugs and chemicals, and thoroughly trained in the safe operation of the machine. Such training should be presented completely to all new operators and not condensed for those claiming previous experience. Information on operator training is available from several sources, including the manufacturer.
- Some illustrations used in this manual may show doors, guards and shields open or removed for illustration purposes ONLY. BE SURE that all doors, guards and shields are in their proper operating positions before starting the engine.

Before Operation Safety Reminders

- Check brakes, steering, and hydraulic system prior to starting operation. Operate all controls to ensure proper operation. Observe all gauges and indicators for proper operation. If any malfunctions are found, correct the cause prior to using the machine.
- ALWAYS wear appropriate personal protective equipment for the job and working conditions. Hard hats, goggles, protective shoes, gloves, reflector-type vests, respirators and ear protection are examples of types of equipment that may be required. DO NOT wear loose fitting clothing, long hair, jewelry or loose personal items while operating or servicing the machine.
- ALWAYS check the job site for terrain hazards, obstructions and people. Remove all objects that do not belong in or on the machine and its equipment.
- Walk around the machine and warn all personnel who may be servicing the machine or who are in the machine path prior to starting. DO NOT start until all personnel are clearly away from the machine.

Operation Safety Reminders

- Any or all of the following elements may affect the stability of the machine: terrain, engine speed, type of load being carried and placed, improper tire inflation, weight of the attachment tool, and abrupt movement of any control lever. **IF YOU ARE NOT CAREFUL WHILE OPERATING THIS MACHINE, ANY OF THE ABOVE FACTORS COULD CAUSE THE MACHINE TO TIP AND THROW YOU OUT OF THE OPERATOR’S STATION, WHICH MAY CAUSE SERIOUS BODILY INJURY OR DEATH!**
- ALWAYS wear the seat belt provided to prevent being thrown from the machine. If you are in an overturn:
 - DO NOT jump!
 - Hold on tight and stay with the machine!
 - Lean away from the fall!



SAFETY



- ALWAYS keep hands, feet and arms inside of the operator's station when operating the machine!
- DO NOT depend on the backup alarm to clear bystanders out of the path of the machine. Always look in the direction of travel. Look to the rear before backing.
- ALWAYS use the recommended hand holds and steps with at least three points of support when getting on and off the machine. Keep steps and platform clean. Face the machine when climbing up and down.
- DO NOT raise or drop a loaded fork or bucket suddenly. Abrupt movements under load can cause serious instability.
- Study the load chart carefully. It shows maximum capacity to be lifted and placed at specific outward and upward distances. ALWAYS be aware of load weights prior to attempting lift and placement with this machine.
- DO NOT exceed the machine's rated operating capacity for the type of attachment tool being used.
- DO NOT allow minors or any unqualified personnel to operate or be near the machine unless properly supervised.
- DO NOT start the engine or operate any controls unless properly seated in the operator's seat!
- DO NOT run the engine in an enclosed area without providing proper ventilation for the exhaust. Exhaust gases contain carbon monoxide, an odorless and deadly gas. Internal combustion engines deplete the oxygen supply within enclosed spaces and may create a serious hazard unless the oxygen is replaced. This includes the atmosphere within the cab when equipped.
- DO NOT leave the operator's station with the boom and attachment tool raised. ALWAYS lower the boom and attachment tool to the ground, shut off the engine and engage the parking brake BEFORE leaving the operator's station.
- NEVER travel with the boom above the carry position (attachment tool should be at minimum ground clearance.) Boom should be fully retracted.
- DO NOT drive too close to an excavation or ditch. BE SURE that the surrounding ground has adequate strength to support the weight of the machine and the load it is carrying.
- DO NOT turn quickly while traveling on a slope or operate the machine beyond the grade and slope limits noted in the Operation and Adjustments chapter of the Operator's Manual.
- NEVER allow any riders on this machine or use as a lift for personnel. This is strictly a single-seat, NO passenger machine!
- When road travel is required, know and use the signaling devices on the machine. Provide an escort and Slow-Moving Vehicle (SMV) emblem when required.
- If necessary to park on a slope, park across the slope and block the tires.

Servicing Safety Reminders

- ALWAYS be aware of and avoid pinch-point areas on the machine, such as wheels-to-frame, cylinders-to-frame, boom- and attachment-tool-to-frame.
- NEVER attempt to by-pass the keyswitch to start the engine. ONLY use the jump-starting procedure detailed in the Service and Storage chapter.
- NEVER use your hands to search for hydraulic fluid leaks. Instead use a piece of paper or cardboard. Escaping fluid under pressure can be invisible and can penetrate the skin, causing serious injury. If any fluid is injected into your skin, see a doctor at once. Injected fluid MUST be surgically removed by a doctor familiar with this type of injury or gangrene may result.



SAFETY



- ALWAYS wear safety glasses with side shields when striking metal against metal. In addition, it is also recommended that a softer (chip-resistant) material be used to cushion the blow. Failure to heed could lead to serious injury to the eyes or other parts of the body.
- DO NOT refill the fuel tank when the engine is hot. Allow engine to cool down before refilling to prevent hot engine parts from igniting the fuel if it should spill or splash.
- DO NOT smoke while filling the fuel tank, working on the fuel or hydraulic systems, or working around the battery.
- DO NOT fill the fuel tank completely. Allow room for expansion. Maintain control of the fuel filler nozzle when filling the tank. Use the correct fuel grade for the operating season.
- NEVER use fuel for cleaning purposes.
- DO NOT remove the radiator cap after the engine has reached operating temperature or if it is overheated. At operating temperatures, the engine coolant will be extremely hot and under pressure. ALWAYS wait for the engine to cool before attempting to relieve pressure and remove the radiator cap. Failure to heed this warning could result in severe burns.
- DO NOT loosen or disconnect any hydraulic lines, hoses or fittings without first relieving hydraulic circuit pressure. Also, be careful not to touch any hydraulic components that have been in recent operation because they can be extremely hot and can burn you!
- Avoid lubrication or mechanical adjustments with the machine in motion or the engine running. If the engine must be running to make certain adjustments, place the equipment in a safe position, place the transmission in neutral, apply the parking brake, securely block the wheels and use extreme caution.
- To ensure continued safe operation, replace damaged or worn-out parts with genuine Gehl service parts before using this equipment.

Modifications, Nameplates, Markings and Capacities

- Modifications and additions that affect capacity or safe operation must never be performed without the manufacturer's prior written approval. Where such authorization is granted, any applicable markings are to be changed accordingly.
- All attachment tools MUST be marked to identify the attachment tool and the total capacity with the attachment tool at maximum elevation with the load laterally centered.
- ALWAYS be sure all nameplates, warnings and instruction markings are in place and legible. Local government regulations may require specific decals, which are the responsibility of the owner to provide.

Safety Guards and Warning Devices

- This machine is fitted with a Roll-Over Protective Structure (ROPS) and Falling Object Protective Structure (FOPS) in accordance with industry standards. The structure is intended to offer protection to the operator in case of an overturn and from falling objects, but it cannot protect against every possible hazard. Therefore it should not be considered a substitute for good judgment and safe practices in operating the machine. If the ROPS / FOPS structure is damaged, it must be replaced to restore the protection it provides.
- This machine is equipped with a horn and backup alarm. The user must determine if operating conditions require the machine to be equipped with additional devices (mirrors, rotating beacon, etc.) and be responsible for providing and maintaining such devices.



SAFETY

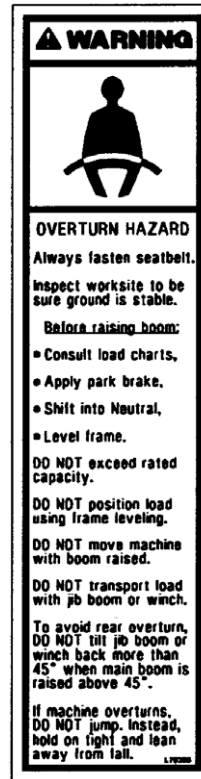
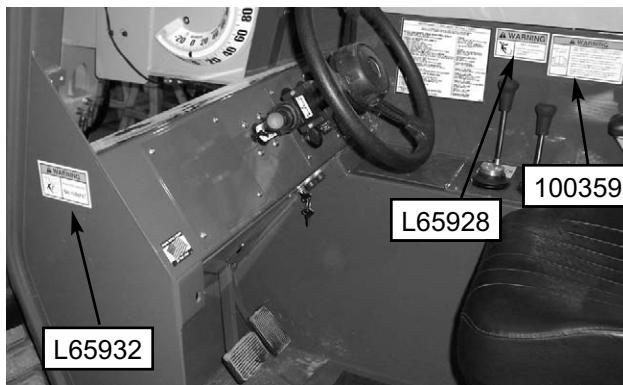
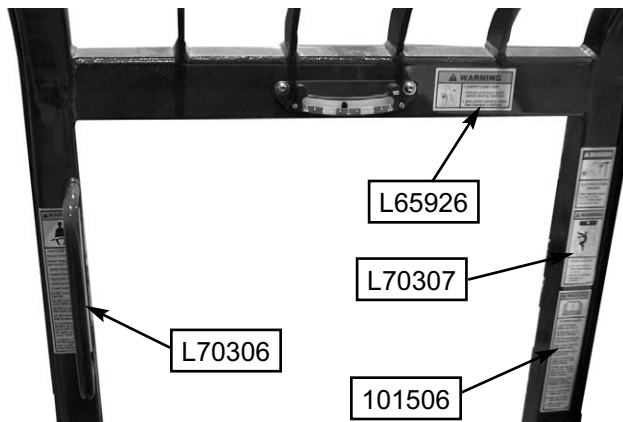

L70306

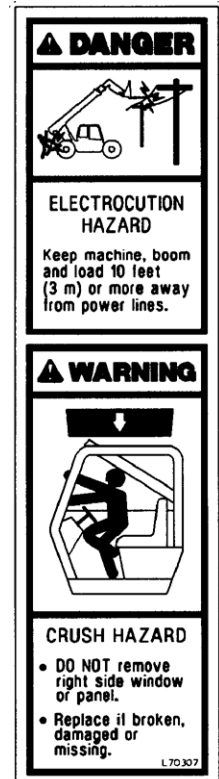

L70307

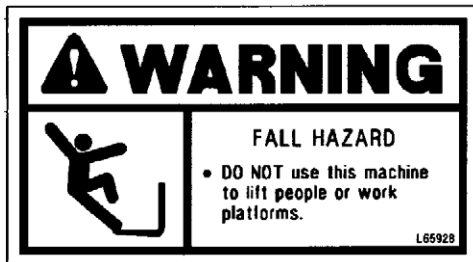

L65928



L65932

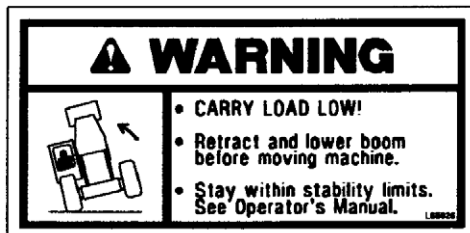

L65926

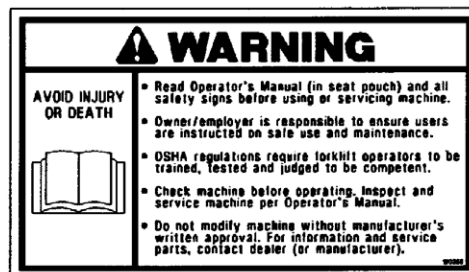

100359



101506



SAFETY

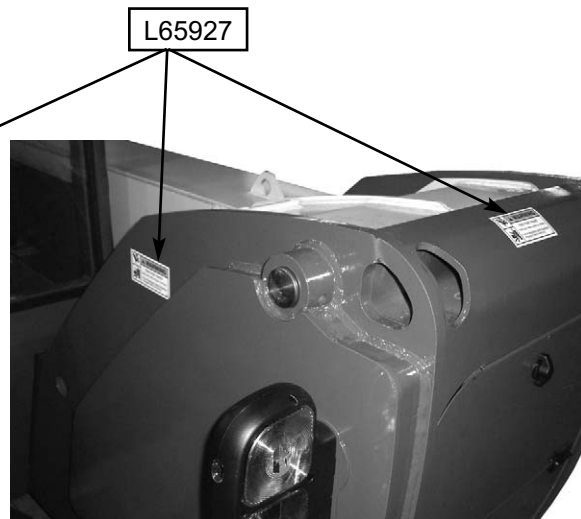
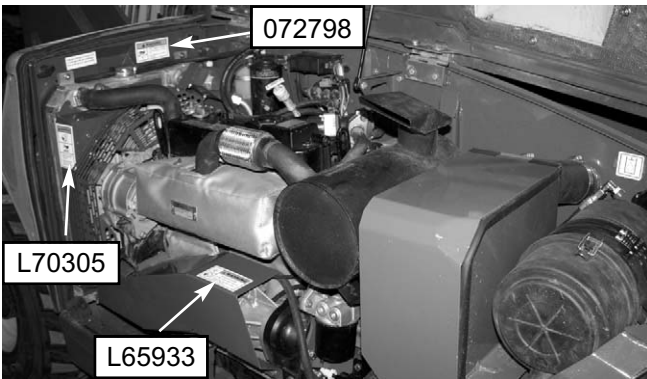
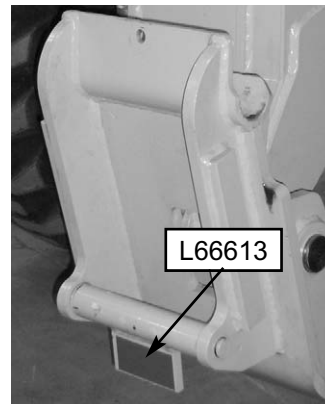
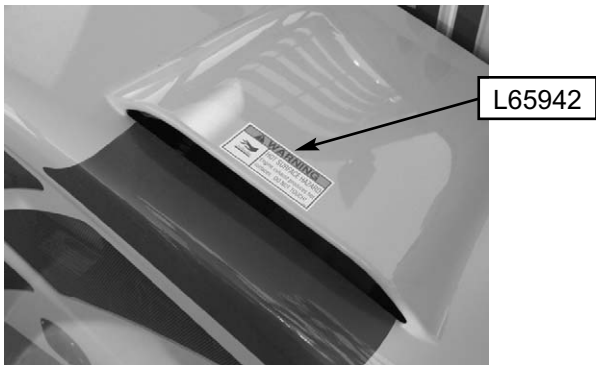



SAFETY



	<p>WARNING</p> <p>PINCH POINT HAZARD</p> <ul style="list-style-type: none"> • Keep clear when engine is running. • Follow <u>Mandatory Safety Shutdown Procedure</u> before servicing. <p><small>L65927</small></p>
--	---

L65927

072798

WARNING	
	<p>HOT LIQUID HAZARD</p> <ul style="list-style-type: none"> • DO NOT remove hot radiator cap. • Allow engine to cool before servicing. <p><small>072798</small></p>

	<p>WARNING</p> <p>RUN-OVER HAZARD</p> <ul style="list-style-type: none"> • DO NOT bypass starter solenoid. • Follow jump-starting procedure in Operator's Manual. <p><small>L65933</small></p>
--	--

L65933

WARNING	
<ul style="list-style-type: none"> • Keep hands away when engine is running. • Stop engine and allow it to cool before servicing. <p><small>L70305</small></p>	

L70305

WARNING	
	<p>FALL HAZARD</p> <ul style="list-style-type: none"> • DO NOT use this machine to lift people or work platforms. <p><small>L65928</small></p>

L65928

WARNING	
	<p>HOT SURFACE HAZARD</p> <p>Engine exhaust produces hot surfaces. DO NOT TOUCH!</p> <p><small>L65942</small></p>

L65942

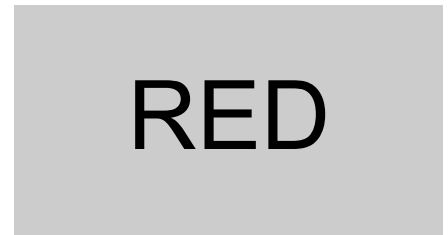

RED

L66613

INTENTIONALLY BLANK

Chapter 5

INDICATORS AND CONTROLS

CAUTION

Before operating the Telescopic Handler, become familiar with and know how to use ALL safety devices and controls. Know how to stop the machine operation before operating it. This Gehl machine is designed and intended to be used ONLY with a Gehl Company attachment tool, or a Gehl Company approved accessory or referral attachment tool. Gehl Company cannot be responsible for safety if the machine is used with an unapproved accessory or attachment tool.

GUARDS AND SHIELDS

Whenever possible and without affecting machine operation, guards and shields are used to protect potentially hazardous areas. In many places, decals are also provided to warn of potential hazards and to display special operating procedures.

WARNING

Read and thoroughly understand all safety decals on the Telescopic Handler before operating it. DO NOT operate the machine unless all factory-installed guards and shields are properly secured in place.

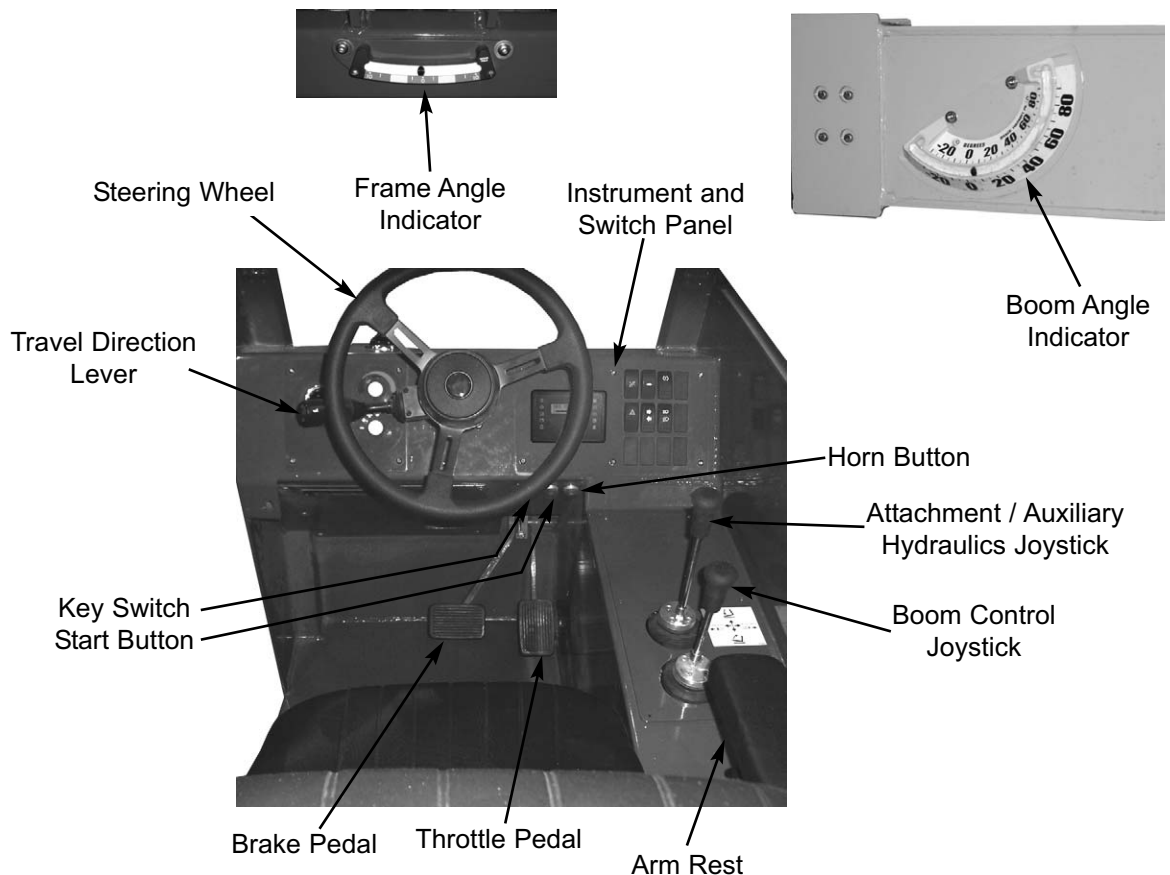

Operator's Compartment and Indicators/Controls Locations

DASH PANEL AREA

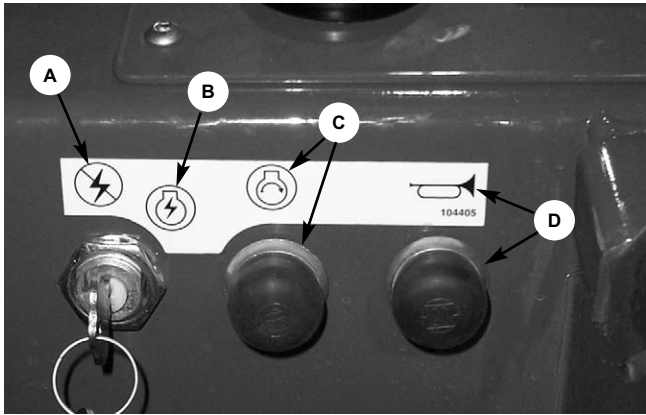

Key Switch, Start and Horn Buttons

A - Key switch OFF: When the key is vertical in the keyswitch, power is disconnected from the battery to the control and instrument panel electrical circuits. Also, this is the only position in which the key can be inserted or removed.

B - Key switch ON: When the key is turned one position clockwise from the vertical (OFF) position, power from the battery is supplied to all controls and multi-function display panel electrical circuits. Indicators on the multi-function display should light up momentarily.

When the key is in this position, the engine pre-heat indicator will stay on until the engine is pre-heated. In colder temperatures the pre-heat indicator will stay lit for 3-30 seconds. When the pre-heat indicator light goes out the engine can be started.

C - Start Button: With keyswitch in ON position, press the button to activate the starter. Release it as soon as the engine starts.

NOTE: If the engine requires repeated attempts to start, the key **MUST** be returned to the OFF position between starting attempts to prevent battery run down.

IMPORTANT: Do not use additional starting aids such as ether injection when using the electrical engine preheat.

D - Horn Button: With the keyswitch ON, press the horn button to activate warning sound.

Load Zone Charts: A set of flip charts show lift height and reach limits relative to the load weight being handled with various attachment tools.

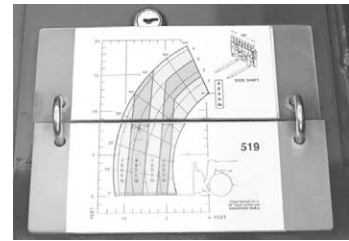

INSTRUMENT AND SWITCH PANEL

Located to the right of the steering wheel, this panel contains the instrument gauges, indicator lamps and function switches.



Instrument and Switch Panel

Instrumentation

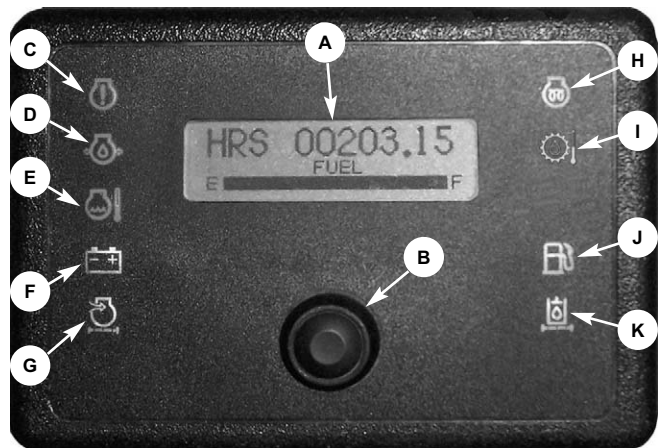

A - Multi-Function Display Screen: This screen displays the following functions:

- fuel level at all times,
- engine coolant temperature,
- engine speed,
- voltmeter
- hourmeter
- 250 hour maintenance reminder
- error fault codes

B - Scroll Button: Pressing this button changes the function displayed in the multi-function display screen.

A1 - Fuel Level Gauge: The fuel level is displayed at all times in the lower portion of the display. It indicates the amount of fuel remaining in the fuel tank.

A2 - Engine Coolant Temperature: Press button “B” until “TEMP” is displayed. It indicates the temperature of the engine coolant. Under normal conditions, this should indicate approximately 185°F (85°C).

A3 - Engine Speed: Press button “B” until “RPM” is displayed. This indicates the engine speed.

A4 - Voltmeter: Press button “B” until “VOLTS” is displayed. This indicates the voltage output from the alternator.

A5 - Hourmeter: Press button “B” until “HRS” is displayed. It indicates the total operating time of the machine and should be used for keeping the maintenance log.

A6 - Maintenance Reminder: After every 250 hours a reminder will display: “ROUTINE MAINTENACE IS REQUIRED — CHECK OPERATOR’S MANUAL.” Perform the required maintenance, and then clear the message by pressing and holding button “B” until the message is cleared.

NOTE: *The maintenance reminder message must display at least three minutes before it can be cleared by pressing and holding button “B”.*

A7 - Error Fault Code: Error codes and a short error description are displayed in this screen. The error code will clear when the error is corrected.

Indicator Lamps

C - Engine Failure: This lamp when lit, alerts the operator of a fault condition. Refer to the multi-function display screen for error codes.

D - Engine Oil Pressure Lamp: This lamp indicates when the engine lubricating oil pressure is too low. During normal operation, with the engine running, this lamp should be off. During starting and when the ignition is on but the engine is not running, this lamp will be on.

IMPORTANT: *If this lamp comes on during normal operation, stop the engine immediately! After allowing the oil to drain down for a few minutes, check the engine oil level. Maintain oil level at the FULL mark on the dipstick.*

E - Engine Coolant Temperature Lamp: This lamp indicates when the temperature of the engine coolant is too high.

IMPORTANT: *If this lamp comes on during normal operation with the engine running, STOP the engine as soon as possible and check the engine cooling system.*

F - Alternator Lamp: This lamp indicates the condition of the electrical charging system. During normal operation, this lamp should be off. If the charge rate is too high or too low, this lamp will come on.

G - Air Cleaner Restriction Indicator Lamp: If this lamp comes on, the engine air filter requires service.

H - Engine Pre-heat Indicator Lamp: When lighted this lamp indicates that the cold weather starting aid is in use.

I - Hydrostatic Transmission Oil Temperature Lamp: This lamp indicates when the temperature of the transmission oil is too high. During normal operation this lamp should be off, indicating that the transmission oil system is at the proper temperature.

IMPORTANT: *If this lamp comes on during normal operation, a problem may exist in the transmission oil system. Stop the machine immediately and investigate the cause of the problem!*

J - Low Fuel Lamp: This lamp indicates a low fuel situation. The fuel tank should be filled as soon as possible.

K - Hydraulic Oil Filter Restriction Lamp: If this lamp comes on, the hydraulic oil filter requires service.

Switch Panel

The switch panel contains three rows of switches for the operation of standard and optional equipment on the telescopic handler.



Top Row Switches

Switches have graphic symbols to indicate function and effect. The following mode descriptions start with the first switch on the left.

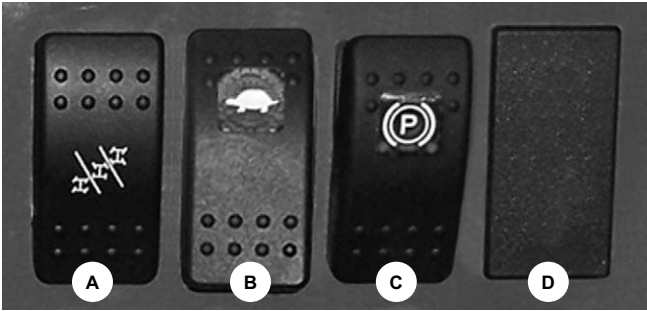

A - Steering Mode: This 3-position switch is used to select among the three steering modes. The upper position selects the 4-wheel steering mode. This mode selects all-wheel steering for making tighter turns, usually on a jobsite. The center position selects the 2-wheel steering mode. This mode selects front wheel steering only, used for higher speed travel. The lower position selects the crab steering mode. This mode is used when a small amount of side shift is needed for picking or placing a load.

NOTE: *The rear wheels are not self-centering. Make sure all wheels are in a straight-ahead position before changing the steering mode.*

Any of the steering modes can be used in both forward and reverse travel. The operator should learn to anticipate changes in machine movement if the steering mode must be changed.

B - High/Low Speed: This switch is used to select the travel speed. Press the top of the switch to select low speed, used for load pickup and placement, or whenever low speed operation is desired. Press the bottom of the switch to select high speed, used for road travel.

IMPORTANT: *Be sure machine is stopped before changing travel speeds.*

C - Parking Brake: When the machine is parked, this switch should be pressed to actuate the parking brake mechanism in the front axle.



WARNING

Unattended machine hazard.

Activate parking brake switch and lower attachment tool to ground before leaving machine. An unattended machine can move or roll and cause death or serious injury to operator or bystanders.

Periodically check the parking brake operation to verify that it has adequate holding power. Always be sure the parking brake switch is off when resuming machine operation.

D - Blank

Middle Row Switches

Switches have graphic symbols to indicate function and effect. The following mode descriptions start with the first switch on the left.

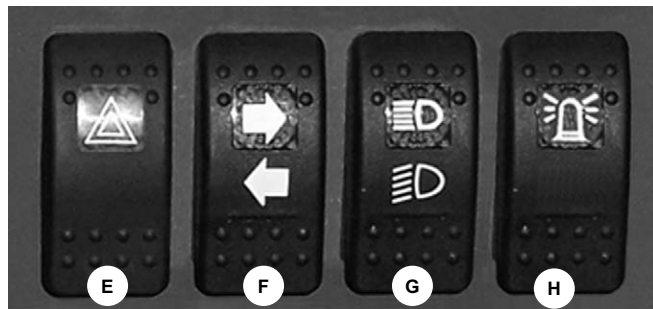

NOTE: *Some switches are optional and may not be on machine.*

E - Hazard: This switch can be activated to make the tail lights flash on and off in case the machine is stalled or temporarily stopped in a traffic area on the road or jobsite.

F - Turn Signal: This switch is used to indicate the direction of a turn with the tail lights. Press the right arrow for a right turn; press the left arrow for a left turn. Return the switch to the center position after the turn is completed.

G - Head Lights/Work Lights: Pressing the top of the switch will illuminate the lights mounted on the top of the operator's station and the red tail lights for forward travel operations. Pressing the bottom of the switch will illuminate the lights at the end of the boom in addition to the lights on the operator's station for additional lighting in working operations.

H - Strobe: When a beacon is installed on the machine, activating this switch will produce a strobe-light on and off flashing, for working in conditions that may obscure view of the machine.

Bottom Row Switches

Switches have graphic symbols to indicate function and effect. The following mode descriptions start with the first switch on the left.

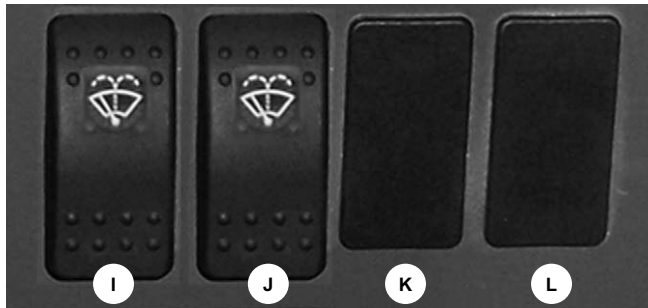

NOTE: Some switches are optional and may not be on machine.

I and J - Wiper/Washer: The windshield and top window of the operator's station are each equipped with a wiper and washer mechanism. The left switch (I) operates the wiper and washer on the windshield; the second switch (J) operates the wiper and washer on the top window.

K and L - Blank

Heater Controls

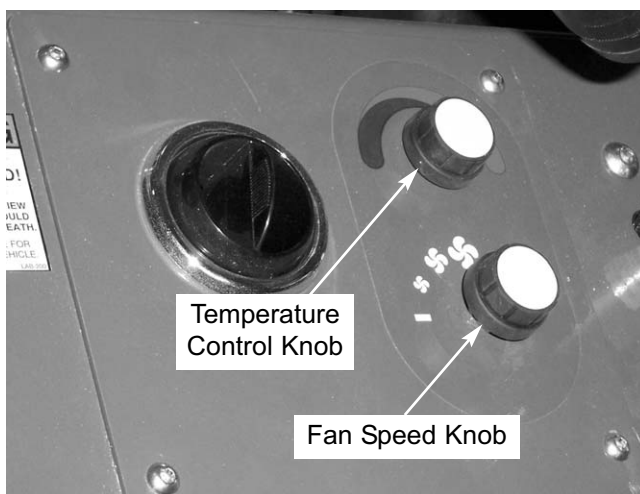

Temperature Control: This is the upper knob located to the left of the steering wheel. This knob is used to adjust the temperature output of the cab heater. Turning the knob clockwise will increase the temperature output.

Fan Speed: This knob is located below the temperature control knob. Rotating the knob clockwise will increase the fan speed for increased air circulation.

Heater A/C Controls

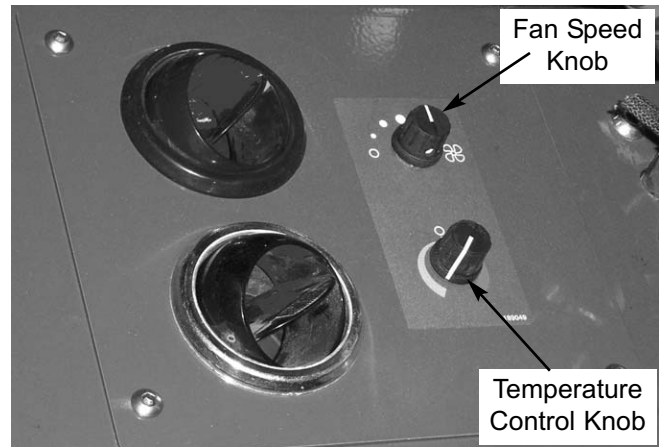

Fan Speed: This is the upper knob located to the left of the steering wheel. The fan is in the off position when the knob is rotated completely to the left. Rotating the knob clockwise will switch the fan on and increase the fan speed for increased air circulation.

Temperature Control: This knob is located below the fan speed knob. It is used to adjust the temperature output of the heater A/C unit. Turning the knob clockwise from the midpoint position will increase the temperature output of the cab heater. Turning the knob counter-clockwise from the midpoint position will switch the A/C unit on and decrease the temperature output of the cab A/C.

Travel Lever

Located on the left side of the steering wheel column, this lever is used to change travel direction (forward or reverse).

Position "F" (FORWARD)

Position "N" (NEUTRAL)

Position "R" (REVERSE)

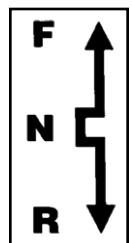

NOTE: The lever **MUST** be in N (Neutral) position before the starter will engage to start the engine.

IMPORTANT: Care should be taken when changing direction, because damage to the hydrostatic transmission can occur if shifting is forced or attempted at too high a speed. Allow machine

speed to slow before any directional change is attempted.

NOTE: Backup alarm automatically sounds with travel lever in reverse.

Steering

The power steering system is designed to provide low-effort steering without shock reaction from the axle wheels to the steering wheel. Turn the steering wheel to the right or left to turn the machine in that direction.

FLOOR AND SEAT AREA

Throttle Pedal: This is right-foot operated and controls the engine speed to match increased power requirements. Pushing down on the pedal increases the RPM; letting up on the pedal decreases RPM.

Service Brake Pedal and Transmission Cut-off: Pressing the brake pedal hydraulically activates the internal braking mechanism in the front axle. During initial brake pedal travel and as the brake pedal is pressed farther, power to the transmission is progressively cut off. This allows faster engine speeds at slower operating speeds while maintaining power to the hydraulic system.

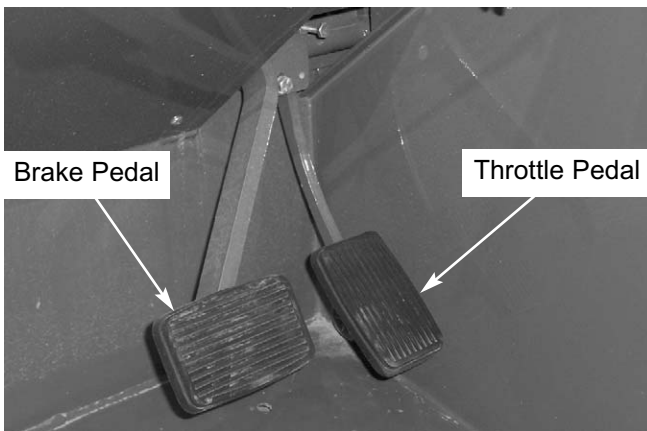

Brake Fluid Reservoir: Located in the front of the frame on the inside left wall under the cover.



Seat Positioning: The seat is mounted on rails for forward and rearward repositioning to accommodate the operator's size. A spring-loaded latch handle under the front of the seat activates the adjustment mechanism.

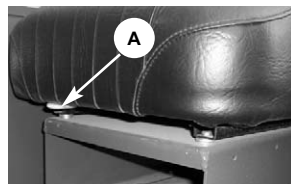

Suspension Seat (optional): In addition to the "A" latch handle for forward and rearward adjustment, this seat has a knob "B" under the front of the seat to adjust the suspension. Turn the knob to the right for a softer ride, and to the left for a firmer ride.

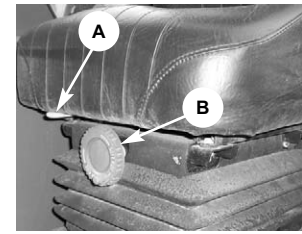

Seat Belt: This machine has a retractable seat belt. Grasp the belt on the left side of the seat pulling the belt over your lap and inserting the belt into the buckle on the right side of the seat until you hear it lock in place.

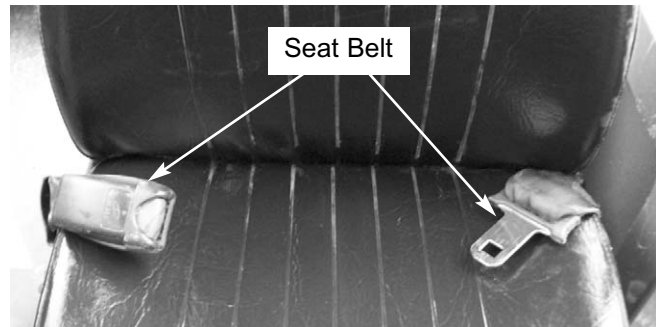

RIGHT SIDE PANEL

These controls are used to position the boom and attachment. Graphic symbols indicate the control actions.

Boom Control Joystick: This machine has a hydraulic-type telescopic boom. The boom section extends by means of a hydraulic cylinder inside the boom.

To extend the boom, move the joystick handle to the right; to retract the boom, move the joystick handle to the left. To raise the boom, move the joystick handle rearward; to lower the boom, move the joystick handle forward.

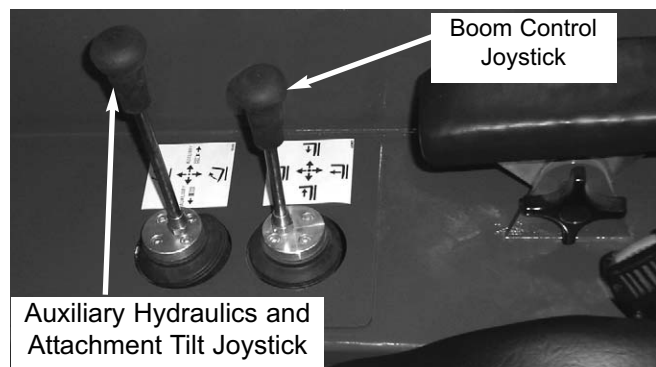

WARNING

Use extreme caution when raising or extending the boom. The Telescopic Handler **MUST** be within safe lifting parameters as indicated by the frame angle indicator. Loaded or empty, this machine can tip if not level.

ALWAYS place the transmission in neutral, set the parking brake and keep the service brake pedal fully depressed before raising or extending the boom.

NEVER exceed the specified lift and reach capacities of this machine. Serious machine damage or personal injury may result. Refer to the load charts in the operator's station or this manual.

If a boom circuit hose bursts with the boom up, with or without a load, shut down the machine following the Mandatory Safety Shutdown Procedure (page 8). **DO NOT** attempt repairs. Call your Gehl dealer for assistance.

Attachment Tilt/Auxiliary Hydraulics Joystick: To tilt the attachment tool up, move the joystick handle rearward; to tilt the attachment tool down, move the joystick handle forward. When the operator tilts the attachment tool to a desired angle, that angle will be maintained as the boom is raised and lowered, extended and retracted, until a new angle is set.

Move the joystick handle to the left or right to operate the additional hydraulics required on some attachment tools.

WARNING

The truss boom attachment tool should **ONLY** be used to lift and place loads when the machine is in a stationary position. Transporting suspended loads must **ALWAYS** be done slowly and cautiously, with the boom and load as low as possible. Use taglines to restrict loads from swinging, to avoid overturn.

DO NOT tilt the truss boom back more than 45° from horizontal. Check the frame angle indicator before raising a load.

FUNCTION INDICATORS

Frame Angle Indicator: Located in front of the operator on the ROPS upper cross tube, this indicator enables the operator to check if the Telescopic Handler is at a safe angle for operation.



Boom Angle Indicator: Mounted on the left side of the outer boom, the position of the ball shows the angle of boom elevation relative to the ground.

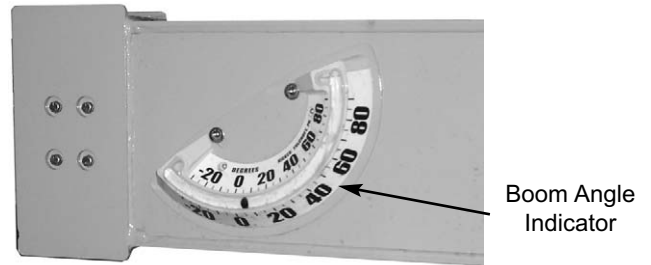

SERVICE AND SAFETY FEATURES

The following indicators are for checking fluid levels.

Engine Oil Level: The yellow dipstick is located on the top of the engine about centered above the valve cover.

Hydraulic Reservoir Oil Level and Fill Cap: The hydraulic oil level sight gauge is located under the engine cover directly below the battery compartment. The hydraulic oil fill cap is located under the engine cover toward the front, just to the left of the air cleaner.

Coolant Level: The coolant expansion tank is located under the engine cover forward of the radiator on the backwall.

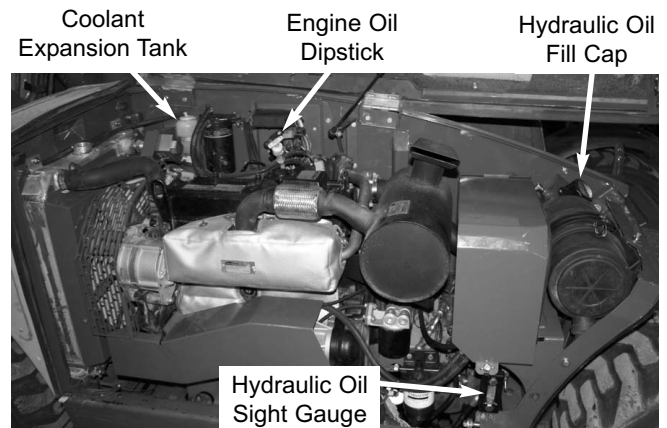

Hydraulic Restriction Indicator: This indicator is located on the multi-function display in the operator's compartment. (Refer to Checking and Changing Hydraulic Return Filter Element, page 51.)

Air Filter Restriction Indicator: This indicator is located on the multi-function display in the operator's compartment. (Refer to Checking and Changing Air Filter Element, page 52.)

Hydraulic Pressure Test Port: Located off the lower portion of the battery compartment; a gauge can be attached to this port to check main valve and steering pressures

Battery: The battery is located under the engine cover toward the front of the engine compartment directly to the rear of the air cleaner. Remove wing nut and cover to gain access to the battery.

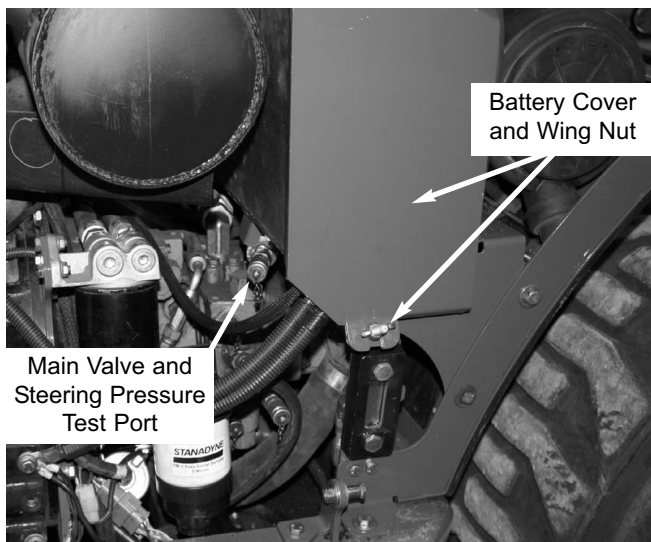

Backup Alarm: Located under the frame above the rear axle; it produces a loud warning sound whenever the machine is in reverse.

Right Side Rear View Mirror: Located on the right side of the machine; it provides the operator a view of the area on the right side and behind the machine.



Right Side Rear View Mirror

Left Side Rear View Mirror (optional): Located on the left side of the cab; it provides the operator a view of the area on the left side and behind the machine.



Left Side Rear View Mirror

Cab Right Side Window or Panel: Located on the right side of the cab; this window or panel protects the operator from coming in contact with the boom.

Cab Rear Window: Located on the rear of the cab; this window protects the operator from material flying off the rear wheel.

Front Window Emergency Exit: When equipped with the optional fully enclosed cab, the front window serves as an emergency exit. Pull the pin on each window hold-open, then push the window open and exit.

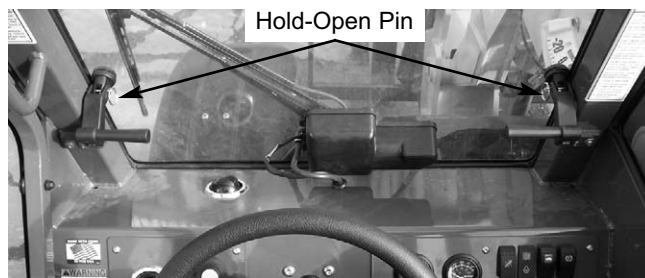

Operator Station Fuse and Relay Compartment: Located under the hinged load chart panel; lift the front of the panel to access the fuses and relays.



Operator Station Fuse and Relay Functions: Refer to the illustration and following description for the fuse and relay functions.

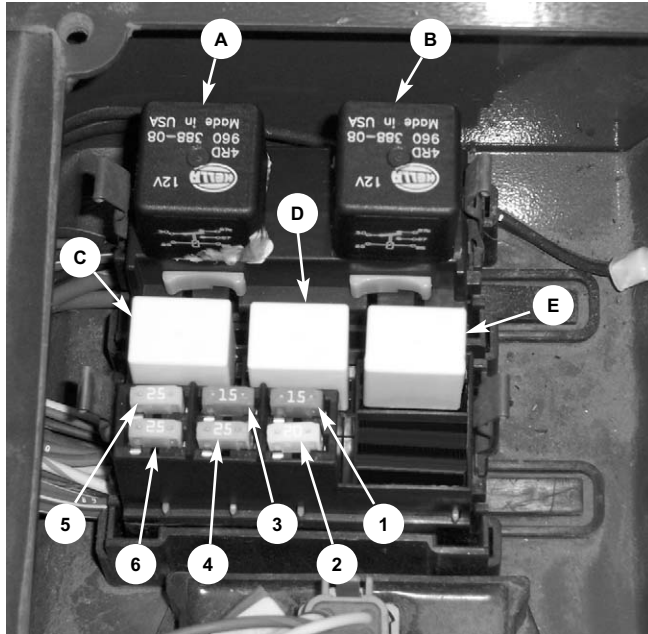

FUSES:

1. 15 AMP Fuse: ignition switch, horn, brake lights
2. 20 AMP Fuse: transmission, neutral start, park brake, steer mode, injector pump, backup alarm
3. 15 AMP Fuse: lights, turn signals, hi/low speed
4. 25 AMP Fuse: gauges, heater/hvac, alternator excitation
5. 25 AMP Fuse: top wiper motor
6. 25 AMP Fuse: front wiper motor

RELAYS:

- A. 40 AMP Change-over Relay: park brake
- B. 40 AMP Change-over Relay: ignition
- C. 20 AMP Relay: lights
- D. 20 AMP Relay: top wiper
- E. 20 AMP Relay: front wiper

Engine Compartment Fuses, Relays and Solenoids:
Located inside the engine compartment on the firewall.

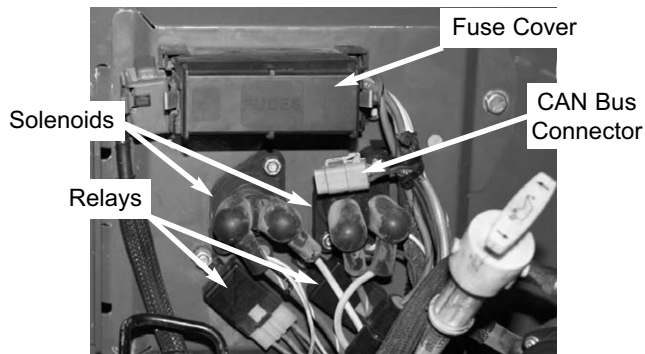

Engine Compartment Fuses and Relay Functions: Refer to the illustration and following description for the fuse and relay functions.

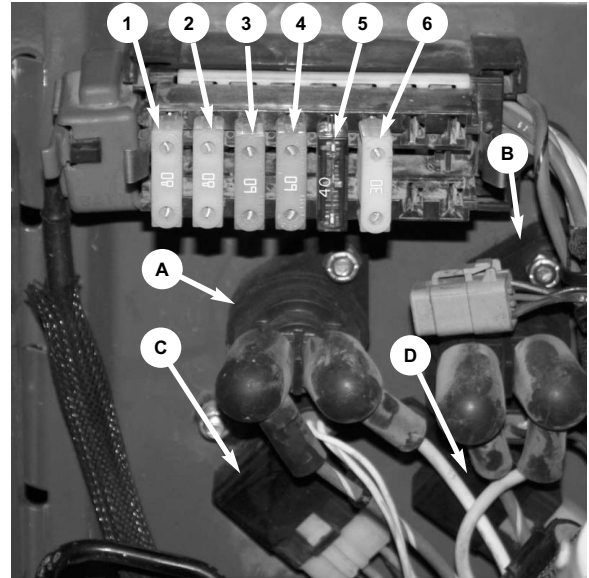

FUSES:

1. 80 AMP Fuse: Alternator
2. 80 AMP Fuse: Air Heater
3. 60 AMP Fuse: Chassis Power
4. 60 AMP Fuse: Starter
5. 40 AMP Fuse: A/C Evaporator (when equipped)
6. 30 AMP Fuse: A/C Condenser

SOLENOIDS:

- A. Sarter
- B. Air Heater

RELAYS:

- C. 20 AMP Relay: ECU
- D. 20 AMP Relay: Fuel Rack

ATTACHMENT TOOLS

Gehl offers a versatile range of attachment tools to meet various lifting and material handling applications. Contact your Gehl dealer for specifications and ordering information.

ACCESSORIES

Gehl offers a range of special accessories for this machine. Contact your Gehl dealer for specifications and ordering information.

NOTE: All accessories are field-installed unless otherwise noted. Information and parts for installing accessories are provided by the Gehl Company or Gehl Telescopic Handler dealers.

Chapter 6

OPERATION AND ADJUSTMENTS

GENERAL INFORMATION



BEFORE starting the engine and operating the Telescopic Handler, review and comply with ALL safety recommendations in the Safety chapter of this manual. Know how to STOP the machine before starting it. Also, BE SURE to fasten and properly adjust the seatbelt.

ENGINE BREAK-IN

A new engine does not require extensive “break-in.” However, for the first 100 hours of operation, follow these guidelines: Allow the engine to idle for a few minutes after every cold start. DO NOT idle the engine for long periods of time. DO NOT operate the engine at maximum power for long periods of time. Check the oil level frequently and replenish as necessary with the oil specified in the engine manual.

Yanmar engines do not use a “break-in” oil. After the first 50 hours of operation, change the oil and replace the oil filter. Consult the *Lubrication* chapter for the type and grade of oil to use. Refer to the *Service and Storage* chapter for the proper service intervals.

PRE-START INSPECTION

It is the operator’s responsibility to inspect the machine before the start of each workday. Every pre-start inspection must include more than checking the fuel and oil levels. It is a good practice to personally inspect any machine you are assigned to use, even though it has already been put into service by other personnel.

The most efficient method of checking a machine is by conducting a “Walk-Around Inspection.”

The following items should be included in the “Walk-Around Inspection:”

1. **Attachment Tool:** Check for broken missing or damaged parts. When utilizing forks, check for welds, cracks or misalignment. Replace the forks in sets when the condition of the fork(s) is questionable.

IMPORTANT: DO NOT use forks that have been repaired by welding.

2. **Attachment Tool Mount:** No loose or missing parts; no visible damage. Lock pins/plate in the locked position.
3. **Attachment Tool Mounting Pins:** No visible damage; pin fit is secure and properly lubricated.
4. **Boom Section and Wear Pads:** No loose or missing parts; no visible damage; no excessive wear.

NOTE: Wear pads that measure 3/8” (9.5 mm) thick or less need to be replaced.

5. **Boom Angle Indicator:** Looseness; no visible damage; bubble is visible.
6. **Tire and Wheel Assemblies:** Properly secured; no loose or missing lug nuts; no visible damage (cuts or abrasions); proper tire inflation.
7. **Tie Rod Linkage and Steering Knuckles:** No loose or missing parts; no visible damage; tie rod end studs locked; properly lubricated.
8. **Lift Cylinder:** Properly secured; no visible damage; no evidence of leaking from the cylinder; properly lubricated.
9. **Slave Cylinder:** Properly secured; no visible damage; no evidence of leaking from the cylinder; properly lubricated.
10. **Boom Pivot Assembly:** Properly secured; no visible damage or excessive wear; properly lubricated.
11. **Boom Hydraulic Hoses:** No visible damage or exterior wear; no evidence of leaking.
12. **Rear Light Assemblies (when equipped):** Properly secured; no visible damage; no loose or disconnected wires; function properly.
13. **Hydraulic Control Valve Assembly:** No loose or missing parts; not leaking; no damaged or leaking hoses.
14. **Covers, Doors and Latches:** All covers doors and latches are in working condition; properly secured with no loose or missing parts; all components operate properly.

15. **Exhaust System:** No loose or missing parts; no visible damage; no obstructions to the outlet.
16. **Hydraulic Cooler and Radiator:** No loose or missing parts; no visible damage; no evidence of leaking; cleanliness.
17. **Hydraulic Oil Reservoir:** No evidence of leaking; breather cap working and secure.
18. **Engine Oil Reservoir:** No evidence of leaking; dipstick fits securely.
19. **Battery Compartment:** No loose or broken cables; no damage or corrosion.
20. **Fuel Tank:** No damage or leaking; breather cap secure and working.
21. **Engine Air Cleaner:** No loose or missing parts; no obstructions to the inlet.
22. **Mirror Assembly:** No visible damage; adjusted properly.
23. **Attachment Tilt Cylinder:** Properly secured; no visible damage; no evidence of leaking from the cylinder; properly lubricated.
24. **Frame:** No cracks or visible damage.
25. **Tilt and Auxiliary Hydraulic Hoses:** No damage or excessive wear; no evidence of leaking.
26. **Frame Angle Indicator:** Looseness; no visible damage; bubble is visible.
27. **Operator Control Console:** Switches and levers undamaged; no loose or missing parts; load charts properly secured and legible; levers and switches operate properly; control decals are legible.

Along with performing the “Walk-Around Inspection”, the operator should perform the “10 Hour or Daily Service Checks” found in the *Service and Storage* chapter.

Before mounting the operator’s compartment, walk completely around the machine to be sure no one is under, on, or close to it. Let others in the area know you are going to start up and wait until everyone is clear of the machine.

BEFORE STARTING ENGINE

Before starting the engine and running the machine, refer to the *Indicators and Controls* chapter and become familiar with the various operating controls, indicators and safety features.

STARTING THE ENGINE

The following procedure is recommended for starting the engine:

1. Grasp the hand holds to step up into the operator’s compartment.
2. Adjust the seat and fasten the seat belt.



ALWAYS fasten your seat belt before starting the engine. Leave the parking brake applied until the engine is running and you are ready to operate the machine.

3. Check that all controls are in their “neutral” positions, except the parking brake switch, which should be in the “ON” position.



Do not use starting fluid (ether) with engine preheat systems. An explosion can result, which can cause engine damage, injury or death.

4. Turn the key switch to “ON” position. The pre-heat indicator on the multi-function display will be “ON” indicating the pre-heater is in use. When the indicator goes out, the engine can be started.

NOTE: *The engine pre-heater is used to assist starting in cold weather conditions. The indicator may stay lighted for 3-30 seconds depending on the temperature. If you are operating the telescopic handler in normal or warm weather conditions, the pre-heat indicator will go out in several seconds and you can start the engine.*

5. Press the start button. Release the button as soon as the engine starts. If the button is released before the engine starts, turn the keyswitch to “OFF” position and allow the starter to stop before attempting to start again.

IMPORTANT: *Crank the starter until the engine starts. If the engine fails to start within 15 seconds, return the key to the “OFF” position, wait at least 30 seconds, and try again to start the engine. Cranking the engine for longer than 15 seconds will result in premature failure of the starter.*

6. After the engine starts, allow a sufficient warm-up time before operating the controls.
7. Check that indicators are in normal condition.
8. Check that there are no fuel, oil or engine coolant leaks, and no abnormal noises or vibrations.

COLD STARTING

A optional block heater is recommended for starting in temperatures of 20°F (-7°C) or lower.

The block heater should be connected to an AC power supply several hours prior to starting the engine depending on the ambient temperature.

WARNING

Do not use starting fluid (ether) with engine preheat systems. An explosion can result, which can cause engine damage, injury or death.

If the battery becomes discharged and does not have sufficient power to start the engine, jumper cables can be used for starting assistance. Refer to the jump starting instructions in the *Service and Storage* chapter of this manual for safe jump starting procedures.

STOPPING

The following procedure is the recommended sequence for stopping the machine:

1. Bring the machine to a stop on a level surface. Avoid parking on a slope, but if necessary, park across the slope and block the tires.
2. Fully retract the boom and lower the attachment to the ground. Idle the engine for gradual cooling.
3. Place controls in neutral. Apply the parking brake.
4. Turn the ignition switch key to the “OFF” position. Remove the key.
5. Unfasten the seatbelt, and grasp the hand holds while climbing out of the operator’s compartment.

FIRST TIME OPERATION

CAUTION

Be sure the area used for test-running is clear of spectators and obstructions. Initially, operate the machine with an empty attachment tool.

Make sure the engine is warm and then go through the following procedures:

Select the travel direction. Switch off the parking brake and move ahead slowly, while testing the steering and brakes. Stop and operate all boom and attachment tool function controls, checking for smooth response.

Apply the service brakes, stop the machine and move the travel lever to the opposite direction.

IMPORTANT: *To prevent damage to the transmission, the Telescopic Handler should be traveling at a slow speed and not accelerating when changing the direction of travel.*

PARKING BRAKE

NOTE: *The parking brake mechanism within the front axle is NOT designed for, OR intended to be used as, the primary means of stopping movement of the machine. Hydraulic braking provided through the service brakes within the axles is the primary means for stopping movement. The axle-by-axle split brake system is the secondary means of stopping movement.*

The proper sequence for correct machine operation is to always engage the parking brake switch before shutting off the engine; and to disengage the parking brake ONLY after the engine is running. In an EMERGENCY, if it becomes necessary to stop the machine, activate the parking brake switch to “ON.”

CHANGING ATTACHMENT TOOLS

The Telescopic Handler boom nose will accept Gehl Quick-attach System attachment tools. The Quick-attach System has a quick-release hookup and locking mechanism for mounting framing-type or masonry-type attachment tools to the boom nose.

Attaching

To pick up the attachment tool, proceed as follows:

1. Raise the boom slightly, extend it 2 to 3 feet (600-900 mm) for better visibility, and tilt the Quick-attach System forward.
2. Align the Quick-attach System squarely with the back of the attachment tool.
3. Slowly extend the Quick-attach System and lower the hooks under the attachment tool hookup bar.
4. Tilt the Quick-attach System back so that the lock plate engages the attachment tool. This secures the attachment tool to the Quick-attach System.

- For an attachment tool with auxiliary hydraulics, connect hoses to the quick-disconnect connectors on the boom nose.

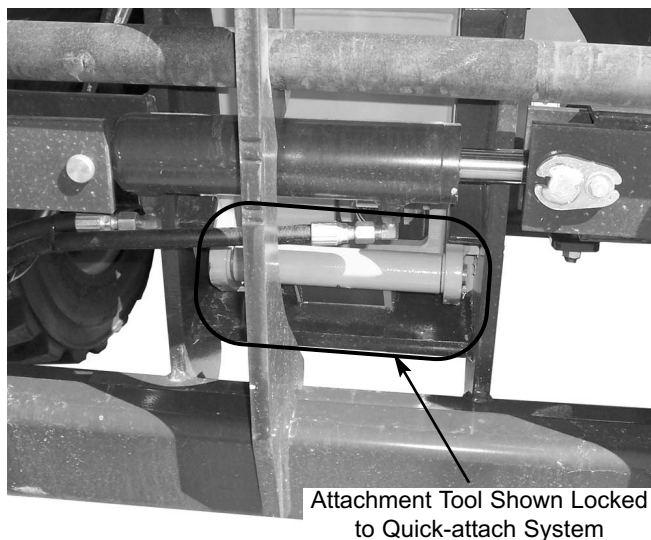
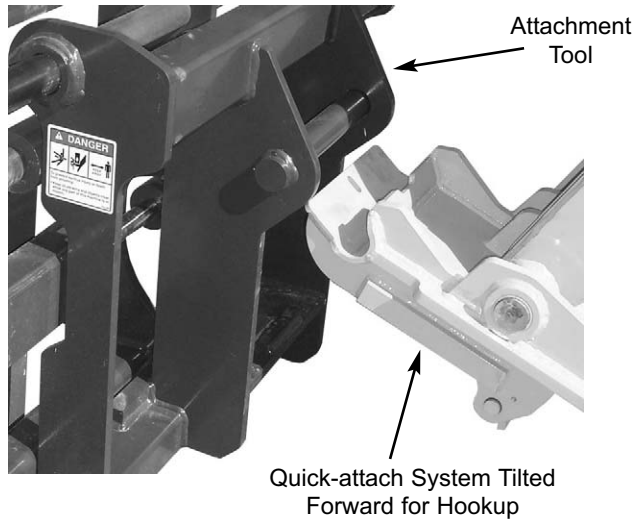

Quick-attach System Attaching Detail

Detaching

To detach attachment tool, proceed as follows:

- Raise the boom slightly and extend it 2 to 3 feet (600-900 mm) for better visibility. Lower the boom until the attachment tool is approximately 12" (300 mm) off the ground.
- Roll the carrier rearward as far as it will go. When the carrier is rolled all the way back, perform the Mandatory Safety Shutdown Procedure (p. 8, Safety chapter).
- With the engine off, leave the operator's station. Manually raise the lock spring, and flip the lock plate up and outward at least 180° so it is in position to re-lock on the next attachment tool.

- Tilt the Quick-attach System forward to allow the attachment tool to roll out, then lower the boom so the hook ears clear the hookup bar on the attachment tool.

NOTE: One side of the lock plate has a bright red decal to indicate the unlocked position.

- If the attachment tool has auxiliary hydraulics, disconnect the hoses from the quick-disconnects on the boom nose.
- Start the engine and tilt the Quick-attach System forward, then slowly back the machine until the attachment tool is free from the boom nose.

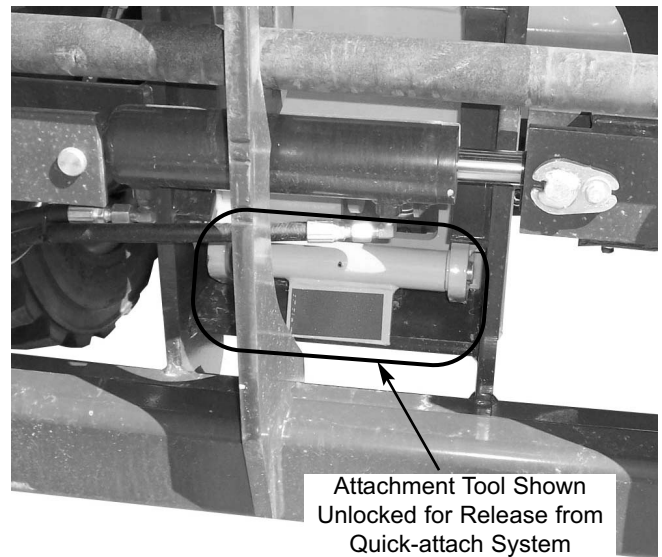

Quick-attach System Detaching Detail

WARNING

Modifications, alterations to, or use of attachment tools not authorized by Gehl (or the manufacturer) in writing can void warranty and cause machine damage and/or serious personal injury or death.

SELF-LEVELING

The machine is equipped with a hydraulic self-leveling feature. This feature is designed to keep the attachment tool level while the boom is being raised and lowered.

GENERAL MACHINE OPERATION

Check the Telescopic Handler to be sure all systems are in good operating condition. Perform the following steps before starting the machine the first time each day:

1. Check the engine oil, coolant and hydraulic oil levels.
2. Check hydraulic oil cooler and engine radiator for debris.
3. Be sure weekly lubrication has been done.
4. Visually inspect for leaks and broken or malfunctioning parts. Be sure all caps, covers and safety shields are in place.
5. Check tires for cuts, bulges, nails, correct pressure, loose wheel nuts, etc.
6. Inspect the work area. Be sure you know where you will make load pickups, lifts and turns. Look over the terrain of the jobsite for holes, obstacles, slippery surfaces, and soft or deep mud.
7. Check clearances of ramps, doorways and passage-ways. Check overhead clearances if you will travel and place loads near power or telephone lines.



Exhaust fumes can kill. Ensure proper ventilation when starting indoors or in enclosed areas.

Use proper hand holds, NOT the steering wheel or control levers when mounting and dismounting.

NEVER operate the machine with safety guards or covers removed.

Over-inflated tires can explode and cause injury or death. Tire repairs MUST be made only by authorized personnel using proper tools and equipment.

If the machine is in need of repair or in any way unsafe, or contributes to an unsafe condition, the matter must be reported immediately to the user's designated authority. The machine must NOT be operated until it has been restored to a safe operating condition.

Operate the travel controls gradually and smoothly when starting, stopping, turning and reversing direction.

Grade and Slope Precautions

The Telescopic Handler complies with industry stability test requirements and is stable when properly operated. However, improper operation, faulty maintenance,

and poor housekeeping can contribute to a condition of instability and defeat the purpose of the standard.

The amount of forward and rearward tilt to be used is governed by the application. Although use of maximum rearward tilt is allowable under certain conditions, such as traveling with the load fully lowered, the stability limits of the machine, as determined by the industry standard tests, do not encompass consideration for excessive tilt at high elevations, or the handling of off-center loads.

Only handle loads within the capacity limits of the machine, and which are stable and safely arranged. When attachments are used, extra care should be taken in securing, manipulating, positioning and transporting the load.

Grade Limits

NOTE: *Grade limits are based on ANSI/ITSDF standard B56.6-2005.*

This Telescopic Handler meets or exceeds the safety standard (ANSI/ITSDF B56.6) stability limits for rough terrain forklifts. The stability tipping limits cover specific, controlled test conditions, which are extremes, and which are not intended to be achieved during normal worksite operations. The following specifications are provided only as information to the operator, and must not be used as a guideline for operating the Telescopic Handler. For safe operation, always follow the instructions and warnings provided in this manual.

1. DO NOT place or retrieve loads on an up or down slope or grade that exceeds 7% or 4°.
2. DO NOT travel up or down a grade or slope that exceeds 22% or 12° while loaded.
3. DO NOT place or retrieve loads on a side hill with a slope or grade that exceeds 12% or 7°. Check the location of the ball in the frame angle indicator located on the ROPS/FOPS cross member. If the ball in the frame angle indicator is in the green zone, it is safe to place or retrieve the load. If the ball in the frame angle indicator is in the yellow zone, use slower movements and extra caution to ensure remaining within the limits of the load chart, because the machine is nearing an unstable condition. If the ball in the frame angle indicator is in the red zone, loads cannot be placed or retrieved.

- DO NOT travel across a side hill that exceeds 18% or 10° grade. Check the frame angle indicator on the ROPS/FOPS cross member to determine the angle of the grade. The attachment tool MUST be maintained at the “carry” position, with the boom fully retracted and attachment tool at minimum ground clearance.

When ascending or descending grades in excess of 5% or 3°, the machine should be driven with the load upgrade. An unloaded machine should be operated on all grades with the load handling attachment tool downgrade, tilted back if applicable, and raised only as far as necessary to clear the ground surface.

Avoid turning if possible and use extreme caution on grades, ramps and inclines. Normally travel straight up and down the slope.

Traffic Flow Patterns

Know and understand the traffic flow patterns of your jobsite. Know all Telescopic Handler hand signals for safety. Use signal persons as necessary for safe operation, and be sure you can see the signal person and acknowledge the signals given.

Safety Hand Signals

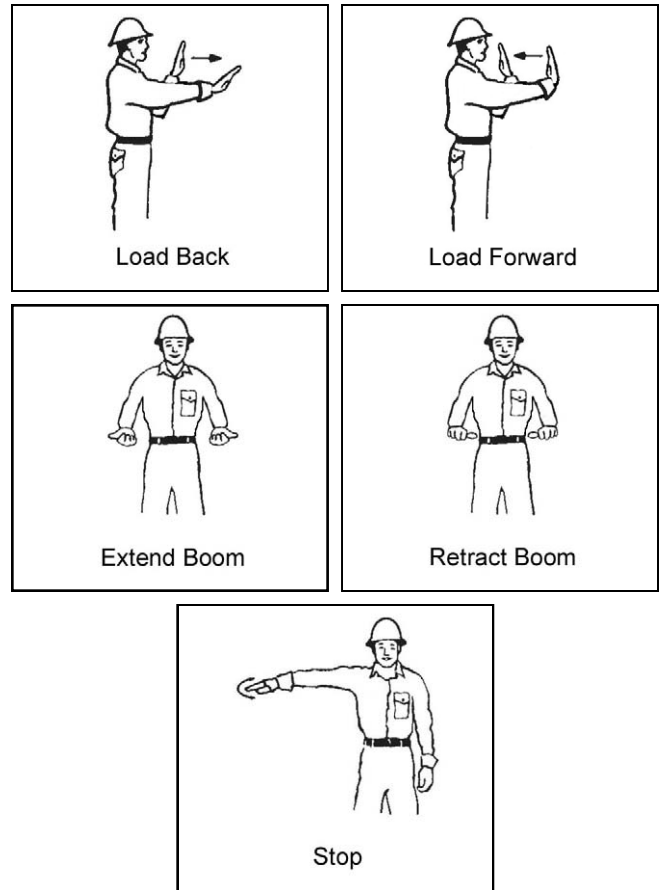
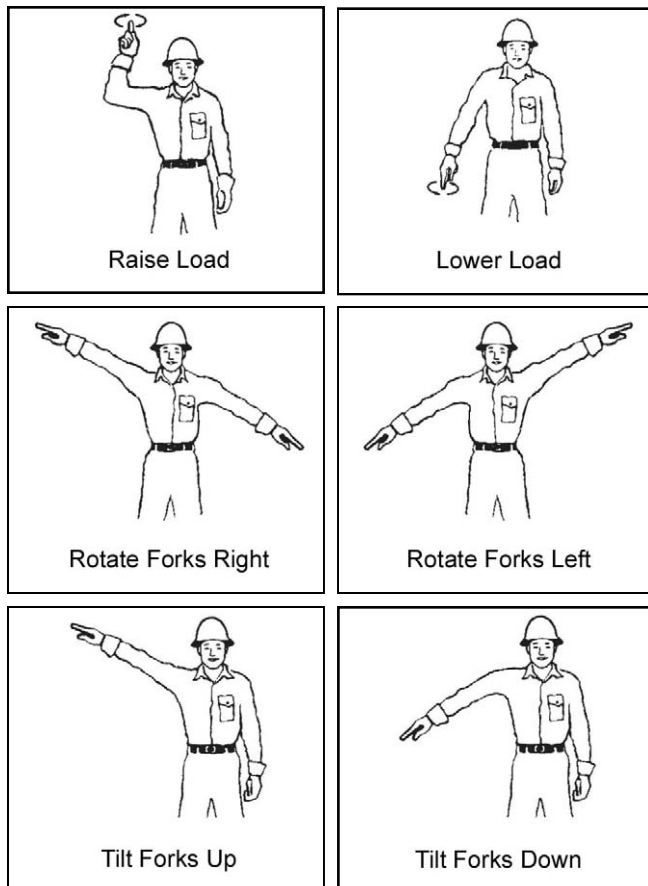

When ramps must be used in transporting loads with the machine, the following are the minimum widths for safe travel:

Compacted dirt, gravel, etc.	12 ft. (3.6 m)
Woodboard, concrete, etc.	10 ft. (3.0 m)

Permanent aisles, roadways and passageways, floors and ramps must be clearly defined or marked. Permanent or temporary protrusion of loads, equipment, material and construction facilities into the usual operating area must be guarded, clearly and distinctively marked, or clearly visible.

Maintain a safe distance from the edge of ramps, platforms and other similar working surfaces.

Controlled lighting of adequate intensity should be provided in operating areas. Where operating conditions indicate, the operator/user is responsible for having the machine equipped with lights.

Provisions must be made to prevent trucks, semi-trailers and railroad cars from being moved during loading and unloading.

Wheel stops, parking brakes, or other positive holding means must be used to prevent movement during loading and unloading.

DO NOT move railroad cars and trailers with the Telescopic Handler.

DO NOT use the boom and attachment for leverage to push the machine out of mud.

IMPORTANT: *DO NOT lower boom at high engine speed when attachment tool is at maximum rearward tilt, because damage to slave cylinders may result.*

GENERAL LOAD HANDLING

NEVER attempt to work controls except from the operator's seat. NEVER jerk or use fast movements. Avoid sudden stops, starts and changes in direction.

Operation of the hydraulic system depends on engine speed and the distance the controls are moved. When operating these controls it is important to develop a technique called "feathering." Feathering the control means starting the desired motion by moving the control a small amount away from neutral. Then after movement has started, the control can be eased to full movement. Use the same feathering technique to stop the motion.

WARNING

Excessive speed can be hazardous. ALWAYS exercise caution and good judgement while operating the machine.

ALWAYS maintain a safe distance from electric power lines and avoid contact with any electrically charged conductor and gas line. It is not necessary to make direct contact with a power line for power to ground through the structure of the machine. Keep the boom and load at least 10 ft. (3 m) from all power lines. Accidental contact or rupture can result in electrocution or an explosion. Contact the North American One-Call Referral System at (888) 258-0808 for the local "Digger's Hotline" number or proper local authorities for utility line locations BEFORE starting to dig!

Keep all body parts inside the operator's station while operating the machine. BE SURE of clearance for the attachment tool when turning, working around buildings, etc.

Turning corners too fast can tip the machine, or cause a load to tip off the attachment. Sudden slowing or stopping of the machine may cause the load to drop off the attachment tool.

Be certain you can control both speed and direction before moving. Always place the machine in neutral and set the parking brake before raising or extending the boom. NEVER drive the machine up to someone standing in front of the load.

NEVER leave the operator's station without first lowering the attachment tool to the ground. Then set the parking brake, place controls in neutral, shut off engine and remove the key. AVOID parking the machine on a slope, but if necessary, park across the slope and block the tires.

Load Capacity and Reach

This machine has flip-charts in the operator's station that provide the load capacity limits at various positions of attachment tool extension and elevation. A set of the load zone charts is reproduced at the end of this manual for reference.

A typical load zone chart is shown on the next page. The scale on the left indicates height in feet above the ground level. The scale on the bottom shows the distance in feet out from the front of the machine. The arc lines noted by the numbers "1" through "4" correspond to the position extension markers on the operator side of the inner boom section.

The following example illustrates proper use of the load zone charts for the Telescopic Handler:

WARNING

NEVER exceed the rated operating capacity of the Telescopic Handler as shown on the load zone charts.

Example:

The operator, using a standard carriage attachment tool, wants to raise a 4000 pound load 10 feet high, and can only get to within 5 feet of the load placement point. Can it be done within the capacity of the machine?

Analysis: See “Typical Load Zone Chart” below.

Projecting up from the 5-foot mark on the horizontal axis to intersect a line through the 10-foot mark on the vertical axis shows the load can be placed in the 4000 pound zone.

During placement, the operator observes when the extension reference number “2” on the boom becomes visible and stops. The maximum safe distance of extension with this load has been reached.

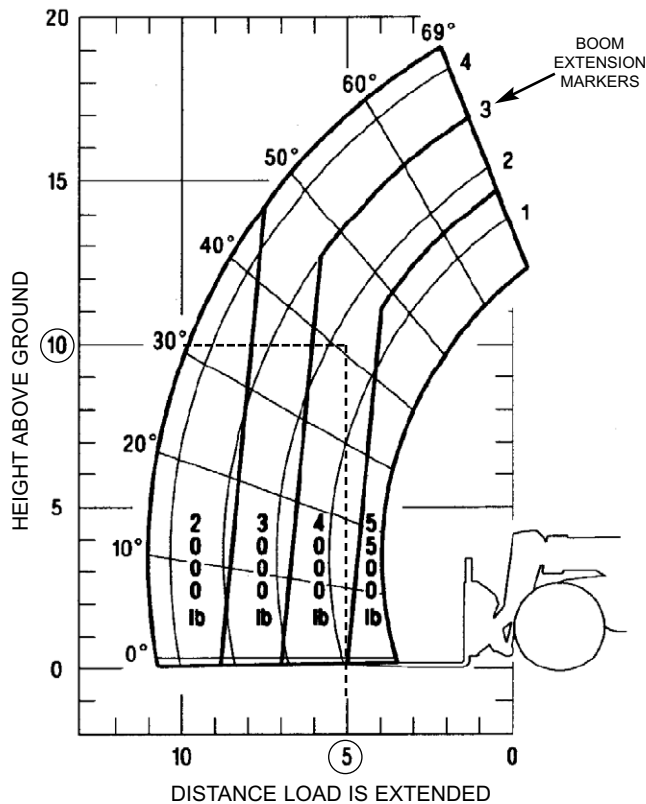

Typical Load Zone Chart

LIFTING ATTACHMENT TOOL APPLICATIONS

Picking Up the Load

Inspect the load. If it appears unstable, DO NOT attempt to move it. DO NOT attempt lifting double-tiered loads, or straddling side-by-side pallets with one on each fork. NEVER add extra unauthorized counterweights to this machine.

WARNING

Operating conditions can reduce the machine’s safe operating capacity. Exceeding the capacity when raising or extending the boom will cause the machine to tip forward.

Approach the load squarely and slowly with the machine straight and level. Adjust the space between forks, if necessary. Engage the load equally on both forks until the load touches the carriage backrest. Tilt the forks back to position the load for travel.

Carrying the Load

If the load obstructs your view, get someone to direct you. Maintain ground speeds consistent with ground conditions and which permit stopping in a safe manner.

WARNING

NEVER travel with the boom above the carry position (attachment tool should be at minimum ground clearance). Boom should be fully retracted.

NEVER coast with the transmission in neutral. Travel up and down grades slowly.

DO NOT operate the machine on a slope or grade that exceeds 22% or 12°.

Elevating and Placing the Load

For ground level load placement, be sure the area under the load and around the machine is clear of equipment and personnel. Lower the load to the ground, tilt the forks to the horizontal position, and then carefully back away to disengage forks from the load.

For elevated or overhead placement, bring the machine as close as possible to the landing point, and then:

WARNING

DO NOT raise the boom until you check the frame angle indicator to verify that the ball is in a safe zone for raising and placing a high load.

1. Use extreme caution for high placement. Be sure personnel are clear of the area where the load or the machine could tip or fall.



WARNING

Be sure that the surrounding ground has adequate strength to support the weight of the machine and the load it is carrying.

Always wear the seat belt provided to prevent being thrown from the machine. If you are in an overturn:

- DO NOT jump!
- Hold on tight and stay with the machine!
- Lean away from the fall!

-
2. Set the parking brake, hold the service brake pedal in fully applied position and slowly raise the load, maintaining a slight rearward tilt to cradle the load.
 3. As the load approaches the desired height, feather the boom control at minimum speed until the load is slightly higher than the landing point.
 4. Continue the feathering technique and lower the load into place.
 5. Free the forks from the load by alternately retracting and raising the boom. If this process is not possible, very slowly and carefully reverse the telescopic handler to free the forks from the load.
 6. Lower the forks to travel height.



WARNING

The machine becomes less stable as the load is raised higher.

Before raising a load, be sure the Telescopic Handler is within the safe lifting parameter as indicated by the frame angle indicator.

If a hydraulic boom circuit hose should break with the boom up, shut down the machine. DO NOT attempt to bring down the boom or make repairs. Call your Gehl dealer immediately.

As lift height increases, depth perception decreases. High elevation placement may require a signal person to guide the operator.

DO NOT ram the lift cylinder to the end of the stroke. The resulting jolt could spill the load.

A jib or truss boom should **ONLY** be used to lift and place loads when the machine is stationary and the frame is level. Transporting suspended loads must **ALWAYS** be done slowly and cautiously, with the boom and load as low as possible. Use taglines to restrict loads from swinging, to avoid overturns.

SUSPENDED LOADS

The handling of suspended loads by means of a truss boom or other similar device can introduce dynamic forces affecting the stability of the machine that are not considered in the stability criteria of industry test standards. Grades and sudden starts, stops and turns can cause the load to swing and create a hazard.

Guidelines for “Free Rigging / Suspended Loads”

1. DO NOT exceed the rated capacity of the telescopic handler as equipped for handling suspended loads. The weight of the rigging must be included as part of the load.
2. During transport, the length of the rigging between the attachment and load should be as short as possible to reduce booms height and movement. DO NOT raise the load more than 12 inches (305 mm) above the ground, or raise the boom more than 45 degrees.
3. Only lift the load vertically – NEVER drag it horizontally.
4. Use multiple pickup points on the load when possible. Use taglines to restrain the load from swinging and rotating.
5. Start, travel, turn and stop SLOWLY to prevent the load from swinging. DO NOT exceed walking speed.
6. Inspect rigging before use. Rigging must be in good condition and in the U.S. comply with OSHA regulation §1910.184, “Slings,” or §1926.251, “Rigging equipment for material handling.”
7. Rigging equipment attached to the forks must be secured such that it cannot move either sideways or fore and aft. The load center must not exceed 24 inches (610 mm).

8. DO NOT lift the load with anyone on the load, rigging or lift equipment, and NEVER lift the load over personnel.
9. Beware of the wind, which can cause suspended loads to swing, even with taglines.
10. DO NOT attempt to use frame-leveling to compensate for load swing.

ROAD TRAVEL

For short distance highway travel, attach a Slow-Moving Vehicle (SMV) emblem (purchased locally) to the rear of the Telescopic Handler. For highway operation, obtain and install an amber flashing beacon.

NOTE: ALWAYS follow ALL state and local regulations regarding the operation of equipment on or across public highways. Whenever there is an appreciable distance between jobsites, or if driving on public highway is prohibited, transport the machine using a vehicle of appropriate size and capacity.

TRANSPORTING BETWEEN JOBSITES

ALWAYS abide by the following recommended procedures and guidelines when using ramps to load the machine onto (and unload it from) a truck or trailer. Failure to heed can result in damage to equipment and serious personal injury or death!

Tie-down points are provided for inserting chains to secure the machine during transport.



Front Tie Down



Rear Tie Down

Loading Machine Using Ramps

NOTE: A matched pair of ramps is required.

1. The ramps MUST be of sufficient strength to support the machine. Whenever possible, the use of strong steel ramps is recommended as well as center supporting blocks.
2. The ramps MUST be firmly attached to the truck or trailer bed with NO step between the bed and the ramps.

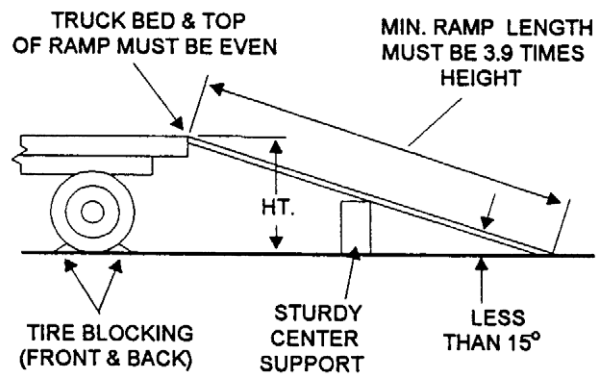

Ramp Placement

3. Incline of ramps MUST be less than 15 degrees. Ramp length MUST be at least 16 feet (4.9 m) long.
4. Ramp width MUST be at least 1-1/2 times the tire width.
5. Block the front and rear of the tires on the truck or trailer; engage the parking brake.
6. Position the machine with the boom facing toward the front of the truck or trailer so that it is straight in line with the ramps. Slowly (at the lowest engine speed possible) and carefully drive the machine up the ramps.
7. Tie-down points are provided at the front and rear corners of the frame structure.

WARNING

NEVER adjust travel direction (even slightly) while on the ramps. Instead, back off the ramps, and then realign the machine with the ramps.

WARNING

NEVER transport the machine with the boom raised or extended. **BE SURE** to secure the machine (including boom) to the truck or trailer bed using chain and binders or steel cables, to prevent any movement while transporting.

Unloading Machine Using Ramps

NOTE: A matched pair of ramps is required.

Repeat Steps 1 through 5 and proceed as follows to unload the machine:

6. Remove the tie-down chains/cables.
7. If necessary, adjust the machine so that the wheels are in line and centered with the ramps.
8. Slowly (at the lowest engine speed possible) and carefully drive the machine down the ramps.

LIFTING THE TELESCOPIC HANDLER



Front Lift Point



Rear Lift Point

The Telescopic Handler can be lifted using the four lifting points shown above.

Lift equipment used and its installation is the responsibility of the party conducting the lift. All rigging must comply with applicable regulations and guidelines.

WARNING

Before lifting, check the lifting equipment for proper installation.

- Never allow riders in the operator's station while the telescopic handler is lifted.
- Keep everyone a safe distance away from the telescopic handler while it is lifted.
- The telescopic handler may only be lifted without a load on the forks, or without an attachment. Never lift the telescopic handler with attachment other than those stated.

1. Using suitable lift equipment, hook into the lift eyes. Adjust the length of the slings or chains to lift the telescopic handler level.

IMPORTANT: As needed, use a spreader bar to prevent the slings or chains from rubbing the sides of the boom.

2. Center the hoist over the Telescopic Handler. To prevent shock loading of the equipment and excessive swinging of the load, slowly lift the Telescopic Handler off the ground. Perform all movements slowly and gradually. As needed, use a tag line to help position the Telescopic Handler.

TOWING THE TELESCOPIC HANDLER

WARNING

Do not tow the Telescopic Handler at more than 3 mph (5 km/h), and only for short distances (less than 100 yards).

If the machine becomes disabled, it can be towed for a short distance. To tow the Telescopic Handler, the high pressure limiters on the hydrostatic transmission must be unlocked and the SAHR parking brake must be released.

Hydrostatic Transmission Unlocking Procedure

1. Remove the plastic caps on the high pressure limiters.

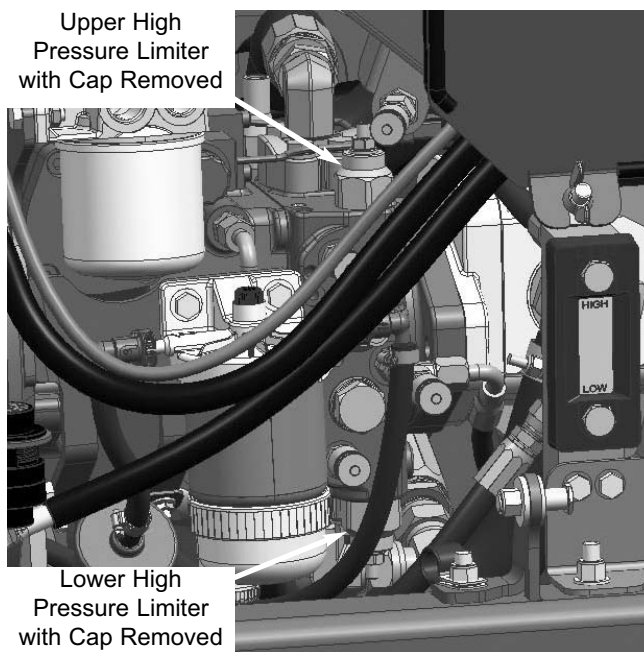

2. Loosen the jam nut on a high pressure limiter.

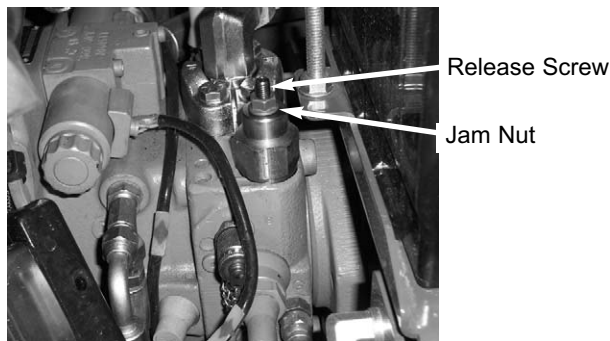

3. While holding the jam nut, use an Allen wrench to turn the center release screw in until it bottoms.
4. Tighten the jam nut.
5. Repeat steps 2-4 for the other high pressure limiter.

SAHR Parking Brake Releasing Procedure

1. There are unlocking screws on the front and rear sides of the axle. Locate and loosen both unlocking screws (1) and remove the stop washers (3).

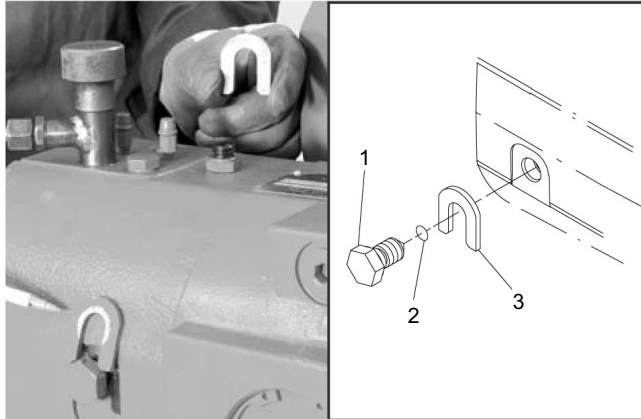

2. Turn the unlocking screws (1) fully in.

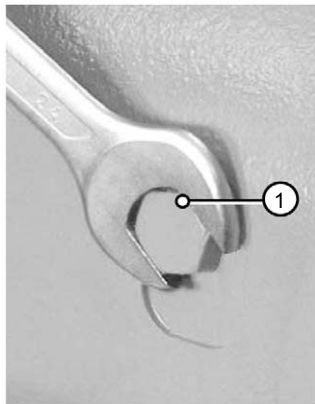

The Telescopic Handler can now be towed.

WARNING

Before the Telescopic Handler can be returned to service, the SAHR parking brake must be returned to the applied position, and the hydrostatic transmission high pressure limiters must be locked.

SAHR Parking Brake Applying Procedure

1. Loosen the unlocking screws (1) and re-install the stop washers (3).
2. Tighten the unlocking screws against the stop washers.

Hydrostatic Transmission Locking Procedure

1. Loosen the jam nut on a high pressure limiter.
2. Using an Allen wrench, turn the center release screw back out until it stops.
3. Tighten the jam nut.
4. Repeat steps 1-3 for the other high pressure limiter.

THEFT DETERRENENTS

Gehl has recorded all major component part numbers and serial numbers. Users should take as many of the following actions as possible to discourage theft, to aid in the recovery in the event the machine is stolen, and to reduce vandalism:

1. Remove keys from unattended machines.
2. Attach, secure, and lock all anti-vandalism and anti-theft devices on the machine.
3. Lock doors of cabs when not in use.
4. Inspect the gates and fences of the equipment storage yard. If possible, keep machines in well-lighted areas. Ask the local law enforcement agency to make frequent checks around the storage and work sites, especially at night, during weekends, and on holidays.
5. Report any theft to your dealer and insurance company. Provide the model and all serial numbers. Request your dealer to forward this information to Gehl Company.

INTENTIONALLY BLANK

Chapter 7

LUBRICATION

GENERAL INFORMATION

WARNING

NEVER lubricate or service this unit when any part of the machine is in motion. ALWAYS exercise the Mandatory Safety Shutdown Procedure (p. 8 Safety chapter) before lubricating or servicing this equipment.

NOTE: *The Maintenance chapter in this manual has provisions for recording the dates and hourmeter readings after lubrication or other service has been performed; use those spaces to keep a log for maintaining a current service interval record. Proper routine lubrication is an important factor in preventing excessive part wear and early failure.*

LUBRICANTS







The chart on this page lists the locations, temperature ranges and recommended types of lubricants to be used when servicing this machine. Also refer to the separate engine manual for additional information regarding recommended engine lubricants, quantities required and grades.

SEVERE OPERATING CONDITIONS

If the machine is to be operated uninterrupted at full travel speed over distances greater than five miles at ambient temperatures exceeding 90°F (32°C), then the recommended hydraulic oil shown in the chart to the right should be replaced with oil that has an ISO Viscosity Grade (VG) of 68, SAE 20, or equivalent.

In these severe operating conditions, the drive motor generates more heat and this hydraulic oil will provide the hydrostatic drive components the lubrication needed for proper operation.

NOTE: *Refer to “Operator Services” in the Service and Storage chapter of this manual for detailed information regarding periodic checking and replenishing of lubricants.*

<p>Hydraulic System Reservoir </p> <p>Use Mobil DTE 15M, or an equivalent that contains anti-rust, anti-foam and anti-oxidation additives and conforms to ISO VG46. Refer to “Severe Operating Conditions” on this page for additional hydraulic oil specifications. Capacity: 18 gallons (68 L)</p>																																	
<p>All Grease Fittings </p> <p>Use No. 2 Lithium-based Grease</p>																																	
<p>Engine Crankcase Oil </p>																																	
<table border="1"> <thead> <tr> <th>-4° -20°</th> <th>14° -10°</th> <th>32°F 0°C</th> <th>50° 10°</th> <th>68° 20°</th> <th>86° 30°</th> <th>104° 40°</th> <th>122° 50°</th> </tr> </thead> <tbody> <tr> <td colspan="2">← SAE 10W →</td> <td colspan="2">← SAE 20W →</td> <td colspan="4">← SAE 10W-30 →</td> </tr> <tr> <td colspan="4">← SAE 15W-40 →</td> <td colspan="2">← SAE 20W →</td> <td colspan="2">← SAE 30W →</td> </tr> <tr> <td colspan="6">← SAE 20W-50 →</td> <td colspan="2">← SAE 40W →</td> </tr> </tbody> </table>		-4° -20°	14° -10°	32°F 0°C	50° 10°	68° 20°	86° 30°	104° 40°	122° 50°	← SAE 10W →		← SAE 20W →		← SAE 10W-30 →				← SAE 15W-40 →				← SAE 20W →		← SAE 30W →		← SAE 20W-50 →						← SAE 40W →	
-4° -20°	14° -10°	32°F 0°C	50° 10°	68° 20°	86° 30°	104° 40°	122° 50°																										
← SAE 10W →		← SAE 20W →		← SAE 10W-30 →																													
← SAE 15W-40 →				← SAE 20W →		← SAE 30W →																											
← SAE 20W-50 →						← SAE 40W →																											
<p>*API Service Classification: CD, CF, CF-4, CI-4 Change volume w/ filter: 11.1 quarts (10.5 L)</p>																																	
<p>Diesel Fuel </p> <p>IMPORTANT: Use diesel fuel with a sulfur content of 500 PPM or less. Fuel specified to EN590:96 or ASTM D975-94 is strongly recommended. Fuel additives are not recommended. Refer to the engine manual for additional information.</p>																																	
<p>Axle Gear Oil </p> <p>MobilFluid® 424 (recommended) API GL5 85W-90 with Wet Brake Additive (Wet Brake Additive part number L71456) Front Differential Capacity: 4.0 quarts (3.8 L) Rear Differential Capacity: 4.0 quarts (3.8 L) Transfer Case Capacity: Front axle: 8 oz. (0.23 L) Front Planetary Capacity: 27 oz. (0.8 L) Rear Planetary Capacity: 30 oz. (0.9 L)</p>																																	
<p>Brake System </p> <p>Use Sunco Multi-ATF or equivalent</p>																																	

FILTER REFERENCE CHART	
TYPE	PART NUMBER
Engine Oil Filter	195568
Engine Fuel Filter	193024
Water Separator Filter	245005
Air Filter	Primary 104047
	Secondary 104046
Hydraulic Return Filter	074830
Cab Ventilation Filter	211146

IMPORTANT

To ensure continued proper operation, use only genuine Gehl replacement filters.

GREASING

Refer to the illustrations and listings for fitting locations. Wipe dirt from the fittings before greasing them to prevent contamination. Replace any missing or damaged fittings. To minimize dirt build-up, avoid excessive greasing.

BASIC MACHINE GREASE FITTING LOCATIONS

Every 50 Hours (or weekly)

Refer to the illustration on the facing page for locations.

CHASSIS AREA

- 1 Wheel spindle pins (per axle)4
- 2 Axle pivot pins (rear axle)2
- 3 Drive shaft, u-joint2
- 4 Drive shaft, slip joint (front axle)1
- 5 Base end lift cylinder pivot pin1
- 6 Base end slave cylinder pivot pin1

BOOM AREA

- 7 Boom to frame upright pivot pin2
- 8 Rod end slave cylinder pivot pin1
- 9 Rod end lift cylinder pin1
- 10 Extend cylinder pivot pins3
- 11 Quick-attach to boom nose pivot pins2
- 12 Tilt cylinder pivot pins2
- 13 Boom slide pads - as required, front and rear

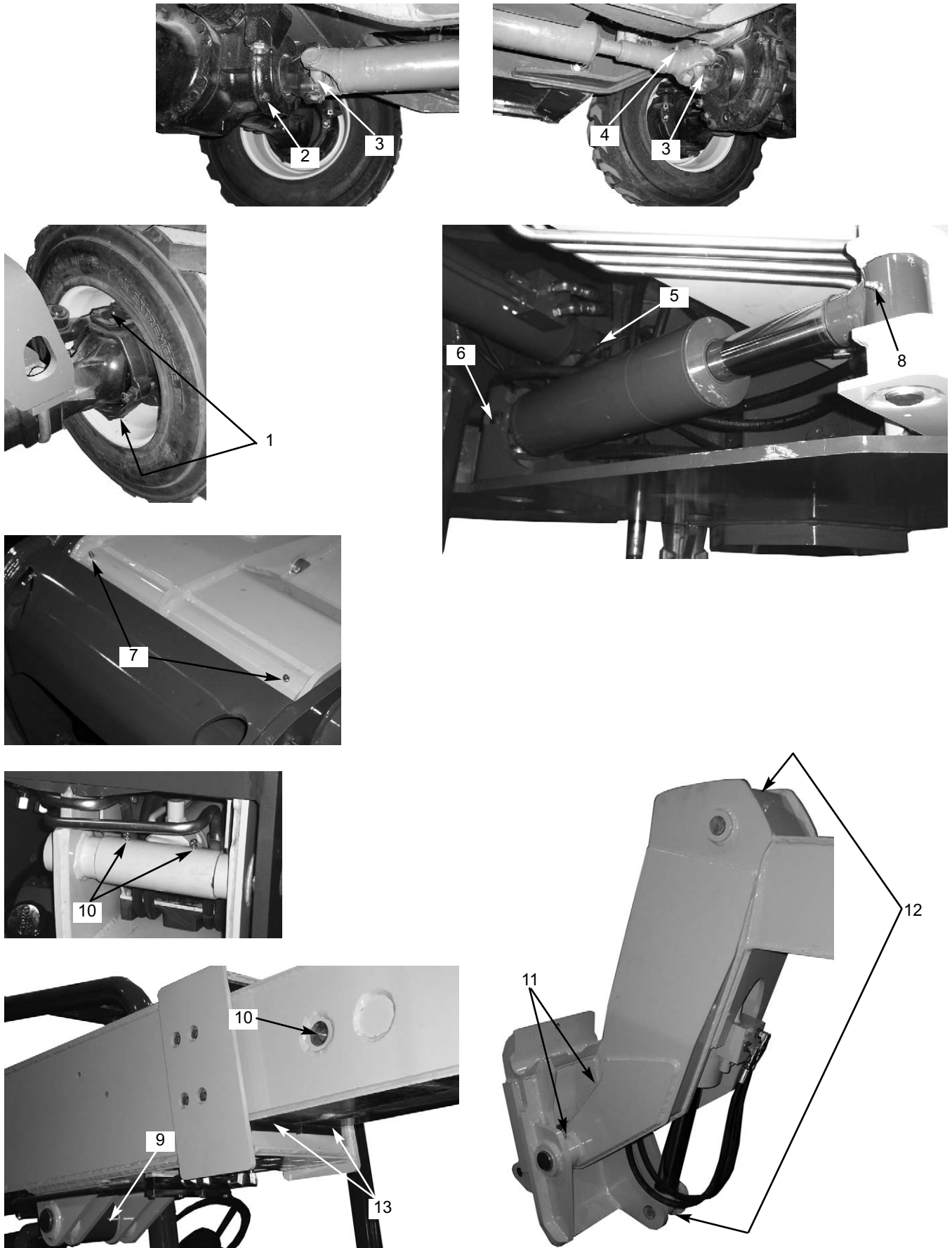

Grease Fittings Locations

Chapter 8

SERVICE AND STORAGE

GENERAL INFORMATION

This Service and Storage chapter describes procedures to follow for making routine maintenance checks, adjustments and replacements. Most of the procedures are also referred to in the Maintenance chapter of this manual. For engine-related adjustments and servicing procedures, refer to the engine manual provided.



WARNING

BEFORE performing any service on the Telescopic Handler, unless expressly instructed to the contrary, exercise the Mandatory Safety Shutdown Procedure (p. 8, Safety chapter). After service has been performed, BE SURE to restore all guards, shields and covers to their original positions before resuming machine operation.

All service routines, with the exception of those described under the “Dealer Services” topic, are owner-operator responsibilities. All operator services described under the subtopics are also referred to on a decal located on the inside right side panel of the operator’s station. Refer to the Lubrication chapter of this manual for lubrication information.

PRECAUTIONS

DO NOT perform any maintenance or repair without the owner’s prior authorization. Allow only trained personnel to service the machine.

Warranty repairs can only be done by an authorized Gehl dealer. Dealers know what portions of the machine are covered under the terms of the Gehl Warranty and what portions are covered by other vendor warranties.

When a problem occurs, do not overlook simple causes, such as an empty fuel tank. Check for leaks and broken connections. Make note of any specific symptoms, noises, etc. and contact your local Gehl dealer.

IMPORTANT: *Always dispose of waste lubricating oils, anti-freeze and hydraulic fluids according to local regulations or take them to a recycling center for disposal. DO NOT pour them onto the ground or into a drain.*

DEALER SERVICES

The following areas of internal components service replacement and operating adjustments should only be by (or under the direction of) an authorized Gehl Telescopic Handler dealer.

IMPORTANT: *DO NOT service or repair major components, unless authorized to do so by your Gehl dealer. Any unauthorized repair will void the warranty.*

POWERTRAIN COMPONENTS

The engine and hydrostatic transmission are coupled directly to each other. All service routines related to the internal components are precise and critical to proper powertrain operation. The axle differential and planetary ends are sophisticated assemblies that require special know-how and tools for servicing.

IMPORTANT: *If any powertrain components are suspected of faulty operation, contact your Gehl dealer for assistance.*

HYDRAULIC SYSTEM COMPONENTS

Valves, pumps, motors and cylinders are sophisticated assemblies, which require special know-how and tools for servicing. All cylinders are appropriately designed with particular strokes, diameters, checks and hose connection provisions unique to the machine application requirements. A schematic (Maintenance chapter) can be used as a guide for service reference, as required.

Internal service on any of these components should only be performed by (or under the direction of) an authorized Gehl Telescopic Handler dealer.

WARNING

Tilt, lift, and extend cylinders have counter-balance valves. These valves keep hydraulic fluid from entering and exiting the cylinders while they are not being activated, and they are under extremely high pressure. Before removing one of these valves, you ARE REQUIRED to call your Gehl dealer or Gehl Service Department. Failure to do so may result in serious injury or death.

ELECTRICAL COMPONENTS

An electrical system schematic is provided, which includes instrumentation, electrical components and switch connections. It is located at the back of this manual and can be used as a guide for service reference, as required.

OPERATOR SERVICES

Some of the operator-related services will require access to components located inside the superstructure, under shields, hoods and covers. The chart on this page notes the components accessed in each particular area.

ACCESS TO COMPONENTS CHART

Component	Operator's Station	Frame	Front Frame Cover	Front Engine Cover	Rear Engine Cover
Axle (underside)		●			
Engine				●	
Hydrostatic Transmission			●	●	
Drive Shaft (underside)		●			
Main Control Valve (center)	●				
Muffler (rear)					●
Air Cleaner (front)				●	
Battery (front)				●	
Radiator					●
Brake Valve (center)			●		
Travel Controls (steer column)	●				
Boom Controls (right inside)	●				
Hydraulic Test Ports				●	
Hourmeter (dash)	●				
Switches/Indicators (dash)	●				
Hydraulic Pump (front)				●	
Hydraulic Filter					●
Misc. Hydraulic Valves		●	●		
Heater (lower dash area)	●				
Fuse and Relay Panel	●				

WARNING

DO NOT smoke or allow any open flames in the area while checking or servicing hydraulic, battery or fuel systems; all contain highly flammable liquids or explosive gases, which can cause an explosion or fire if ignited.

Wear a face shield when you disassemble spring-loaded components or work with battery acid. Wear a helmet or goggles with special lenses when you weld or cut with a torch.

When working beneath a raised machine, always use blocks, jack-stands or other rigid and stable supports. Wear appropriate protective clothing, gloves, and shoes. Keep feet, clothing, hands and hair away from moving parts.

Always wear safety glasses or goggles for eye protection from electric arcs from shorts, fluids under pressure, and flying debris or loose material when the engine is running or tools are used for grinding or pounding.

NEVER weld on bucket, forks, boom, support frame or ROPS/FOPS without the consent of the manufacturer. These components may be made with metals that require special welding techniques, or with designs that do not allow weld repairs. NEVER cut or weld on fuel lines or tanks.

If repair welding is ever required, BE SURE to attach the ground (-) cable from the welder as close as possible to the area to be repaired. Also, remove battery positive (+) terminal connection before welding.

Choose a clean, level work area. Make sure you have sufficient room, clearances, and adequate ventilation. Clean the walking and working surfaces. Remove oil, grease and water to eliminate slippery areas. Utilize sand or oil absorbing compound, as necessary, while servicing the Telescopic Handler.

Before starting inspection and repair, move the machine onto a level surface, shut down engine and remove the ignition key, and release all hydraulic pressure. Always block the boom securely, or lower it to full ground contact. Place all controls in neutral.

Block the tires. Remove the ignition key. Remove only guards or covers that provide needed access. Wipe away excess grease and oil.

Excessively worn or damaged parts can fail and cause injury or death. Replace any cracked or damaged parts. Use only genuine Gehl parts for service.

Use care not to damage machined and polished surfaces. Clean or replace all damaged or painted-over plates and decals that cannot be read.

WARNING

NEVER leave guards off or access doors open when the machine is unattended. Keep bystanders away if access doors are open.

After servicing, check the work performed, that no parts are left over, etc. Install all guards and covers.

Service Every 10 Hours or Daily

CHECKING FUEL TANK LEVEL

After operation each day, the fuel tank should be filled to prevent water from condensing in the tank. To fill, remove the filler cap and add fuel.

CHECKING FUEL FILTER/WATER SEPARATOR

Visually check the fuel filter/water separator for water and debris. Drain the filter/separator if water is present following the draining procedure in the 50 hour service interval.



Fuel Filter/Water Separator

IMPORTANT

Water in the fuel system can cause severe engine damage. Drain water from the fuel filter/water separator anytime water is present.

CHECKING ENGINE OIL LEVEL

With the machine on level ground, and the engine stopped for ten minutes or more, open the right side engine cover and remove the engine dipstick. Wipe it clean, re-insert it and remove to obtain a reading. If the oil level is down, or below the ADD mark, fill with the required amount of oil to bring the level to the FULL mark. See the *Lubrication* chapter for the type of oil to use.

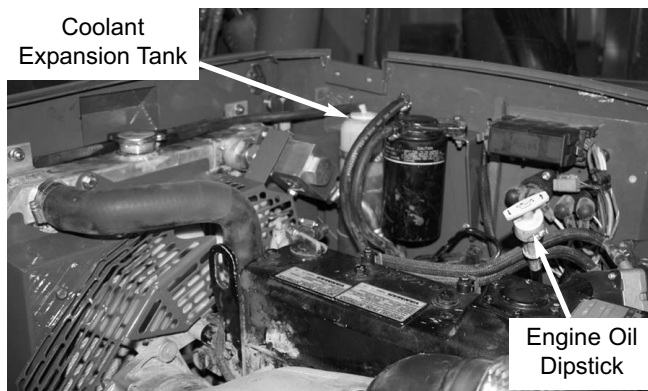

CHECKING COOLANT LEVEL

Check the coolant level before starting the machine the first time every day. With the machine on level ground, open the engine cover. Check that the coolant in the coolant expansion tank is between the Full and Add marks on the tank.

If the coolant is below the Add mark on the tank, remove the cap and add a low-silicate ethylene glycol based coolant mixed with quality water and supplemental coolant additives (SCAs) suitable for heavy-duty diesel engines to the coolant expansion tank. See the engine manual for additional information. Replace the cap securely.

WARNING

DO NOT remove the radiator cap when the engine is running hot or overheated. Coolant is extremely hot and under pressure and it can burn your skin.

NOTE: *The coolant system is designed for coolant top-off only through the expansion tank. Do not add coolant directly to the radiator.*

CHECKING RADIATOR FOR DEBRIS

With the machine on level ground, open the engine cover. Remove the rear radiator cover by turning the two quarter turn latches counter-clockwise. Remove the cover by lifting up and to the rear. If necessary, clean the radiator fins of debris by blowing compressed air or water through the radiator fins from either side of the radiator.

It may be best to clean as much as possible by blowing from the inside of the radiator first, then blowing from the outside of the radiator until the air or water is free of dirt and debris.

IMPORTANT: *Use caution when cleaning the radiator. High pressure air or water may bend radiator fins which will reduce the radiator cooling capacity.*

CHECKING HYDRAULIC OIL LEVEL

The machine must be on level ground with boom lowered and completely retracted. The fluid **MUST** be cool when checking the reservoir level, to reduce the possibility of overfilling the hydraulic system.

Open the right side engine cover and locate the sight gauge below the battery compartment. The oil level should be at the midpoint of the sight gauge. If the oil level is down, or below the sight gauge, fill with the required amount of oil. See the *Lubrication* chapter for the type of oil to use.

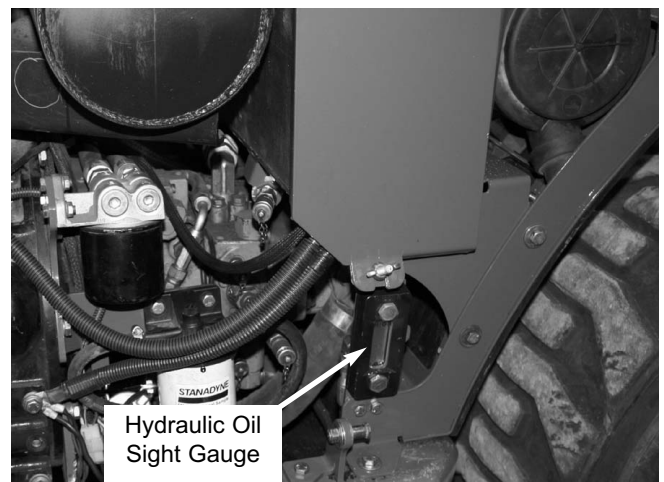

IMPORTANT: *Be careful when removing the reservoir filler cap so that no dirt or other foreign matter enters the hydraulic system. DO NOT OVERFILL.*

CHECKING BRAKE RESERVOIR LEVEL

Remove the cover on the front of the frame. Remove the reservoir cover to check the fluid level. If low, fill to the proper level with the correct fluid. See the *Lubrication* chapter for the type of fluid to use.

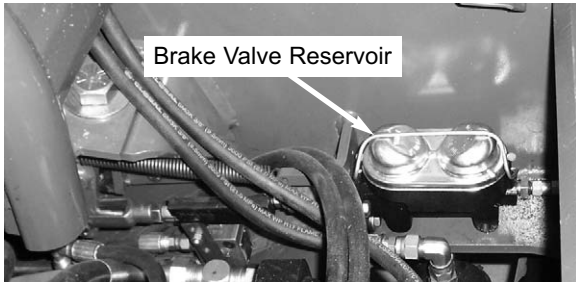

CHECKING TIRE PRESSURES

To ensure proper operating stability and extend tire life, proper and equal tire pressure should be maintained in all four tires. Check tire pressures “cold.” Inflate as necessary per the chart below:

12-16.5 NHS 10 PR: 65 psi (450 kPa)

NOTE: *If the tires have been filled with water or calcium chloride for ballast, a calcium chloride tire pressure gauge MUST be used to check the tire pressure.*

To ensure proper load carrying capability, original equipment tires comply with the specifications published in the *Tire and Rim Association Yearbook*. Replacement tires **MUST** meet the same specifications. When replacing tires, be sure all tires are of the same type, quality and load rating, and the same size as the original equipment. When removing tires, follow industry safety practices. Deflate completely prior to removal. After assembly of the tire on the rim, use a safety cage or restraining device while inflating.

WARNING

Inflating or servicing tires can be dangerous. Whenever possible, trained personnel should service and mount tires. To avoid possible death or serious injury, follow the safety precautions below:

1. **BE SURE** the rim is clean and free of rust.
2. Lubricate both the tire beads and rim flanges with a soap solution. **DO NOT** use oil or grease.

3. **DO NOT** place your fingers on the tire bead or rim during inflation. Use a clip-on tire chuck with a remote hose and gauge, which allows you to stand clear of the tire while inflating it.
4. **NEVER** inflate beyond 35 psi (240 kPa) to seat the beads. If the beads have not seated by the time the pressure reaches 35 psi (240 kPa), deflate the assembly, reposition the tire on the rim, relubricate both parts and re-inflate. Inflation pressure beyond 35 psi (240 kPa) with unseated beads may break the bead or rim with explosive force sufficient to cause death or serious injury.
5. After seating the beads, adjust the inflation pressure to the recommended operating pressure listed.
6. **DO NOT** weld, braze, or otherwise attempt to repair and use a damaged rim.

CHECKING WHEEL NUT TORQUE

On new machines, or any time a wheel has been removed, re-torque until 450 ft.-lbs. (610 Nm) is maintained.

CHECKING INSTRUMENTS OPERATION

Allow the engine to warm up for about five minutes before beginning operation. Indicator lamps should be OFF and gauges in the multi-function display should register normal readings.

CHECKING GENERAL MACHINE OPERATION AND CONDITION

Are any decals missing or damaged? Are all guards, shields and covers in place? Do all controls function smoothly and properly? Are there any abnormal vibrations or noises? Are any hose or fitting connections leaking? Is the engine exhaust color normal?

Service Every 50 Hours or Weekly

LUBRICATING GREASE POINTS

Refer to the *Lubrication* chapter of this manual for weekly grease fitting locations and other related details.

DRAINING FUEL FILTER/WATER SEPARATOR

IMPORTANT

Water in the fuel system can cause severe engine damage. Drain water from the fuel filter/water separator anytime water is present.

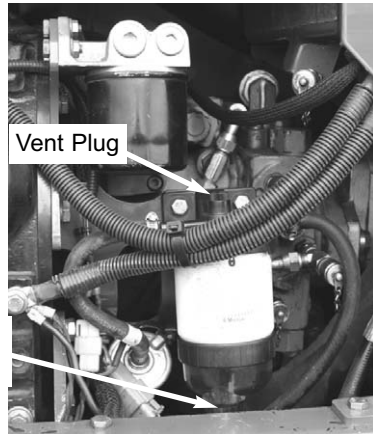

Fuel Filter/Water Separator

Small amounts of water can be drained from the fuel filter/water separator. Place a suitable container under the water separator to catch drained water. Loosen the drain screw to drain water accumulation until clear fuel is flowing. It may be necessary to loosen vent plug to allow water to drain.

New Machine Service

The following initial oil and filter changes should be made on a new machine:

1. Change the engine oil and filter after the first 50 hours of use.
2. Change the hydraulic return filter element after the first 100 hours of use.

Thereafter these changes should be made at the regular maintenance schedule listed below. Refer to those schedules for the necessary procedures.

Engine Oil and Filter	(250 Hours)
Hydraulic Return Filter Element	(500 Hours)

Service Every 250 Hours or Quarterly

Perform all other service requirements up to this point, as well as the following:

CHECKING AXLE OIL LEVELS

Differential

NOTE: *The Telescopic Handler should be on a level surface for this procedure.*

Remove the oil check/fill plug. See illustration. Oil should flow from the hole. If low, add oil until it flows from the hole. Replace the plug, wait 10 to 15 minutes and repeat the fill procedure. Continue this process until the differential is full. Refer to the Lubrication chapter for the proper oil specification. Replace the check/fill plug.

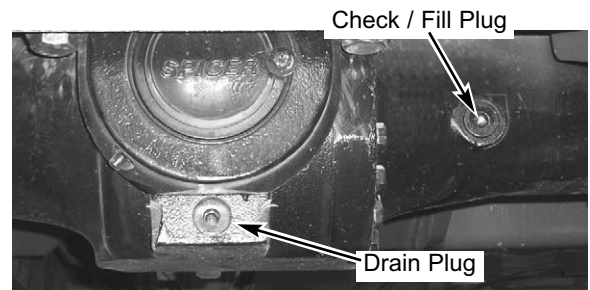

Front Axle Transfer Case

NOTE: *The Telescopic Handler should be on a level surface for this procedure.*

Remove the oil check/fill plug. See illustration. Oil should flow from the hole. If low, add oil until it flows from the hole. Replace the plug, wait 10 to 15 minutes and repeat the fill procedure. Continue this process until the differential is full. Refer to the Lubrication chapter for the proper oil specification. Replace the check/fill plug.

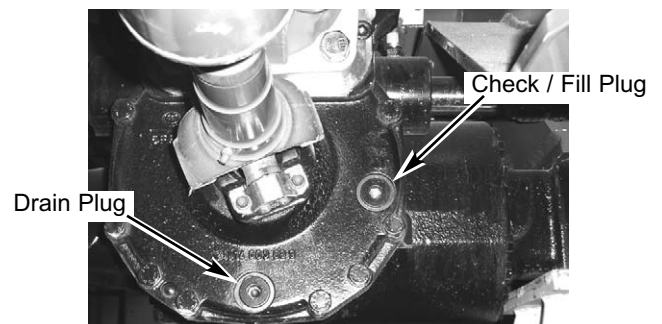

Planetary Hubs

NOTE: *The planetary hubs can be checked without jacking up the machine.*

The planetary hubs have one plug each used for filling and draining. Refer to illustration above. For checking the level and filling, position the wheel until the oil level arrow is horizontal. Remove the plug. If oil does not run out, add oil until it overflows. Check the remaining hubs the same way. Refer to the oil specifications in the *Lubrication* chapter of this manual.

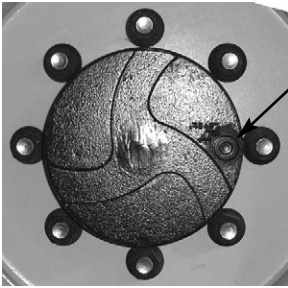

Plug in fill and check position.

CHANGING ENGINE OIL AND FILTER

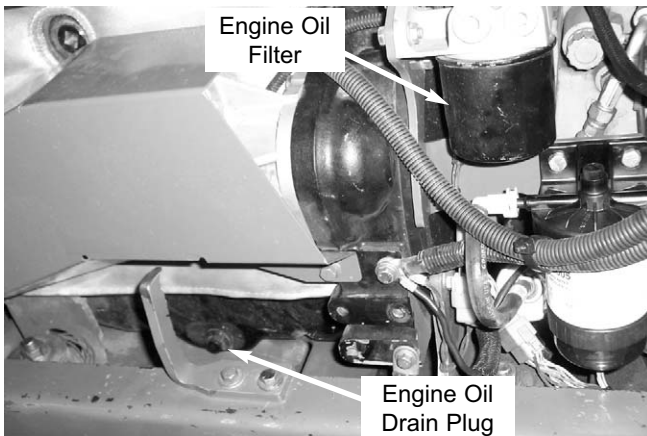

Change the engine oil and filter using the following procedure:

1. With the engine warm, open the cover under the engine to access the drain plug. Remove the crankcase drain plug.

IMPORTANT: *DO NOT discharge oil onto ground. Catch and dispose of per local waste disposal regulations.*

2. The engine oil filter should be changed at every oil change interval. Remove and discard the disposable filter. Wipe the gasket sealing area of the filter head mounting surface with a clean cloth.

IMPORTANT: *Use only genuine OEM engine replacement filters.*

3. Apply a thin coat of clean oil to the new oil filter gasket. Hand tighten. Refill the crankcase with new oil. Follow specifications in the *Lubrication* chapter for type and viscosity of new oil.
4. After new oil has been added, run the engine at idle speed until the oil pressure lamp is OFF. Check for leaks at the filter and drain plug. Re-tighten only as much as necessary to eliminate leakage.

CHANGING FUEL FILTERS

This machine is equipped with a water separator/fuel filter and fuel filter. See the illustration for filter locations.

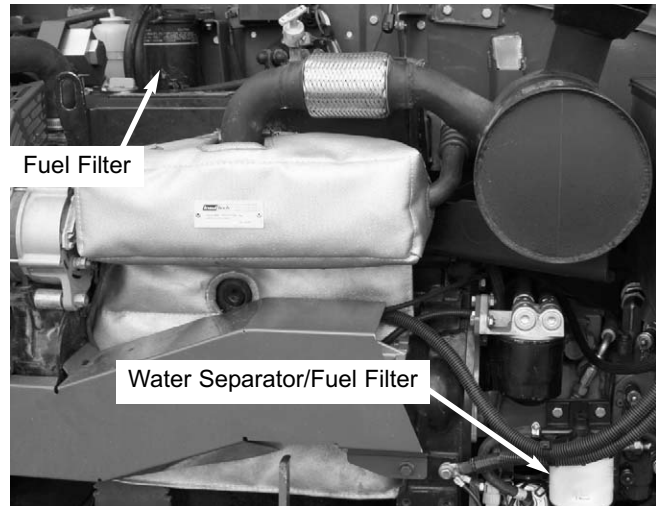

WARNING

NEVER service the fuel system while smoking, while near an open flame, or after the engine has been operated and is hot.

1. Place a suitable container under the water separator/fuel filter to catch any fuel.
2. Remove water separator/fuel filter element by rotating the filter counter-clockwise until a detent is felt. Pull the filter down from the filter head.
3. Once filter is removed, remove the water separator from the element by turning it counter-clockwise.
4. Clean the water separator then install it on the replacement filter.
5. Clean the sealing surface of the filter head.
6. Install the water separator/fuel filter by pushing it up onto the filter head and then turning it clockwise until the detent is felt.

7. Place a suitable container under the second fuel filter. This filter is threaded onto the filter head. Using a filter wrench or by hand remove the filter by turning it counter-clockwise.
8. Clean the sealing surface of the filter head.
9. Apply a light coat of oil or diesel fuel to the rubber gasket on the new filter.
10. Thread the filter on using a filter wrench or by hand until the seal contacts the head. Then tighten the filter an additional 3/4 turn.
11. The engine is self priming. To remove air from the system before starting the engine, turn the ignition key to the "ON" position for 15 seconds.
12. Start the engine and check for leaks.

Priming the Fuel System

If the engine runs out of fuel or maintenance on the fuel system has been performed, the fuel system will need to be primed. Refer to the following fuel priming procedure. Refer to the engine manual for additional fuel priming procedures.

WARNING

Escaping diesel fuel under pressure can have sufficient force to penetrate the skin. Before applying pressure to the fuel system, BE SURE all connections are tight and lines and hoses are not damaged. Use a piece of wood or cardboard to search for suspected leaks. If injured by escaping fuel, see a doctor familiar with this type of injury at once or gangrene may result.

1. Turn the ignition key to the "ON" position for 15 seconds. This will allow the electric fuel pump to prime the fuel system.
2. NEVER use the starter motor to crank the engine in order to prime the fuel system. This may cause the starter motor to overheat and damage the coils, pinion and / or ring gear.

NOTE: Only an authorized engine dealer can perform warranty service on the engine.

Diesel Fuel Injectors

Whenever faulty or plugged injectors are indicated, see your authorized engine dealer.

Diesel Injection Pump Timing

Whenever injection pump timing, or other pump service is indicated by abnormal engine operation, contact your engine dealer.

CHECKING THE BATTERY

The battery furnished in the machine is a 12-volt, wet-cell battery.

Handling Battery Safely

The top of the battery must always be kept clean. Clean the battery with a brush dipped in an alkaline solution (ammonia or baking soda and water). After the foaming has stopped, flush the top of the battery with clean water. If the terminals and cable connection clamps are corroded or have a buildup, disconnect the cables and clean the terminals and clamps with the same alkaline solution.

WARNING

Explosive gas is produced while a battery is in use or being charged. Keep flames or sparks away from the battery area. Make sure battery is charged in a well-ventilated area.

NEVER lay a metal object on top of a battery, because a short circuit can result.

Battery acid is harmful on contact with skin and fabrics. If acid spills, follow these first-aid tips:

1. **IMMEDIATELY** remove any clothing on which acid spills.
2. If acid contacts the skin, rinse the affected area with running water for 10 to 15 minutes.
3. If acid comes in contact with the eyes, flood the eyes with running water for 10 to 15 minutes. See a doctor at once. NEVER use any medication or eye drops unless prescribed by a doctor.
4. To neutralize acid spilled on the floor, use one of the following mixtures:
 - a. 1 pound (0.5 kg) of baking soda in 4 quarts (4 liters) of water.
 - b. 1 pint (0.4 liters) of household ammonia in 4 quarts (4 liters) of water.

Whenever battery is removed from the unit, BE SURE to disconnect the negative (-) battery terminal connection first.

Jump Starting

If the battery becomes discharged or does not have enough power to start the engine, use jumper cables and the following procedure to jump-start the engine.

WARNING

The ONLY safe method for jump-starting a discharged battery is for TWO PEOPLE to perform the following procedure. The second person is needed for removing the jumper cables so that the operator does not have to leave the operator's compartment while the engine is running. NEVER connect the jumper cables directly to the starter solenoid of either engine. DO NOT start the engine from any position other than the operator's seat, and then ONLY after making sure all controls are in "neutral."

Closely follow the jump-start procedures, in the order listed, to avoid personal injury. In addition, wear safety glasses to protect your eyes, and avoid leaning over the batteries while jump-starting.

DO NOT attempt to jump-start the machine if the battery is frozen, because this may cause it to rupture or explode.

IMPORTANT: *BE SURE that the jumper battery is also a 12-volt D. C. battery, and the vehicle used for jump starting has a negative-ground electrical system.*

1. Turn the key switches on both vehicles to "OFF." Be sure that both vehicles are in "Neutral" and NOT touching.
2. Connect one end of the positive (+) jumper cable to the positive (+) battery terminal on the disabled machine first. DO NOT allow the positive (+) jumper cable clamps to touch any metal other than the positive (+) battery terminals. Connect the other end of the positive jumper cable to the jumper battery positive (+) terminal.
3. Connect one end of the negative (-) jumper cable

to the jumper battery negative (-) terminal.

4. Make the final negative (-) jumper cable connection to the disabled machine's engine block or frame (ground) – NOT to the disabled battery negative post. If making the connection to the engine, keep the jumper clamp away from the battery, fuel lines, and moving parts.

NOTE: *Twist the jumper cable clamps on the battery terminals to ensure a good electrical connection.*

5. Proceed to start the machine. If it does not start immediately, start the jumper vehicle engine to avoid excessive drain on the booster battery.
6. After the machine is started and running smoothly, have the second person remove the jumper cables (negative (-) jumper cable first) from the jumper vehicle battery, and then from the disabled machine, while ensuring NOT to short the two cables together.

Allow sufficient time for the alternator to build up a charge in the battery before operating the machine or shutting off the engine.

NOTE: *If the battery frequently becomes discharged, have the battery checked for possible dead cells, or troubleshoot the electrical system for possible short circuits or damaged wire insulation.*

CHECKING BOOM SLIDE PADS WEAR AND CLEARANCE

The boom is equipped with special nylon low friction slide pads between the telescopic sections. (See illustration on the next page.) These are pre-greased and initially worn-in at the factory. Normally greasing is not required, except for maintaining a light film of grease on the pad tracking areas of the boom sections. An exception would be if a boom section has been replaced.

Visually check for loose pad bolts. The bolts are torqued to 30 ft.-lbs. (40 Nm). If the bolts are re-torqued at any time, Loctite® 271 (red) thread lock must be re-applied to the bolts.

If the boom starts to chatter under load, grease the slide pads and wipe off the excess grease. Maintain a clearance of 1/16" between the top or side slide pads and the boom. Shims can be added to achieve the proper clearance. Loosen the bolts and insert shims until proper clearance is obtained.

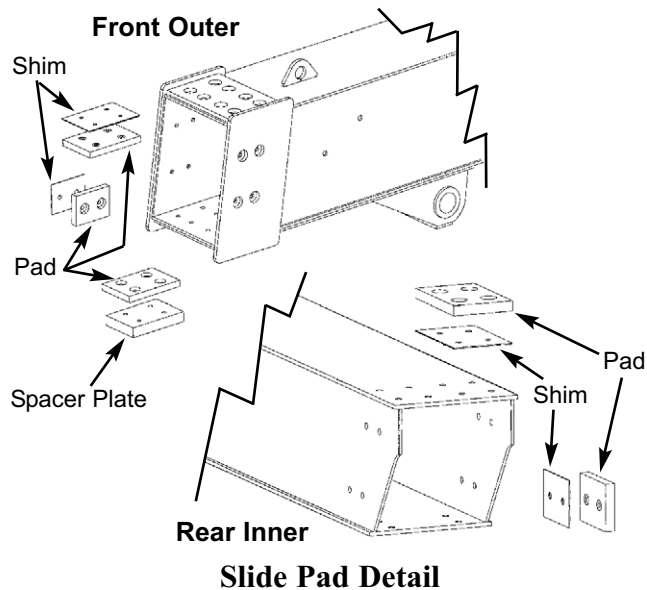

Slide Pad Detail

NOTE: When inserting shims in the side slide pads, be sure to place equal shims on both sides of the boom for even distribution of clearance.

Re-apply Loctite® thread lock to the bolts and re-torque to 30 ft.-lbs. (40 Nm). Bottom slide pads should not be shimmed and should be replaced when the thickness is worn down to 3/8" (9.5 mm).

WARNING

Failure to maintain proper slide pad clearance and thickness could cause damage to the boom and result in sudden boom failure.

CLEAN AIR CONDITIONING CONDENSER

NOTE: Clean the condenser more often if there is a noticeable decrease in A/C performance.

IMPORTANT: Do not use a water jet or high-pressure steam, because this could damage the fins.

1. Remove the six screws (1) from the top cover of the condenser.
2. Remove the cover to gain access to the condenser (2).
3. Clean any large debris that may have collected on the top side of the condenser.
4. Clean the condenser use a jet of compressed air aimed in the same direction as the air flow.

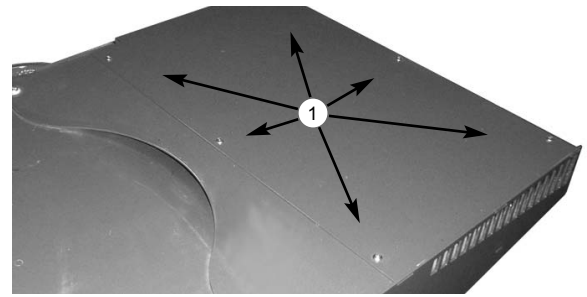

Top View of Condenser Assembly

NOTE: To aid in the cleaning process, carry out this operation with the condenser fans running.



5. Re-install the top cover.

CLEAN/CHANGE CAB VENTILATION FILTER

NOTE: Clean or change the filter more often if there is a noticeable decrease in air flow from the air vents.

1. Remove the four screws (1) from the filter protective cover located on the lower portion of the dash in front of the brake pedal.

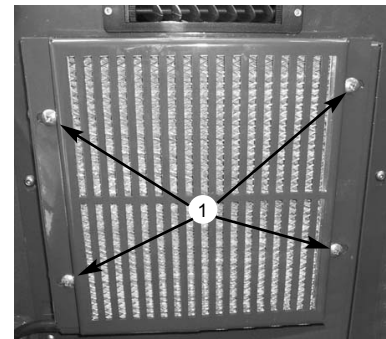

2. Remove the filter from the cover.
3. Clean the filter with a jet of compressed air.
4. Check the condition of the filter and replace it if necessary.
5. Install the filter in the protective cover, then re-install the protective cover.

Service Every 500 Hours or Half Year

Perform all other service requirements up to this point, as well as the following:

CHECKING AND CHANGING HYDRAULIC RETURN FILTER ELEMENT



WARNING

Before servicing the hydraulic filter, lower the boom to the ground.

This spin-on type hydraulic filter element is located under the engine cover behind the radiator. Open the engine cover to access the hydraulic filter. Initial replacement is after the first 100 hours. The hydraulic filter element should be replaced every 500 hours or anytime the indicator on the multi-function display stays lit. Replace the filter using the following the procedure:

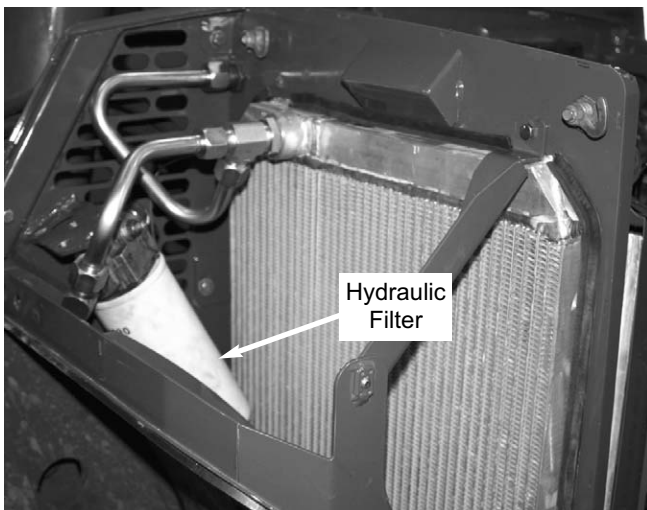

1. Turn off the engine.
2. Place a suitable container under the filter to catch any spilled oil.
3. Spin off the old hydraulic filter element.
3. Wipe the gasket sealing surface of the filter head with a clean cloth.
4. Apply a thin coat of clean oil to the new filter gasket.
5. Spin on the new filter element and hand tighten.
6. Run the engine at full throttle and check for leaks at the filter sealing area.

Service Every 1000 Hours or Yearly

Perform all other service requirements up to this point, as well as the following:

CHECKING AND CHANGING AIR FILTER ELEMENTS

IMPORTANT: Failure to follow proper filter servicing instructions could result in catastrophic engine damage.

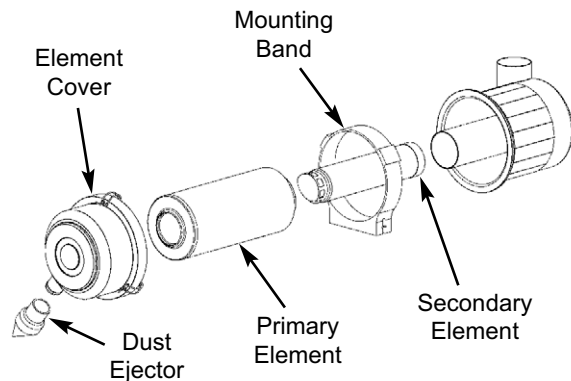
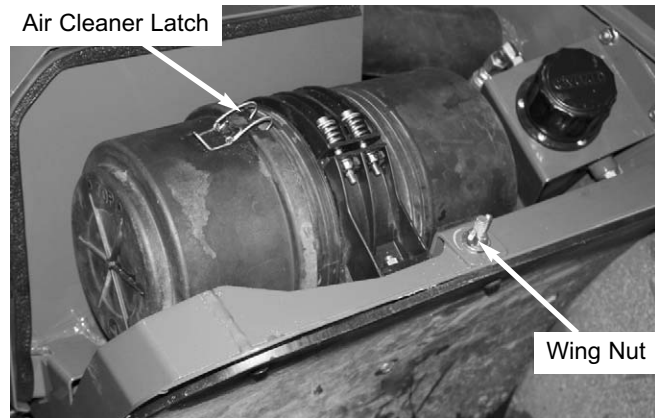

Air Cleaner Assembly

The air cleaner assembly consists of an outer (primary) filter element and an inner (secondary) filter element. The air filter restriction indicator on the multi-function display is lit whenever the air cleaner is restricted.

The outer element should be replaced anytime the restriction indicator stays lit. The inner element should be replaced every third time the outer element is replaced, unless the outer element is damaged or the inner element is visibly dirty. Along with a daily check of the restriction indicator, check that the air cleaner intake hose and clamps, and the mounting bracket hardware are properly secure. Replace the filter following the procedure on the next page:

1. In order to gain access to the latches and clearance to remove the filter elements, remove the wing nut retaining the air cleaner in its mounting position.
2. Unlatch the three latches on the air cleaner and remove the cover. Clean out any dirt in the cover assembly.
3. Carefully pull the outer element out of the housing. Never remove the inner element unless it is to be replaced.
4. Clean out any dirt in the housing. Leave the inner element installed during this step to prevent debris from entering the engine intake manifold.
5. Use a trouble light inside the new outer element to inspect for bad spots, pinholes and ruptures.

IMPORTANT: NEVER use an element that is damaged. Severe engine wear and eventual failure can result if dirt gets through a hole in the element. Cleaning the outer element is not recommended.

NOTE: Replace the inner element only if it is visibly dirty or if the outer element has been replaced three times.

Before removing the inner element from the housing, clean out any dirt build up in the housing. Leave the inner element installed during this step to prevent debris from entering the engine intake manifold. Remove the inner element.

6. Check the inside of the housing for any damage that may interfere with the elements.
7. Be sure that the element sealing surfaces are clean.
8. Insert the element(s), making sure that they are seated properly.
9. Secure the cover to the housing with the three clamps.
10. Check the hose connections and make sure they are all clamped and tightened properly.
11. Re-position the air cleaner in its mounting position and re-install the wing nut.

CHANGING AXLE DIFFERENTIAL AND PLANETARY OIL

Differentials

1. Remove the check/fill plug. Remove the drain plug and drain out the old oil. Replace the drain plug (see illustration).

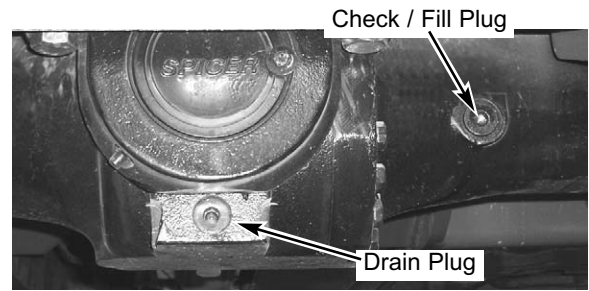

IMPORTANT: DO NOT discharge oil onto ground. Catch and dispose of per local waste disposal regulations.

2. Fill the differential with oil as specified in the Lubrication chapter. When the oil flows from the check hole, replace the plug. Wait 10 to 15 minutes and repeat this process until the axle is full. Repeat this procedure with the other axle.

Front Axle Transfer Case

1. Remove the check/fill plug. Remove the drain plug and drain out the old oil. Replace the drain plug (see illustration).

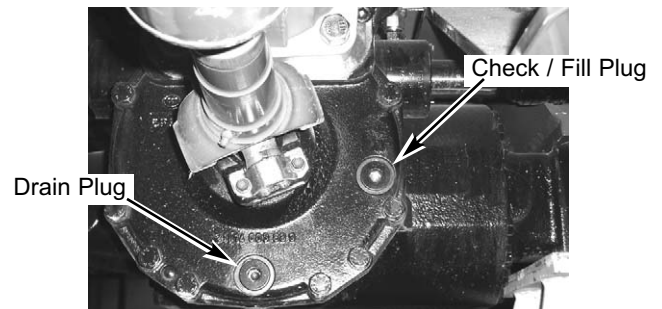

IMPORTANT: DO NOT discharge oil onto ground. Catch and dispose of per local waste disposal regulations.

2. Fill the transfer case with oil as specified in the Lubrication chapter. When the oil flows from the check hole, replace the plug. Wait 10 to 15 minutes and repeat this process until the transfer case is full.

Axle Planetary Hubs

The hubs have one plug each used for draining and filling (see illustration).

1. Position the wheel until the oil level arrow points down. Remove the plug and allow the oil to drain out. Replace the plug.

IMPORTANT: DO NOT discharge oil onto ground. Catch and dispose of per local waste disposal regulations.

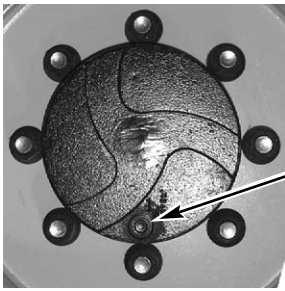

Plug in drain position.

2. Re-position the hub so the oil level arrow is horizontal. Fill with clean oil as specified in the Lubrication chapter. When the oil runs out, install the drain/fill plug. Repeat this procedure on the other three hubs.

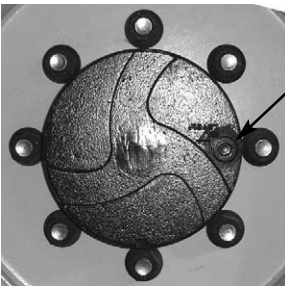

Plug in fill and check position.

CHANGING HYDRAULIC RESERVOIR OIL

Clean all dirt and debris from around the drain plug area.

1. Remove the drain plug and drain out all used oil. Wash or blow off all collected particles from the magnetic drain plug.

IMPORTANT: Do NOT discharge oil onto ground. Catch and dispose of per local waste disposal regulations.

2. Flush out the bottom of the tank with clean hydraulic oil. Re-install the drain plug.
3. Fill the tank with fresh oil. Follow specifications found in *Lubrication* chapter of this manual.

WARNING

Escaping hydraulic oil under pressure can have sufficient force to penetrate the skin. Before applying pressure to the hydraulic system, be sure all connections are tight and lines and hoses are not damaged. Use a piece of wood or cardboard to search for suspected leaks. If injured by escaping hydraulic oil, see a doctor familiar with this type of injury at once or gangrene may result.

IMPORTANT: Hydraulic fluid and filters should be replaced any time contamination is present before the normally scheduled change.

CHANGING RADIATOR COOLANT

Drain, flush and refill the cooling system as follows:

IMPORTANT: DO NOT discharge coolant onto ground. Catch and dispose of per local waste disposal regulations.

WARNING

Remove the radiator cap only when the engine is cool, or painful burns could result.

1. Remove the engine belly pan.
2. Loosen the radiator cap to its stop. This will release any system pressure. Remove the cap when all pressure is bled off.
3. Attach a 3/8" hose to the drain cock and route it through the belly pan opening to a collection container positioned below the radiator.

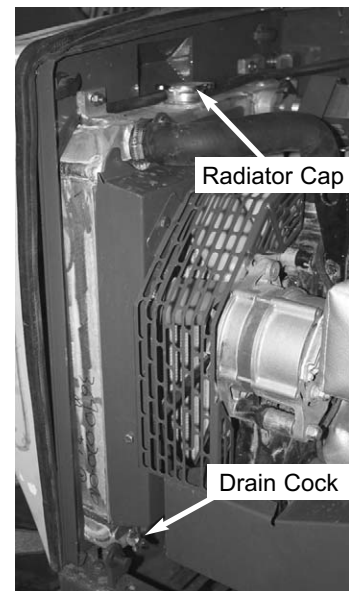

4. Loosen the radiator drain cock to drain the radiator.
5. Remove the coolant hose from the engine oil cooler to allow coolant to drain from the engine block.

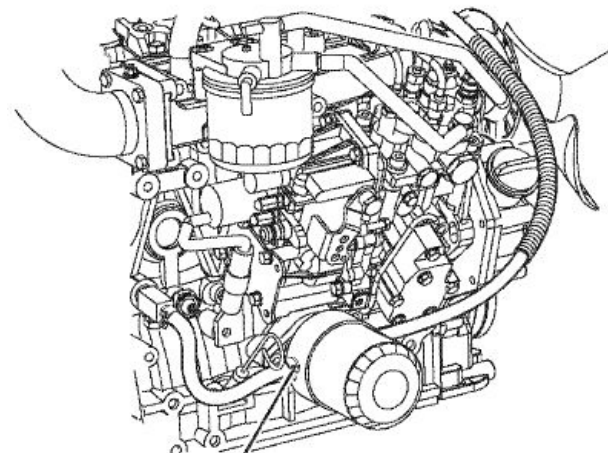

Oil Cooler
Coolant Hose

Service Every 2000 Hours or Two Years

- When all coolant is drained, flush the system with clean fresh water to remove any rust, scale and contaminants. Allow the radiator and engine block to drain completely.
- Replace all drain plugs and tighten the radiator drain cock. Clean the cooling fins in the radiator with compressed air or water pressure.

IMPORTANT: *Fill the cooling system with a low-silicate ethylene glycol based coolant mixed with quality water and supplemental coolant additives (SCAs) suitable for heavy-duty diesel engines. See the engine manual for additional information.*

- Pour the coolant slowly into the radiator until the coolant is at the bottom of the filler neck. Remove the cap of the expansion tank and add coolant to the full mark.
- Inspect the radiator cap seal before installing it. Replace it if it appears to be damaged.
- Run the engine until it reaches operating temperature. Check the coolant level in the expansion tank. Add coolant to the expansion tank to bring the level up to the full mark.

NOTE: *Check the engine temperature gauge every minute or two after coolant has been changed. Air pockets can form and it may be necessary to refill the cooling system after a short period of use, as the air bleeds out of the system.*

CHECKING ALTERNATOR AND FAN BELT CONDITION

Refer to the engine manual for proper belt tension adjustment and replacement procedures. If the belt shows wear or cuts, or cracks, it should be replaced. Order replacement belt from your engine dealer.

CHECKING EXHAUST SYSTEM

Examine the muffler and tail pipe for possible holes. Re-tighten any loose clamps and make sure the manifold outlet gasket is not leaking. Examine the exhaust insulating blanket for holes or tears. To prevent excessive heat build up in the engine compartment the insulating blanket should be replaced when it is damaged.

IMPORTANT: *To prevent damaging the insulating blanket, do not spray it with high pressure water blast when cleaning the engine.*

Perform all other service requirements up to this point, as well as the following.

CHECKING HYDRAULIC SYSTEM RELIEF PRESSURES

Pressure settings for relief valves are pre-set at the factory. A test port is provided under the engine cover.

Before conducting any test port pressure checks, check the engine speed. Engine speed must be 1000 RPM at idle and 2530 RPM at high idle.

Steering Relief Pressure

Plug a 3000 psi (207 bar) oil- or liquid-filled gauge into the test port. Turn the steering wheel fully to the right or left. The gauge should read 2400 psi (165 bar).

Main Relief Pressure

Plug a 3500 psi (241 bar) oil- or liquid-filled gauge into the test port. Fully retract the boom forcing oil to flow over the relief valve. The gauge should read 3350 psi (231 bar).

STORING THE MACHINE

If the Telescopic Handler will not be operated for a period of three months or more, prepare and store it using the following procedure:

NOTE: *If the storage area is outdoors or in a harsh environment, the storage procedure should be followed if the Telescopic Handler is to be stored for one month.*

Before Storage

Perform the following prior to placing the machine in storage:

- Wash off the entire machine.
- Lubricate all grease fittings as described in the Lubrication chapter of this manual.
- Change engine oil as outlined in the Service and Storage chapter of this manual.
- If the machine will not be operated for a month or longer, apply grease to all exposed hydraulic cylinder rod areas.

5. Disconnect the battery cable clamps and cover the battery or remove the battery from the machine and store it separately.
6. If the ambient temperature (at any time during the storage period) is expected to drop below freezing, make sure the engine coolant is either completely drained from the radiator and engine block or that the amount of anti-freeze in it is adequate to keep the coolant from freezing. Refer to the engine manual for anti-freeze recommendations and quantities.

During Storage

1. About once each month, connect the battery and check all fluid levels to make sure they are at the proper level before starting the engine.
2. Start the engine and allow it to run until it warms up and then move the machine a short distance to help relubricate the internal parts. Run the engine until the battery has a chance to recharge and then shut it off.

IMPORTANT: *If it is desired to operate the hydraulic cylinders at this time, BE SURE to wipe the protective grease (and any adhering dirt) from the cylinder rods prior to starting the engine. After operating, BE SURE to recoat the cylinder rods with grease if the machine is to be returned to storage.*

After Storage

After removing the machine from storage and before operating it, perform the following:

1. Change engine oil and filter to remove condensation or other residues.
2. Wipe off grease from cylinder rods.
3. Lubricate ALL grease fittings.
4. Review and re-familiarize yourself with all safety precautions as outlined in the Safety chapter of this manual.
5. Follow the starting and warm-up procedures as outlined in the Operation and Adjustments chapter of this manual.

Chapter 9

DECALS

GENERAL INFORMATION



ALWAYS read and follow the safety precautions and information shown on decals. If any decals are damaged or unreadable, or if the unit is repainted, the decals must be replaced. If repainting, **BE SURE** that all decals that apply to your machine are affixed in their proper locations

When a decal is applied on a part that is to be replaced, make sure that the replacement part has the decal applied or apply a new decal.

Decal location information is provided to assist in the proper selection and application of new decals, in the event the original decals become damaged or the machine is repainted.

For correct replacement of decals, compare the location photographs to the machine before starting to refinish the unit. Check off each required decal using the illustration reference number to find the part number, description and quantity in the list. Refer to the appropriate illustration for replacement locations.

NOTE: Refer to the Safety chapter of this manual for the specific information provided on the various safety decals.

NEW DECAL APPLICATION

Before applying new decals, surfaces must be free from dirt, dust, grease and other foreign material. To apply a solid-formed decal, remove the smaller portion of the decal backing paper and apply this part of the exposed adhesive backing to the clean surface while maintaining proper position and alignment. Slowly peel off the other portion of the backing paper while applying hand pressure to smooth out decal surface. To apply a die-cut decal, first remove the backing paper. Then, properly position the decal onto the clean mounting surface. After the decal is firmly applied and smoothly pressed down, remove the front covering paper.

PAINT FINISH

Use this list to order paint for refinishing:

184768	One Gallon Yellow
167789	6 (12-oz. Spray Cans) Yellow
167754	One Gallon Gun-Metal Gray
167753	6 (12-oz. Spray Cans) Gun-Metal Gray

Decal Kits

50220158	RS5-19 Telescopic Handler
----------	---------------------------

NOTE: Decals may be purchased in kits or individually.

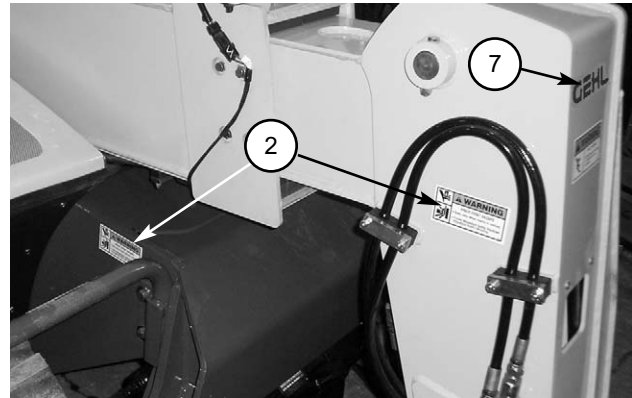
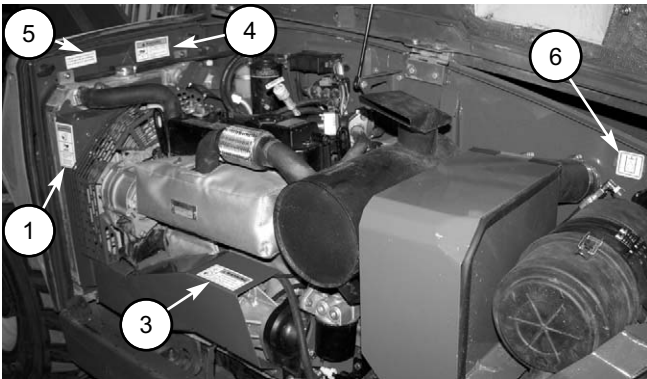

DECAL LOCATIONS

REF. NO.	DESCRIPTION	PART NO.
01	DANGER - HANDS OUT	L70305
02	WARNING - PINCH POINT	L65927
03	WARNING - JUMP START	L65933
04	ANTI-FREEZE	056859
05	COOLANT UNDER PRESSURE	072798
06	HYDRAULIC OIL	137632
07	GEHL, 1.50 X 6.37	104408
08	RS5-19 RH	104900
09	GEHL, 3.7 X 15.92	184043
10	GEHL, 2.75 X 11.67	184305
11	GEHL, 8.00 X 33.95	102025
12	WARNING - HOT SURFACE	L65942

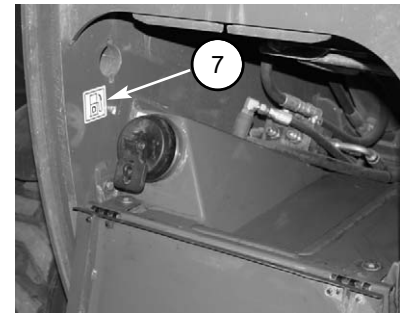
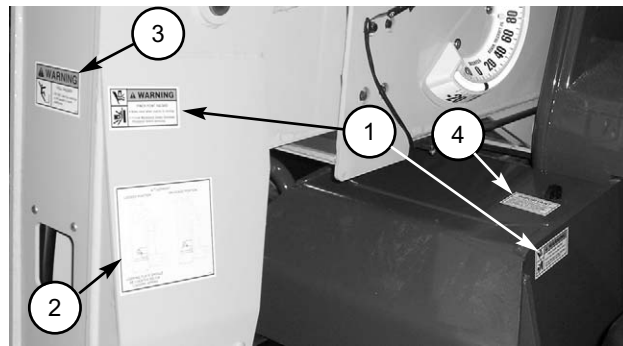
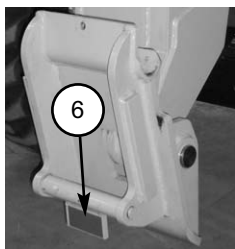
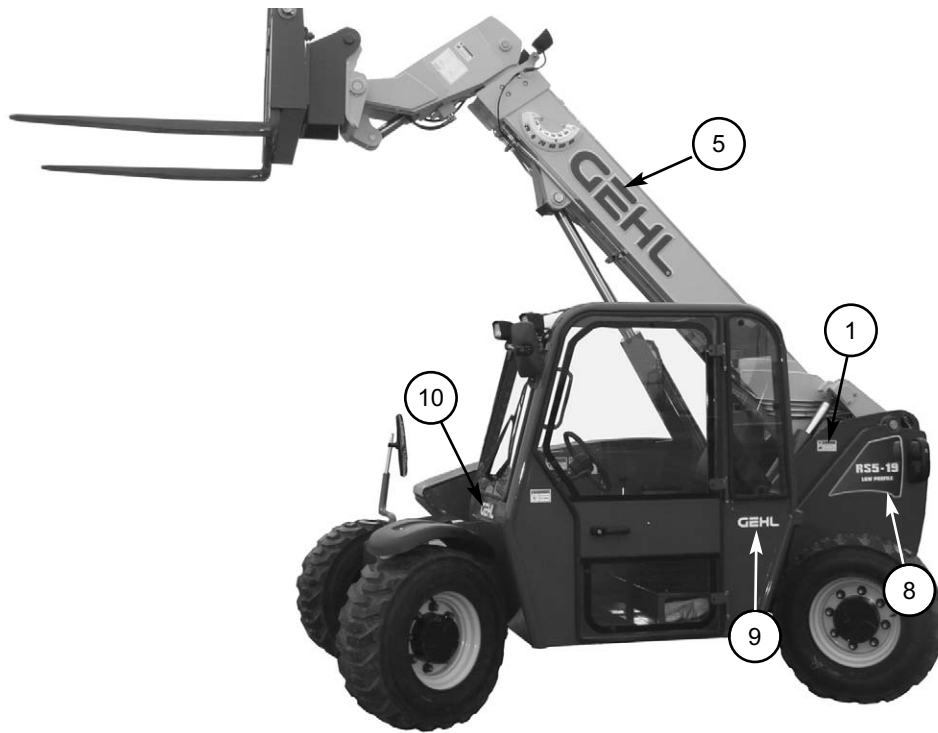

DECAL LOCATIONS

REF. NO.	DESCRIPTION	PART NO.
01	WARNING - PINCH POINT	L65927
02	QUICKATTACH DIAGRAM	L65937
03	DANGER-PERSONNEL INJURY	L65928
04	BRAKE FLUID	L63474
05	Gehl, 8.00 X 33.95"	102025
06	QUICKATTACH UNLOCKED	L66613
07	DIESEL FUEL	137634
08	RS5-19, LH	104899
09	GEHL, 2.00 X 8.49	104833
10	GEHL, 2.75 X 11.67	184305

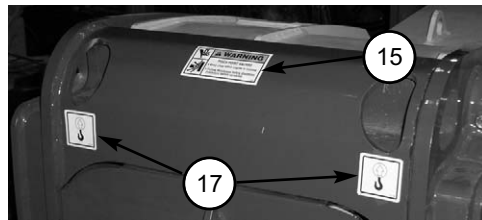
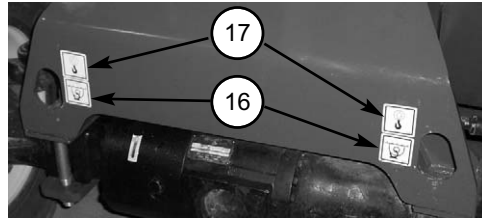
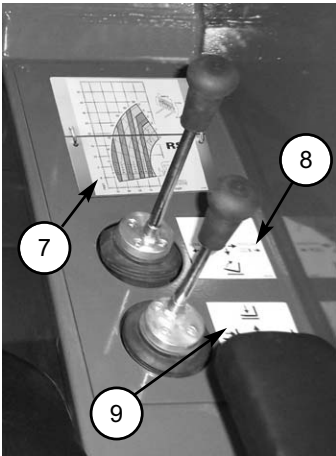
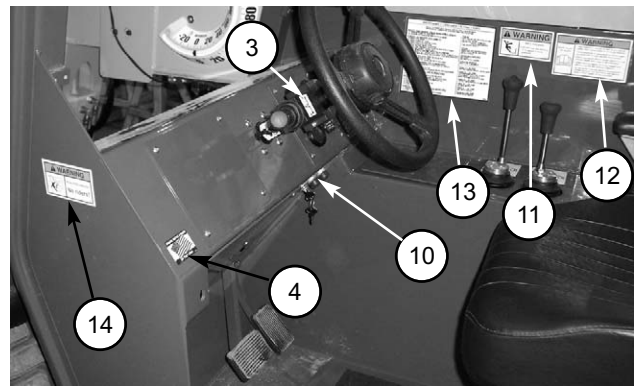
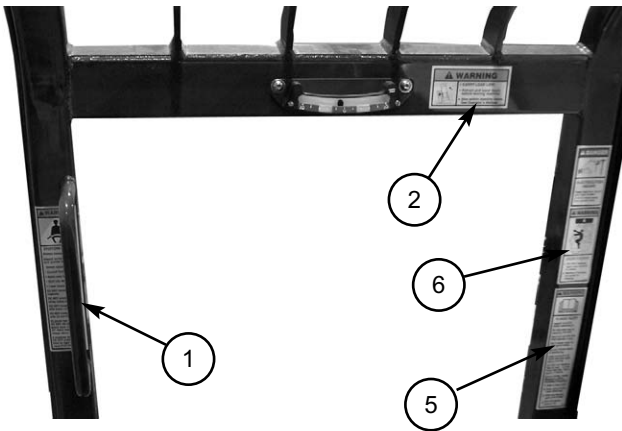

DECAL LOCATIONS

REF. NO.	DESCRIPTION	PART NO.
01	WARNING-TILT HAZARD/GENERAL OPERATOR	L70306
02	WARNING - CARRY LOAD LOW	L65926
03	F-N-R SHIFT	L68295
04	MADE IN USA	140516
05	WARNING - PARK BRAKE/SEAT BELT	101506
06	DANGER-HI VOLT./MOVING PARTS	L70307
07	STANDARD CARRIAGE LOAD CHART	104399
	ROTATING CARRIAGE LOAD CHART	104400
	BUCKET LOAD CHART	104401
	TRUSS BOOM LOAD CHART	104402
08	FORK SHIFT LOAD CHART	105804
	SIDE SHIFT LOAD CHART	210011
09	ATTACHMENT TILT/AUXILIARY	100400
10	BOOM CONTROL	L63631
	IGNITION/START/HORN	50380266
11	DANGER-PERSONNEL INJURY	L65928
12	OPERATOR MANUAL WARNING	100359
13	LUBE CHART	104398
14	NO RIDERS	L65932
15	WARNING - PINCH POINT	L65927
16	TIE DOWN	104945
17	LIFT POINT	104946

Chapter 10

MAINTENANCE

This Maintenance Interval Chart was developed to match the Service and Storage chapter of this manual. Detailed information on each service procedure are in the Service and Storage chapter. A Maintenance Log follows the Maintenance Interval Chart for recording the maintenance procedures performed. Recording the 10-Hour (or Daily) service procedures would be impractical and is therefore not recommended.

IMPORTANT: *Under extreme operating conditions, more frequent service than the recommended intervals may be required. You must decide if your operation requires more frequent service.*

MAINTENANCE INTERVAL CHART

SERVICE PROCEDURE	10 Hours (or Daily)	50 Hours (or Weekly)	100 Hours	250 Hours (or Quarterly)
Checking Fuel Tank Level	●			
Checking Fuel Filter/Water Separator	●			
Checking Engine Oil Level	●			
Checking Coolant Level	●			
Checking Radiator for Debris	●			
Checking Hydraulic Oil Level	●			
Checking Brake Reservoir Level	●			
Checking Tire Pressures	●			
Checking Wheel Nut Torque	● ¹			
Checking Instruments Operation	●			
Checking General Machine Operation and Condition	●			
Lubricating Grease Points		●		
Draining Fuel Filter/Water Separator		●		
Change Engine Oil and Filter		● ²		
Change Hydraulic Return Filter Element			● ³	
Checking Axle Oil Levels				●
Changing Engine Oil and Filter				●
Changing Fuel Filters				●
Checking the Battery				●
Checking Boom Slide Pads Wear and Clearance				●

1 - On new machines, or when a wheel has been removed, until 450 ft.-lbs. (610 Nm) is maintained.

2 - On new machines, after first 50 hours; every 250 hours thereafter.

3 - On new machine, after first 100 hours; every 500 hours thereafter.

MAINTENANCE INTERVAL CHART (CONT.)

SERVICE PROCEDURE	250 Hours (or Quarterly)	500 Hours (or Half Year)	1000 Hours (or Yearly)	2000 Hours (or 2 Years)
Clean A/C Condenser	•			
Clean/Change Cab Ventilation Filter	•			
Checking Hydraulic Restriction Indicator		•		
Changing Hydraulic Return Filter Element		•		
Checking Air Filter Restriction Indicator			•	
Changing Air Filter Element			•	
Changing Axle Differential and Planetary Oil			•	
Changing Hydraulic Reservoir Oil			•	
Changing Radiator Coolant			•	
Checking Alternator and Fan Belt Condition			•	
Checking Exhaust System			•	
Checking Hydraulic System Relief Pressures				•

MAINTENANCE LOG

Date	Hours	Service Procedure

MAINTENANCE LOG

Date	Hours	Service Procedure

ENGINE DIAGNOSTIC TROUBLE CODES (DTCs)

Engine diagnostic trouble codes are displayed in the multi-function display screen.

Diagnostic trouble codes are displayed as a two-part code: Suspect Parameter Number (SPN) and Failure Mode Identifier (FMI), as shown on the following table.

The first part is a Suspect Parameter Number (SPN) followed by a Failure Mode Identifier (FMI). To determine the exact type of failure, both parts (SPN and FMI) of the code are needed.

The SPN identifies the system or the component that has the failure; for example, SPN 000110 indicates a failure in the engine coolant temperature sensor.

The FMI identifies the type of failure that has occurred; for example, FMI 03 indicates a value above normal. Combining SPN 000110 with FMI 03 means the engine coolant temperature input voltage is too high. This example would display in the multi-function display as error code 000110-03.

Always contact your servicing engine dealer for help in correcting the diagnostic trouble codes that are displayed for the engine.

The fault code listing in the following tables are in ascending SPN/FMI codes.

DTC		Error Code Type	Error Description
SPN	FMI		
000091	00	Accelerator Pedal Position Sensor "A"	Above normal operational range
	01	Accelerator Pedal Position Sensor "A"	Below normal operational range
	02	Accelerator Pedal Position Sensor "A"	Intermittent fault
	03	Accelerator Pedal Position Sensor "A"	Shorted to high source
	04	Accelerator Pedal Position Sensor "A"	Shorted to low source
	15	Accelerator Pedal Position Sensor "A"	Not available
000100	01	Oil Pressure	Too Low
	04	Oil Pressure Switch	Shorted to low source
000110	00	Engine Coolant Temperature	Too high
	02	Engine Coolant Temperature Sensor	Intermittent fault
	03	Engine Coolant Temperature Sensor	Shorted to high source
	04	Engine Coolant Temperature Sensor	Shorted to low source
000158	00	System Voltage	Too high
	01	System Voltage	Too low
000167	01	Charge Warning	
	04	Battery Charge Switch	Shorted to low source
000190	00	Engine Speed	Over speed condition
000628	02	E-ECU Internal Fault	FlashROM Check Sum Error (Data Set 1)
	02	E-ECU Internal Fault	FlashROM Check Sum Error (Data Set 2)
	12	E-ECU Internal Fault	FlashROM Check Sum Error (Main Software)
000630	02	E-ECU Internal Fault	EEPROM Check Sum Error (Data Set 2)
	12	E-ECU Internal Fault	EEPROM Read / Write fault
000638	02	Engine	Malfunction
	03	Engine Fuel Rack Actuator	Shorted to high source
	04	Engine Fuel Rack Actuator	Shorted to low source
	07	Engine Fuel Rack Actuator	Mechanical malfunction
000639	12	High Speed CAN Communication	Communication fault

DTC			
SPN	FMI	Error Code Type	Error Description
001078	04	Fuel Injection Pump Speed Sensor	Shorted to low source
001079	02 03 04	Sensor 5V Sensor 5V Sensor 5V	Intermittent fault Shorted to high source Shorted to low source
001136	00 02 03 04	E-ECU Internal Temperature E-ECU Internal Temperature Sensor E-ECU Internal Temperature Sensor E-ECU Internal Temperature Sensor	Too high Intermittent fault Shorted to high source Shorted to low source
001202	02	Immobilizer	System fault
001210	03 04	Engine Fuel Rack Position Sensor Engine Fuel Rack Position Sensor	Shorted to high source Shorted to low source
001485	04	E-ECU Main Relay	Shorted to low source
522241	02 03 04 07	Engine Fuel Rack Actuator Relay Engine Fuel Rack Actuator Relay Engine Fuel Rack Actuator Relay (Reserved)	Intermittent fault Circuit fault B Circuit fault A
522242	02 03 04	Cold Start Device Cold Start Device Cold Start Device	Intermittent fault Circuit fault B Circuit fault A
522243	02 03 04	Air Heater Relay Air Heater Relay Air Heater Relay	Intermittent fault Circuit fault B Circuit fault A
522251	03 04	EGR Stepping Motor "A" EGR Stepping Motor "A"	Circuit fault B Circuit fault A
522252	03 04	EGR Stepping Motor "B" EGR Stepping Motor "B"	Circuit fault B Circuit fault A
522253	03 04	EGR Stepping Motor "C" EGR Stepping Motor "C"	Circuit fault B Circuit fault A
522254	03 04	EGR Stepping Motor "D" EGR Stepping Motor "D"	Circuit fault B Circuit fault A
522314	00	Engine Coolant Temperature	Abnormal temperature
522727	12 12 12	E-ECU internal fault E-ECU internal fault E-ECU internal fault	Sub-CPU Error A Sub-CPU Error B Sub-CPU Error C
522728	12	E-ECU internal fault	Engine Map Data Version Error
522730	08 12	Immobilizer Immobilizer	Pulse Communication fault CAN Communication fault

Electrical Schematic

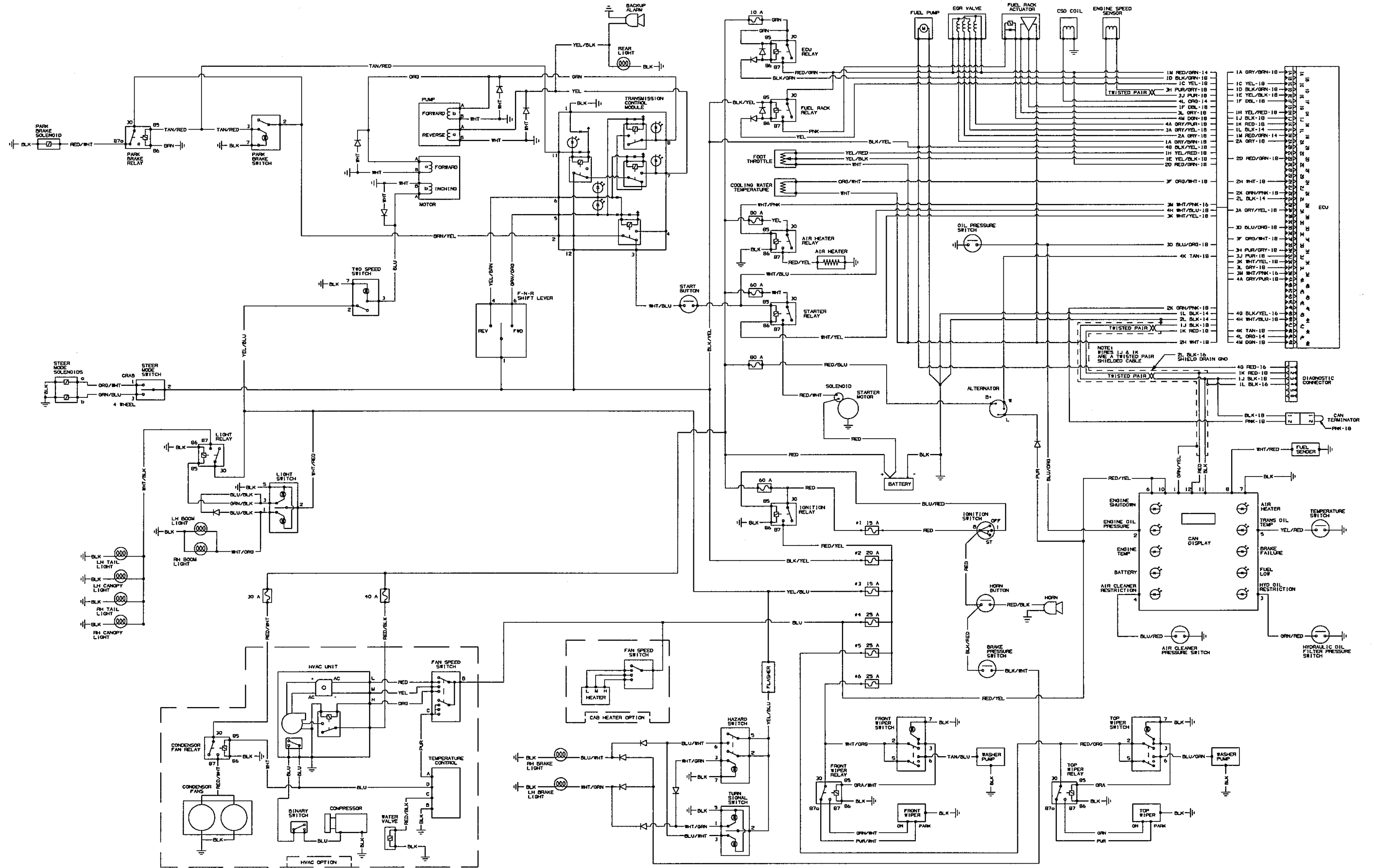

Hydraulic Schematic

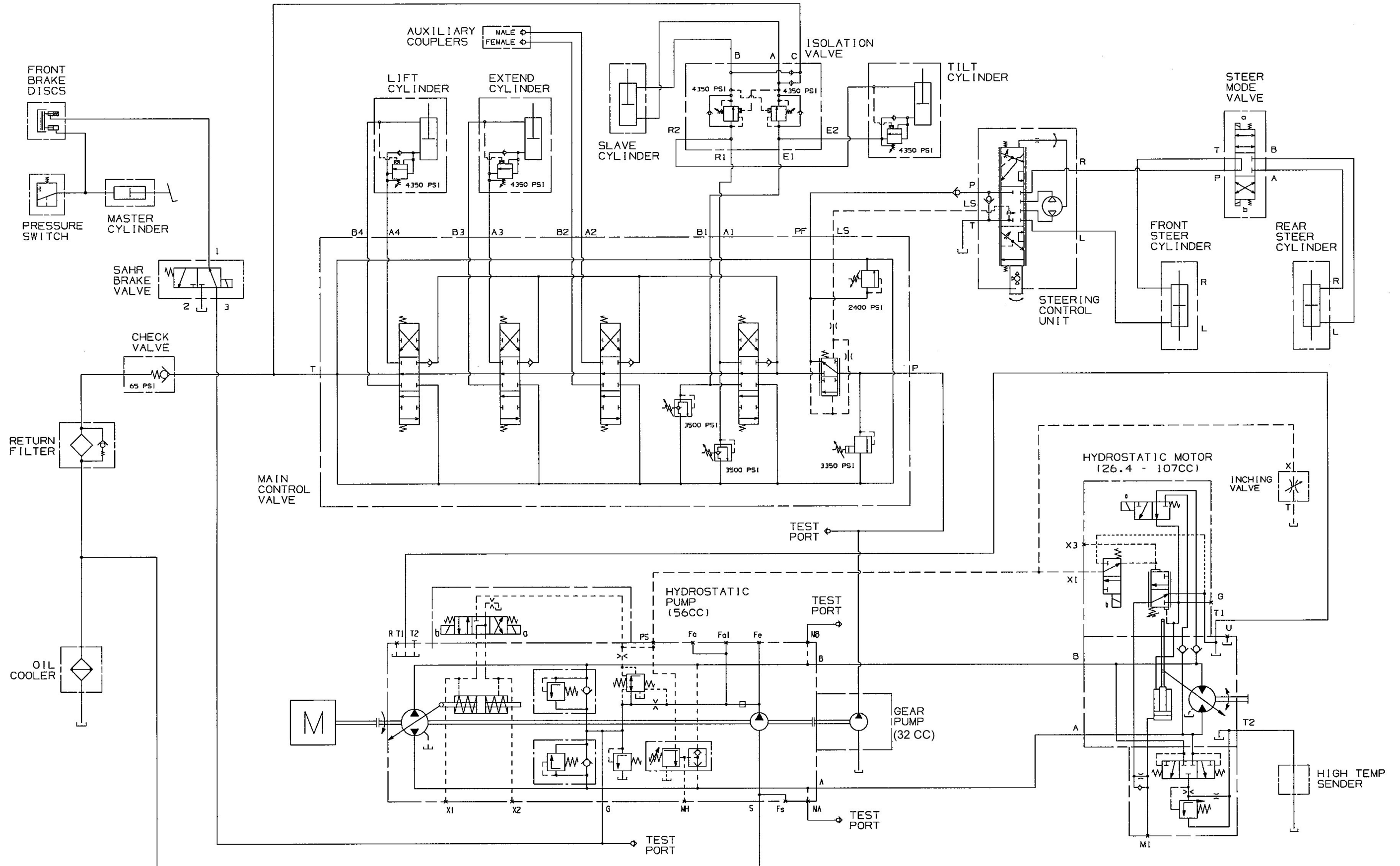

Load Zone Charts

**Standard Carriage
Decal 104399**

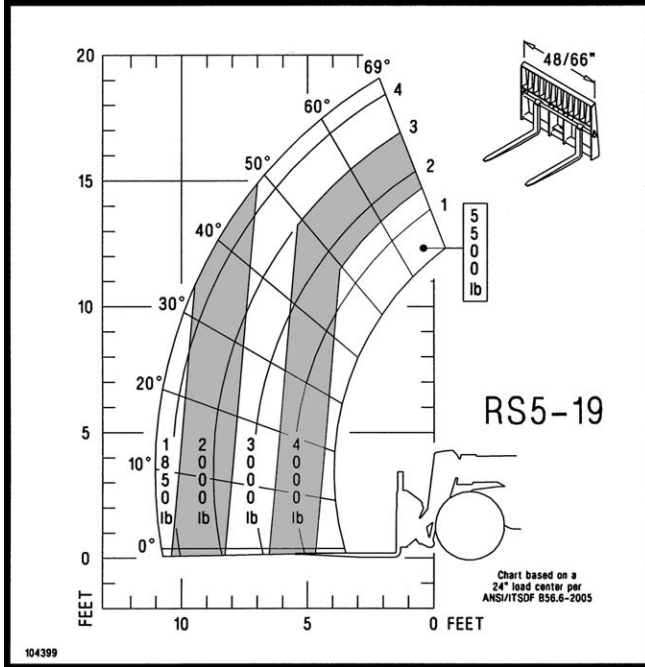

**Rotating Carriage
Decal 104400**

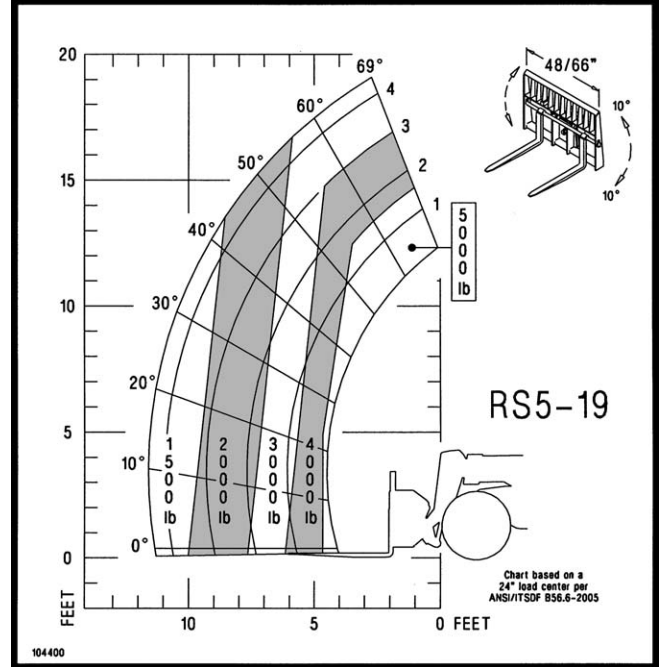

**1.0 Cu. Yd. Bucket
Decal 104401**

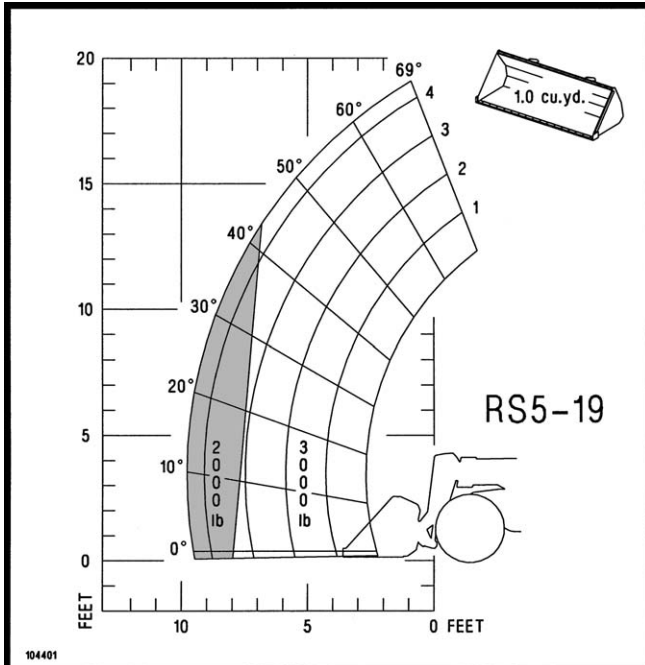

**5 Ft. Truss Boom
Decal 104402**

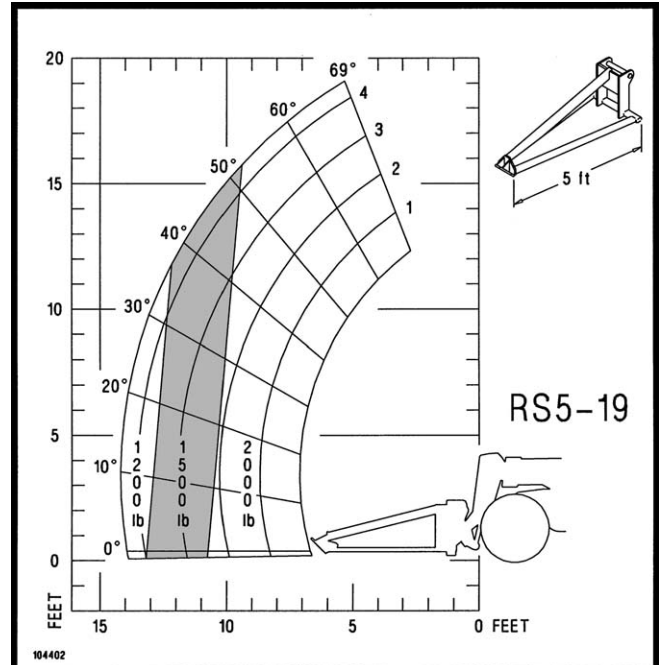

Load Zone Charts



**Fork Shift Carriage
Decal 105804**

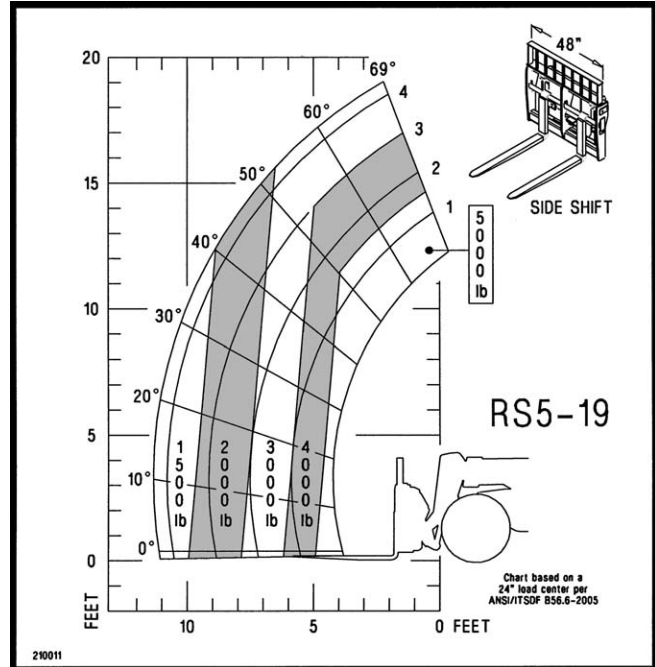
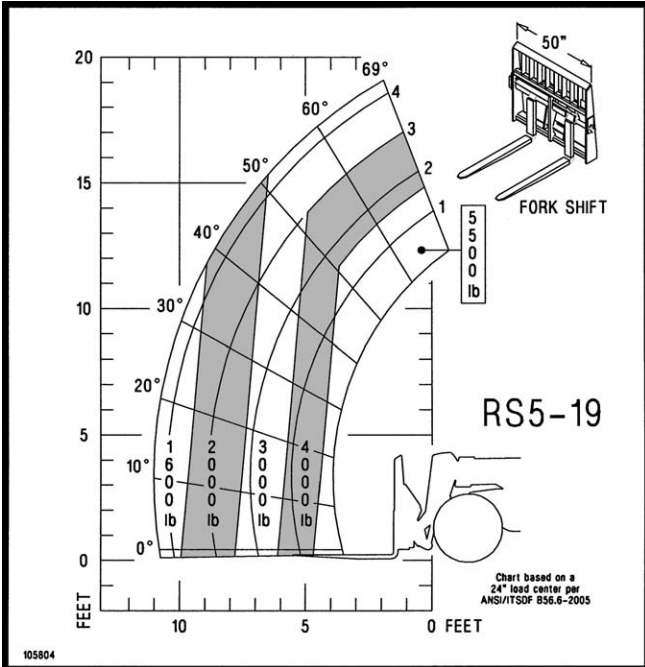

**Side Shift Carriage
Decal 210011**



Torque Specifications

Use these torque values when tightening hardware (excluding: locknuts and self-tapping, thread-forming and metal screws) unless otherwise specified.

Unified National Thread	Grade 2 		Grade 5 		Grade 8 	
	Dry	Lubed	Dry	Lubed	Dry	Lubed
8-32	19*	14*	30*	22*	41*	31*
8-36	20*	15*	31*	23*	43*	32*
10-24	27*	21*	43*	32*	60*	45*
10-32	31*	23*	49*	36*	68*	51*
1/4-20	66*	50*	9	75*	12	9
1/4-28	76*	56*	10	86*	14	10
5/16-18	11	9	17	13	25	18
5/16-24	12	9	19	14	25	20
3/8-16	20	15	30	23	45	35
3/8-24	23	17	35	25	50	35
7/16-14	32	24	50	35	70	55
7/16-20	36	27	55	40	80	60
1/2-13	35	35	75	55	110	80
1/2-20	40	40	90	65	120	90
9/16-12	55	55	110	80	150	110
9/16-18	60	60	120	90	170	130
5/8-11	75	75	150	110	220	170
5/8-18	85	85	180	130	240	180
3/4-10	130	130	260	200	380	280
3/4-16	150	150	300	220	420	320
7/8-9	125	125	430	320	600	460
7/8-14	140	140	470	360	660	500
1-8	190	190	640	480	900	680
1-14	210	210	710	530	1000	740

Metric Course Thread	Grade 8.8 		Grade 10.9 		Grade 12.9 	
	Dry	Lubed	Dry	Lubed	Dry	Lubed
M6-1	8	6	11	7	13.5	10*
24M8-1.25	19	14	27	20	32.5	24*
M10-1.5	37.5	28	53	39	64	47
M12-1.75	65	48	91.5	67.5	111.5	82
M14-2	103.5	76.5	145.5	108	176.5	131
M16-2	158.5	117.5	223.5	165.5	271	200

* All torque values are in lb-ft, except those marked with an *, which are in lb-in.
For metric torque value (Nm), multiply lb-ft x 1.355 or lb-in value x 0.113.

Index

A

Access to Components Chart	43
Accessories	25
Adjustments	
Slide Pads Clearance	50
Wheel Lug Nuts Torque	46
Air Conditioner	
Clean Condenser	51
Clean/Change Cab Ventilation Filter	51
Air Filter	
Checking and Changing Elements	52
Restriction Indicator Lamp	19
Alternator	
Belt Service	55
Indicator Lamp	19
Anti-freeze - See Radiator	
Attachment Tools	
Changing	28
Operating Methods - See Chapter 6	
Axles	
Description - See Chapter 2	
Greasing	40
See also Service	
Axle Oil	
Changing	53
Checking Levels	47
Recommended Grades	39

B

Backup Alarm	24
Battery	
Charging Lamp	19
Jump Starting	50
Servicing	49
Boom Travel	
Function Controls	22
Function Indicators	23
Servicing	50

C

Capacities - See Chapter 2	
Carriage Lifting Applications	
Picking Up the Load	33
Carrying the Load	33
Elevating and Placing the Load	33
Checklists, pre-delivery and delivery	5,7
Controls	
Dash Panel Area	18
Floor and Seat Area	22
Function Indicators	23
Right Side Panel	22
Cylinders	
Servicing	42

D

Dealer Services	42
Decals	57
Dimensions - See Chapter 2	

E

Electrical Components	
Characteristics - See Chapter 2	
Controls and Indicators - See Chapter 4	
Servicing	43
Engine	
Cold Starting	28
Description - See Chapter 2	
Diagnostic Trouble Codes	65
Oil Pressure Lamp	19
Starting	27
Temperature Gauge	19
Engine Oil	
Changing	48
Checking Level	45
Recommended Grades	39
Engine Oil Filter, replacing	48
Exhaust System, checking	55

F

Fan Belt - See Alternator Belt	
Frame Angle Indicator	.23
Fuel - See Separate Engine Manual	
Fuel Priming Procedure	.49
Fuel Filter	
Checking	.44
Draining	.47
Changing	.48
Fuel Gauge	.19
Fuse Access	.24, 25
Fuse Functions	.25

G

General Load Handling	
Load Capacity and Reach	.32
Grease Fittings	
Locations	.40
Types of Grease	.39
Guards	.17
Grade and Slope Precautions	.30
Grade Limits	.30

H

Hand Signals	.31
Hourmeter	.19
Hydraulic Components, servicing	.42
Hydraulic Oil	
Changing	.54
Checking Level	.45
Recommended Type	.39
Hydraulic Maintenance	
Oil Filters, replacing	.52
Pressure Checking	.55
Restriction Indicator Lamp	.19
Hydraulic Pump, servicing	.42
Hydraulic Valves, servicing	.42

I

Identification Reference	.3
Indicators	.19
Indicator Symbols	.Inside Front Cover
Introduction	.2

L

Lifting the Telescopic Handler	.36
Light Switch	.20
Load Zone Charts	.69
Lubrication	
<i>See also Service Intervals</i>	
Locations	.40
Lubricants	.39

M

Main Relief Pressure Check	.55
Maintenance	
Recording	.62
Scheduled Intervals	.61
Mandatory Safety Shutdown Procedure	.8

O

Oils - See Lubrication	
Operation	
Load Handling	.32
Starting	.27
Stopping	.28
Symbols	.Inside Front Cover
Travel	.35
Operator's Manual, storing	.2
Operator Services	.43
Operator's Station	
Heater Controls	.21
Heater - A/C Controls	.21

P

Parking Brake Switch	.20
Paint, refinish	.57
Pre-Start Inspection	.26
Pump, delivery rates - See Chapter 2	

Q

Quick-attach System	
Attach/Detach Mechanism	.28

R

Radiator	
Checking Coolant	.45
Checking for Debris	.45
Changing Coolant	.54
Relay Access	.24, 25
Relay Functions	.25
Road Travel	.35

S

SAFETY8
Decals13
Schematics	
Electrical67
Hydraulic68
Seat Belt22
Seat, operator's22
Service and Safety Features23
Service Intervals	
Daily44
Weekly46
New Machine47
250 hours47
500 hours52
1000 hours52
2000 hours55
Shields17
Side View Mirror24
Specifications4
Steering - See Controls	
Steering Relief Pressure Check55
Storing the Machine55
Suspended Loads34
Guidelines For Free Rigging / Suspended Loads34

T

Tables	
Lubricants39
Paint Notice57
Replacement Filters40
Theft Deterrents37
Tire Pressures46
Torque Specifications71
Towing the Telescopic Handler36
Traffic Flow Patterns31
Transmission	
Description - See Chapter 2	
Temperature Lamp19
Transporting	
Loading35
Unloading35
Travel Speed - See Controls	

W

Warranty	Inside Rear Cover
Water Trap - See Fuel Filter	
Windshield Wiper Switch21

GEHL COMPANY

WARRANTY

GEHL COMPANY, hereinafter referred to as Gehl, warrants new Gehl equipment to the Original Retail Purchaser to be free from defects in material and workmanship for a period of twelve (12) months from the Warranty Start Date.

GEHL WARRANTY SERVICE INCLUDES:

Genuine Gehl parts and labor costs required to repair or replace equipment at the selling dealer's business location.

GEHL MAKES NO REPRESENTATIONS OR WARRANTIES OF ANY KIND, EXPRESS OR IMPLIED (INCLUDING THE IMPLIED WARRANTIES OF MERCHANTABILITY AND FITNESS FOR PARTICULAR PURPOSE), EXCEPT AS EXPRESSLY STATED IN THIS WARRANTY STATEMENT.

ANY OF THESE LIMITATIONS EXCLUDED BY LOCAL LAW SHALL BE DEEMED DELETED FROM THIS WARRANTY; ALL OTHER TERMS WILL CONTINUE TO APPLY.

SOME STATES DO NOT PERMIT THE EXCLUSION OR LIMITATION OF THESE WARRANTIES AND YOU MAY HAVE GREATER RIGHTS UNDER YOUR STATE LAW.

GEHL WARRANTY DOES NOT INCLUDE:

1. Transportation to selling dealer's business location or, at the option of the Original Retail Purchaser, the cost of a service call.
2. Used equipment.
3. Components covered by their own non-Gehl warranties, such as tires, batteries, trade accessories and engines.
4. Normal maintenance service and expendable, high-wear items.
5. Repairs or adjustments caused by: improper use; failure to follow recommended maintenance procedures; use of unauthorized attachments; accident or other casualty.
6. Liability for incidental or consequential damages of any type, including, but not limited to lost profits or expenses of acquiring replacement equipment.

No agent, employee or representative of Gehl has any authority to bind Gehl to any warranty except as specifically set forth herein.

WARNING

**THIS OPERATOR'S MANUAL IS
PROVIDED FOR OPERATOR USE**

**DO NOT REMOVE
FROM THIS MACHINE**

Do not start, operate or work on this machine until you have carefully read and thoroughly understand the contents of the operator's manual.

Failure to follow safety, operating and maintenance instructions could result in serious injury to the operator or bystanders, poor operation, and costly breakdowns.

If you have any questions on proper operation, adjustment or maintenance of this machine, contact your dealer or the service department of Gehl Company before starting or continuing operation.

California Proposition 65 Warnings

Diesel engine exhaust and some of its constituents are known to the State of California to cause cancer and birth defects or other reproductive harm.

Battery posts, terminals and related accessories contain lead and lead compounds, chemicals known to the State of California to cause cancer and birth defects or other reproductive harm. **Wash hands after handling battery.**

GEHL®

Manitou Americas

P.O. Box 179, West Bend, WI 53095-0179 USA

www.gehl.com