

**MANNESMANN
DEMAG**

Demag AC 395

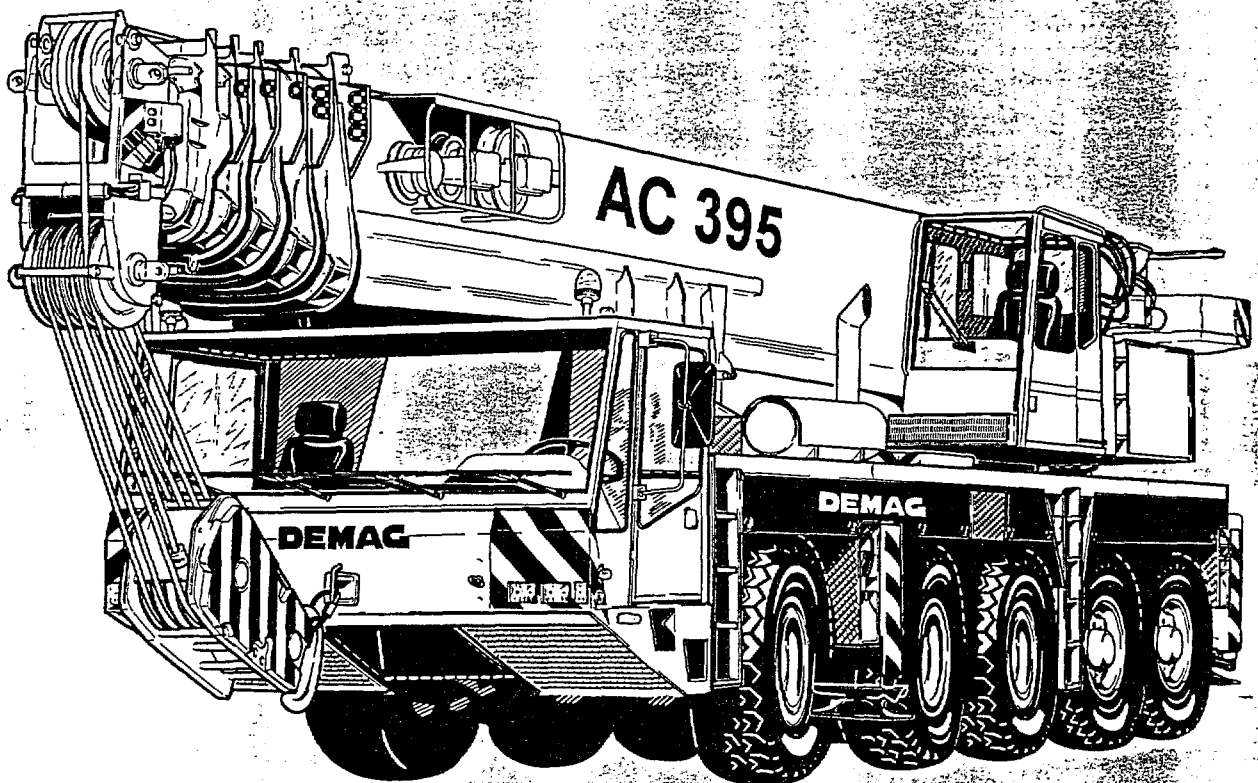

Dimensions

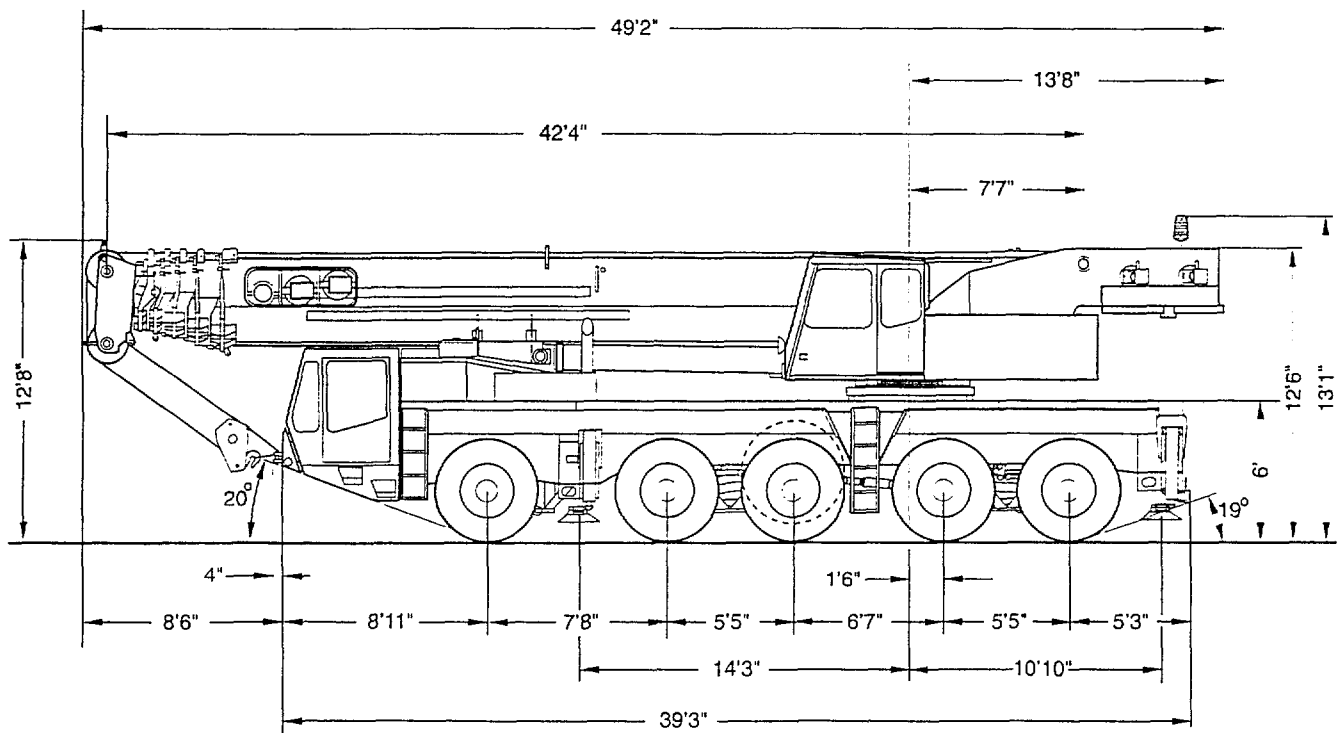

Dimensions

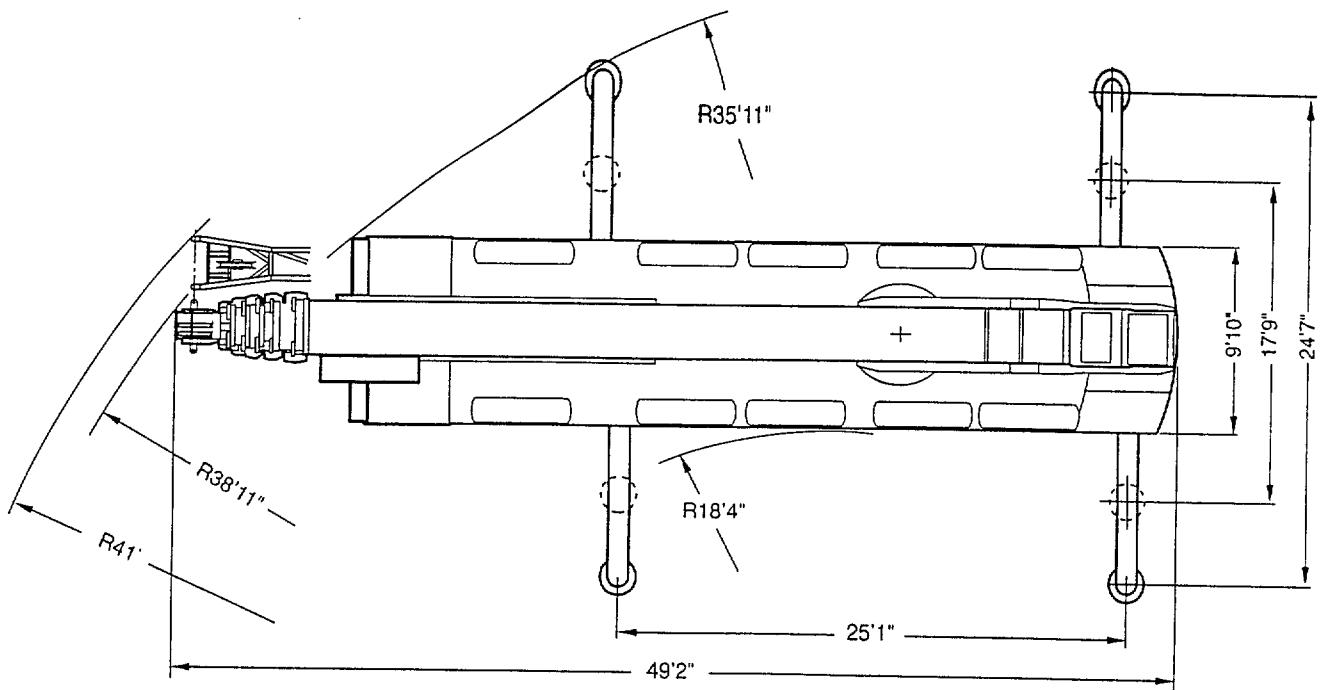
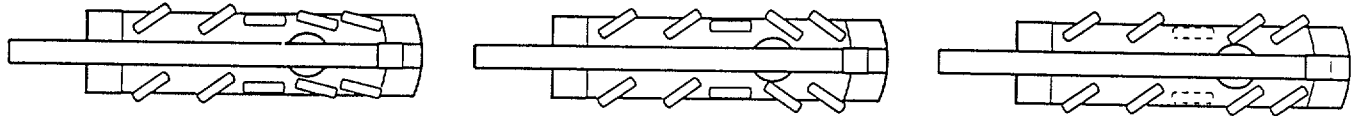

Specifications

Axle loads

Basic machine with hook block type 32,17600 lb counterweight, tires 14.00 R 25, spare wheel.

Basic machine 56 ft main boom extension, with hook block type 32,13200 lb counterweight, tires 14.00 R 25, spare wheel.

Axles	5 x 26,460 lb
Total	132,300 lb

Working speeds (infinitely variable)

Mechanisms	Normal speed	High speed	Max. permissible line pull ¹⁾	Length of hoist rope
Hoist I	197 ft/min	361 ft/min	16,000 lb	787 ft
Hoist II	197 ft/min	361 ft/min	16,000 lb	787 ft

Slewing max. 2 rpm

Telescoping speed 42-197 ft: 150 s

Boom elevation -1.5° - +80.5°: 55 s

Carrier performance

Travel speed	
Forward	0 to 46/50 mph ³⁾
Reverse	0 to 4 mph
Gradeability in travel order	max. 60%
Ground clearance	13 inches

Hook block/Single line hook

Type	Possible load ²⁾	Number of sheaves	Number of lines	Weight	"D"
125*)	132 t	9	18	2867 lb	6.6 ft
80	87 t	5	11	2051 lb	6.2 ft
63	55 t	3	7	1543 lb	6.2 ft
32	23 t	1	3	1213 lb	5.9 ft
8	8 t	Single line hook		551 lb	5.6 ft

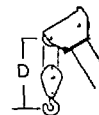

*) heavy-lift attachment is required, without heavy-lift attachment: capacity 96 tons (12 lines)

¹⁾ varies depending on national regulations



²⁾ varies depending on line pull permissible under different national regulations

³⁾ depending on tires

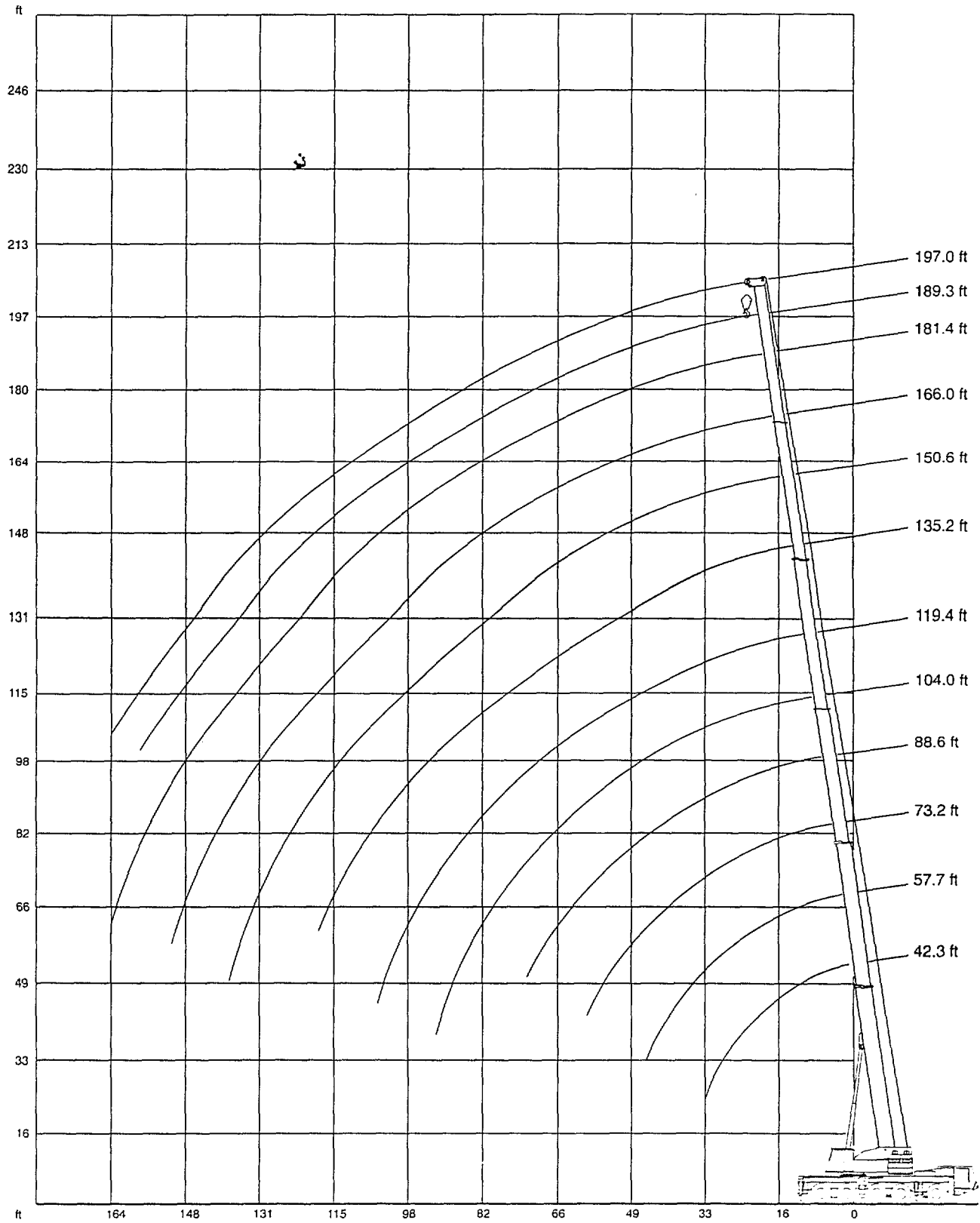
Working range main boom



Lifting capacities main boom in 1,000 lb

66,100 lb   25'1" x 24'7" 360° 85%

Radius ft	Length of main boom (ft)																		
	42.3 ft	57.7 ft	73.2 ft	88.6 ft	88.6 ft	104.0ft	104.7ft	119.4ft	135.2ft	134.8ft	150.6ft	150.6ft	166.0ft	166.0ft	181.4ft	181.4ft	189.3ft	197.0ft	
10	300.0*	-	-	-	-	-	-	-	-	-	-	-	-	-	-	-	-	-	-
10	241.4	-	-	-	-	-	-	-	-	-	-	-	-	-	-	-	-	-	-
11	234.5	169.7	-	-	-	-	-	-	-	-	-	-	-	-	-	-	-	-	-
13	213.7	169.7	121.2	-	-	-	-	-	-	-	-	-	-	-	-	-	-	-	-
15	193.9	166.0	121.2	97.0	48.5	-	-	-	-	-	-	-	-	-	-	-	-	-	-
16	185.1	160.5	121.2	97.0	48.5	72.7	48.5	-	-	-	-	-	-	-	-	-	-	-	-
19	163.0	144.3	121.2	97.0	48.5	72.7	48.5	48.5	-	-	-	-	-	-	-	-	-	-	-
23	139.5	126.2	121.1	96.9	48.5	72.7	48.4	48.5	-	-	-	-	-	-	-	-	-	-	-
26	120.8	115.5	112.2	93.5	48.5	70.9	47.8	48.5	48.5	33.9	-	-	-	-	-	-	-	-	-
29	106.1	104.6	101.7	87.7	48.5	66.3	45.8	48.5	48.5	33.9	38.1	21.8	-	-	-	-	-	-	-
33	87.7	89.4	86.8	79.5	48.4	60.3	43.0	48.4	45.9	33.9	36.5	21.8	29.7	16.9	-	-	-	-	-
39	-	68.3	65.2	64.0	45.3	52.9	39.2	46.2	41.7	33.1	34.3	21.8	28.5	16.9	21.8	16.9	-	-	-
46	-	51.4	48.6	47.7	41.1	45.3	35.4	41.6	37.4	29.2	31.2	21.8	26.4	16.9	21.8	16.9	19.3	16.9	-
52	-	-	39.1	38.2	37.5	37.4	32.0	38.4	34.2	26.4	28.6	21.8	24.6	16.9	21.2	16.7	17.5	16.7	-
59	-	-	30.9	30.0	33.9	29.3	28.9	34.6	30.6	23.6	25.5	19.8	22.2	16.9	19.4	15.2	16.3	16.0	-
65	-	-	-	24.5	30.3	23.9	26.4	31.6	28.2	21.5	23.1	18.0	20.4	16.9	18.0	14.2	15.1	15.0	-
72	-	-	-	19.3	25.6	18.6	24.0	26.5	25.2	19.4	20.7	16.5	18.5	15.4	16.5	12.8	14.1	14.1	-
79	-	-	-	-	-	14.2	21.9	22.5	22.1	17.5	18.6	14.9	16.9	14.0	15.1	11.8	12.9	12.9	-
85	-	-	-	-	-	11.3	20.7	19.5	19.1	16.5	17.2	14.1	15.9	13.0	14.3	10.6	11.9	12.1	-
92	-	-	-	-	-	8.7	18.2	16.7	16.0	15.1	16.0	12.7	14.5	12.1	12.9	9.9	10.5	11.2	-
98	-	-	-	-	-	-	-	14.4	14.0	14.5	14.0	12.1	13.7	11.3	12.1	9.0	9.5	10.4	-
105	-	-	-	-	-	-	-	12.3	11.6	13.6	11.6	11.2	11.6	10.3	11.4	8.1	8.1	9.6	-
111	-	-	-	-	-	-	-	-	10.0	11.8	10.0	10.4	10.0	9.9	10.2	7.5	7.3	8.8	-
118	-	-	-	-	-	-	-	-	8.4	10.1	8.4	9.9	8.4	9.2	8.4	6.8	6.6	7.9	-
124	-	-	-	-	-	-	-	-	-	-	7.1	9.3	7.1	8.8	7.3	6.4	6.2	7.1	-
131	-	-	-	-	-	-	-	-	-	-	5.7	8.1	5.7	7.9	6.2	5.5	5.3	6.2	-
138	-	-	-	-	-	-	-	-	-	-	4.8	7.2	4.8	7.0	4.8	5.0	4.5	4.8	-
144	-	-	-	-	-	-	-	-	-	-	-	-	4.0	6.2	4.0	4.6	3.5	4.0	-
151	-	-	-	-	-	-	-	-	-	-	-	-	-	2.8	5.0	3.0	4.1	2.6	3.0
157	-	-	-	-	-	-	-	-	-	-	-	-	-	-	-	2.2	3.5	2.0	2.2
164	-	-	-	-	-	-	-	-	-	-	-	-	-	-	-	1.5	2.8	-	1.5

Boom extension sequence %																			
Tele 1	0	0	50	75	30	100	20	44	60	40	70	40	80	50	90	50	100	100	100
Tele 2	0	50	50	75	30	100	20	44	60	40	70	40	80	50	90	100	100	100	100
Tele 3	0	0	0	0	30	0	54	54	60	73	70	90	80	100	90	100	92	100	100
Tele 4	0	0	0	0	30	0	54	54	60	73	70	90	80	100	90	100	92	100	100
Tele 5	0	0	0	0	30	0	54	54	60	73	70	90	80	100	90	100	92	100	100

*) over rear

Lifting capacities main boom in 1,000 lb

44,100 lb  25'1" x 24'7" 360° 85%



Radius ft	Length of main boom (ft)																		
	42.3 ft	57.7 ft	73.2 ft	88.6 ft	88.6 ft	104.0 ft	104.7 ft	119.4 ft	135.2 ft	134.8 ft	150.6 ft	150.6 ft	166.0 ft	166.0 ft	181.4 ft	181.4 ft	189.3 ft	197.0 ft	
10	300.0*	-	-	-	-	-	-	-	-	-	-	-	-	-	-	-	-	-	-
10	241.1	-	-	-	-	-	-	-	-	-	-	-	-	-	-	-	-	-	-
11	232.3	169.7	-	-	-	-	-	-	-	-	-	-	-	-	-	-	-	-	-
13	210.6	169.7	121.2	-	-	-	-	-	-	-	-	-	-	-	-	-	-	-	-
15	191.0	166.0	121.2	97.0	48.5	-	-	-	-	-	-	-	-	-	-	-	-	-	-
16	182.4	160.5	121.2	97.0	48.5	72.7	48.5	-	-	-	-	-	-	-	-	-	-	-	-
19	158.7	144.3	121.2	97.0	48.5	72.7	48.5	48.5	-	-	-	-	-	-	-	-	-	-	-
23	127.6	126.1	121.0	96.9	48.5	72.7	48.4	48.5	-	-	-	-	-	-	-	-	-	-	-
26	110.3	109.2	106.1	93.5	48.5	70.9	47.8	48.5	48.5	33.9	-	-	-	-	-	-	-	-	-
29	92.6	91.7	88.1	85.4	48.5	66.3	45.8	48.5	48.5	33.9	38.1	21.8	-	-	-	-	-	-	-
33	72.9	72.3	69.0	67.9	48.4	60.2	43.0	48.4	45.9	33.9	36.5	21.8	29.7	16.9	-	-	-	-	-
39	-	53.8	50.9	49.8	45.3	48.7	39.2	46.2	41.7	33.1	34.3	21.8	28.5	16.9	21.8	16.9	-	-	-
46	-	39.5	36.7	35.8	41.1	35.4	35.4	41.5	37.4	29.2	31.2	21.8	26.4	16.9	21.8	16.9	19.3	16.9	-
52	-	-	28.8	27.5	34.2	26.9	32.0	35.3	34.2	26.4	28.6	21.8	24.6	16.9	21.2	16.7	17.5	16.7	-
59	-	-	21.4	20.3	27.1	19.6	28.9	28.4	28.0	23.6	25.5	19.8	22.2	16.9	19.4	15.2	16.3	16.0	-
65	-	-	-	15.6	22.5	15.0	25.0	23.8	23.2	21.5	22.9	18.0	20.4	16.9	18.0	14.2	15.1	15.0	-
72	-	-	-	11.5	17.9	10.4	20.8	19.2	18.8	19.4	18.8	16.5	18.5	15.4	16.5	12.8	14.1	14.1	-
79	-	-	-	-	-	7.3	17.3	15.7	15.1	17.0	15.1	14.9	15.1	14.0	15.1	11.8	12.9	12.9	-
85	-	-	-	-	-	4.9	14.8	13.1	12.6	14.4	12.6	14.1	12.6	13.0	12.8	10.6	11.9	12.1	-
92	-	-	-	-	-	2.8	12.2	10.7	10.1	12.0	10.1	12.7	10.3	12.0	10.3	9.9	10.1	10.3	-
98	-	-	-	-	-	-	-	9.1	8.2	10.2	8.2	10.9	8.5	10.6	8.5	9.0	8.2	8.5	-
105	-	-	-	-	-	-	-	7.2	6.8	8.3	6.8	9.2	6.8	9.2	6.8	8.1	6.6	6.8	-
111	-	-	-	-	-	-	-	-	5.4	7.1	5.4	7.8	5.4	7.8	5.6	6.9	5.2	5.4	-
118	-	-	-	-	-	-	-	-	4.2	5.7	4.2	6.6	4.2	6.4	4.2	5.5	3.9	4.2	-
124	-	-	-	-	-	-	-	-	-	-	3.0	5.4	3.0	5.4	3.2	4.5	2.7	3.2	-
131	-	-	-	-	-	-	-	-	-	-	2.0	4.4	2.0	4.2	2.2	3.3	1.7	2.2	-
138	-	-	-	-	-	-	-	-	-	-	-	3.5	-	3.2	-	2.4	-	-	-
144	-	-	-	-	-	-	-	-	-	-	-	-	-	2.4	-	1.8	-	-	-
151	-	-	-	-	-	-	-	-	-	-	-	-	-	1.9	-	-	-	-	-

Boom extension sequence %

Tele 1	0	0	50	75	30	100	20	44	60	40	70	40	80	50	90	50	100	100
Tele 2	0	50	50	75	30	100	20	44	60	40	70	40	80	50	90	100	100	100
Tele 3	0	0	0	0	30	0	54	54	60	73	70	90	80	100	90	100	92	100
Tele 4	0	0	0	0	30	0	54	54	60	73	70	90	80	100	90	100	92	100
Tele 5	0	0	0	0	30	0	54	54	60	73	70	90	80	100	90	100	92	100

*) over rear

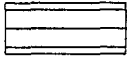
Lifting capacities main boom in 1,000 lb



17,600 lb   25'1" x 24'7" 360° 85%

Radius ft	Length of main boom (ft)																		
	42.3 ft	57.7 ft	73.2 ft	88.6 ft	88.6 ft	104.0 ft	104.7 ft	119.4 ft	135.2 ft	134.8 ft	150.6 ft	150.6 ft	166.0 ft	166.0 ft	181.4 ft	181.4 ft	189.3 ft	197.0 ft	
10	240.7	-	-	-	-	-	-	-	-	-	-	-	-	-	-	-	-	-	-
11	229.7	169.7	-	-	-	-	-	-	-	-	-	-	-	-	-	-	-	-	-
13	207.1	169.7	121.2	-	-	-	-	-	-	-	-	-	-	-	-	-	-	-	-
15	186.7	166.0	121.2	97.0	48.5	-	-	-	-	-	-	-	-	-	-	-	-	-	-
16	174.4	160.5	121.2	97.0	48.5	72.7	48.5	-	-	-	-	-	-	-	-	-	-	-	-
19	143.3	140.3	121.2	97.0	48.5	72.7	48.5	48.5	-	-	-	-	-	-	-	-	-	-	-
23	106.6	105.5	101.3	96.7	48.5	72.7	48.4	48.5	-	-	-	-	-	-	-	-	-	-	-
26	82.8	81.9	77.9	76.6	48.5	70.9	47.8	48.5	48.5	33.9	-	-	-	-	-	-	-	-	-
29	66.8	65.7	62.0	60.9	48.5	59.6	45.8	48.5	48.5	33.9	38.1	21.8	-	-	-	-	-	-	-
33	50.8	50.0	46.5	45.6	48.2	44.7	43.0	48.2	45.8	33.9	36.5	21.8	29.7	16.9	-	-	-	-	-
39	-	35.3	32.1	31.3	38.7	30.4	39.2	39.9	39.4	33.1	34.3	21.8	28.5	16.9	21.8	16.9	-	-	-
46	-	24.5	21.3	20.2	27.9	19.3	30.7	29.2	28.8	29.2	28.8	21.8	26.4	16.9	21.8	16.9	19.3	16.9	-
52	-	-	14.8	13.5	21.4	12.8	24.5	23.0	22.3	24.2	22.5	21.8	22.1	16.9	21.2	16.7	17.5	16.7	-
59	-	-	9.3	8.1	15.4	7.5	18.7	17.0	16.5	18.7	16.5	19.4	16.5	16.9	16.5	15.2	15.8	15.8	-
65	-	-	-	4.9	12.0	3.9	14.9	13.1	12.7	14.7	12.7	15.6	12.9	15.3	12.9	14.2	12.2	12.2	-
72	-	-	-	1.8	8.4	-	11.5	9.7	9.3	11.3	9.3	11.9	9.3	11.9	9.5	11.3	9.1	9.1	-
79	-	-	-	-	-	-	8.9	7.1	6.7	8.7	6.7	9.3	6.7	9.3	6.9	8.3	6.5	6.7	-
85	-	-	-	-	-	-	6.9	5.3	4.7	6.7	4.9	7.3	4.9	7.3	5.1	6.6	4.7	4.9	-
92	-	-	-	-	-	-	5.2	3.5	3.0	4.8	3.0	5.4	3.0	5.4	3.2	4.8	2.8	3.0	-
98	-	-	-	-	-	-	-	2.2	1.8	3.4	1.8	4.2	1.8	4.2	2.0	3.4	1.6	2.0	-
105	-	-	-	-	-	-	-	-	-	2.2	-	2.8	-	2.8	-	2.2	-	-	-
111	-	-	-	-	-	-	-	-	-	-	-	2.0	-	1.8	-	-	-	-	-

Boom extension sequence %

Tele 1	0	0	50	75	30	100	20	44	60	40	70	40	80	50	90	50	100	100
Tele 2	0	50	50	75	30	100	20	44	60	40	70	40	80	50	90	100	100	100
Tele 3	0	0	0	0	30	0	54	54	60	73	70	90	80	100	90	100	92	100
Tele 4	0	0	0	0	30	0	54	54	60	73	70	90	80	100	90	100	92	100
Tele 5	0	0	0	0	30	0	54	54	60	73	70	90	80	100	90	100	92	100

Lifting capacities main boom in 1,000 lb



13,200 lb   25'1" x 24'7" 360° 85%

Radius ft	Length of main boom (ft)																		
	42.3 ft	57.7 ft	73.2 ft	88.6 ft	88.6 ft	104.0 ft	104.7 ft	119.4 ft	135.2 ft	134.8 ft	150.6 ft	150.6 ft	166.0 ft	166.0 ft	181.4 ft	181.4 ft	189.3 ft	197.0 ft	
10	240.6	-	-	-	-	-	-	-	-	-	-	-	-	-	-	-	-	-	-
11	229.1	169.7	-	-	-	-	-	-	-	-	-	-	-	-	-	-	-	-	-
13	206.2	169.7	121.2	-	-	-	-	-	-	-	-	-	-	-	-	-	-	-	-
15	185.2	166.0	121.2	97.0	48.5	-	-	-	-	-	-	-	-	-	-	-	-	-	-
16	171.5	160.5	121.2	97.0	48.5	72.7	48.5	-	-	-	-	-	-	-	-	-	-	-	-
19	140.3	138.0	121.2	97.0	48.5	72.7	48.5	48.5	-	-	-	-	-	-	-	-	-	-	-
23	99.8	98.7	94.3	93.0	48.5	72.7	48.4	48.5	-	-	-	-	-	-	-	-	-	-	-
26	77.4	76.5	72.5	71.4	48.5	69.0	47.8	48.5	48.5	33.9	-	-	-	-	-	-	-	-	-
29	61.5	60.6	56.8	55.7	48.5	54.7	45.8	48.5	48.5	33.9	38.1	21.8	-	-	-	-	-	-	-
33	46.5	45.6	42.3	41.2	48.0	40.5	43.0	48.1	45.7	33.9	36.5	21.8	29.7	16.9	-	-	-	-	-
39	-	32.1	29.0	27.7	35.3	27.0	38.4	37.0	36.3	33.1	34.3	21.8	28.5	16.9	21.8	16.9	-	-	-
46	-	21.5	18.2	16.9	25.0	16.2	28.1	26.6	26.1	28.1	26.1	21.8	25.7	16.9	21.7	16.9	19.3	16.9	-
52	-	-	12.1	10.8	18.8	10.2	22.1	20.3	19.7	21.9	19.9	21.8	19.6	16.9	18.9	16.7	17.5	16.7	-
59	-	-	7.0	5.7	13.2	5.1	16.5	14.8	14.1	16.3	14.3	17.2	14.3	16.9	13.9	15.2	13.0	13.2	-
65	-	-	-	2.7	10.0	2.0	12.9	11.1	10.7	12.7	10.7	13.6	10.7	13.5	10.6	12.4	10.0	10.2	-
72	-	-	-	-	6.9	-	9.7	8.0	7.5	9.5	7.5	10.2	7.5	10.2	7.7	9.3	7.1	7.1	-
79	-	-	-	-	-	-	7.1	5.6	4.9	6.9	5.0	7.6	5.2	7.6	5.2	6.9	4.7	4.7	-
85	-	-	-	-	-	-	5.3	4.0	3.1	5.1	3.3	5.8	3.3	5.8	3.6	5.1	3.1	3.1	-
92	-	-	-	-	-	-	3.9	2.1	1.7	3.5	1.7	4.3	1.7	4.3	1.9	3.2	1.7	1.7	-
98	-	-	-	-	-	-	-	-	-	2.2	-	2.9	-	2.9	-	2.2	-	-	-
105	-	-	-	-	-	-	-	-	-	-	-	1.7	-	1.7	-	-	-	-	-

Boom extension sequence %

Tele 1	0	0	50	75	30	100	20	44	60	40	70	40	80	50	90	50	100	100
Tele 2	0	50	50	75	30	100	20	44	60	40	70	40	80	50	90	100	100	100
Tele 3	0	0	0	0	30	0	54	54	60	73	70	90	80	100	90	100	92	100
Tele 4	0	0	0	0	30	0	54	54	60	73	70	90	80	100	90	100	92	100
Tele 5	0	0	0	0	30	0	54	54	60	73	70	90	80	100	90	100	92	100

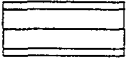
Lifting capacities main boom in 1,000 lb

0 lb   25'1" x 24'7" 360° 85%



Radius ft	Main boom (ft)				
	42.3 ft	57.7 ft	73.2 ft	88.6 ft	88.6 ft
10	218.6	-	-	-	-
11	207.0	154.3	-	-	-
13	186.0	154.3	110.2	-	-
15	157.7	150.4	110.2	88.1	44.0
16	146.2	143.4	110.2	88.1	44.0
19	104.2	103.3	93.6	88.0	44.0
23	65.5	64.6	60.6	59.5	44.0
26	48.7	47.9	44.5	43.6	44.0
29	37.9	37.0	34.1	33.0	39.6
33	27.9	27.0	23.9	23.0	30.5
39	-	17.5	14.8	14.0	20.6
46	-	10.7	8.3	7.4	13.6
52	-	-	4.0	3.2	9.7
59	-	-	-	-	6.4
65	-	-	-	-	3.9

Boom extension sequence %

Tele 1	0	0	50	75	30
Tele 2	0	50	50	75	30
Tele 3	0	0	0	0	30
Tele 4	0	0	0	0	30
Tele 5	0	0	0	0	30

Lifting capacities main boom in 1,000 lb

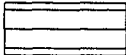
Special boom extension sequence

17,600 lb   25'1" x 24'7" 360° 85%



Radius ft	Main boom (ft)						
	73.2 ft	88.6 ft	104.4 ft	119.8 ft	135.2 ft	150.6 ft	166.0 ft
13	48.5	-	-	-	-	-	-
15	48.5	48.5	-	-	-	-	-
16	48.5	48.5	43.6	-	-	-	-
19	48.5	48.5	43.6	26.6	-	-	-
23	47.5	48.5	43.6	26.6	16.9	-	-
26	44.7	48.5	41.6	26.6	16.9	16.9	-
29	42.1	47.0	38.4	26.6	16.9	16.9	-
33	39.1	42.5	34.2	26.6	16.9	16.9	16.9
39	35.0	36.7	29.4	26.4	16.9	16.9	16.9
46	31.4	31.6	25.1	22.6	16.9	16.9	16.9
52	25.0	26.2	22.2	20.0	16.9	16.9	16.9
59	19.4	20.7	20.0	17.4	16.9	16.9	15.8
65	-	16.9	17.6	16.0	15.3	15.3	14.6
72	-	13.3	14.2	14.3	13.9	13.9	13.0
79	-	-	11.5	12.0	12.4	11.3	10.2
85	-	-	9.5	10.0	10.6	9.3	8.2
92	-	-	7.6	8.1	8.7	7.4	6.5
98	-	-	-	6.9	7.3	6.2	5.1
105	-	-	-	5.5	6.1	4.8	3.9
111	-	-	-	-	4.9	3.6	2.7
118	-	-	-	-	3.9	2.6	1.7
124	-	-	-	-	-	2.0	-

Boom extension sequence %

Tele 1	0	0	0	0	0	0	0
Tele 2	0	0	0	0	0	50	100
Tele 3	33	50	67	83	100	100	100
Tele 4	33	50	67	83	100	100	100
Tele 5	33	50	67	83	100	100	100

Lifting capacities main boom in 1,000 lb

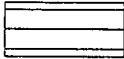
Special boom extension sequence

13,200 lb   25'1" x 24'7" 360° 85%

Radius ft	Main boom (ft)						
	73.2 ft	88.6 ft	104.4 ft	119.8 ft	135.2 ft	150.6 ft	166.0 ft
13	48.5	-	-	-	-	-	-
15	48.5	48.5	-	-	-	-	-
16	48.5	48.5	43.6	-	-	-	-
19	48.5	48.5	43.6	26.6	-	-	-
23	47.5	48.5	43.6	26.6	16.9	-	-
26	44.7	48.5	41.6	26.6	16.9	16.9	-
29	42.1	47.0	38.4	26.6	16.9	16.9	-
33	39.1	42.5	34.2	26.6	16.9	16.9	16.9
39	35.0	36.7	29.4	26.4	16.9	16.9	16.9
46	28.8	29.9	25.1	22.6	16.9	16.9	16.9
52	22.5	23.8	22.2	20.0	16.9	16.9	16.9
59	17.0	18.5	19.2	17.4	16.9	16.9	15.8
65	-	14.9	15.7	16.0	15.3	15.3	14.4
72	-	11.7	12.4	13.0	13.7	12.4	11.3
79	-	-	9.8	10.2	11.1	9.8	8.7
85	-	-	8.0	8.4	9.3	8.0	6.9
92	-	-	6.5	7.0	7.4	6.3	5.0
98	-	-	-	5.6	6.2	4.9	4.0
105	-	-	-	4.4	4.8	3.5	2.6
111	-	-	-	-	4.0	2.7	-
118	-	-	-	-	2.8	-	-

Boom extension sequence %

Tele 1	0	0	0	0	0	0	0
Tele 2	0	0	0	0	0	50	100
Tele 3	33	50	67	83	100	100	100
Tele 4	33	50	67	83	100	100	100
Tele 5	33	50	67	83	100	100	100

Lifting capacities main boom in 1,000 lb

66,100 lb



25'1" x 17'9" 360°



85%

Radius ft	Main boom (ft)																	
	42.3 ft	57.7 ft	73.2 ft	88.6 ft	88.6 ft	104.0 ft	104.7 ft	119.4 ft	135.2 ft	134.8 ft	150.6 ft	150.6 ft	166.0 ft	166.0 ft	181.4 ft	181.4 ft	189.3 ft	197.0 ft
	1,000 lb																	
10	235.4	-	-	-	-	-	-	-	-	-	-	-	-	-	-	-	-	-
11	221.6	169.7	-	-	-	-	-	-	-	-	-	-	-	-	-	-	-	-
13	197.2	169.7	121.2	-	-	-	-	-	-	-	-	-	-	-	-	-	-	-
15	177.6	166.0	121.2	97.0	48.5	-	-	-	-	-	-	-	-	-	-	-	-	-
16	169.0	160.5	121.2	97.0	48.5	72.7	48.5	-	-	-	-	-	-	-	-	-	-	-
19	145.1	142.7	121.2	97.0	48.5	72.7	48.5	48.5	-	-	-	-	-	-	-	-	-	-
23	103.8	102.9	99.6	96.8	48.5	72.7	48.4	48.5	-	-	-	-	-	-	-	-	-	-
26	83.6	82.5	79.6	78.6	48.5	70.9	47.8	48.5	48.5	33.9	-	-	-	-	-	-	-	-
29	69.2	68.3	65.6	64.7	48.5	63.3	45.8	48.5	48.5	33.9	38.1	21.8	-	-	-	-	-	-
33	55.3	54.6	52.0	51.1	48.3	50.5	43.0	48.3	45.9	33.9	36.5	21.8	29.7	16.9	-	-	-	-
39	-	41.1	38.7	37.8	43.3	37.4	39.2	44.5	41.7	33.1	34.3	21.8	28.5	19.9	21.8	16.9	-	-
46	-	30.7	28.3	27.4	33.2	27.0	35.4	34.3	33.8	29.2	31.2	21.8	26.4	16.9	21.8	16.9	19.3	16.9
52	-	-	22.3	21.6	26.9	21.2	29.3	28.0	27.6	26.4	27.4	21.8	24.6	16.9	21.2	16.7	17.5	16.7
59	-	-	17.0	16.3	21.4	15.9	23.6	22.5	22.0	23.6	22.0	19.8	22.0	16.9	19.4	15.2	16.3	16.0
65	-	-	-	12.9	17.9	12.4	19.9	19.0	18.6	19.9	18.6	18.0	18.6	16.9	18.0	14.2	15.1	15.0
72	-	-	-	9.7	14.6	9.1	16.6	15.5	15.0	16.6	15.0	16.5	15.0	15.4	15.2	12.8	14.1	14.1
79	-	-	-	-	-	6.0	14.0	12.7	12.4	14.0	12.4	14.4	12.4	14.0	12.7	11.8	12.4	12.7
85	-	-	-	-	-	4.0	12.2	10.8	10.4	12.0	10.4	12.4	10.4	12.4	10.6	10.6	10.4	10.6
92	-	-	-	-	-	1.9	10.3	9.2	8.7	10.1	8.7	10.5	8.7	10.5	9.0	9.8	8.7	9.0
98	-	-	-	-	-	-	-	7.8	7.3	8.4	7.3	9.3	7.3	9.3	7.5	8.4	7.3	7.5
105	-	-	-	-	-	-	-	6.3	5.7	7.2	5.7	7.7	5.7	7.7	6.1	7.2	5.5	6.1
111	-	-	-	-	-	-	-	-	4.7	6.4	4.7	6.9	4.7	6.9	4.7	6.2	4.5	4.7
118	-	-	-	-	-	-	-	-	3.3	5.0	3.3	5.5	3.3	5.5	3.3	4.8	3.1	3.3
124	-	-	-	-	-	-	-	-	-	2.5	4.7	2.3	4.7	2.5	3.6	2.2	2.5	
131	-	-	-	-	-	-	-	-	-	1.5	3.5	1.5	3.5	1.5	2.8	-	1.5	
138	-	-	-	-	-	-	-	-	-	-	2.8	-	2.6	-	1.9	-	-	

Boom extension sequence %

Tele 1	0	0	50	75	30	100	20	44	60	40	70	40	80	50	90	50	100	100
Tele 2	0	50	50	75	30	100	20	44	60	40	70	40	80	50	90	100	100	100
Tele 3	0	0	0	0	30	0	54	54	60	73	70	90	80	100	90	100	92	100
Tele 4	0	0	0	0	30	0	54	54	60	73	70	90	80	100	90	100	92	100
Tele 5	0	0	0	0	30	0	54	54	60	73	70	90	80	100	90	100	92	100

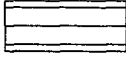
Lifting capacities main boom in 1,000 lb

44,100 lb   25'1" x 17'9" 360° 85%



Radius ft	Main boom (ft)																	
	42.3 ft	57.7 ft	73.2 ft	88.6 ft	88.6 ft	104.0 ft	104.7 ft	119.4 ft	135.2 ft	134.8 ft	150.6 ft	150.6 ft	166.0 ft	166.0 ft	181.4 ft	181.4 ft	189.3 ft	197.0 ft
	1,000 lb																	
10	230.0	-	-	-	-	-	-	-	-	-	-	-	-	-	-	-	-	-
11	216.4	169.7	-	-	-	-	-	-	-	-	-	-	-	-	-	-	-	-
13	192.5	169.7	121.2	-	-	-	-	-	-	-	-	-	-	-	-	-	-	-
15	172.9	165.9	121.2	97.0	48.5	-	-	-	-	-	-	-	-	-	-	-	-	-
16	163.1	160.3	121.2	97.0	48.5	72.7	48.5	-	-	-	-	-	-	-	-	-	-	-
19	119.5	118.6	108.0	97.0	48.5	72.7	48.5	48.5	-	-	-	-	-	-	-	-	-	-
23	80.5	79.6	76.1	75.2	48.5	72.5	48.4	48.5	-	-	-	-	-	-	-	-	-	-
26	64.3	63.5	60.3	59.5	48.5	58.6	47.8	48.5	48.5	33.9	-	-	-	-	-	-	-	-
29	52.8	51.9	49.0	48.2	48.5	47.7	45.8	48.5	48.5	33.9	38.1	21.8	-	-	-	-	-	-
33	41.5	40.8	38.2	37.5	43.9	36.9	42.9	45.4	44.8	33.9	36.4	21.8	29.7	16.9	-	-	-	-
39	-	29.9	27.5	26.8	32.8	26.4	35.0	34.2	33.7	33.1	33.2	21.8	28.5	16.9	21.8	16.9	-	-
46	-	21.7	19.5	18.6	24.1	18.2	26.6	25.5	24.8	26.6	25.0	21.8	25.0	16.9	21.8	16.9	19.3	16.9
52	-	-	14.7	14.0	19.3	13.4	21.5	20.2	20.0	21.5	20.0	21.6	20.0	16.9	19.9	16.7	17.5	16.7
59	-	-	10.3	9.7	14.8	9.0	17.0	16.1	15.4	17.0	15.4	17.4	15.4	16.9	15.9	15.2	15.4	15.8
65	-	-	-	6.7	12.1	5.8	14.1	13.0	12.6	14.1	12.6	14.6	12.6	14.5	12.8	14.0	12.6	12.8
72	-	-	-	3.3	9.5	2.7	11.5	10.2	9.9	11.3	9.9	11.9	9.9	11.9	10.2	11.3	9.9	10.2
79	-	-	-	-	-	-	9.4	8.0	7.6	9.1	7.6	9.6	7.8	9.6	7.8	9.1	7.6	7.8
85	-	-	-	-	-	-	7.7	6.6	6.2	7.5	6.2	8.0	6.2	8.0	6.4	7.5	6.2	6.4
92	-	-	-	-	-	-	6.3	4.8	4.3	6.1	4.3	6.5	4.3	6.5	4.5	6.1	4.3	4.5
98	-	-	-	-	-	-	-	3.4	2.9	4.7	2.9	5.3	2.9	5.3	3.1	4.7	2.9	3.1
105	-	-	-	-	-	-	-	2.2	1.7	3.3	1.7	4.1	1.7	4.1	1.9	3.0	1.5	1.9
111	-	-	-	-	-	-	-	-	-	2.4	-	2.9	-	2.9	-	2.2	-	-
118	-	-	-	-	-	-	-	-	-	1.5	-	1.9	-	1.9	-	-	-	-

Boom extension sequence %

Tele 1	0	0	50	75	30	100	20	44	60	40	70	40	80	50	90	50	100	100
Tele 2	0	50	50	75	30	100	20	44	60	40	70	40	80	50	90	100	100	100
Tele 3	0	0	0	0	30	0	54	54	60	73	70	90	80	100	90	100	92	100
Tele 4	0	0	0	0	30	0	54	54	60	73	70	90	80	100	90	100	92	100
Tele 5	0	0	0	0	30	0	54	54	60	73	70	90	80	100	90	100	92	100

Lifting capacities main boom in 1,000 lb

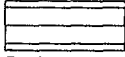
Special boom extension sequence

17,600 lb   25'1" x 17'9" 360° 85%



Radius ft	Main boom (ft)						
	73.2 ft	88.6 ft	104.4 ft	119.8 ft	135.2 ft	150.6 ft	166.0 ft
13	48.5	-	-	-	-	-	-
15	48.5	48.5	-	-	-	-	-
16	48.5	48.5	43.6	-	-	-	-
19	48.5	48.5	43.6	26.6	-	-	-
23	47.5	48.5	43.6	26.6	16.9	-	-
26	44.7	48.5	41.6	26.6	16.9	16.9	-
29	39.3	41.1	38.4	26.6	16.9	16.9	-
33	31.4	32.8	33.6	26.6	16.9	16.9	16.9
39	23.2	24.5	25.2	25.2	16.9	16.9	16.9
46	16.9	17.8	18.6	19.1	16.9	16.9	16.9
52	13.1	14.1	14.8	15.3	15.5	14.7	14.1
59	9.9	10.8	11.7	11.9	12.5	11.7	10.6
65	-	8.6	9.4	9.9	10.3	9.4	8.5
72	-	6.8	7.3	7.7	8.2	7.3	6.6
79	-	-	5.6	6.3	6.7	5.6	4.7
85	-	-	4.6	5.1	5.3	4.4	3.3
92	-	-	3.2	3.5	4.3	3.0	-
98	-	-	-	2.7	3.1	-	-

Boom extension sequence %

Tele 1	0	0	0	0	0	0	0
Tele 2	0	0	0	0	0	50	100
Tele 3	33	50	67	83	100	100	100
Tele 4	33	50	67	83	100	100	100
Tele 5	33	50	67	83	100	100	100

Lifting capacities main boom in 1,000 lb

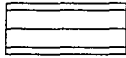
Special boom extension sequence

13,200 lb   25'1" x 17'9" 360° 85%

Radius ft	Main boom (ft)						
	73.2 ft	88.6 ft	104.4 ft	119.8 ft	135.2 ft	150.6 ft	166.0 ft
13	48.5	-	-	-	-	-	-
15	48.5	48.5	-	-	-	-	-
16	48.5	48.5	43.6	-	-	-	-
19	48.5	48.5	43.6	26.6	-	-	-
23	47.5	48.4	43.6	26.6	16.9	-	-
26	43.9	45.4	41.6	26.6	16.9	16.9	-
29	36.4	37.9	37.9	26.6	16.9	16.9	-
33	28.6	30.1	30.8	26.5	16.9	16.9	16.9
39	21.1	22.1	22.9	23.1	16.9	16.9	16.9
46	15.1	16.2	16.9	17.3	16.9	16.9	16.0
52	11.7	12.6	13.3	13.9	14.3	13.3	12.4
59	8.4	9.5	10.1	10.6	11.2	10.1	9.5
65	-	7.4	8.1	8.5	9.2	8.1	7.4
72	-	5.5	6.4	6.8	7.3	6.4	5.3
79	-	-	4.7	5.2	5.6	4.5	3.4
85	-	-	3.3	4.0	4.6	3.3	-
92	-	-	2.4	2.6	3.2	-	-

Boom extension sequence %

Tele 1	0	0	0	0	0	0	0
Tele 2	0	0	0	0	0	50	100
Tele 3	33	50	67	83	100	100	100
Tele 4	33	50	67	83	100	100	100
Tele 5	33	50	67	83	100	100	100

Working range main boom extension

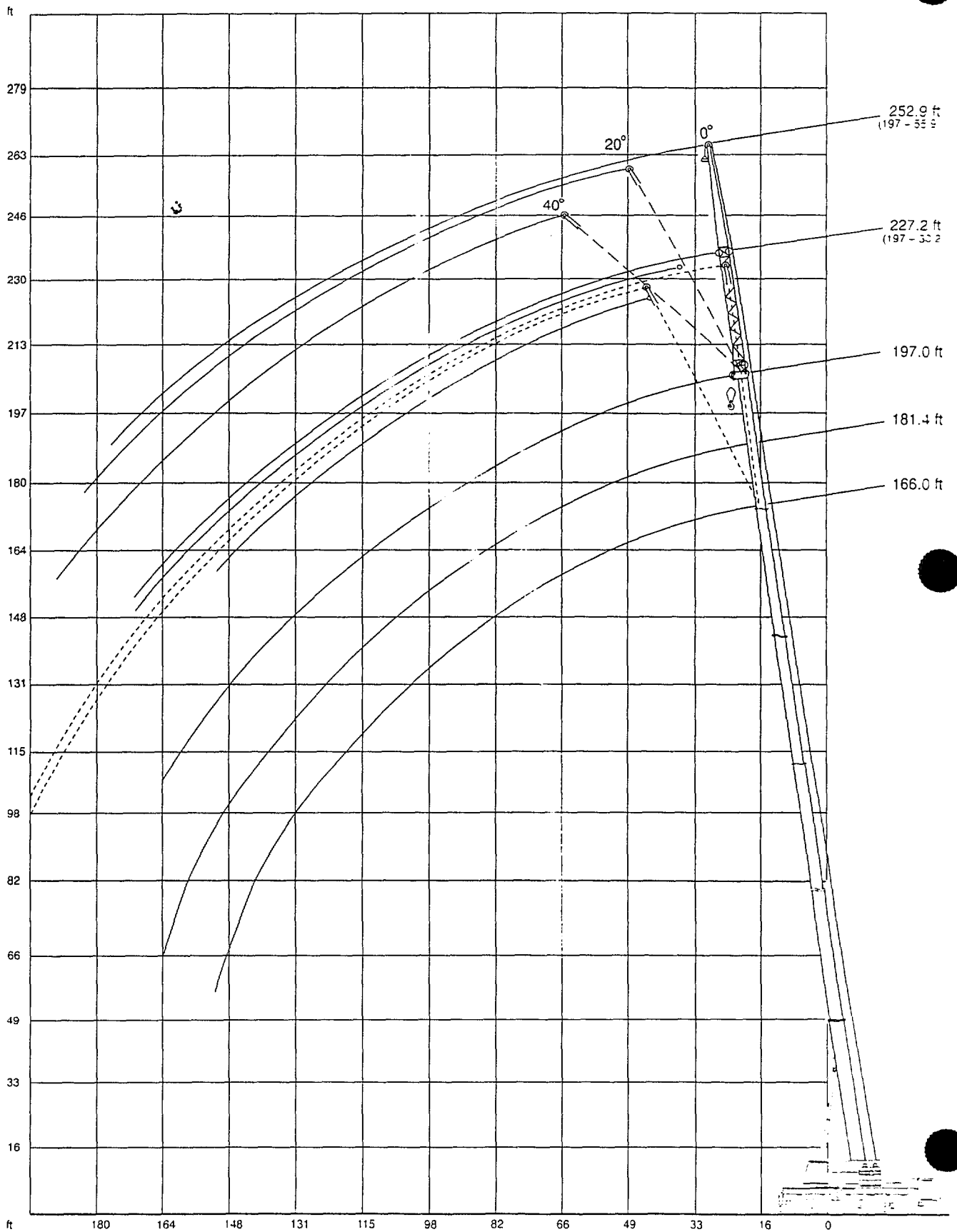



Lifting capacities main boom extension in 1,000 lb

Main boom: 166.0 ft

66,100 lb   25'1"x24'7" 360° 85%



Radius ft	Extension					
	30.2 ft			55.9 ft		
	0°	20°	40°	0°	20°	40°
	1,000 lb					
46	14.5	-	-	-	-	-
52	14.5	-	-	7.2	-	-
59	14.1	12.1	9.9	7.2	-	-
65	13.3	12.1	9.9	7.2	5.7	-
72	12.7	11.9	9.9	7.2	5.7	-
79	12.1	11.6	9.6	7.0	5.7	5.2
85	11.7	11.4	9.4	6.8	5.5	5.2
92	10.7	10.7	9.2	6.8	5.2	5.0
98	10.3	10.3	9.2	6.6	5.0	5.0
105	9.9	10.1	9.0	6.3	5.0	4.8
111	9.5	9.7	8.4	6.1	4.8	4.8
118	9.0	9.2	8.1	6.1	4.8	4.8
124	8.2	8.8	7.9	5.7	4.6	4.6
131	7.0	7.7	7.5	5.5	4.6	4.6
138	5.7	6.5	6.8	5.2	4.4	4.6
144	4.8	5.5	-	5.0	4.4	4.4
151	4.1	4.6	-	4.8	4.4	4.4
157	3.1	3.6	-	4.2	4.4	4.4
164	2.2	2.6	-	3.3	4.1	4.4
170	1.6	2.0	-	2.7	3.3	-
177	-	-	-	2.0	2.6	-
184	-	-	-	1.5	1.9	-

Main boom: 197.0 ft

66,100 lb   25'1"x24'7" 360° 85%

Radius ft	Extension					
	30.2 ft			55.9 ft		
	0°	20°	40°	0°	20°	40°
	1,000 lb					
46	-	-	-	-	-	-
52	7.7	-	-	-	-	-
59	7.7	-	-	3.5	-	-
65	7.7	-	-	3.5	-	-
72	7.7	6.1	6.3	3.5	-	-
79	7.7	6.1	6.3	3.5	2.4	-
85	7.5	6.1	6.3	3.5	2.4	-
92	7.2	6.1	6.3	3.5	2.4	2.4
98	6.8	6.1	6.3	3.5	2.4	2.4
105	6.6	6.1	6.3	3.5	2.4	2.4
111	6.4	6.1	6.3	3.5	2.4	2.4
118	6.1	6.1	6.3	3.5	2.4	2.4
124	5.5	6.1	6.1	3.5	2.4	2.4
131	5.2	6.1	5.5	3.5	2.4	2.4
138	5.0	5.4	5.0	3.5	2.4	2.4
144	4.6	4.8	4.6	3.5	2.4	2.4
151	3.5	4.3	3.9	3.5	2.4	2.4
157	2.9	3.3	-	3.3	2.4	2.4
164	2.2	2.6	-	2.6	2.4	2.4
170	1.6	2.0	-	2.0	2.4	2.4
177	-	-	-	1.5	2.2	2.4
184	-	-	-	-	1.7	-

Main boom: 181.4 ft

66,100 lb   25'1"x24'7" 360° 85%

Radius ft	Extension					
	30.2 ft			55.9 ft		
	0°	20°	40°	0°	20°	40°
	1,000 lb					
46	11.2	-	-	-	-	-
52	11.2	-	-	4.8	-	-
59	11.2	-	-	4.8	-	-
65	10.8	9.7	9.7	4.8	-	-
72	10.3	9.4	9.7	4.8	4.4	-
79	10.1	9.2	9.4	4.8	4.4	-
85	9.7	9.0	9.2	4.8	4.4	4.4
92	9.2	8.8	9.0	4.8	4.4	4.4
98	9.0	8.4	8.8	4.8	4.4	4.4
105	8.3	8.1	8.3	4.6	4.4	4.4
111	7.9	7.7	7.9	4.6	4.4	4.4
118	7.5	7.4	7.7	4.6	4.4	4.4
124	7.2	7.1	7.3	4.6	4.4	4.4
131	6.8	6.8	6.8	4.4	4.4	4.4
138	5.4	6.3	6.3	4.4	4.4	4.4
144	4.6	5.3	5.5	4.4	4.4	4.4
151	3.9	4.3	4.6	4.1	4.1	4.4
157	2.9	3.5	-	3.5	3.9	4.2
164	2.2	2.6	-	2.8	3.9	3.9
170	1.6	2.0	-	2.2	3.1	3.5
177	-	-	-	1.7	2.4	-
184	-	-	-	-	1.9	-

Lifting capacities main boom extension in 1,000 lb

Main boom: 166.0 ft

44,100 lb  25'1"x24'7" 360° 85%

Radius	Extension					
	30.2 ft			55.9 ft		
	0°	20°	40°	0°	20°	40°
ft	1,000 lb					
46	14.5	-	-	-	-	-
52	14.5	-	-	7.2	-	-
59	14.1	12.1	9.9	7.2	-	-
65	13.3	12.1	9.9	7.2	5.7	-
72	12.7	11.9	9.9	7.2	5.7	-
79	12.1	11.6	9.6	7.0	5.7	5.2
85	11.7	11.4	9.4	6.8	5.5	5.2
92	10.7	10.7	9.2	6.8	5.2	5.0
98	9.7	10.3	9.2	6.6	5.0	5.0
105	7.9	9.2	9.0	6.3	5.0	4.8
111	6.7	7.6	8.2	6.1	4.8	4.8
118	5.3	6.1	6.8	6.1	4.8	4.8
124	4.3	4.9	5.6	5.1	4.6	4.6
131	3.1	4.0	4.4	4.0	4.6	4.6
138	2.1	2.8	3.0	3.0	4.3	4.6
144	1.5	2.0	-	2.2	3.3	4.4
151	-	-	-	1.5	2.6	3.2
157	-	-	-	-	2.0	2.4
164	-	-	-	-	-	1.7

Main boom: 197.0 ft

44,100 lb  25'1"x24'7" 360° 85%

Radius	Extension					
	30.2 ft			55.9 ft		
	0°	20°	40°	0°	20°	40°
ft	1,000 lb					
46	-	-	-	-	-	-
52	7.7	-	-	-	-	-
59	7.7	-	-	3.5	-	-
65	7.7	-	-	3.5	-	-
72	7.7	6.1	6.3	3.5	-	-
79	7.7	6.1	6.3	3.5	2.4	-
85	7.5	6.1	6.3	3.5	2.4	-
92	7.2	6.1	6.3	3.5	2.4	2.4
98	6.8	6.1	6.3	3.5	2.4	2.4
105	6.6	6.1	6.3	3.5	2.4	2.4
111	6.2	6.1	6.3	3.5	2.4	2.4
118	4.8	5.7	6.3	3.5	2.4	2.4
124	3.6	4.7	5.4	3.5	2.4	2.4
131	2.6	3.5	4.2	3.3	2.4	2.4
138	1.9	2.6	3.0	2.4	2.4	2.4
144	-	1.8	2.2	1.8	2.4	2.4
151	-	-	-	-	2.1	2.4
157	-	-	-	-	1.5	2.2
164	-	-	-	-	-	1.5

Main boom: 181.4 ft

44,100 lb  25'1"x24'7" 360° 85%

Radius	Extension					
	30.2 ft			55.9 ft		
	0°	20°	40°	0°	20°	40°
ft	1,000 lb					
46	11.2	-	-	-	-	-
52	11.2	-	-	4.8	-	-
59	11.2	-	-	4.8	-	-
65	10.8	9.7	9.7	4.8	-	-
72	10.3	9.4	9.7	4.8	4.4	-
79	10.1	9.2	9.4	4.8	4.4	-
85	9.7	9.0	9.2	4.8	4.4	4.4
92	9.2	8.8	9.0	4.8	4.4	4.4
98	9.0	8.4	8.8	4.8	4.4	4.4
105	7.7	8.1	8.3	4.6	4.4	4.4
111	6.5	7.5	7.9	4.6	4.4	4.4
118	5.0	6.1	6.8	4.6	4.4	4.4
124	4.0	4.9	5.4	4.6	4.4	4.4
131	2.9	3.5	4.2	3.5	4.4	4.4
138	1.9	2.6	3.0	2.6	4.1	4.4
144	-	2.0	2.2	2.0	3.1	4.2
151	-	-	1.5	-	2.4	3.0
157	-	-	-	-	1.8	2.4
164	-	-	-	-	-	1.5

Lifting capacities main boom extension in 1,000 lb

Main boom: 166.0 ft

17,600 lb  25'1"x24'7" 360° 85%

Radius ft	Extension					
	30.2 ft			55.9 ft		
	0°	20°	40°	0°	20°	40°
	1,000 lb					
46	14.5	-	-	-	-	-
52	14.5	-	-	7.2	-	-
59	14.1	12.1	9.9	7.2	-	-
65	13.3	12.1	9.9	7.2	5.7	-
72	10.8	11.9	9.9	7.2	5.7	-
79	8.3	10.0	9.6	7.0	5.7	5.2
85	6.4	8.0	9.2	6.8	5.5	5.2
92	4.5	6.1	7.0	5.4	5.2	5.0
98	3.1	4.5	5.4	4.2	5.0	5.0
105	1.9	2.8	3.9	2.8	4.8	4.8
111	-	1.8	2.5	1.8	3.6	4.8
118	-	-	1.5	-	2.4	3.9
124	-	-	-	-	1.6	2.7
131	-	-	-	-	-	1.7

Main boom: 197.0 ft

17,600 lb  25'1"x24'7" 360° 85%

Radius ft	Extension					
	30.2 ft			55.9 ft		
	0°	20°	40°	0°	20°	40°
	1,000 lb					
46	-	-	-	-	-	-
52	7.7	-	-	-	-	-
59	7.7	-	-	3.5	-	-
65	7.7	-	-	3.5	-	-
72	7.7	6.1	6.3	3.5	-	-
79	7.1	6.1	6.3	3.5	2.4	-
85	5.3	6.1	6.3	3.5	2.4	-
92	3.5	5.0	6.3	3.5	2.4	2.4
98	2.2	3.6	4.9	2.7	2.4	2.4
105	-	2.4	3.3	1.5	2.4	2.4
111	-	-	2.2	-	2.4	2.4
118	-	-	-	-	1.7	2.4
124	-	-	-	-	-	2.2
131	-	-	-	-	-	-



Main boom: 181.4 ft

17,600 lb  25'1"x24'7" 360° 85%

Radius ft	Extension					
	30.2 ft			55.9 ft		
	0°	20°	40°	0°	20°	40°
	1,000 lb					
46	11.2	-	-	-	-	-
52	11.2	-	-	4.8	-	-
59	11.2	-	-	4.8	-	-
65	10.8	9.7	9.7	4.8	-	-
72	10.1	9.4	9.7	4.8	4.4	-
79	7.6	9.1	9.4	4.8	4.4	-
85	5.8	7.5	8.8	4.8	4.4	4.4
92	4.1	5.4	6.7	4.8	4.4	4.4
98	2.9	4.2	5.1	3.4	4.4	4.4
105	1.7	2.8	3.5	2.2	4.4	4.4
111	-	1.8	2.5	-	3.1	4.4
118	-	-	-	-	2.2	3.5
124	-	-	-	-	-	2.5
131	-	-	-	-	-	1.5



Lifting capacities main boom extension in 1,000 lb

Main boom: 166.0 ft

13,200 lb   25'1"x24'7" 360° 85%



Radius	Extension					
	30.2 ft			55.9 ft		
	0°	20°	40°	0°	20°	40°
ft	1,000 lb					
46	14.5	-	-	-	-	-
52	14.5	-	-	7.2	-	-
59	14.1	12.1	9.9	7.2	-	-
65	12.1	12.1	9.9	7.2	5.7	-
72	9.1	11.2	9.9	7.2	5.7	-
79	6.7	8.3	9.6	6.9	5.7	5.2
85	4.9	6.6	7.8	5.5	5.5	5.2
92	3.0	4.5	5.7	4.1	5.2	5.0
98	2.0	3.1	4.2	2.7	5.0	5.0
105	-	1.9	2.6	-	3.5	4.8
111	-	-	-	-	2.5	4.2
118	-	-	-	-	-	2.8
124	-	-	-	-	-	1.8

Main boom: 197.0 ft

13,200 lb   25'1"x24'7" 360° 85%

Radius	Extension					
	30.2 ft			55.9 ft		
	0°	20°	40°	0°	20°	40°
ft	1,000 lb					
46	-	-	-	-	-	-
52	7.7	-	-	-	-	-
59	7.7	-	-	3.5	-	-
65	7.7	-	-	3.5	-	-
72	7.5	6.1	6.3	3.5	-	-
79	5.2	6.1	6.3	3.5	2.4	-
85	3.6	5.3	6.3	3.5	2.4	-
92	2.1	3.5	4.8	2.6	2.4	2.4
98	-	2.2	3.4	-	2.4	2.4
105	-	-	2.2	-	2.4	2.4
111	-	-	-	-	-	2.4
118	-	-	-	-	-	2.2
124	-	-	-	-	-	-

Main boom: 181.4 ft

13,200 lb   25'1"x24'7" 360° 85%

Radius	Extension					
	30.2 ft			55.9 ft		
	0°	20°	40°	0°	20°	40°
ft	1,000 lb					
46	11.2	-	-	-	-	-
52	11.2	-	-	4.8	-	-
59	11.2	-	-	4.8	-	-
65	10.8	9.7	9.7	4.8	-	-
72	8.2	9.4	9.7	4.8	4.4	-
79	6.1	7.8	9.3	4.8	4.4	-
85	4.4	5.8	7.3	4.8	4.4	4.4
92	2.6	4.1	5.2	3.2	4.4	4.4
98	-	2.7	4.0	2.2	4.4	4.4
105	-	-	2.4	-	3.0	4.4
111	-	-	-	-	2.0	3.6
118	-	-	-	-	-	2.4

Lifting capacities main boom extension in 1,000 lb

Main boom: 166.0 ft

66,100 lb  25'1"x17'9" 360° 85%

Radius ft	Extension					
	30.2 ft			55.9 ft		
	0°	20°	40°	0°	20°	40°
	1,000 lb					
46	14.5	-	-	-	-	-
52	14.5	-	-	7.2	-	-
59	14.1	12.1	9.9	7.2	-	-
65	13.3	12.1	9.9	7.2	5.7	-
72	12.7	11.9	9.9	7.2	5.7	-
79	12.1	11.6	9.6	7.0	5.7	5.2
85	11.7	11.4	9.4	6.8	5.5	5.2
92	9.6	10.5	9.2	6.8	5.2	5.0
98	8.2	9.3	9.2	6.6	5.0	5.0
105	7.0	7.7	8.1	6.3	5.0	4.8
111	5.6	6.7	7.1	6.1	4.8	4.8
118	4.4	5.3	5.7	5.3	4.8	4.8
124	3.4	4.3	4.7	4.5	4.6	4.6
131	2.4	3.1	3.5	3.3	4.6	4.6
138	1.7	2.1	2.3	2.4	3.5	4.5
144	-	1.5	-	1.8	2.9	3.5
151	-	-	-	-	1.9	2.6
157	-	-	-	-	-	2.0

Main boom: 197.0 ft

66,100 lb  25'1"x17'9" 360° 85%

Radius ft	Extension					
	30.2 ft			55.9 ft		
	0°	20°	40°	0°	20°	40°
	1,000 lb					
46	-	-	-	-	-	-
52	7.7	-	-	-	-	-
59	7.7	-	-	3.5	-	-
65	7.7	-	-	3.5	-	-
72	7.7	6.1	6.3	3.5	-	-
79	7.7	6.1	6.3	3.5	2.4	-
85	7.5	6.1	6.3	3.5	2.4	-
92	7.2	6.1	6.3	3.5	2.4	2.4
98	6.8	6.1	6.3	3.5	2.4	2.4
105	6.6	6.1	6.3	3.5	2.4	2.4
111	5.4	6.1	6.3	3.5	2.4	2.4
118	4.2	5.0	5.7	3.5	2.4	2.4
124	3.2	4.0	4.7	3.5	2.4	2.4
131	2.2	2.9	3.3	2.6	2.4	2.4
138	-	1.9	2.1	1.9	2.4	2.4
144	-	-	1.5	-	2.4	2.4
151	-	-	-	-	1.7	2.4
157	-	-	-	-	-	1.8

Main boom: 181.4 ft

66,100 lb  25'1"x17'9" 360° 85%

Radius ft	Extension					
	30.2 ft			55.9 ft		
	0°	20°	40°	0°	20°	40°
	1,000 lb					
46	11.2	-	-	-	-	-
52	11.2	-	-	4.8	-	-
59	11.2	-	-	4.8	-	-
65	10.8	9.7	9.7	4.8	-	-
72	10.3	9.4	9.7	4.8	4.4	-
79	10.1	9.2	9.4	4.8	4.4	-
85	9.7	9.0	9.2	4.8	4.4	4.4
92	9.2	8.8	9.0	4.8	4.4	4.4
98	8.0	8.4	8.8	4.8	4.4	4.4
105	6.8	7.7	8.1	4.6	4.4	4.4
111	5.6	6.7	7.1	4.6	4.4	4.4
118	4.4	5.3	5.7	4.6	4.4	4.4
124	3.2	4.3	4.7	4.0	4.4	4.4
131	2.2	3.1	3.5	2.9	4.4	4.4
138	1.5	2.1	2.4	2.1	3.5	4.3
144	-	-	1.8	1.5	2.6	3.5
151	-	-	-	-	1.9	2.6
157	-	-	-	-	-	2.0

Lifting capacities main boom extension in 1,000 lb

Main boom: 166.0 ft

44,100 lb  25'1"x17'9" 360° 85%

Radius	Extension					
	30.2 ft			55.9 ft		
	0°	20°	40°	0°	20°	40°
ft	1,000 lb					
46	14.5	-	-	-	-	-
52	14.5	-	-	7.2	-	-
59	14.1	12.1	9.9	7.2	-	-
65	13.3	12.1	9.9	7.2	5.7	-
72	10.8	11.9	9.9	7.2	5.7	-
79	8.9	10.0	9.6	7.0	5.7	5.2
85	7.3	8.2	9.2	6.8	5.5	5.2
92	5.4	6.8	7.4	6.5	5.2	5.0
98	4.2	5.3	6.2	5.1	5.0	5.0
105	2.8	3.9	4.8	3.9	5.0	4.8
111	2.0	2.7	3.4	2.7	4.6	4.8
118	-	1.7	2.4	1.7	3.3	4.6
124	-	-	-	-	2.5	3.6
131	-	-	-	-	1.5	2.4
138	-	-	-	-	-	1.7

Main boom: 197.0 ft

44,100 lb  25'1"x17'9" 360° 85%

Radius	Extension					
	30.2 ft			55.9 ft		
	0°	20°	40°	0°	20°	40°
ft	1,000 lb					
46	-	-	-	-	-	-
52	7.7	-	-	-	-	-
59	7.7	-	-	3.5	-	-
65	7.7	-	-	3.5	-	-
72	7.7	6.1	6.3	3.5	-	-
79	7.6	6.1	6.3	3.5	2.4	-
85	6.6	6.1	6.3	3.5	2.4	-
92	5.0	6.1	6.3	3.5	2.4	2.4
98	3.6	4.9	6.1	3.5	2.4	2.4
105	2.4	3.5	4.6	2.8	2.4	2.4
111	1.6	2.5	3.4	1.8	2.4	2.4
118	-	1.5	2.2	-	2.4	2.4
124	-	-	-	-	1.8	2.4
131	-	-	-	-	-	2.2
138	-	-	-	-	-	-

Main boom: 181.4 ft

44,100 lb  25'1"x17'9" 360° 85%

Radius	Extension					
	30.2 ft			55.9 ft		
	0°	20°	40°	0°	20°	40°
ft	1,000 lb					
46	11.2	-	-	-	-	-
52	11.2	-	-	4.8	-	-
59	11.2	-	-	4.8	-	-
65	10.8	9.7	9.7	4.8	-	-
72	10.3	9.4	9.7	4.8	4.4	-
79	8.7	9.2	9.4	4.8	4.4	-
85	7.1	8.2	9.2	4.8	4.4	4.4
92	5.4	6.8	7.4	4.8	4.4	4.4
98	4.0	5.3	6.2	4.6	4.4	4.4
105	2.6	3.9	4.6	3.3	4.4	4.4
111	1.8	2.7	3.4	2.4	4.4	4.4
118	-	1.7	2.2	1.5	3.1	4.4
124	-	-	-	-	2.2	3.4
131	-	-	-	-	-	2.4
138	-	-	-	-	-	1.5

Lifting capacities main boom extension in 1,000 lb

Special boom sequence

Main boom: 166.0 ft

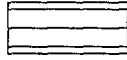

 25'1" x 24'7" 360°

85%

Radius	Extension							
	66,100 lb	44,100 lb	17,600 lb	13,200 lb	66,100 lb	44,100 lb	17,600 lb	13,200 lb
	0°				20°			
ft	55.9 ft							
52	5.0	5.0	5.0	5.0	-	-	-	-
59	5.0	5.0	5.0	5.0	-	-	-	-
65	4.8	4.8	4.8	4.8	5.2	5.2	5.2	5.2
72	4.6	4.6	4.6	4.6	5.2	5.2	5.2	5.2
79	4.6	4.6	4.6	4.6	5.0	5.0	5.0	5.0
85	4.4	4.4	4.4	4.4	4.8	4.8	4.8	4.8
92	4.1	4.1	4.1	4.1	4.8	4.8	4.8	4.8
98	4.1	4.1	4.1	4.1	4.8	4.8	4.8	4.8
105	3.9	3.9	3.9	3.3	4.6	4.6	4.6	4.6
111	3.9	3.9	3.3	2.4	4.6	4.6	4.6	4.0
118	3.5	3.5	2.4	-	4.6	4.6	3.9	2.8
124	3.5	3.5	-	-	4.6	4.6	2.9	2.0
131	3.5	3.5	-	-	4.4	4.4	2.2	-
138	3.5	3.5	-	-	4.4	4.4	-	-
144	3.3	3.3	-	-	4.2	4.2	-	-
151	3.3	3.0	-	-	4.1	4.1	-	-
157	3.3	2.4	-	-	3.9	3.3	-	-
164	3.3	1.7	-	-	3.5	2.6	-	-
170	3.3	-	-	-	3.5	2.0	-	-
177	3.0	-	-	-	3.3	-	-	-
184	2.8	-	-	-	3.0	-	-	-
190	2.4	-	-	-	2.6	-	-	-
197	1.9	-	-	-	-	-	-	-

Lifting capacities main boom extension in 1,000 lb

Special boom sequence

Main boom: 166.0 ft

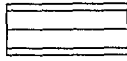

25'1" x 17'9" 360°

85%

Radius	Extension							
	66,100 lb	44,100 lb	17,600 lb	13,200 lb	66,100 lb	44,100 lb	17,600 lb	13,200 lb
	0°				20°			
ft	55.9 ft							
52	5.0	5.0	-	-	-	-	-	-
59	5.0	5.0	-	-	-	-	-	-
65	4.8	4.8	-	-	5.2	5.2	-	-
72	4.6	4.6	-	-	5.2	5.2	-	-
79	4.6	4.6	-	-	5.0	5.0	-	-
85	4.4	4.4	-	-	4.8	4.8	-	-
92	4.1	4.1	-	-	4.8	4.8	-	-
98	4.1	4.1	-	-	4.8	4.8	-	-
105	3.9	3.9	-	-	4.6	4.6	-	-
111	3.9	3.9	-	-	4.6	4.6	-	-
118	3.5	3.3	-	-	4.6	4.6	-	-
124	3.5	2.5	-	-	4.6	3.6	-	-
131	3.5	1.7	-	-	4.4	2.8	-	-
138	3.5	-	-	-	4.4	2.1	-	-
144	3.1	-	-	-	4.2	-	-	-
151	2.4	-	-	-	3.2	-	-	-
157	2.0	-	-	-	2.6	-	-	-
164	-	-	-	-	2.2	-	-	-

Notes to lifting capacity

Lifting capacities do not exceed 85% of tipping load.

Weight of hook blocks and slings are part of the load, and are to be deducted from the capacity ratings.

Crane operation is permissible up to a
wind speed of 32 ft/s

Consult operation manual for further details on wind speed.

All capacities above the parting line are based on structural strength. Capacities below the parting line are based on machine stability.

Crane operation is subject to computer charts, only!

For crane operations consult operation manual first!

Carrier	
Drive/steering	10 x 6 x 8
Frame	Monobox main frame with outrigger boxes integral, of high-strength fine grain structural steel.
Outriggers	Four hydraulically telescoping outrigger beams with hydraulic jack legs.
Engine	Mercedes Benz OM 442 LA water-cooled 8-cylinder engine (EURO I), output to DIN: 370 kW (503 hp) at 2100 rpm, max. torque 2020 Nm at 1100-1600 rpm. Fuel tank capacity: 132 gallons.
Transmission	ZF Transmatik system (14 ranges), transfer case with longitudinal differential lockout control.
Axles	Axle 1: steering; axle 2: with planetary hubs, steering, transverse differential lockout control; axle 3: rigid axle, non-steer; axle 4: with planetary hubs, steering, longitudinal and transverse differential lockout control; axle 5: with planetary hubs, steering, transverse differential lockout control.
Suspension	Hydropneumatic suspension, all axles hydraulically blockable.
Wheels and tires	10 wheels 9.5-25 fitted with 14.00 R 25 tires, on-road tread, tubeless. Single wheels on all axles.
Steering	ZF dual-circuit semiblock mechanical steering with hydraulic booster.
Brakes	Service brake: dual-line air system, acting on all wheels. Parking brake: spring-loaded type. Sustained action brake: constant decompression with butterfly valve, exhaust brake and hydraulic retarder.
Electrical equipment	24 V system
Driver's cab	Rubber-mounted all steel driver's cab with safety glazing, slide-by side windows, controls and instrumentation, driver's and passenger seat, vertically adjustable steering wheel, heated outside mirrors, rotaflare warning light.

Superstructure

Engine	Mercedes Benz OM 366 A water-cooled 6-cylinder in-line engine (Euro I), output 112 kW at 2200 rpm, max. torque 540 Nm at 1400 rpm, fuel tank capacity: 53 gallons.
Hydraulic system	one variable displacement axial piston pump and one fixed displacement pump to provide four simultaneous, independent working movements, which are controlled through a compact block.
Hoist	Fixed displacement axial piston hydraulic motor, hoist drum with integral planetary gear reducer and spring-applied holding brake, equipped with ratchet-and-pawl.
Stew unit	Hydraulic motor with planetary gear reducer, pedal-operated brake and spring-applied holding brake.
Boom elevation	One differential cylinder with pilot-controlled lowering brake valve.
Crane cab	Spacious all-steel comfortable cab with sliding door and large hinged windscreen, roof window of armoured glass, full instrumentation and crane controls, working light. Hot water heater operated either self-contained or engine-dependent, with engine preheating and 7-day programmable timer, thermostat-controlled. Window washer and intermittent control type window wiper.
Main boom	Boom base and five telescopic sections, fabricated from fine grain structural steel, telescoping ability with partial load, buckling-resistant Demag ovaloid design.
Counterweight	44,000 lb, self-removable.
Safety devices	Electronic safe load indicator with digital readout for hook load, rated load, boom length, boom angle, load radius, analog display to indicate the capacity utilization, limit switches on hoist and lowering motions, pressure-relief and safety holding valves.
Hydraulic servo control	Hydraulic pilot control through self-centering control levers.

Optional equipment

Drive/steering	10 x 8 x 8
Wheels and tires	16.00 R 25 on 11.25-25 rims; 20.5 R 25 on 17.00-25 rims.
Tow coupling	D-value 26,400 lb, air-brake connection.
Hoist II	Fixed displacement axial piston hydraulic motor, hoist drum with integral planetary gear reducer and spring-applied holding brake, equipped with ratchet-and-pawl. The use of hoist II avoids re-reeving the hoist line when using the optional jib.
Main boom extension	Side-folding 1 or 2-part jib, 30.2 ft or 55.9 ft. 0, 20 and 40 degree offset.
Additional counterweight	22,000 lb, integrates into standard counterweight, installed hydraulically by the crane itself.
Heavy-lift attachment	Additional sheaves on boom head for duties over 96 tons.