

**Demag TC 3200**

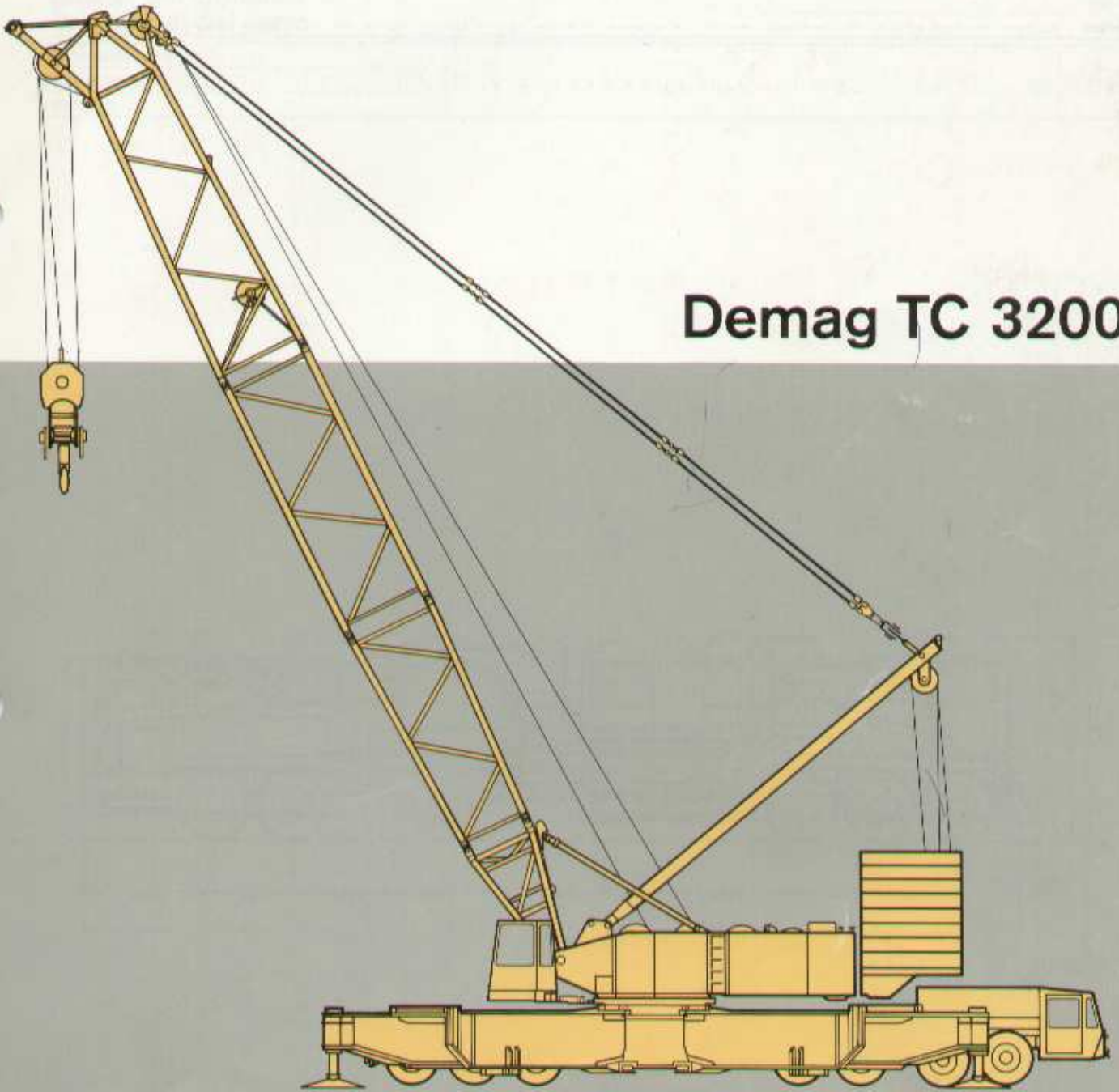

# Technische Daten Specifications Dati tecnici

## Achslasten Axle loads Carico sugli assi

Gewicht pro Achse	
Single axle load	max. 12000 kg
Peso per asse	
Gesamt	
Total	83800 kg
Totale	

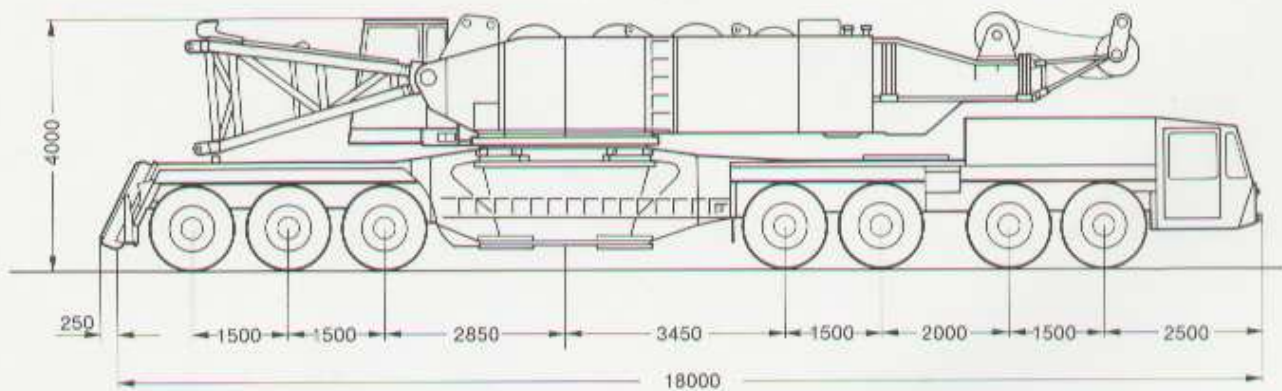

**Bereifung**  
**Tyres**  
**Pneumatici**

14.00 R 25 PR 22

**Fahrleistungen**  
**Carrier performance**  
**Prestazioni del carro**

Fahrtgeschwindigkeit

Travel speeds

Velocità

0-65 km/h

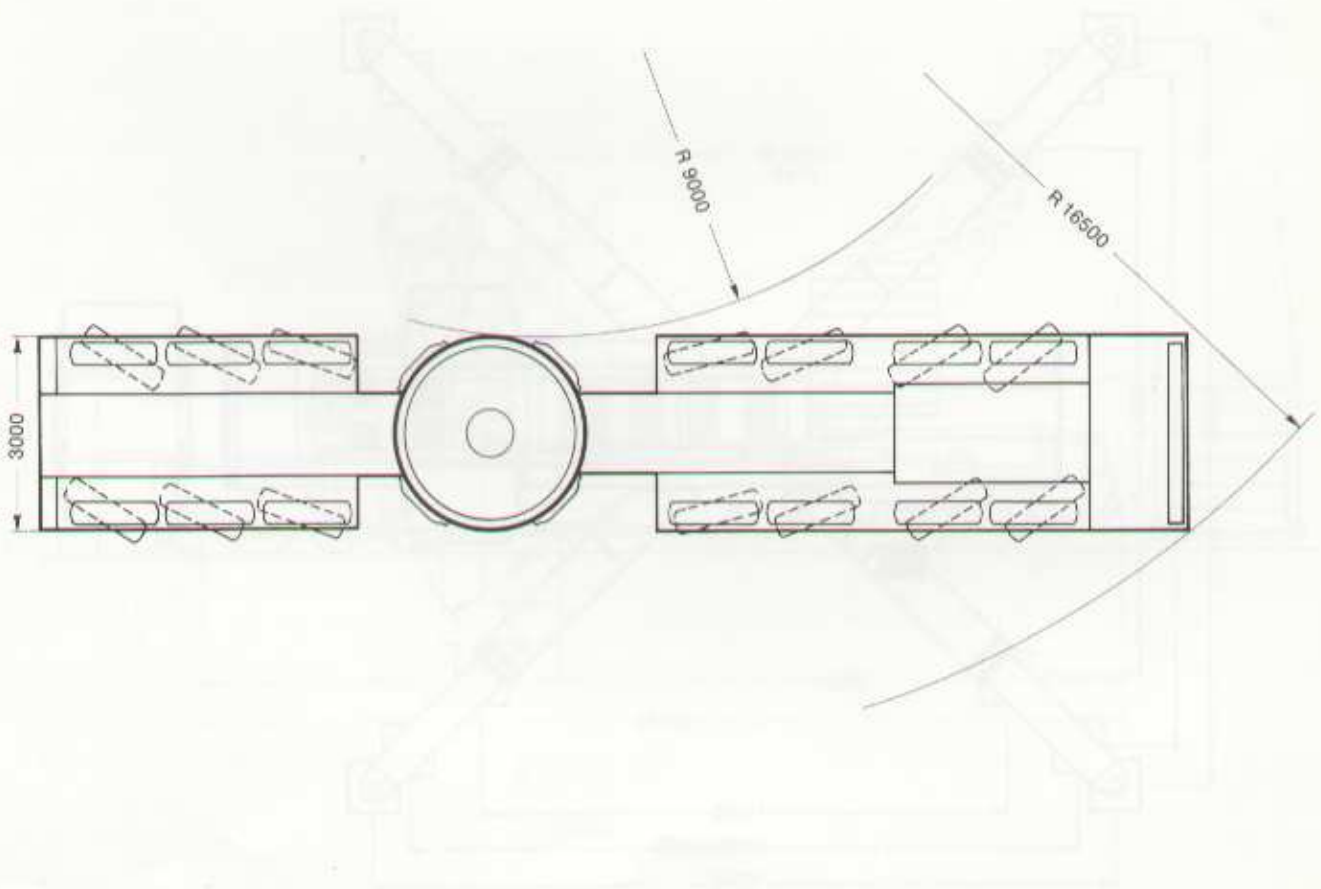

# Technische Daten Specifications Dati tecnici

## Unterflaschen Hook blocks Bozzelli



Tragfähigkeit Capacity Portata	Anzahl der Rollen Number of sheaves Numero di pulegge	Strangzahl Number of lines Numero di taglie	Gewicht Weight Peso	„D“
500 t <sup>1)</sup>	2 x 11	2 x 22	9475 kg	4,60 m
300 t <sup>1)</sup>	2 x 5	2 x 11	8810 kg	4,30 m
250 t	11	22	4620 kg	4,60 m
150 t	5	11	5450 kg	4,30 m
42 t	1	3	2610 kg	2,70 m

<sup>1)</sup> Die Doppelunterflaschen können in Einzelunterflaschen umgebaut werden.  
The double hook blocks may be converted into single hook blocks.  
I bozzelli doppi possono essere trasformati in bozzelli semplici.

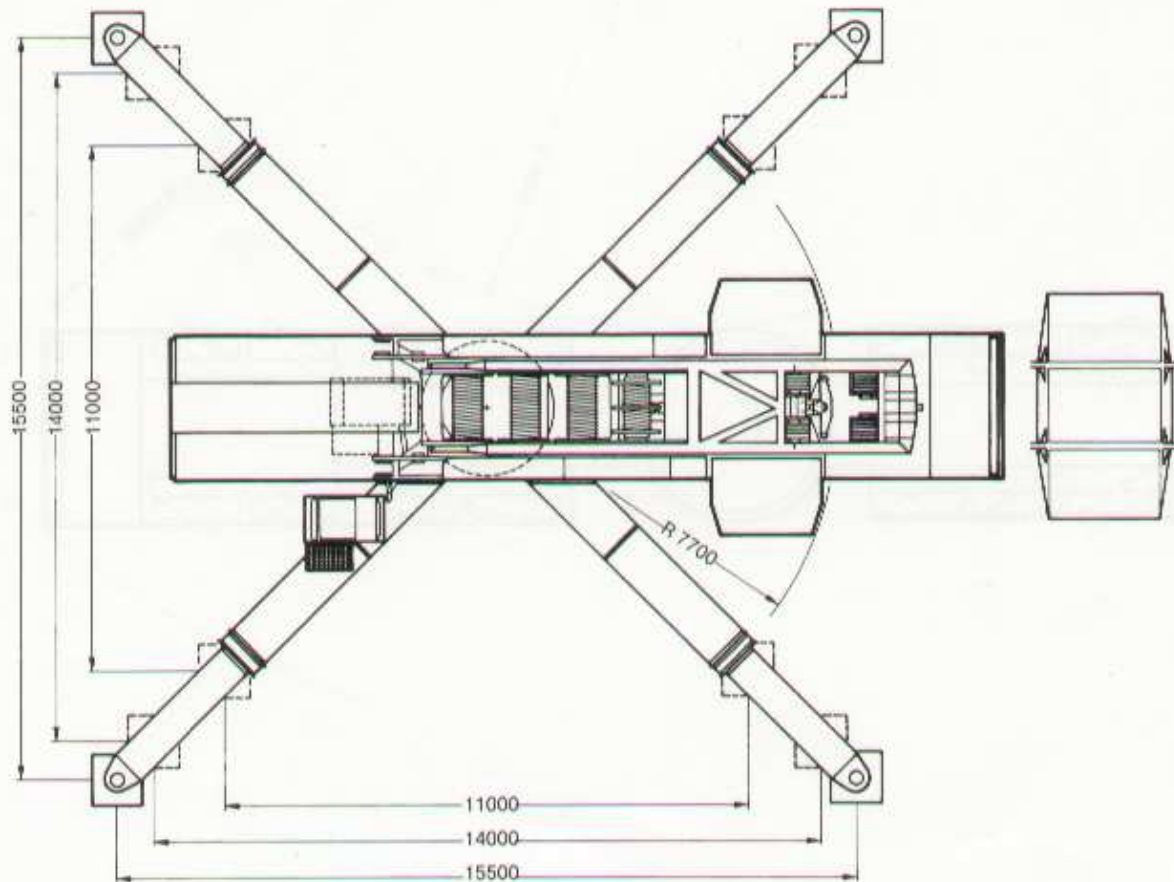

**Arbeitsgeschwindigkeiten (stufenlos regelbar)**  
**Working speeds (infinitely variable)**  
**Velocità di lavoro (a regolazione infinita)**

Antriebe Mechanisms Trazioni	Geschwindigkeiten Speeds Velocità	zulässiger Seilzug je Strang Single line pull Tiro ammissibile su singolo tratto	Länge des Hubseils Length of hoist rope Lunghezza fune
Hubwerk 1 Hoist 1 Argano 1	max. 74 m/min	125 kN	850 m
Hubwerk 2 Hoist 2 Argano 2	max. 74 m/min	125 kN	850 m
Wippwerk Hauptausleger Boom derricking Argano brandeggio posto sul braccio base	max. 41 m/min		870 m
Einziehwerk Boom hoist Argano sollev. braccio base	max. 35 m/min		2 x 225 m
Wippwerk Hilfsausleger Fly jib hoist Argano brandeggio falcone	max. 41 m/min		670 m
Drehwerk (U/min) Slewing (RPM) Motore di rotazione	1		

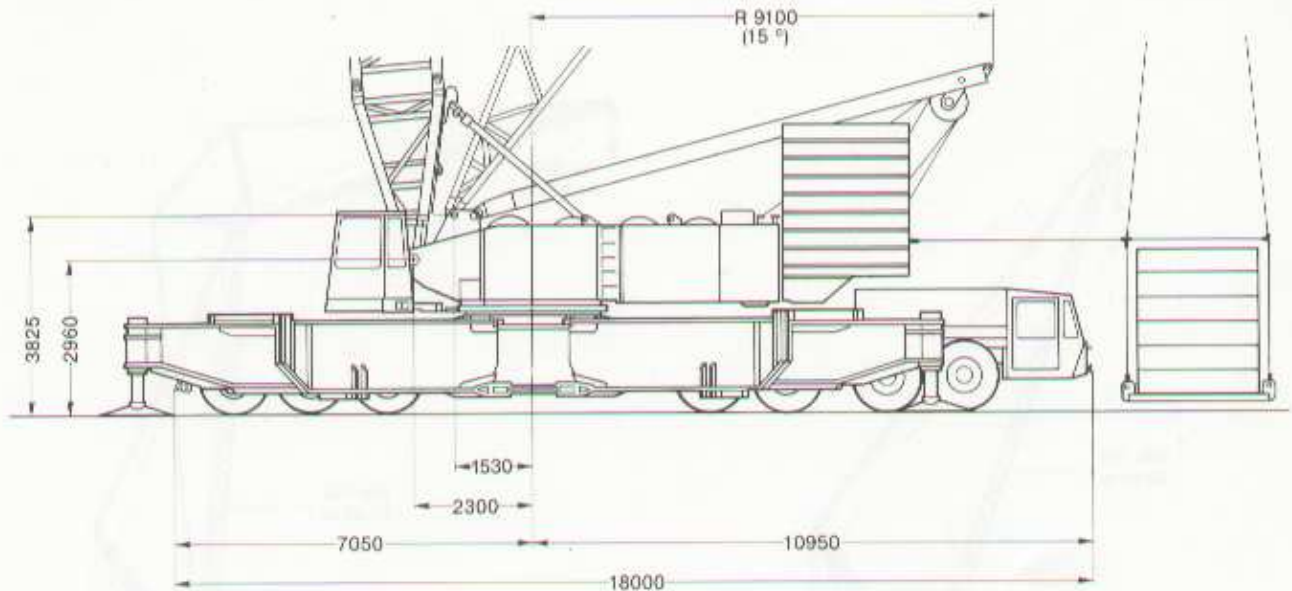

# Ausleger-Kombinationen Boom combinations Combinazioni bracci

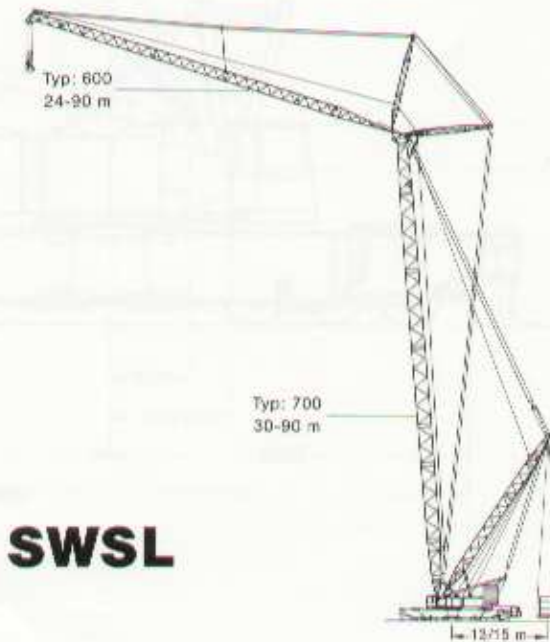
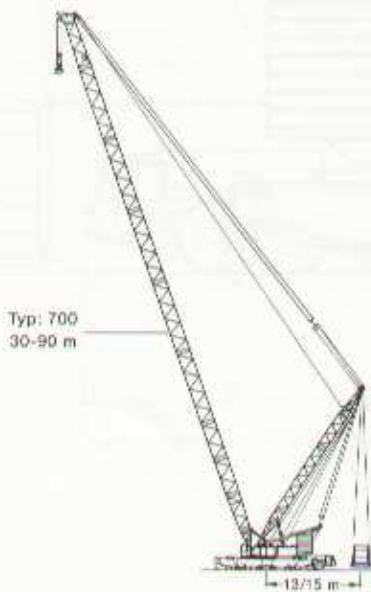
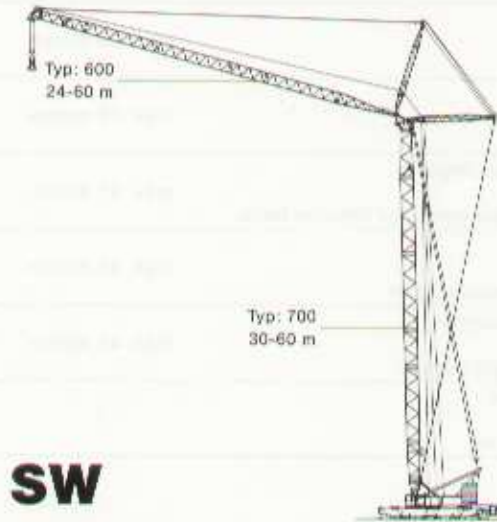
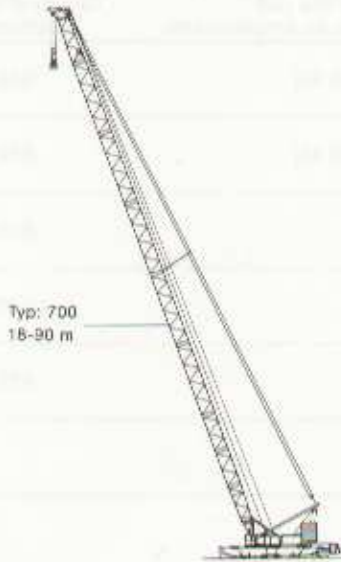

# Anmerkungen über Tragfähigkeiten

## Crane capacity notes

### Condizioni di utilizzazione

Tragfähigkeiten überschreiten nicht 75% der Kipplast.

Tragfähigkeiten 75% entsprechen DIN 15019.2 (Prüflast=1,25 x Hublast + 0,1 x Auslegergewicht, auf die Auslegerspitze reduziert).

Das Gewicht der Unterflaschen sowie die Aufnahmemittel sind Bestandteile der Last und sind von den Tragfähigkeiten abzuziehen.

Kranbetrieb zulässig bis:

Staudruck ..... 60 N/m<sup>2</sup>  
Windgeschwindigkeit ..... 9,8 m/s

Weitere Angaben über Windgeschwindigkeiten in der Bedienungsanleitung des Kranes.

---

Stability ratings do not exceed 75% of tipping load.

75% ratings are in conformity with DIN 15019.2 (test load=1.25 x suspended load + 0.1 x dead weight of boom, reduced to boom point).

Weights of hook blocks and slings are considered part of the load, and are to be deducted from the load ratings.

Crane operation permissible up to a

wind pressure of ..... 60 N/m<sup>2</sup>  
wind speed of ..... 9.8 m/s

Consult operation manual for further details on wind speeds.

---

Le portate non superano il 75% del momento di ribaltamento.

Le portate delle colonne 75% sono conformi alle norme DIN 15019.2 (carico di prova = 1,25 x carico di sollevamento + 0,1 del peso del braccio agente alla punta del braccio stesso).

Il peso del bozzello e delle funi di attracco fanno parte del carico e sono quindi da dedurre dai valori di tabella.

La gru può lavorare sino ad una:

pressione vento di ..... 60 N/m<sup>2</sup>  
velocità vento di ..... 9,8 m/s

Per ulteriori dettagli sulla velocità vento, consultare il manuale di istruzione della gru.

Arbeitsbereiche Hauptausleger  
Working ranges main boom  
Campo di lavoro braccio base

SH

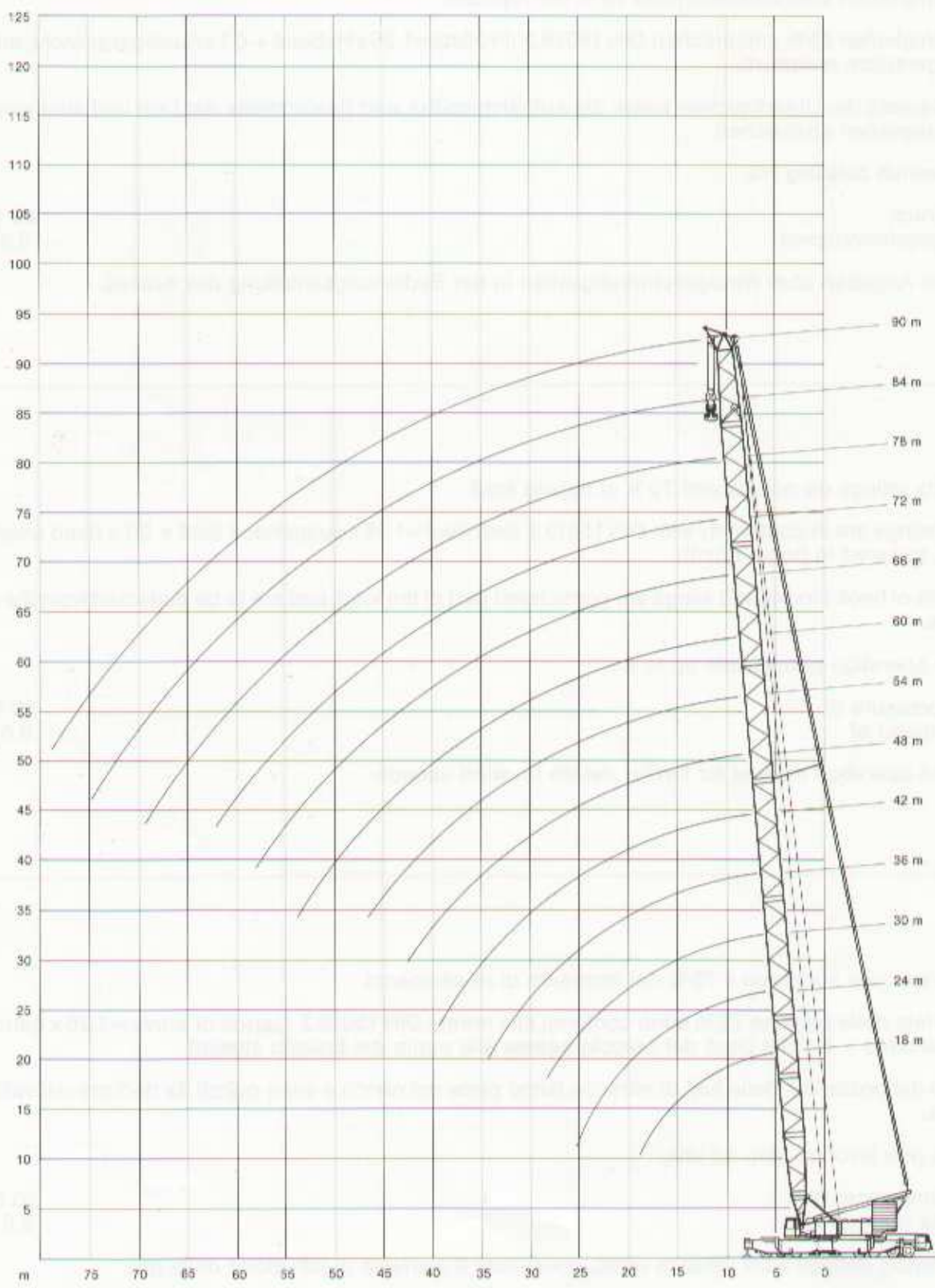



# Tragfähigkeiten Hauptausleger

## Lifting capacities main boom

### Portate braccio base

# SH

 14 x 14 m



149 t

75% 360°

Ausladung	Hauptauslegerlänge · Length of main boom · Lungh. braccio base												
Radius													
Sbraccio	18 m	24 m	30 m	36 m	42 m	48 m	54 m	60 m	66 m	72 m	78 m	84 m	90 m <sup>1)</sup>
m	t	t	t	t	t	t	t	t	t	t	t	t	t
5	500**	-	-	-	-	-	-	-	-	-	-	-	-
6	432*	400*	-	-	-	-	-	-	-	-	-	-	-
7	375*	373*	370*	369*	-	-	-	-	-	-	-	-	-
8	331*	329*	327*	325*	323*	309*	-	-	-	-	-	-	-
9	296*	294*	292*	290*	288*	286*	281*	275*	-	-	-	-	-
10	267*	265*	263*	261*	260*	258*	256*	255*	246*	225*	-	-	-
12	222	220	218	218	215	213*	211*	210*	209*	208*	197*	170*	141*
14	178	185	183	182	180	178*	177*	176*	175*	174*	173*	165*	141*
16	138	157	158	157	155	153	152	151	150*	149*	148*	146*	137*
18	102	129	138	137	135	133	132	131	130*	129*	128*	126*	125*
20	-	108	117	121	120	118	117	115	114	113	112*	111*	110*
22	-	88	99	104	105	105	104	103	102	100	98	97*	96*
24	-	-	85	90	92	92	92	91	90	89	88	85	84
26	-	-	72	79	81	82	82	81	80	78	76	76	74
28	-	-	60	68	71	72	73	72	71	70	68	67	66
30	-	-	-	59	63	64	65	64	63	62	60	60	58
34	-	-	-	43	49	51	52	52	51	50	48	48	47
38	-	-	-	-	36	40	41	42	41	41	39	38	37
42	-	-	-	-	-	30	33	33	33	33	31	31	30
46	-	-	-	-	-	-	25	26	26	26	24	24	23
50	-	-	-	-	-	-	-	20	20	20	19	19	18
54	-	-	-	-	-	-	-	14	15	15	14	14	13
58	-	-	-	-	-	-	-	-	10	11	10	10	9
62	-	-	-	-	-	-	-	-	-	7	8	8	8

 11 x 11 m



131 t

75% 360°

Ausladung	Hauptauslegerlänge · Length of main boom · Lungh. braccio base									
Radius										
Sbraccio	18 m	24 m	30 m	36 m	42 m	48 m	54 m	60 m	66 m	
m	t	t	t	t	t	t	t	t	t	t
5	450*	-	-	-	-	-	-	-	-	-
6	432*	400*	-	-	-	-	-	-	-	-
7	375*	373*	370*	369*	-	-	-	-	-	-
8	331*	329*	327*	325*	323*	309*	-	-	-	-
9	296*	294*	292*	290*	286*	286*	281*	275*	-	-
10	267*	265*	263*	261*	260*	258*	256*	255*	246*	246*
12	222	220	218	218	215	213*	211*	210*	210*	209*
14	176	175	174	173	172	171	171*	170*	170*	169*
16	138	139	139	137	136	135	135	134	134	133*
18	-	115	114	113	112	111	110	109	109	108
20	-	98	97	95	94	93	92	91	91	91
22	-	85	84	82	81	80	79	78	78	77
24	-	-	73	72	71	69	69	67	67	67
26	-	-	65	64	62	61	60	59	59	58
28	-	-	59	57	55	54	53	52	52	51
30	-	-	-	51	50	48	47	46	46	45
34	-	-	-	-	41	39	38	37	37	36
38	-	-	-	-	34	33	32	30	30	29
42	-	-	-	-	-	28	26	25	25	23
46	-	-	-	-	-	-	-	20	20	19
50	-	-	-	-	-	-	-	17	17	15
54	-	-	-	-	-	-	-	14	14	12
56	-	-	-	-	-	-	-	-	-	10

\* Doppelunterflasche erforderlich!

\* Double hook block required!

\* Necessario bozzello doppio!

\*\* mit Schwerlasteinrichtung

\*\* with heavy lift attachment

\*\* Con equipaggiamento heavy lift

<sup>1)</sup> Aufrichten nur bei einer Abstützbasis von 15,5 m

<sup>1)</sup> Erection only with 15.5 m outrigger base

<sup>1)</sup> Sollevabile solo con base d'appoggio 15.5 m.

# Tragfähigkeiten Hauptausleger mit Superlift

## Lifting capacities main boom with Superlift

### Portate braccio base con Superlift

**SSL**
 **15,5 x 15,5 m**  **149 t SL-Radius 15 m** **75% 360°**

Hauptausleger Main Boom Braccio base		Ausladung Radius Sbraccio					Superlift-Gegengewicht · Superlift Counterweight · Contrappeso Superlift				
		0 t	100 t	150 t	200 t	250 t					
m	m	t	t	t	t	t					
<b>54 m</b>	9	330*	-	-	-	-					
	10	310*	-	-	-	-					
	12	239*	330*	-	-	-					
	14	192*	307*	330*	-	-					
	16	160	259*	302*	-	-					
	18	135	223*	265*	297*	-					
	20	117	195*	232*	265*	288*					
	22	102	173*	206*	238*	265*					
	24	90	155	185*	216*	241*					
	28	80	140	168*	195*	220*					
	28	72	127	153	178*	203*					
	30	65	117	140	164	188*					
	34	53	99	120	141	161					
	38	45	86	104	123	141					
	42	38	75	92	108	120					
	46	32	67	82	97	-					
<b>60 m</b>	10	300*	-	-	-	-					
	12	240*	300*	-	-	-					
	14	193*	300*	-	-	-					
	16	159*	260*	300*	-	-					
	18	135	223*	263*	295*	-					
	20	116	195*	232*	263*	-					
	22	101	172*	206*	237*	-					
	24	89	154*	185*	215*	239*					
	26	79	139	167*	195*	219*					
	28	71	127	152	178*	202*					
	30	63	116	140	163*	186*					
	34	52	98	119	140	161*					
	38	43	85	103	122	140					
	42	36	74	91	107	124					
	46	30	66	81	96	108					
	50	26	59	72	86	92					
54	22	53	66	78	-						
<b>66 m</b>	12	240*	-	-	-	-					
	14	192*	260*	-	-	-					
	16	159*	260*	-	-	-					
	18	134*	223*	260*	-	-					
	20	115	194*	232*	260*	-					
	22	100	172*	206*	236*	-					
	24	88	154*	184*	214*	-					
	26	78	138*	166*	194*	-					
	28	69	126	151*	177*	200*					
	30	62	115	139*	163*	186*					
	34	50	97	118	139*	160*					
	38	41	84	102	121	139*					
	42	34	73	90	106	123					
	46	29	64	79	94	109					
	50	24	57	71	85	97					
	54	20	51	64	77	84					
58	17	46	58	70	72						
<b>72 m</b>	12	236*	260*	-	-	-					
	14	192*	260*	-	-	-					
	16	156*	260*	260*	-	-					
	18	133*	223*	260*	-	-					
	20	114	194*	231*	260*	-					
	22	99	171*	205*	235*	-					
	24	87	153*	184*	213*	237*					
	26	77	138*	166*	194*	217*					
	28	68	125*	151*	177*	199*					
	30	61	114	138*	162*	184*					
	34	49	97	117	138*	159*					
	38	40	83	101	120*	138*					
	42	33	72	89	105	122*					
	46	27	64	79	94	109					
	50	23	56	70	84	98					
	54	19	50	63	76	87					
58	15	45	57	69	76						
62	13	41	52	63	66						

\* Doppelunterflasche erforderlich!

\* Double hook block required!

\* Necessario bozzello doppio!

# Tragfähigkeiten Hauptausleger mit Superlift Lifting capacities main boom with Superlift Portate braccio base con Superlift

# SSL

 15,5 x 15,5 m



149 t SL-Radius 15 m

75% 360°

Hauptausleger Main Boom Braccio base	Ausladung Radius Sbraccio	Superlift-Gegengewicht · Superlift Counterweight · Contrappeso Superlift				
m	m	0 t	100 t	150 t	200 t	250 t
78 m	12	212*	-	-	-	-
	14	191*	-	-	-	-
	16	157*	212*	-	-	-
	18	132*	212*	-	-	-
	20	113*	193*	212*	-	-
	22	97	170*	204*	212*	-
	24	85	152*	183*	211*	-
	26	75	137*	165*	193*	-
	28	66	124*	150*	175*	198*
	30	59	113*	137*	161*	183*
	34	47	95	116*	137*	158*
	38	38	81	100	118*	137*
	42	31	71	87	104	120*
	46	25	62	77	92	107*
	50	20	55	68	82	96
54	16	48	61	74	87	
56	13	43	55	67	77	
62	10	39	50	61	68	
66	8	35	45	56	59	
84 m	12	200*	-	-	-	-
	14	192*	-	-	-	-
	16	157*	200*	-	-	-
	18	132*	200*	-	-	-
	20	113*	194*	200*	-	-
	22	97	171*	200*	-	-
	24	85	152*	183*	200*	-
	26	74	137*	165*	191*	-
	28	66	124*	150*	176*	197*
	30	58	113*	137*	161*	182*
	34	47	95	116*	137*	157*
	38	37	81	100	118*	137*
	42	30	70	87	103	120*
	46	24	61	76	91	107*
	50	19	54	68	82	96
54	15	48	61	73	86	
58	12	43	54	66	78	
62	9	38	49	60	69	
66	6	34	45	55	61	
70	4	30	41	50	54	
74	3	27	37	46	47	
90 m	14	175*	-	-	-	-
	16	157*	-	-	-	-
	18	132*	-	-	-	-
	20	112*	175*	-	-	-
	22	97*	171*	-	-	-
	24	84	162*	175*	-	-
	26	74	136*	165*	175*	-
	28	65	123*	149*	174*	-
	30	57	112*	136*	160*	175*
	34	45	94*	115*	136*	156*
	38	36	80	99*	118*	136*
	42	29	69	86	103*	119*
	46	23	60	76	91	106*
	50	18	53	67	81	95*
	54	14	47	60	72	85
58	10	42	53	65	77	
62	8	37	48	59	69	
66	5	32	43	54	62	
70	3	28	39	49	55	
74	1	25	36	45	49	
78	-	22	33	41	43	

- \* Doppelunterflasche erforderlich!
- \* Double hook block required!
- \* Necessario bozzello doppio!

# Tragfähigkeiten Hauptausleger mit Superlift

## Lifting capacities main boom with Superlift

### Portate braccio base con Superlift

**SSL**

**14 x 14 m**  **149 t SL-Radius 13 m** **75% 360°**

Hauptausleger		Superlift-Gegengewicht · Superlift Counterweight · Contrappeso Superlift							
Main Boom	Ausladung	Radius							
Braccio base	Sbraccio	0 t	50 t	100 t	150 t	175 t	200 t	225 t	
m	m	t	t	t	t	t	t	t	
<b>30 m</b>	7	370*	400*	-	-	-	-	-	
	8	322*	400*	-	-	-	-	-	
	9	297*	361*	400*	-	-	-	-	
	10	264*	321*	372*	400*	-	-	-	
	12	215	263*	310*	350*	369*	-	-	
	14	181	221	262*	300*	317*	333*	-	
	16	156	191	226	261*	277*	292*	307*	
	18	136	166	199	230	245	259	272*	
	20	118	149	177	205	219	232	245	
	22	104	134	159	185	197	210	222	
	24	93	122	145	168	179	191	198	
	26	84	110	133	154	164	170	-	
28	76	101	122	142	147	-	-		
<b>36 m</b>	8	321*	400*	-	-	-	-	-	
	9	295*	359*	400*	-	-	-	-	
	10	262*	319*	370*	400*	-	-	-	
	12	214	261*	306*	348*	367*	-	-	
	14	180	220	260	298*	315*	332*	-	
	16	154	189	224	259	276*	290*	305*	
	18	135	166	197	228	243	258	271*	
	20	117	147	175	203	217	231	243	
	22	103	132	158	183	195	208	220	
	24	91	120	143	166	178	189	201	
	26	82	109	131	152	163	173	184	
	28	74	100	120	140	150	160	169	
30	67	91	111	130	139	148	157		
34	57	78	96	113	121	122	-		
<b>42 m</b>	8	320*	400*	-	-	-	-	-	
	9	293*	357*	400*	-	-	-	-	
	10	260*	317*	368*	400*	-	-	-	
	12	212*	259*	306*	346*	365*	-	-	
	14	176	218*	258*	296*	313*	330*	-	
	16	153	187	222*	257*	274*	288*	303*	
	18	133	164	195	226*	241*	256*	269*	
	20	115	146	173	201	215*	229*	241*	
	22	101	131	156	181	193	206*	219*	
	24	90	118	141	164	176	187	199	
	26	80	106	129	150	161	171	182	
	28	72	96	118	138	148	158	168	
30	65	90	109	128	137	146	155		
34	55	77	95	111	119	127	135		
38	46	66	83	98	105	112	119		
<b>48 m</b>	9	291*	355*	376*	-	-	-	-	
	10	259*	316*	366*	378*	-	-	-	
	12	210*	257*	305*	344*	363*	-	-	
	14	176	216*	256*	295*	311*	328*	-	
	16	151	186*	221*	256*	272*	287*	301*	
	18	132	163	193*	224*	240*	254*	267*	
	20	114	144	172	200*	213*	227*	240*	
	22	99	129	154	179*	192*	204*	217*	
	24	88	117	140	163	174	186*	197*	
	26	78	106	127	146	159	170	180*	
	28	70	97	117	136	146	156	166	
	30	63	88	108	126	135	144	154	
34	52	75	93	109	117	125	133		
36	44	65	81	96	103	110	118		
42	38	57	71	85	92	98	105		

- \* Doppelunterflasche erforderlich!
- \* Double hook block required!
- \* Necessario bozzello doppio!

# Tragfähigkeiten Hauptausleger mit Superlift

## Lifting capacities main boom with Superlift

### Portate braccio base con Superlift

**SSL**

**14 x 14 m**  **149 t** **SL-Radius 13 m** **75%** **360°**

Hauptausleger Main Boom Braccio base		Ausladung Radius Sbraccio	Superlift-Gegengewicht · Superlift Counterweight · Contrappeso Superlift						
			0 t	50 t	100 t	150 t	175 t	200 t	225 t
m	m	t	t	t	t	t	t	t	t
54 m	9	290*	330*	-	-	-	-	-	-
	10	257*	315*	330*	-	-	-	-	-
	12	209*	256*	303*	330*	-	-	-	-
	14	175*	215*	255*	294*	310*	327*	-	-
	16	150	185*	220*	255*	271*	285*	300*	-
	18	130	161*	192*	223*	239*	253*	266*	-
	20	113	143	171*	198*	212*	226*	238*	-
	22	99	128	153	178*	191*	203*	216*	-
	24	87	115	138	161*	173*	184*	196*	-
	26	77	105	126	147	158*	168*	179*	-
	28	69	96	116	135	145	155*	165*	-
	30	62	88	106	125	134	143	152	-
	34	51	74	92	108	116	124	132	-
	38	43	64	80	95	102	109	116	-
	42	36	55	70	84	90	97	103	-
	46	31	48	62	75	81	87	93	-
60 m	10	258*	300*	-	-	-	-	-	-
	12	207*	254*	300*	-	-	-	-	-
	14	173*	213*	254*	292*	300*	-	-	-
	16	148*	183*	218*	253*	269*	284*	-	-
	18	129	160*	191*	222*	237*	251*	264*	-
	20	112	141*	169*	197*	211*	224*	237*	-
	22	98	126	151*	176*	189*	202*	214*	-
	24	86	114	137*	160*	171*	183*	194*	-
	26	76	103	124	146*	156*	167*	177*	-
	28	68	94	114	133*	143*	153*	163*	-
	30	61	86	105	123	132*	141*	151*	-
	34	50	73	90	106	114	122	130	-
	38	41	63	78	93	100	107	114	-
	42	34	54	69	82	89	95	102	-
	46	29	46	61	73	79	85	91	-
	50	24	40	54	66	72	77	82	-
54	21	36	49	60	65	70	75	-	
66 m	12	206*	253*	260*	-	-	-	-	-
	14	172*	212*	253*	260*	-	-	-	-
	16	147*	182*	217*	252*	260*	-	-	-
	18	128	159*	190*	221*	236*	250*	260*	-
	20	111	140*	168*	196*	210*	223*	236*	-
	22	97	125	150*	175*	188*	201*	213*	-
	24	85	113	136*	159*	170*	182*	193*	-
	26	75	102	123	145*	155*	166*	176*	-
	28	67	93	113	133*	142*	152*	162*	-
	30	60	86	104	122	131*	140*	150*	-
	34	48	72	89	105	113	121	129	-
	38	40	61	77	92	99	106	113	-
	42	33	52	68	81	87	94	100	-
	46	27	45	59	72	78	84	90	-
	50	23	39	53	65	70	76	81	-
	54	19	34	47	58	64	69	74	-
58	16	29	42	53	58	63	68	-	
72 m	12	205*	236*	-	-	-	-	-	-
	14	171*	211*	236*	-	-	-	-	-
	16	146*	181*	216*	236*	-	-	-	-
	18	127*	158*	189*	219*	235*	-	-	-
	20	111	139*	167*	195*	208*	222*	234*	-
	22	96	124*	149*	174*	187*	199*	212*	-
	24	84	112	135*	156*	169*	181*	192*	-
	26	74	91	122*	143*	154*	165*	175*	-
	28	66	82	112	131*	141*	151*	161*	-
	30	59	74	103	121*	130*	139*	148*	-
	34	47	71	88	104	112	120*	128*	-
	38	38	60	76	91	98	105	112	-
	42	31	51	67	80	86	93	99	-
	46	26	43	58	71	77	83	89	-
	50	21	37	52	64	69	74	80	-
	54	17	32	46	57	62	67	72	-
58	14	28	41	51	57	61	66	-	
62	11	24	37	47	52	56	61	-	

\* Doppelunterflasche erforderlich!  
 \* Double hook block required!  
 \* Necessario bozzello doppio!

# Tragfähigkeiten Hauptausleger mit Superlift

## Lifting capacities main boom with Superlift

### Portate braccio base con Superlift

**SSL**

 **14 x 14 m**  **149 t SL-Radius 13 m** **75% 360°**

Hauptausleger Main Boom Braccio base		Ausladung Radius Sbraccio	Superlift-Gegengewicht · Superlift Counterweight · Contrappeso Superlift						
m		m	0 t	50 t	100 t	150 t	175 t	200 t	225 t
			t	t	t	t	t	t	t
<b>78 m</b>	12		200*	-	-	-	-	-	-
	14		170*	200*	-	-	-	-	-
	16		145*	180*	200*	-	-	-	-
	18		126*	156*	187*	200*	-	-	-
	20		109	138*	166*	193*	200*	-	-
	22		94	123*	148*	173*	186*	198*	200*
	24		82	110*	133*	156*	168*	179*	191*
	26		72	100	121*	142*	153*	164*	174*
	28		64	91	111*	130*	140*	150*	160*
	30		56	83	102	120*	129*	138*	147*
	34		45	69	87	103	111*	119*	127*
	36		36	58	75	89	97	104	111*
	42		29	49	65	79	85	92	98
	46		23	41	57	70	76	82	88
50		19	35	50	62	66	73	79	
54		15	30	44	55	61	66	71	
58		12	25	39	50	55	60	65	
62		9	22	34	45	50	54	59	
66		6	18	30	41	45	50	54	
70		-	16	27	37	41	45	50	
<b>84 m</b>	14		168*	160*	-	-	-	-	-
	16		143*	176*	180*	-	-	-	-
	18		124*	155*	180*	-	-	-	-
	20		109*	138*	164*	180*	-	-	-
	22		94	121*	147*	172*	178*	-	-
	24		82	109*	132*	155*	166*	176*	-
	26		72	98*	120*	141*	151*	162*	173*
	28		63	89	109*	129*	139*	148*	158*
	30		56	82	100*	118*	127*	137*	146*
	34		44	69	85	101*	109*	117*	125*
	36		36	57	73	88	95*	102*	109*
	42		28	48	64	77	84	90	97*
	46		23	40	56	68	74	80	86
	50		18	34	49	61	66	72	77
54		14	29	44	55	60	65	70	
58		11	24	38	49	54	59	63	
62		8	21	34	44	49	53	58	
66		5	17	29	40	44	49	53	
70		-	15	26	36	40	45	49	
74		-	12	23	33	37	41	45	
<b>90 m</b>	14		155*	-	-	-	-	-	-
	16		142*	155*	-	-	-	-	-
	18		123*	154*	155*	-	-	-	-
	20		108*	135*	154*	-	-	-	-
	22		93*	120*	146*	153*	-	-	-
	24		81	108*	131*	152*	-	-	-
	26		71	97*	119*	140*	150*	151*	-
	28		62	88*	108*	128*	138*	147*	148*
	30		55	81	99*	117*	127*	136*	144*
	34		43	68	84*	100*	106*	116*	124*
	38		34	58	72	87*	94*	101*	108*
	42		27	47	63	76	83*	89*	96*
	46		21	39	55	67	73	79	85*
	50		17	33	48	60	65	71	76
54		13	28	42	54	59	64	69	
58		9	23	37	48	53	57	62	
62		6	19	32	43	48	52	57	
66		-	16	28	39	43	48	52	
70		-	13	24	35	39	43	47	
74		-	11	21	32	36	40	44	
78		-	8	18	29	32	36	40	

\* Doppelunterflasche erforderlich!

\* Double hook block required!

\* Necessario bozzello doppio!

# Tragfähigkeiten Hauptausleger mit Superlift Lifting capacities main boom with Superlift Portate braccio base con Superlift

**SSL**
 **11 x 11 m**  **131 t SL-Radius 13 m** **75% 360°**

Hauptausleger Main Boom Braccio base		Ausladung Radius Sbraccio	Superlift-Gegengewicht · Superlift Counterweight · Contrappeso Superlift						
			0 t	50 t	100 t	150 t	175 t	200 t	225 t
m	m	t	t	t	t	t	t	t	t
<b>30 m</b>	7	370*	400*	-	-	-	-	-	-
	8	322*	400*	-	-	-	-	-	-
	9	297*	361*	400*	-	-	-	-	-
	10	264*	321*	372*	400*	-	-	-	-
	12	215	263*	310*	350*	363*	-	-	-
	14	181	221	262*	300*	317*	332*	-	-
	16	149	191	226	261*	277*	292*	307*	-
	18	124	166	199	230	245	259	272*	-
	20	105	149	177	205	219	232	245	-
	22	91	132	159	185	197	210	222	-
	24	80	116	145	168	179	191	196	-
	26	70	103	133	154	164	170	-	-
	26	63	93	122	142	147	-	-	-
	<b>36 m</b>	8	321*	400*	-	-	-	-	-
9		295*	359*	400*	-	-	-	-	-
10		262*	319*	370*	400*	-	-	-	-
12		214	261*	306*	348*	361*	-	-	-
14		180	220	260	298*	315*	330*	-	-
16		148	189	224	259	276*	290*	305*	-
18		122	166	197	228	243	256	271*	-
20		103	147	175	203	217	231	243	-
22		89	130	158	183	195	208	220	-
24		78	115	143	166	178	189	201	-
26		69	102	131	152	163	173	184	-
28		62	92	120	140	150	160	169	-
30		56	83	111	130	139	148	157	-
34		46	70	94	113	121	122	-	-
<b>42 m</b>	8	320*	399*	-	-	-	-	-	-
	9	293*	357*	398*	-	-	-	-	-
	10	260*	317*	368*	396*	-	-	-	-
	12	212*	259*	306*	346*	359*	-	-	-
	14	178	218*	258*	296*	313*	328*	-	-
	16	147	187	222*	257*	274*	288*	303*	-
	18	121	164	195	226*	241*	256*	269*	-
	20	102	146	173	201	215*	229*	241*	-
	22	88	129	156	181	193	206*	219*	-
	24	77	113	141	164	176	187	199	-
	26	68	100	129	150	161	171	182	-
	28	60	90	118	138	148	158	168	-
	30	54	82	109	128	137	146	155	-
	34	45	69	92	111	119	127	135	-
38	38	59	79	98	105	112	119	-	
<b>48 m</b>	9	291*	355*	378*	-	-	-	-	-
	10	259*	316*	366*	-	-	-	-	-
	12	210*	257*	305*	344*	357*	-	-	-
	14	176	216*	256*	295*	311*	327*	-	-
	16	145	186*	221*	256*	272*	287*	301*	-
	18	120	163	193*	224*	240*	254*	267*	-
	20	101	144	172	200*	213*	227*	240*	-
	22	87	128	154	179*	192*	204*	217*	-
	24	75	112	140	163	174	186*	197*	-
	26	66	99	127	148	159	170	180*	-
	28	59	89	117	136	146	156	166	-
	30	53	80	108	126	136	144	154	-
	34	43	67	91	109	117	125	133	-
	38	36	57	78	96	103	110	118	-
42	31	49	68	85	92	98	105	-	

\* Doppelunterflasche erforderlich!

\* Double hook block required!

\* Necessario bozzello doppio!

# Tragfähigkeiten Hauptausleger mit Superlift

## Lifting capacities main boom with Superlift

### Portate braccio base con Superlift

**SSL**
**11 x 11 m**  **131 t SL-Radius 13 m** **75% 360°**

Hauptausleger Main Boom Braccio base		Superlift-Gegengewicht · Superlift Counterweight · Contrappeso Superlift						
Ausladung Radius Sbraccio		0 t	50 t	100 t	150 t	175 t	200 t	225 t
m	m	t	t	t	t	t	t	t
54 m	9	290*	330*	-	-	-	-	-
	10	257*	315*	330*	-	-	-	-
	12	209*	256*	303*	330*	-	-	-
	14	175*	215*	255*	294*	310*	325*	-
	16	146	185*	220*	255*	271*	285*	300*
	18	119	161*	192*	223*	235*	253*	266*
	20	100	143	171*	198*	212*	226*	238*
	22	86	127	153	178*	191*	203*	216*
	24	75	111	138	161*	173*	184*	196*
	26	66	99	126	147	158*	168*	179*
	28	58	88	116	135	145	155*	165*
	30	52	80	106	125	134	143	152
	34	42	66	90	108	116	124	132
	38	35	56	77	95	102	109	116
42	30	48	67	84	90	97	103	
46	25	42	59	75	81	87	93	
60 m	10	256*	300*	-	-	-	-	-
	12	207*	254*	300*	-	-	-	-
	14	173*	213*	254*	292*	300*	-	-
	16	145*	183*	218*	253*	269*	284*	-
	18	118	160*	191*	222*	237*	251*	264*
	20	99	141*	169*	197*	211*	224*	237*
	22	85	126	151*	176*	189*	202*	214*
	24	74	110	137*	160*	171*	183*	194*
	26	65	97	124	146*	156*	167*	177*
	28	57	87	114	133*	143*	153*	163*
	30	51	78	105	123	132*	141*	151*
	34	41	65	88	106	114	122	130
	38	34	55	75	93	100	107	114
	42	28	47	65	82	89	95	102
46	23	40	57	73	79	85	91	
50	19	35	50	66	72	77	82	
54	16	31	45	59	65	70	75	
66 m	12	206*	253*	260*	-	-	-	-
	14	172*	212*	253*	260*	-	-	-
	16	144*	182*	217*	252*	260*	-	-
	18	118	159*	190*	221*	236*	250*	260*
	20	99	140*	168*	196*	210*	223*	236*
	22	84	125	150*	175*	188*	201*	213*
	24	73	109	136*	159*	170*	182*	193*
	26	64	97	123	145*	155*	166*	176*
	28	56	86	113	133*	142*	152*	162*
	30	50	77	104	122	131*	140*	150*
	34	40	64	87	105	113	121	129
	38	33	54	74	92	99	106	113
	42	27	46	64	81	87	94	100
	46	22	39	56	72	78	84	90
50	18	34	49	64	70	76	81	
54	15	30	44	58	64	69	74	
58	12	26	39	52	58	63	68	
72 m	12	205*	236*	-	-	-	-	-
	14	171*	211*	236*	-	-	-	-
	16	143*	181*	216*	236*	-	-	-
	18	117	158*	189*	219*	325*	-	-
	20	98	139*	167*	195*	208*	222*	234*
	22	83	124*	149*	174*	187*	199*	212*
	24	72	108	135*	158*	169*	181*	192*
	26	63	91	122*	143*	154*	165*	175*
	28	55	85	112	131*	141*	151*	161*
	30	49	77	103	121*	130*	139*	148*
	34	39	63	86	104	112	120*	126*
	38	32	52	73	91	98	105	112
	42	25	44	63	80	86	93	99
	46	21	38	55	71	77	83	89
50	17	33	46	63	69	74	80	
54	13	28	42	56	62	67	72	
58	11	24	38	51	57	61	66	
62	8	21	34	46	52	56	61	

\* Doppelunterflasche erforderlich!

\* Double hook block required!

\* Necessario bozzello doppio!



# Tragfähigkeiten Hauptausleger mit Superlift Lifting capacities main boom with Superlift Portate braccio base con Superlift

**SSL**

**11 x 11 m**  **131 t SL-Radius 13 m** **75% 360°**

Hauptausleger Main Boom Braccio base	Ausladung Radius Sbraccio	Superlift-Gegengewicht · Superlift Counterweight · Contrappeso Superlift						
m	m	0 t	50 t	100 t	150 t	175 t	200 t	225 t
	12	200*	-	-	-	-	-	-
	14	170*	200*	-	-	-	-	-
	16	143*	180*	200*	-	-	-	-
	18	116*	156*	187*	200*	-	-	-
	20	97	138*	166*	193*	200*	-	-
	22	82	123*	148*	173*	186*	196*	200*
	24	71	107	133*	158*	168*	179*	191*
	26	62	95	121*	142*	153*	164*	174*
	28	54	84	111*	130*	140*	150*	160*
	30	48	76	102	120*	129*	138*	147*
<b>78 m</b>	34	38	62	85	103	111*	119*	127*
	38	30	51	72	89	97	104	111*
	42	24	43	62	79	85	92	98
	46	19	37	53	70	76	82	88
	50	15	31	47	62	68	73	79
	54	12	27	41	55	61	66	71
	58	9	23	36	49	55	60	65
	62	7	19	32	44	50	54	59
	66	-	17	28	40	45	50	54
	70	-	13	24	35	40	44	49
	14	168*	180*	-	-	-	-	-
	16	142*	178*	180*	-	-	-	-
	18	115*	155*	180*	-	-	-	-
	20	96*	136*	164*	180*	-	-	-
	22	81	121*	147*	172*	178*	-	-
	24	70	106*	132*	155*	166*	176*	-
	26	61	94	120*	141*	151*	162*	173*
	28	53	83	109*	129*	139*	148*	158*
	30	47	74	100*	118*	127*	137*	146*
<b>84 m</b>	34	37	61	84	101*	109*	117*	125*
	38	29	50	71	88	95*	102*	109*
	42	23	42	61	77	84	90	97*
	46	18	35	52	68	74	80	86
	50	14	30	46	61	66	72	77
	54	10	25	40	54	60	65	70
	58	8	21	35	48	54	59	63
	62	5	18	31	43	49	53	58
	66	-	15	27	39	44	49	53
	70	-	13	24	35	40	45	49
	74	-	11	21	32	37	41	45
	14	155*	-	-	-	-	-	-
	16	141*	155*	-	-	-	-	-
	18	115*	154*	155*	-	-	-	-
	20	95*	135*	154*	-	-	-	-
	22	81	120*	146*	153*	-	-	-
	24	69	106*	131*	152*	-	-	-
	26	60	93*	119*	140*	150*	151*	-
	28	52	82	108*	128*	138*	147*	148*
	30	46	74	99*	117*	127*	136*	144*
	34	36	60	83	100*	108*	116*	124*
<b>90 m</b>	38	28	49	70	87*	94*	101*	108*
	42	22	41	60	76	83*	89*	96*
	46	17	34	51	67	73	79	85*
	50	12	29	45	60	65	71	76
	54	9	24	39	53	59	64	69
	58	6	20	34	47	53	57	62
	62	-	17	29	42	48	52	57
	66	-	14	26	37	43	48	52
	70	-	11	22	33	39	43	47
	74	-	9	20	30	35	40	44
	78	-	7	17	27	32	36	40

\* Doppelunterflasche erforderlich!

\* Double hook block required!

\* Necessario bozzello doppio!

Arbeitsbereiche Hauptausleger mit Superlift  
Working ranges main boom with Superlift  
Campo di lavoro braccio base con Superlift

SSL

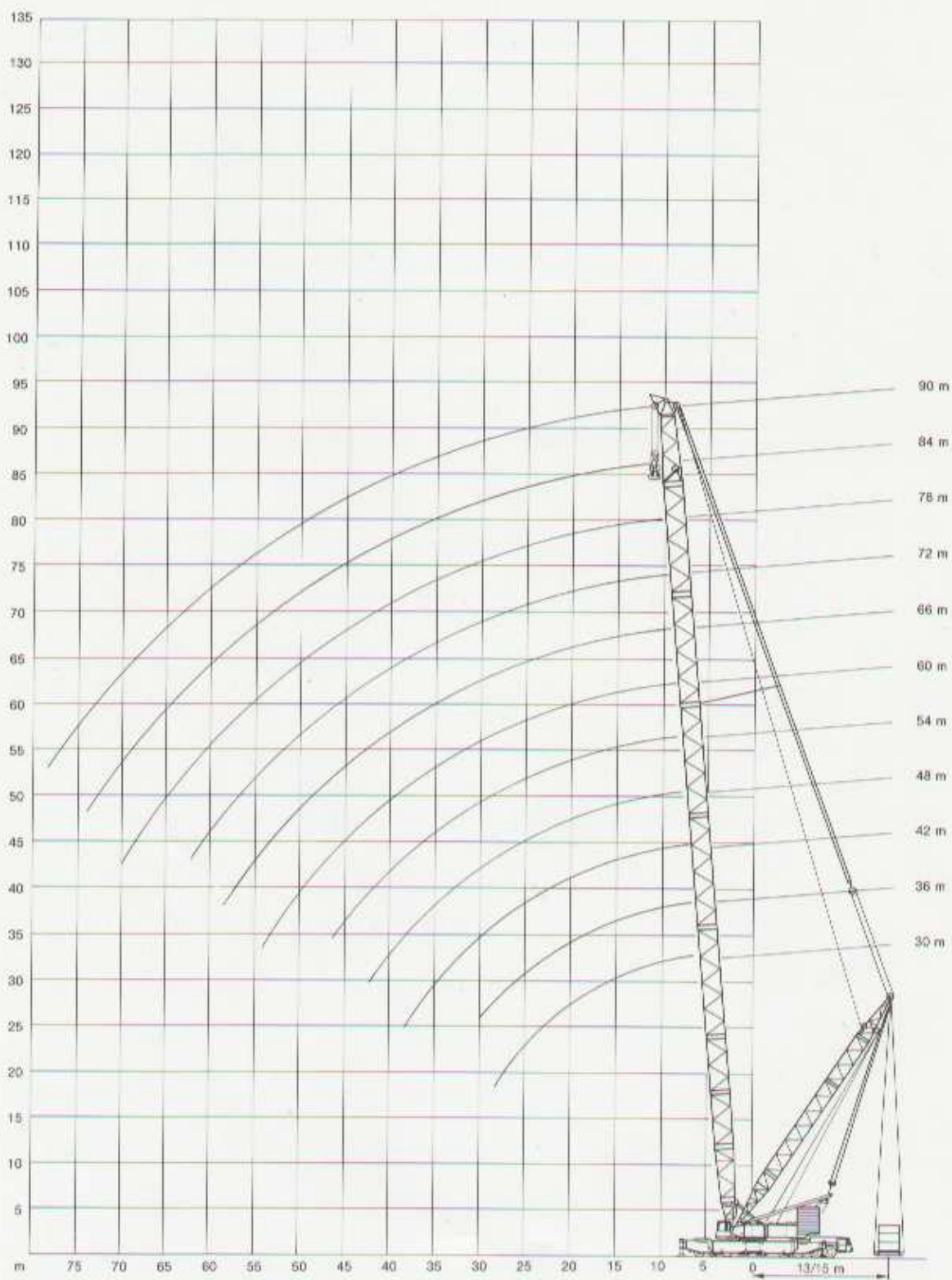

Arbeitsbereiche wippbarer Hilfsausleger  
 Working ranges luffing fly jib  
 Campo di lavoro falcone a volata variabile

SW

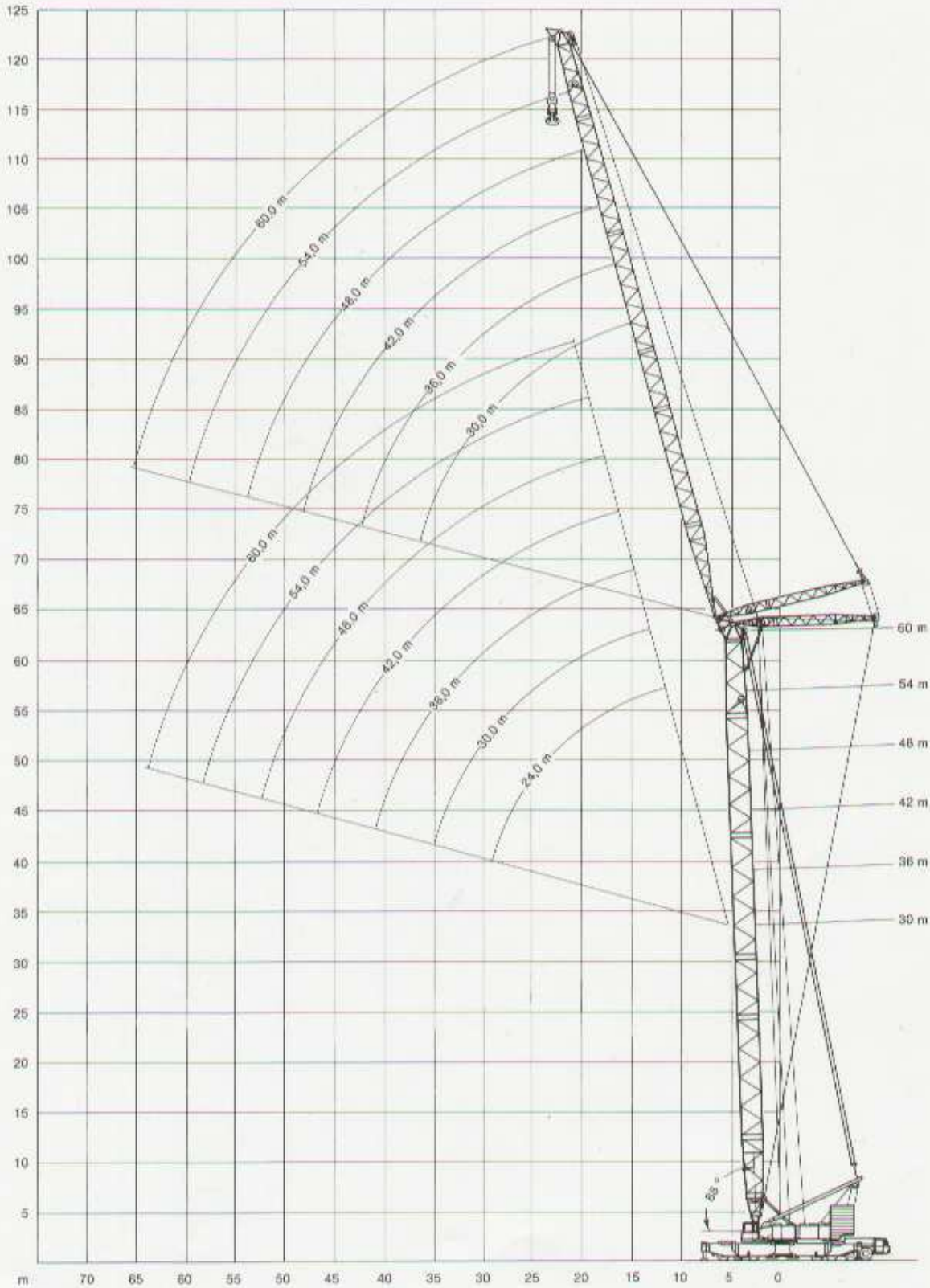

# Tragfähigkeiten wippbarer Hilfsausleger

## Lifting capacities luffing fly jib

### Portate falcone a volata variabile

**SW**
 **14 x 14 m**

**149 t**
**75% 360°**

Hauptausleger		Hilfsausleger · Fly Jib · Falcone							
Main Boom	Ausladung	Radius							
Braccio base	Sbraccio	24 m	30 m	36 m	42 m	48 m	54 m	60 m	
m	m	t	t	t	t	t	t	t	
<b>30 m</b>	14	163*	-	-	-	-	-	-	
	16	141*	139*	-	-	-	-	-	
	18	124	121	119	117	-	-	-	
	20	108	108	106	103	94	-	-	
	22	93	95	95	93	91	75	-	
	24	81	83	85	84	82	75	63	
	26	72	73	75	75	75	74	63	
	28	65	65	67	67	69	67	63	
	30	-	58	60	60	62	61	61	
	34	-	-	50	49	51	50	50	
	38	-	-	42	42	43	42	42	
	42	-	-	-	36	36	36	36	
	46	-	-	-	-	32	31	31	
	50	-	-	-	-	28	26	26	
54	-	-	-	-	-	23	23		
58	-	-	-	-	-	-	20		
62	-	-	-	-	-	-	17		
<b>36 m</b>	14	161*	-	-	-	-	-	-	
	16	139*	136*	-	-	-	-	-	
	18	122	119*	117	-	-	-	-	
	20	108	107	104	102	67	-	-	
	22	94	95	94	91	67	70	-	
	24	82	84	84	83	81	70	60	
	26	73	74	76	76	74	70	60	
	28	65	66	68	68	67	66	60	
	30	-	60	61	61	63	61	59	
	34	-	-	50	50	51	51	51	
	38	-	-	43	42	43	42	43	
	42	-	-	-	36	37	36	36	
	46	-	-	-	-	32	31	31	
	50	-	-	-	-	28	27	27	
54	-	-	-	-	-	23	23		
58	-	-	-	-	-	-	20		
62	-	-	-	-	-	-	18		
<b>42 m</b>	14	158*	-	-	-	-	-	-	
	16	136*	134*	-	-	-	-	-	
	18	120*	117	115*	-	-	-	-	
	20	106	105	102	100	-	-	-	
	22	96	94	92	90	81	65	-	
	24	84	85	84	81	79	65	58	
	26	74	76	76	74	72	65	58	
	28	66	67	69	69	67	65	58	
	30	-	60	62	61	61	59	58	
	34	-	50	51	50	52	51	50	
	38	-	-	43	42	43	43	43	
	42	-	-	-	36	37	36	36	
	46	-	-	-	-	32	31	31	
	50	-	-	-	-	28	27	27	
54	-	-	-	-	-	23	23		
58	-	-	-	-	-	-	20		
62	-	-	-	-	-	-	18		
<b>48 m</b>	14	152*	-	-	-	-	-	-	
	16	134*	133*	-	-	-	-	-	
	18	118*	115*	113*	-	-	-	-	
	20	105	103*	100*	96*	-	-	-	
	22	95	92	90	88*	76*	-	-	
	24	85	84	82	79	76*	62	54	
	26	75	76	74	73	71*	62	54	
	28	67	68	69	67	65	62	54	
	30	-	61	62	61	60	59	54	
	34	-	50	51	51	51	51	49	
	38	-	-	43	42	44	43	42	
	42	-	-	-	36	37	36	37	
	46	-	-	-	-	32	31	31	
	50	-	-	-	-	28	24	27	
54	-	-	-	-	-	23	23		
58	-	-	-	-	-	-	21		
62	-	-	-	-	-	-	18		

\* Doppelunterflasche erforderlich!

\* Double hook block required!

\* Necessario bozzello doppio!

# Tragfähigkeiten wippbarer Hilfsausleger

## Lifting capacities luffing fly jib

### Portate falcone a volata variabile

**SW**

 **14 x 14 m**  **149 t**

**75% 360°**

Hauptausleger	Ausladung	Hilfsausleger · Fly Jib · Falcone							
Main Boom	Radius	24 m	30 m	36 m	42 m	48 m	54 m	60 m	
Braccio base	Sbraccio	t	t	t	t	t	t	t	
m	m								
<b>54 m</b>	16	131*	118*	-	-	-	-	-	
	18	115*	113*	106*	-	-	-	-	
	20	103	100*	95*	88*	-	-	-	
	22	93	90	85*	86*	72	-	-	
	24	84	82	80	78	72	60	-	
	26	76	75	73	71	69	60	50	
	28	67	68	67	65	64	60	50	
	30	-	61	62	61	59	57	50	
	34	-	50	52	51	51	49	48	
	38	-	-	43	43	44	43	42	
	42	-	-	-	36	37	36	37	
	46	-	-	-	31	32	31	32	
	50	-	-	-	-	28	27	27	
	54	-	-	-	-	-	23	24	
58	-	-	-	-	-	-	21		
62	-	-	-	-	-	-	18		
<b>60 m</b>	18	-	112*	105*	-	-	-	-	
	20	-	99*	97*	85*	-	-	-	
	22	-	89*	87*	85*	70	-	-	
	24	-	81	79	77*	70	58	-	
	26	-	74	72	70	68	58	48	
	28	-	68	66	64	63	58	48	
	30	-	62	61	60	58	56	48	
	34	-	51	52	51	50	48	47	
	38	-	-	43	43	43	42	41	
	42	-	-	-	36	37	36	36	
	46	-	-	-	31	32	31	31	
	50	-	-	-	-	28	27	27	
	54	-	-	-	-	-	23	24	
	58	-	-	-	-	-	-	21	
62	-	-	-	-	-	-	18		

\* Doppelunterflasche erforderlich!

\* Double hook block required!



\* Necessario bozello doppio!

# Tragfähigkeiten wippbarer Hilfsausleger

## Lifting capacities luffing fly jib

### Portate falcone a volata variabile

**SW**

 **11 x 11 m**  **131 t**

**75% 360°**

Hauptausleger		Hilfsausleger · Fly Jib · Falcone						
Main Boom	Ausladung	Radius						
Braccio base	Sbraccio	24 m	30 m	36 m	42 m <sup>1)</sup>	48 m	54 m	60 m
m	m	t	t	t	t	t	t	t
<b>30 m</b>	14	163*	-	-	-	-	-	-
	16	141*	139*	-	-	-	-	-
	18	122	121	119	117	-	-	-
	20	104	104	103	102	94	-	-
	22	91	90	89	88	88	76	-
	24	80	79	79	78	78	73	63
	26	71	70	70	69	69	68	63
	28	64	63	63	62	62	61	61
	30	-	58	57	56	56	55	55
	34	-	-	48	47	47	46	46
	38	-	-	41	40	40	39	39
	42	-	-	-	34	34	34	33
	46	-	-	-	-	30	29	29
	50	-	-	-	-	26	26	25
54	-	-	-	-	-	23	22	
58	-	-	-	-	-	-	19	
62	-	-	-	-	-	-	17	
<b>36 m</b>	14	161*	-	-	-	-	-	-
	16	139*	136*	-	-	-	-	-
	18	122	119*	117	-	-	-	-
	20	104	103	103	102	87	-	-
	22	90	89	89	88	87	70	-
	24	80	79	78	77	77	70	60
	26	71	70	70	69	69	68	60
	28	64	63	62	62	62	61	60
	30	-	57	57	56	56	55	55
	34	-	-	47	46	46	46	45
	38	-	-	40	39	39	39	38
	42	-	-	-	34	34	33	33
	46	-	-	-	-	29	29	28
	50	-	-	-	-	26	25	25
54	-	-	-	-	-	22	22	
58	-	-	-	-	-	-	19	
62	-	-	-	-	-	-	17	
<b>42 m</b>	14	158*	-	-	-	-	-	-
	16	136*	134*	-	-	-	-	-
	18	129*	117	115*	-	-	-	-
	20	103	103	102	100*	-	-	-
	22	90	89	88	88	81	65	-
	24	79	78	78	77	77	65	58
	26	70	70	69	68	68	65	58
	28	63	63	62	61	61	61	58
	30	-	57	56	55	55	55	54
	34	-	48	47	46	46	46	45
	38	-	-	40	39	39	38	38
	42	-	-	-	34	34	33	33
	46	-	-	-	-	29	29	28
	50	-	-	-	-	26	25	25
54	-	-	-	-	-	22	22	
58	-	-	-	-	-	-	19	
62	-	-	-	-	-	-	17	

\* Doppelunterflasche erforderlich!

\* Double hook block required!

\* Necessario bozzello doppio!

Arbeitsbereiche wippbarer Hilfsausleger mit Superlift  
 Working ranges luffing fly jib with Superlift  
 Campo di lavoro falcone a volata variabile con Superlift

**SWSL**

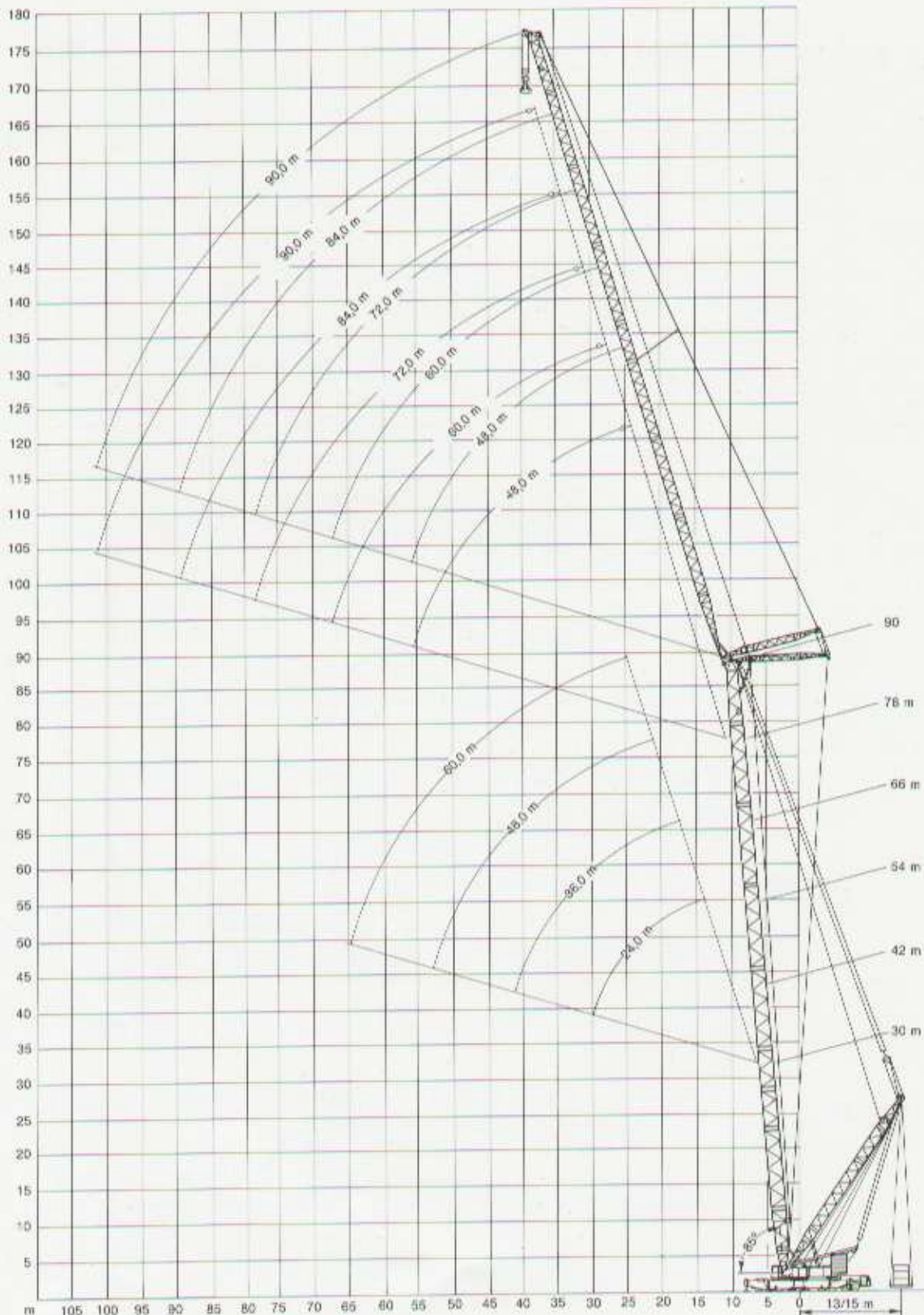

Tragfähigkeiten wippbarer Hilfsausleger mit Superlift  
 Lifting capacities luffing fly jib with Superlift  
 Portate falcone a voltata variabile con Superlift

**SWSL**

 **14 x 14 m**  **149 t SL-Radius 13 m** **75% 360°**

		Superlift-Gegengewicht · Superlift Counterweight · Contrappeso Superlift				
Hauptausleger Main Boom Braccio base	Hilfsausleger Fly Jib Falcone	Ausladung Radius Sbraccio	0 t	50 t	100 t	150 t
m	m	t	t	t	t	t
30 m	24 m	16	153*	163*	-	-
		18	134*	163*	-	-
		20	120	147*	153*	-
		22	108	133*	146*	-
		24	98	121	138*	-
		26	90	111	131*	-
	36 m	26	83	102	122	-
		20	118	133*	-	-
		22	106	131*	133*	-
		24	96	119*	126*	-
		26	88	109	120*	-
		28	81	100	114	-
42 m	48 m	30	74	93	109	-
		34	63	81	97	-
		38	54	71	85	-
		24	94	101	-	-
		26	86	101	-	-
		28	79	99	101	-
	60 m	30	73	91	101	-
		34	62	79	95	-
		38	52	69	84	-
		42	45	62	75	-
		46	40	56	66	-
		50	35	50	55	-
48 m	24 m	28	72	-	-	-
		30	69	72	-	-
		34	59	72	-	-
		38	51	66	72	-
		42	44	60	66	-
		46	38	54	62	-
	36 m	50	34	48	56	-
		54	30	44	51	-
		58	27	40	44	-
		62	24	37	38	-
		18	131*	162*	-	-
		20	117	144*	161*	-
42 m	24 m	22	105	130*	152*	-
		24	95	118	141*	144*
		26	87	108	130*	138*
		28	80	100	120*	133*
		30	74	93	111	120*
		20	115*	130*	-	-
	36 m	22	109*	128*	130*	-
		24	93	116*	130*	-
		26	85	107*	125*	-
		28	78	98*	118*	119*
		30	72	91	109*	114*
		34	61	79	95*	106*
48 m	36 m	38	53	70	84	90
		42	46	62	71	-
		24	92*	93*	-	-
		26	84*	93*	-	-
		28	77	93*	-	-
		30	71	89*	93*	-
	60 m	34	60	77	93*	-
		38	52	68	82	91*
		42	45	60	73	81
		46	39	54	66	69
		50	35	49	58	-
		28	68	-	-	-
60 m	24 m	30	68	-	-	-
		34	58	68	-	-
		38	50	66	68	-
		42	43	59	66	-
		46	37	52	64	-
		50	33	47	56	-
	36 m	54	29	43	53	-
		58	26	39	46	-
		62	23	36	39	-

\* Doppelunterflasche erforderlich!

\* Double hook block required!

\* Necessario bozzello doppio!



Tragfähigkeiten wippbarer Hilfsausleger mit Superlift  
 Lifting capacities luffing fly jib with Superlift  
 Portate falcone a volata variabile con Superlift

**SWSL**

 **14 x 14 m**  **149 t SL-Radius 13 m** **75% 360°**

Hauptausleger Main Boom Braccio base	Hilfsausleger Fly Jib Falcone	Ausladung Radius Sbraccio	Superlift-Gegengewicht · Superlift Counterweight · Contrappeso Superlift			
			0 t	50 t	100 t	150 t
m	m	t	t	t	t	t
		34	54	-	-	-
		38	50	54	-	-
		42	43	53	-	-
		46	38	51	-	-
		50	33	47	-	-
	<b>72 m</b>	54	29	43	-	-
		58	26	39	-	-
		62	23	35	-	-
		66	20	32	-	-
		70	16	29	-	-
		74	15	26	-	-
<b>42 m</b>		38	39	-	-	-
		42	36	-	-	-
		46	30	-	-	-
		50	26	-	-	-
		54	22	-	-	-
	<b>84 m</b>	58	18	-	-	-
		62	16	-	-	-
		66	13	-	-	-
		70	11	-	-	-
		74	9	-	-	-
		78	8	-	-	-
		82	6	-	-	-
		86	5	-	-	-
		18	127*	158*	165*	-
		20	113*	141*	163*	-
		22	102*	127*	152*	157*
	<b>24 m</b>	24	93	116*	139*	147*
		26	85	106*	127*	138*
		28	78	96*	117*	129*
		30	72	90	109*	122*
		22	100*	117*	-	-
		24	91*	114*	117*	-
		26	83*	104*	117*	-
	<b>36 m</b>	28	76	96*	115*	116*
		30	70	88*	107*	110*
		34	60	77	93*	98*
		38	51	68	82	89*
		42	45	60	73	75
		26	81*	85*	-	-
		28	75*	85*	-	-
		30	69	85*	-	-
		34	59	76*	85*	-
	<b>48 m</b>	38	50	66	80*	85*
		42	44	59	72*	84*
		46	38	53	65	71*
<b>54 m</b>		50	33	48	59	60
		54	30	43	50	-
		30	61	-	-	-
		34	56	61	-	-
		38	48	61	-	-
		42	42	57	61	-
	<b>60 m</b>	46	36	51	60	-
		50	32	46	56	-
		54	28	42	52	-
		58	25	38	47	-
		62	22	35	41	-
		34	46	-	-	-
		38	46	-	-	-
		42	42	49	-	-
		46	36	47	-	-
	<b>72 m</b>	50	32	46	-	-
		54	28	43	-	-
		58	24	38	-	-
		62	22	35	-	-
		66	19	31	-	-
		70	17	28	-	-
		74	15	26	-	-

\* Doppelunterflasche erforderlich!

\* Double hook block required!

\* Necessario bozzello doppio!

# Tragfähigkeiten wippbarer Hilfsausleger mit Superlift

## Lifting capacities luffing fly jib with Superlift

### Portate falcone a voltata variabile con Superlift

# SWSL

 14 x 14 m



149 t SL-Radius 13 m

75% 360°

		Superlift-Gegengewicht · Superlift Counterweight · Contrappeso Superlift				
Hauptausleger Main Boom Braccio base	Hilfsausleger Fly Jib Falcone	Ausladung Radius Sbraccio	0 t	50 t	100 t	150 t
m	m	m	t	t	t	t
54 m	84 m	38	33	-	-	-
		42	33	-	-	-
		46	31	-	-	-
		50	26	-	-	-
		54	22	-	-	-
		58	19	-	-	-
		62	16	-	-	-
		66	14	-	-	-
		70	11	-	-	-
		74	10	-	-	-
		78	8	-	-	-
		82	7	-	-	-
		86	5	-	-	-
		66 m	60 m	20	110*	137*
22	99*			124*	138*	-
24	89*			112*	132*	-
26	82			103*	124*	125*
28	75			95*	114*	119*
30	68			88*	106*	114*
32	62			82*	100*	105*
34	58			77*	95*	100*
36	54			73*	91*	96*
38	50			69*	87*	92*
40	47			66*	84*	89*
42	44			63*	81*	86*
44	41			60*	78*	83*
46	38			57*	75*	80*
66 m	72 m	26	76*	-	-	-
		28	72*	76*	-	-
		30	66	76*	-	-
		34	57	73*	76*	-
		38	48	64	76*	-
		42	42	57	70	76*
		46	36	51	63	74*
		50	32	46	57	62
		54	28	42	52	-
		58	24	38	48	-
		62	20	34	44	-
		66	16	30	40	-
		70	12	26	36	-
		74	8	22	32	-
66 m	84 m	30	55	-	-	-
		34	55	55	-	-
		38	46	55	-	-
		42	40	55	55	-
		46	35	49	55	-
		50	30	44	54	-
		54	27	40	50	-
		58	24	37	46	-
		62	21	33	42	-
		66	18	31	38	-
		70	15	28	35	-
		74	12	25	32	-
		78	9	22	29	-
		82	7	19	26	-
86	5	16	23	-		

\* Doppelunterflasche erforderlich!



\* Double hook block required!

\* Necessario bozzello doppio!

# Tragfähigkeiten wippbarer Hilfsausleger mit Superlift **SWSL**

## Lifting capacities luffing fly jib with Superlift

### Portate falcone a volata variabile con Superlift

 **14 x 14 m**  **149 t SL-Radius 13 m** **75% 360°**

		Superlift-Gegengewicht · Superlift Counterweight · Contrappeso Superlift				
Hauptausleger Main Boom Braccio base	Hilfsausleger Fly Jib Falcone	Ausladung Radius Sbraccio	0 t	50 t	100 t	150 t
m	m	m	t	t	t	t
<b>48 m</b>		28	59	-	-	-
		30	59	-	-	-
		34	58	-	-	-
		38	49	57	-	-
		42	42	55	-	-
		46	37	52	-	-
		50	32	48	-	-
		54	29	44	-	-
		34	44	-	-	-
		38	44	-	-	-
<b>60 m</b>		42	40	43	-	-
		46	35	42	-	-
		50	31	41	-	-
		54	27	39	-	-
		58	24	36	-	-
		62	21	33	-	-
		66	19	30	-	-
		28	47	-	-	-
		30	47	-	-	-
		34	46	-	-	-
<b>48 m</b>		38	46	-	-	-
		42	40	43	-	-
		46	35	41	-	-
		50	30	38	-	-
		54	27	37	-	-
		34	35	-	-	-
		38	35	-	-	-
		42	35	-	-	-
		46	33	-	-	-
		50	29	33	-	-
<b>60 m</b>		54	25	31	-	-
		58	22	29	-	-
		62	20	27	-	-
		66	17	25	-	-

Tragfähigkeiten wippbarer Hilfsausleger mit Superlift  
 Lifting capacities luffing fly jib with Superlift  
 Portate falcone a volata variabile con Superlift

**SWSL**

 **15,5 x 15,5 m**  **149 t** **SL-Radius 13/15 m** **75%** **360°**

		Superlift-Gegengewicht · Superlift Counterweight · Contrappeso Superlift				
Hauptausleger Main Boom Braccio base	Hilfsausleger Fly Jib Falcone	Ausladung Radius Sbraccio	0 t	50 t	100 t	150 t
m	m	m	t	t	t	t
		34	34	-	-	-
		36	33	-	-	-
		42	33	-	-	-
		46	33	-	-	-
		50	28	33	-	-
	<b>72 m</b>	54	25	32	-	-
		56	22	30	-	-
		62	19	28	-	-
		66	16	25	-	-
		70	14	23	-	-
		74	13	21	-	-
		76	11	19	-	-
		38	23	-	-	-
		42	23	-	-	-
		46	23	-	-	-
		50	23	-	-	-
		54	22	-	-	-
		56	20	-	-	-
<b>78 m</b>	<b>84 m</b>	62	17	-	-	-
		66	14	-	-	-
		70	12	-	-	-
		74	10	-	-	-
		78	8	-	-	-
		82	7	-	-	-
		86	5	-	-	-
		90	4	-	-	-
		42	16	-	-	-
		46	16	-	-	-
		50	16	-	-	-
		54	16	-	-	-
		58	15	-	-	-
	<b>90 m</b>	62	15	-	-	-
		66	13	-	-	-
		70	11	-	-	-
		74	9	-	-	-
		78	7	-	-	-
		82	6	-	-	-
		86	5	-	-	-
		38	28	-	-	-
		42	28	-	-	-
		46	27	-	-	-
		50	26	-	-	-
	<b>72 m</b>	54	23	25	-	-
		58	20	23	-	-
		62	17	22	-	-
		66	15	21	-	-
		70	13	19	-	-
		74	11	18	-	-
		78	10	17	-	-
		42	20	-	-	-
		46	19	-	-	-
		50	19	-	-	-
		54	18	-	-	-
		58	17	-	-	-
		62	16	-	-	-
<b>90 m</b>	<b>84 m</b>	66	14	-	-	-
		70	12	-	-	-
		74	10	-	-	-
		78	8	-	-	-
		82	7	-	-	-
		86	6	-	-	-
		90	4	-	-	-
		42	13	-	-	-
		46	13	-	-	-
		50	13	-	-	-
		54	13	-	-	-
		58	13	-	-	-
	<b>90 m</b>	62	13	-	-	-
		66	12	-	-	-
		70	11	-	-	-
		74	9	-	-	-
		78	8	-	-	-
		82	6	-	-	-
		86	5	-	-	-

## Fahrgestell

	7-achsiges Kranträgerfahrgestell Typ: K 7306, Hersteller: Mannesmann Demag
<b>Rahmen:</b>	Längsträgerkonstruktion mit kesselförmigem Zentralteil aus hochfestem Feinkornbaustahl.
<b>Abstützung:</b>	4 teleskopierbare Stützträger aus Feinkornbaustahl, sternförmig mit Bolzen am Zentralteil befestigt. Stützbasis 11 x 11, 14 x 14 m und 15,5 x 15,5 m, Hydraulische Stützzylinder.
<b>Antrieb:</b>	Daimler-Benz-Dieselmotor Typ OM 443LA, 401 kW (545 PS) bei 2100 U/min nach DIN 70020, wassergekühlt. Kombination aus Drehmomentwandler und Schaltkupplung ZF (WSK 400), 16-Gang-Synchronschaltgetriebe. Verteilergetriebe mit sperrbarem Differential, 4 angetriebene Achsen.
<b>Lenkung:</b>	2-Kreis-Hydro-Halbblocklenkung
<b>Bremsanlage:</b>	Die Bremsanlage ist nach den EG-Richtlinien ausgelegt. 2-Kreis-Druckluft-Betriebsbremse. Federspeicher-Hilfs- und Feststellbremse. Dauerbremse: Kombination aus hydraulischem Retarder (Strömungsbremse) und Auspuffklappenbremse.
<b>Fahrerhaus:</b>	Elastisch gelagerte Low-Line-Kabine aus Stahlblech, rundum Sicherheitsverglasung, 2 gefederte und hydraulisch gedämpfte Sitze, motorabhängige Heizung.

## Oberwagen

<b>Gegengewicht:</b>	149 t
<b>Rahmen:</b>	Verformungssteife Schweißkonstruktion aus hochfestem Feinkornbaustahl. Verbindung zum Unterwagen durch 3-reihige Rollendrehverbindung.
<b>Antrieb:</b>	Daimler-Benz-Dieselmotor Typ OM 442, 213 kW (290 PS) bei 2100 U/min nach DIN 70020, wassergekühlt. Pumpenverteilergetriebe mit 3 verstellbaren Axialkolbenpumpen, davon eine mit angeflanschter Dreifachzahnradpumpe.
<b>Seilwinden:</b>	Der Oberwagen ist serienmäßig mit 4 Seilwinden – Hubwerk 1, Hubwerk 2, Einziehwerk und Wippwerk – ausgerüstet. Der Antrieb der Winden erfolgt durch Hydromotoren über geschlossene, ölbadgeschmierte Planetengetriebe. Alle Seilwinden sind mit federbelasteten, hydraulisch gelüfteten Lamellenbremsen und verschleißfreier, hydraulischer Bremsung für den Senkvorgang ausgerüstet.
<b>Drehwerk:</b>	Ein Drehwerk mit Antrieb durch Hydromotor über geschlossenes, ölbadgeschmiertes Planetengetriebe. Federbelastete, hydraulisch gelüftete Haltebremse und verschleißfreie hydraulische Bremsung.
<b>Steuerung:</b>	Hydraulische Servosteuerung.
<b>Kabine:</b>	Komfortkabine mit großem Frontfenster. Sicherheitsverglasung rundum, Dachfenster, motorunabhängige Warmluftheizung sowie Steuer- und Kontrollelemente für die Kranfunktionen. Während des Transportes ist die Kabine vor den Oberwagen geschwenkt.

## Auslegervarianten S und L

<b>SH:</b>	Hauptausleger: Fußstück 3,5 m, Fußanschlußstück 5,85 m (geeignet zum Einbau der Winde W1/H3), Zwischenstücke 12 m und 6 m (Typ 700), Universalspitze 8,65 m. Hauptauslegerlängen: 18-90 m
<b>SW:</b>	Hauptausleger: wie SH Hilfsausleger: Fußstück 9,5 m, Zwischenstücke 12 m und 6 m (Typ 600), Universalspitze 8,5 m. Hauptauslegerlängen: 30-60 m Hilfsauslegerlängen: 24-60 m
<b>SSL:</b>	Hauptausleger: wie SH Mast 30 m, Superliftgegengewicht 50-250 t Hauptauslegerlängen: 30-90 m
<b>SWSL:</b>	Hauptausleger: wie SH Hilfsausleger: wie SW Mast 30 m, Superliftgegengewicht 50-150 t Hauptauslegerlängen: 30-90 m Hilfsauslegerlängen: 24-90 m
<b>Sicherheits-einrichtungen:</b>	Elektronischer Lastmomentbegrenzer, Hubendschalter, Endschalter für Auslegerbewegungen, hydraulische Ausleger-Rückfallsicherungen, Windmesser.

Die Superlift-Gegengewichte und der Superlift-Tragrahmen gehören nicht zum Lieferumfang.

## Carrier

7-axle crane carrier type K 7306, manufactured by Mannesmann Demag.

<b>Frame:</b>	Longitudinal beam construction with pot-shaped centre piece fabricated from high-strength fine-grained structural steel.
<b>Outriggers:</b>	4 telescopic outrigger beams made from fine-grained structural steel, pinned to centre piece in star formation. Outrigger base 11 x 11, 14 x 14 and 15.5 x 15.5 m. Hydraulic jacking cylinders.
<b>Drive:</b>	Daimler-Benz diesel engine type OM 443LA, 401 kW (545 HP) at 2100 rpm to DIN 70020, water-cooled. Combination of torque converter and separating clutch ZF (WSK 400), 16-speed synchromesh transmission. Transfer case with differential lock-out. 4 drive axles.
<b>Steering:</b>	Dual circuit semiblock mechanical steering with hydraulic booster.
<b>Braking System:</b>	In compliance with EC regulations. Dual-line air-operated service brake. Spring-loaded auxiliary and parking brake. Sustained-action brake: Combination of hydraulic retarder (hydrodynamic brake) and exhaust brake.
<b>Operator's Cab:</b>	Rubber-mounted low-line all-steel cab, safety glazing all around, 2 sprung and hydraulically damped seats, engine-dependent heater.

## Superstructure

<b>Counterweight:</b>	149 t
<b>Frame:</b>	Torsion-resistant welded structure made from fine-grained structural steel. Connected to carrier by triple-row roller bearing slew ring.
<b>Drive:</b>	Daimler Benz diesel engine, type OM 442LA, 353 kW (480 HP) at 2100 rpm to DIN 70020, water-cooled. Pump distribution gearbox with 3 variable displacement axial piston pumps and flanged triple gear pump.
<b>Rope Drums:</b>	The standard superstructure equipment includes 4 rope drums – hoist 1, hoist 2, boom hoist and luffing hoist. The drums are driven by hydraulic motors through closed planetary gear units running in oil bath. All rope drums have spring applied, hydraulically released multi-disk brakes and wear-free hydraulic braking for load lowering.
<b>Slew System:</b>	Driven by hydraulic motor through closed planetary gear unit running in oil bath. Spring applied, hydraulically released holding brake and wear-free hydraulic braking.
<b>Control:</b>	Hydraulic servo-control.
<b>Cab:</b>	Comfortable cab with large windscreen. Safety glazing all around, roof window, self-contained air heater, and crane controls and instrumentation. The cab is swung in front of the superstructure for road travel.

## Boom Variants S and L

<b>SH:</b>	Main boom: foot section 3.5 m, foot adapter piece 5.85 m (to accommodate winch W1/H3), inserts 12 m and 6 m type 700, and universal head 8.65 m. Main boom lengths: 18-90 m.
<b>SW:</b>	Main boom: same as SH Fly jib: foot section 9.5 m, inserts 12 m and 6 m type 600, and universal head 8.5 m. Main boom lengths: 30-60 m Fly jib lengths: 24-60 m.
<b>SSL:</b>	Main boom: same as SH Mast 30 m, Superlift counterweight 50-250 t, Main boom lengths: 30-90 m
<b>SWSL:</b>	Main boom: same as SH Fly jib: same as SW Mast 30 m, Superlift counterweight 50-150 t Main boom lengths: 30-90 m Fly jib lengths: 24-90 m
<b>Safety Devices:</b>	Electronic safe load indicator, hoist limit switches, limit switches for boom movements, hydraulic boom backstops, anemometer.

The Superlift counterweight and the Superlift tray are not included in the scope of supply.

## Carro

	tipo K 7306 su 7 assi costruito dalla Mannesmann Demag.
<b>Telaio:</b>	a longheroni con parte centrale cilindrica realizzata in carpenteria d'acciaio a fine granalatura ad alta resistenza di snervamento.
<b>Stabilizzatori:</b>	a stella, composti da 4 travi telescopiche realizzate in carpenteria d'acciaio a fine granalatura ad alta resistenza di snervamento fissate alla parte cilindrica centrale tramite perni. Base d'appoggio 11 x 11, 14 x 14 e 15,5 x 15,5 m. Cilindri stabilizzatori idraulici.
<b>Trazione:</b>	motore diesel Daimler Benz OM 443LA, 401 kW (545 CV) a 2100 giri/min secondo DIN 70020 raffreddato ad acqua. Convertitore di coppia con frizione di scambio tipo ZF (WSK 400), cambio sincronizzato a 16 marce. Riduttore di distribuzione e differenziale bloccabile. Assi trainati 4.
<b>Sterzo:</b>	a doppio circuito assistito idraulicamente.
<b>Freni:</b>	secondo le norme CEE. freno di servizio pneumatico a doppio circuito freno di soccorso e di stazionamento, comando a molla freno continuo: combinazione di freno idrodinamico (retarder) con freno sul tubo di scappamento.
<b>Cabina:</b>	cabina low line d'acciaio a sospensione elastica, vetratura con vetri di sicurezza, 2 sedili molleggiati su sospensioni idrauliche, riscaldamento dipendente dal motore diesel.

## Torretta

<b>Contrappeso:</b>	149 t
<b>Telaio:</b>	in carpenteria d'acciaio a fine granalatura ad alta resistenza di snervamento. Ralla a 3 file di rulli quale giunzione tra torretta e carro.
<b>Trazione:</b>	motore diesel Daimler Benz tipo OM 442LA, 353 kW (480 CV) a 2100 giri/min. Riduttore di distribuzione con 3 pompe idrauliche a portata variabile a pistoni assiali una delle quali con 1 pompa tripla ad ingranaggi sulla flangia.
<b>Argani:</b>	la torretta è equipaggiata standard con 4 argani - argano 1, argano 2, argano sollevamento braccio base, argano brandeggio falcone. La trazione degli argani avviene tramite motori idraulici trainanti riduttori epicicloidali a bagno d'olio. Tutti gli argani sono provvisti di un sistema di freni multidisco comandati a molla e liberati idraulicamente con frenatura idraulica senza usure durante la discesa del bozzello.
<b>Rotazione:</b>	azionata tramite motore idraulico con riduttore epicicloidale a bagno d'olio. Freno d'arresto comandato da molla e sciolto idraulicamente. Frenatura idraulica senza usure.
<b>Comando:</b>	servocomando idraulico.
<b>Cabina:</b>	cabina confortabile con larga vetratura di sicurezza, tetto con finestra, riscaldamento ad aria autonoma, organi di comando e di controllo. Durante il trasporto su strada, la cabina viene ruotata sulla parte anteriore della torretta.

## Varianti d'equipaggiamenti tipo S ed L

<b>SH:</b>	braccio base pesante: piede 3,5 m, adattatore per piede 5,85 m (su tale segmento viene montato l'argano W1/H3), segmenti da 12 m e 6 m tipo 700, testa 8,65 m. Lunghezza braccio base pesante: 18-90 m.
<b>SW:</b>	braccio base pesante identico ad SH falcone: piede 9,5 m, segmenti da 12 m e 6 m tipo 600, testa falcone 8,5 m. Lunghezza braccio base: 30-60 m Lunghezza falcone: 24-60 m
<b>SSL:</b>	braccio base pesante identico ad SH Mast 30 m, contrappeso Superlift: 50-250 t Lunghezza braccio base: 30-90 m
<b>SWSL:</b>	braccio base pesante identico ad SH falcone identico a SW Mast 30 m, contrappeso Superlift: 50-150 t Lunghezza braccio base: 30-90 m Lunghezza falcone: 24-90 m
<b>Sicurezze:</b>	limitatore elettronico di carico, finecorsa bozzello, finecorsa movimento braccio, cilindri antiribaltamento braccio, anemometro.

I contrappesi e la piastra base Superlift non fanno parte della fornitura.