

HYDRAULIC CRAWLER CRANE

KOBELCO

CKE1800

Max. Lifting Capacity: 180 t
Max. Boom Length: 85.3 m
Max. Jib Length: 30.5 m
Max. Luffing Jib: 51.8 m

S P E C I F I C A T I O N S

Heavy Duty Boom	
Max. Lifting Capacity	180 t/3.75 m
Max. Length	12.2 m
Standard Crane Boom	
Max. Lifting Capacity	160 t/4.4 m
Max. Length	85.3 m
Luffing Main Boom	
Max. Lifting Capacity	110 t/5.2 m
Max. Length	54.9 m
Long Boom	
Max. Lifting Capacity	40.1 t/12 m
Max. Length	61.0~85.3 m
Fixed Jib	
Max. Lifting Capacity	26.8 t
Max. Length	30.5 m
Max. Combination	73.2 m + 30.5 m
Luffing Jib	
Max. Lifting Capacity	48.5 t/9.14 m
Length	21.3 m ~ 51.8 m
Combination	21.3 m ~ 54.9 m + 51.8 m
Luffing Angle	60° ~ 88°
Power Plant	
Model	Mitsubishi 6D24-TLU2D
Engine Output	235 kW/2,000 rpm
Fuel Tank Capacity	400 liters

Main & Aux. Winch	
Max. Line Speed	100 m/min (1st layer)
Rated Line Pull	132 kN (13.4 tf)
Max. Line Pull	245 kN (25.0 tf) (1st layer)
Wire Rope Diameter	25 mm
Wire Rope Length	430 m (main) 335 m (aux.)
Brake Type	Wet-type multiple disc brake
Free Fall	Option
Working Speed	
Swing	2.6 min ⁻¹ (rpm)
Travel	1.1/0.7 km/h
Hydraulic System	
Pumps	3 variable displacement
Max. Pressure	31.9 MPa (325 kg/cm ²)
Hydraulic Tank Capacity	550 liters
Self Erection Device	
	Standard
Weight	
Operating Weight	Approx. 164 t
Counterweight	60.6 t (upper) + 20.0 t (lower)
Transportation Weight	43.1 t (with trans lifter)
Ground Pressure (Ave.)	91 kPa (0.93 kgf/cm ²)

GENERAL DIMENSIONS

Unit: mm

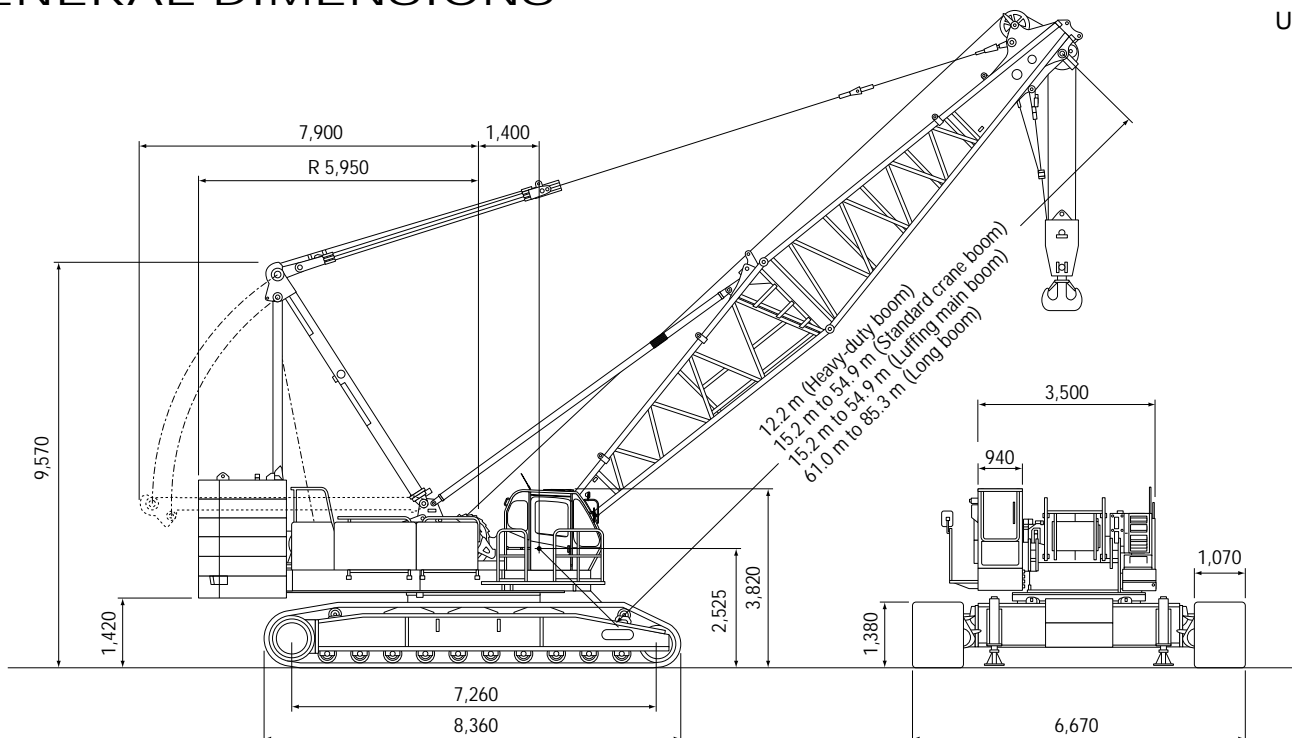

KOBELCO CRANES CO., LTD.

BOOM & JIB ARRANGEMENT

CRANE BOOM ARRANGEMENT

Boom length m (ft)	Boom arrangement
15.2 (50)	Base-Tip
18.3 (60)	Base-A-Tip
21.3 (70)	Base-A-A-Tip, Base-B-Tip
24.4 (80)	Base-A-B-Tip, Base-C-Tip
27.4 (90)	Base-A-A-B-Tip, Base-A-C-Tip
30.5 (100)	Base-A-A-C-Tip, Base-B-C-Tip
33.5 (110)	Base-A-B-C-Tip, Base-C-C-Tip
36.6 (120)	Base-A-A-B-C-Tip, Base-A-C-C-Tip
39.6 (130)	Base-A-A-C-C-Tip, Base-A-B-B-C-Tip, Base-B-C-C-Tip
42.7 (140)	Base-A-B-C-C-Tip, Base-A-A-B-B-C-Tip, Base-C-C-C-Tip
45.7 (150)	Base-A-A-B-C-C-Tip, Base-B-B-C-C-Tip, Base-A-C-C-C-Tip
48.8 (160)	Base-A-A-C-C-C-Tip, Base-A-B-B-C-C-Tip, Base-B-C-C-C-Tip
51.8 (170)	Base-C-C-C-C-Tip, Base-A-B-C-C-C-Tip, Base-A-A-B-B-C-C-Tip
54.9 (180)	Base-A-A-B-C-C-C-Tip, Base-A-C-C-C-C-Tip, Base-B-B-C-C-C-Tip
57.9 (190)	Base-A-A-C-C-C-C-Tip, Base-A-B-B-C-C-C-Tip, Base-B-C-C-C-C-Tip
61.0 (200)	Base-A-B-C-C-C-C-Tip, Base-A-A-B-B-C-C-C-Tip
64.0 (210)	Base-A-B-C-C-C-D-Tip, Base-A-A-B-B-C-C-D-Tip, Base-C-C-C-C-D-Tip
67.1 (220)	Base-A-A-B-C-C-C-D-Tip, Base-A-C-C-C-C-D-Tip, Base-B-B-C-C-C-D-Tip
70.1 (230)	Base-A-A-C-C-C-C-D-Tip, Base-A-B-B-C-C-C-D-Tip, Base-B-C-C-C-C-D-Tip
73.2 (240)	Base-A-B-C-C-C-C-D-Tip, Base-A-A-B-B-C-C-C-D-Tip
76.2 (250)	Base-A-B-C-C-C-D-D-Tip, Base-A-A-B-B-C-C-D-D-Tip, Base-C-C-C-C-D-D-Tip
79.3 (260)	Base-A-A-B-C-C-C-D-D-Tip, Base-A-C-C-C-C-D-D-Tip, Base-B-B-C-C-C-D-D-Tip
82.3 (270)	Base-A-A-C-C-C-C-D-D-Tip, Base-A-B-B-C-C-C-D-D-Tip, Base-B-C-C-C-C-D-D-Tip
85.3 (280)	Base-A-B-C-C-C-C-D-D-Tip

Base Boom Length and Boom Tip Length
Base = 8.8 m (29'), Tip = 7.4 m (24')

Insert Boom
A = 3.0 m (10'), B = 6.1 m (20'), C = 9.1 m (30'),
D = 12.2 m (40')

FIXED JIB ARRANGEMENT

Jib length m (ft)	Jib arrangement
12.2 (40)	Base-A-Tip
18.3 (60)	Base-A-B-Tip
24.4 (80)	Base-A-B-B-Tip
30.5 (100)	Base-A-B-B-B-Tip

Base Jib Length and Jib Tip Length
Base = 5.1 m (17'), Tip = 5.0 m (16')

Insert Jib
A = 3.0 m (10'), B = 6.1 m (20')
The length of the boom to which the jib is attached is 24.4 m to 73.2 m.

LONG BOOM ARRANGEMENT

Boom length m (ft)	Boom arrangement
61.0 (200)	Base-A-A-C-C-C-T-Ltip
64.0 (210)	Base-A-A-C-C-C-T-A1-Ltip
67.1 (220)	Base-A-A-C-C-C-T-A1-A1-Ltip, Base-A-A-C-C-C-T-B1-Ltip
70.1 (230)	Base-A-A-C-C-C-T-A1-B1-Ltip, Base-A-A-C-C-C-T-C1-Ltip
73.2 (240)	Base-A-A-C-C-C-T-A1-A1-B1-Ltip, Base-A-A-C-C-C-T-A1-C1-Ltip
76.2 (250)	Base-A-A-C-C-C-T-A1-A1-C1-Ltip, Base-A-A-C-C-C-T-B1-C1-Ltip
79.3 (260)	Base-A-A-C-C-C-T-A1-B1-C1-Ltip, Base-A-A-C-C-C-T-C1-C1-Ltip
82.3 (270)	Base-A-A-C-C-C-T-A1-A1-B1-C1-Ltip, Base-A-A-C-C-C-T-A1-C1-C1-Ltip
85.3 (280)	Base-A-B-C-C-C-T-A1-A1-B1-C1-Ltip, Base-A-B-C-C-C-T-A1-C1-C1-Ltip

Base Boom Length and Long Boom Tip Length

Base = 8.5 m (28'), Ltip = 6.1 m (20')
Insert Boom
A = 3.0 m (10'), B = 6.1 m (20'), C = 9.1 m (30'), A1 = 3.0 m (10'), B1 = 6.1 m (20'),
C1 = 9.1 m (30')
Taper Boom
T = 3.6 m (12')

LUFFING BOOM ARRANGEMENT FOR CRANE

Boom length m (ft)	Boom arrangement
15.2 (50)	Base-A-Cap
18.3 (60)	Base-A-A-Cap, Base-B-Cap
21.3 (70)	Base-A-B-Cap, Base-C-Cap
24.4 (80)	Base-A-A-B-Cap, Base-A-C-Cap
27.4 (90)	Base-A-A-C-Cap, Base-B-C-Cap
30.5 (100)	Base-A-B-C-Cap, Base-C-C-Cap
33.5 (110)	Base-A-A-B-C-Cap, Base-A-C-C-Cap
36.6 (120)	Base-A-A-C-C-Cap, Base-B-C-C-Cap
39.6 (130)	Base-A-B-C-C-Cap, Base-C-C-C-Cap
42.7 (140)	Base-A-A-B-C-C-Cap, Base-A-C-C-C-Cap
45.7 (150)	Base-A-A-C-C-C-Cap, Base-B-C-C-C-Cap
48.8 (160)	Base-A-B-C-C-C-Cap, Base-C-C-C-C-Cap
51.8 (170)	Base-A-A-B-C-C-C-Cap, Base-A-C-C-C-C-Cap
54.9 (180)	Base-A-A-C-C-C-C-Cap, Base-B-C-C-C-C-Cap

Base Boom Length and Luffing Boom Cap Length
Base = 8.5 m (28'), Cap = 3.6 m (12')

Insert Boom
A = 3.0 m (10'), B = 6.1 m (20'), C = 9.1 m (30')

LUFFING BOOM ARRANGEMENT FOR LUFFING

Boom length m (ft)	Boom arrangement
21.3 (70)	Base-A-B-Cap, Base-C-Cap
24.4 (80)	Base-A-A-B-Cap, Base-A-C-Cap
27.4 (90)	Base-A-A-C-Cap, Base-B-C-Cap
30.5 (100)	Base-A-B-C-Cap, Base-C-C-Cap
33.5 (110)	Base-A-A-B-C-Cap, Base-A-C-C-Cap
36.6 (120)	Base-A-A-C-C-Cap, Base-B-C-C-Cap
39.6 (130)	Base-A-B-C-C-Cap, Base-C-C-C-Cap
42.7 (140)	Base-A-A-B-C-C-Cap, Base-A-C-C-C-Cap
45.7 (150)	Base-A-A-C-C-C-Cap, Base-B-C-C-C-Cap
48.8 (160)	Base-A-B-C-C-C-Cap, Base-C-C-C-C-Cap
51.8 (170)	Base-A-A-B-C-C-C-Cap, Base-A-C-C-C-C-Cap
54.9 (180)	Base-A-A-C-C-C-C-Cap, Base-B-C-C-C-C-Cap

Base Boom Length and Luffing Boom Cap Length

Base = 8.5 m (28'), Cap = 3.6 m (12')
Insert Boom
A = 3.0 m (10'), B = 6.1 m (20'), C = 9.1 m (30')

LUFFING JIB ARRANGEMENT

Jib length m (ft)	Jib arrangement
21.3 (70)	Base-A1-B1-Ltip, Base-C1-Ltip
24.4 (80)	Base-A1-A1-B1-Ltip, Base-A1-C1-Ltip
27.4 (90)	Base-A1-A1-C1-Ltip, Base-B1-C1-Ltip
30.5 (100)	Base-A1-B1-C1-Ltip, Base-C1-C1-Ltip
33.5 (110)	Base-A1-A1-B1-C1-Ltip, Base-A1-C1-C1-Ltip
36.6 (120)	Base-A1-A1-C1-C1-Ltip, Base-B1-C1-C1-Ltip
39.6 (130)	Base-A1-B1-C1-C1-Ltip, Base-C1-C1-C1-Ltip
42.7 (140)	Base-A1-A1-B1-C1-C1-Ltip, Base-A1-C1-C1-C1-Ltip
45.7 (150)	Base-A1-A1-C1-C1-C1-Ltip, Base-B1-C1-C1-C1-Ltip
48.8 (160)	Base-A1-B1-C1-C1-C1-Ltip
51.8 (170)	Base-A1-A1-B1-C1-C1-C1-Ltip

Base Jib Length and Jib Tip Length

Base = 6.1 m (20'), Ltip = 6.1 m (20')
Insert Luffing Jib
A1 = 3.0 m (10'), B1 = 6.1 m (20'), C1 = 9.1 m (30')

WORKING RADIUS

CRANE BOOM

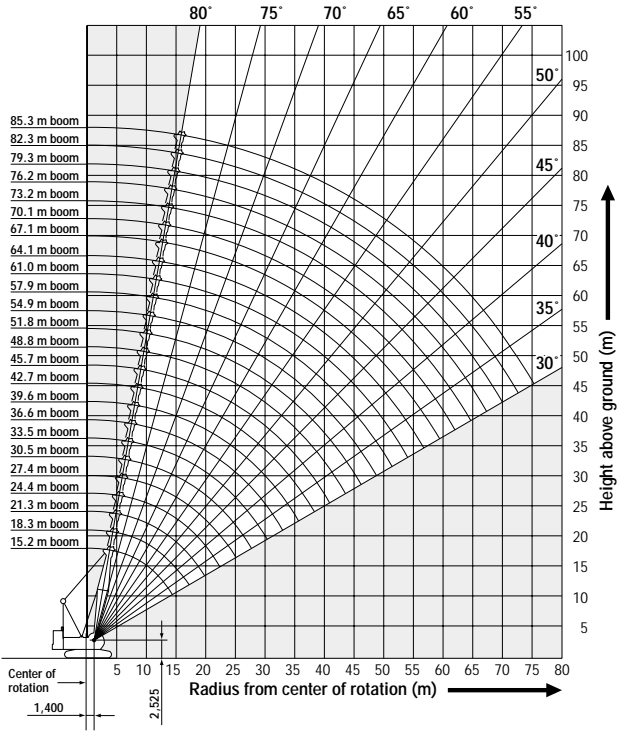

FIXED JIB (Jib Offset Angle: 10° + 30°)

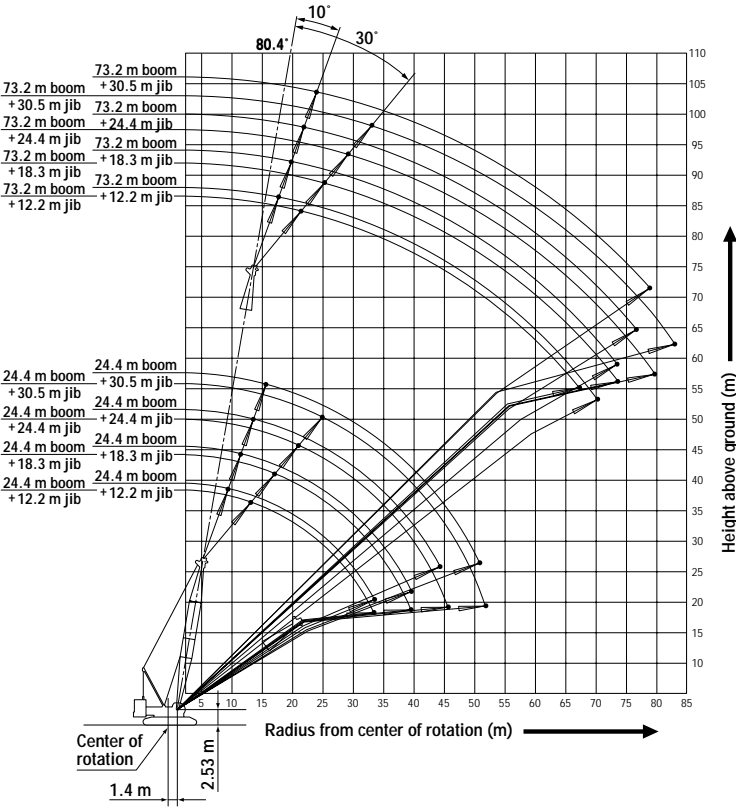

LUFFING JIB

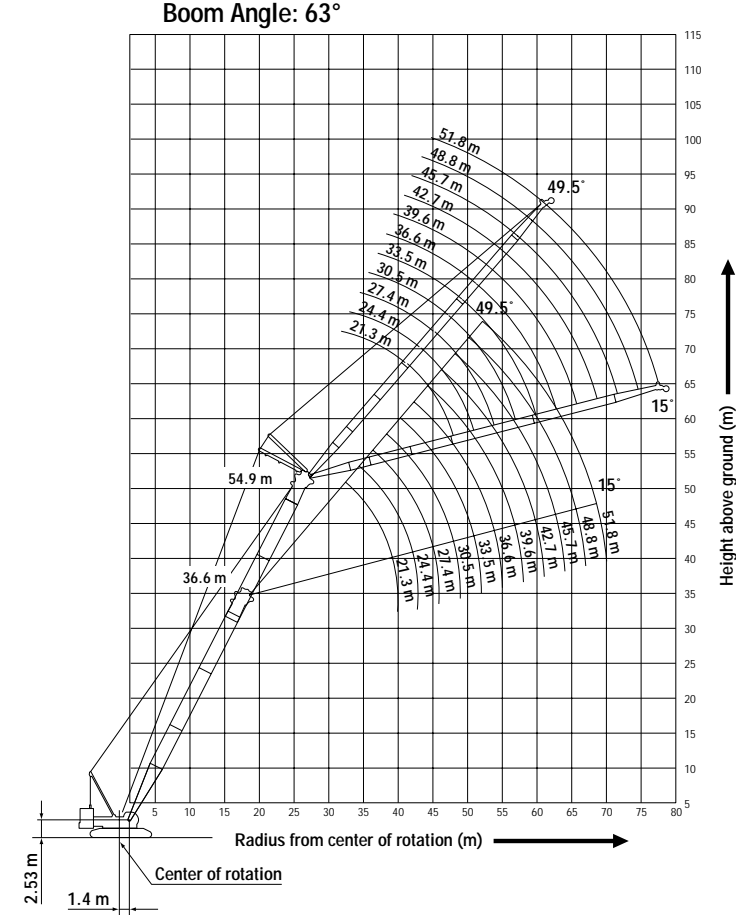
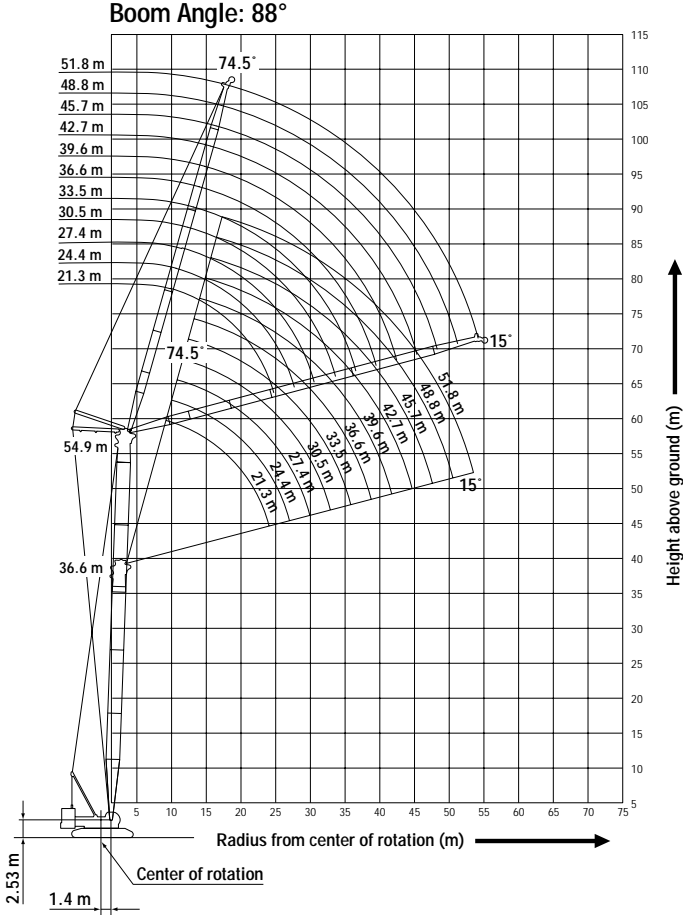

SPECIFICATIONS OF PARTS AND ATTACHMENTS

Dimensions: mm Weight: kg

Base Machine + Boom Base

Weight: 43,100 kg*, Width: 3,500 mm

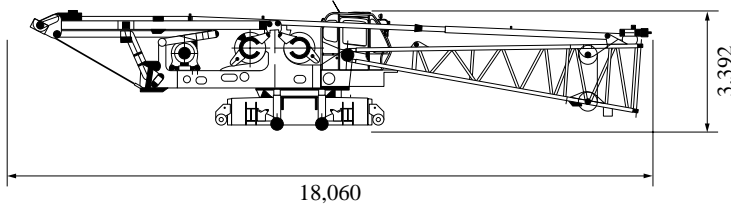

Crawler

Weight: 17,155 kg, Width: 1,070 mm

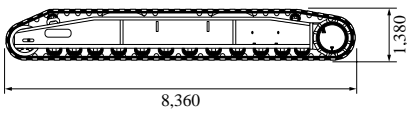

Gantry

Weight: 2,950 kg

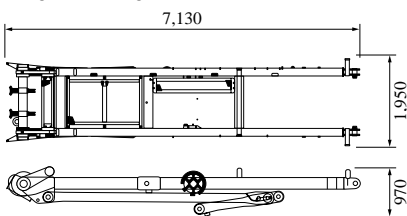

Counterweight (A)

Weight: 10,000 kg

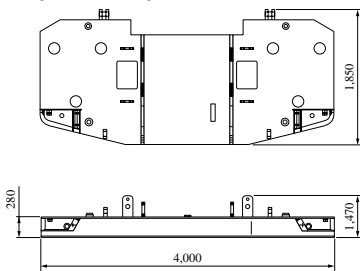

Counterweight (B)

Weight: 5,000 kg x 12 pieces

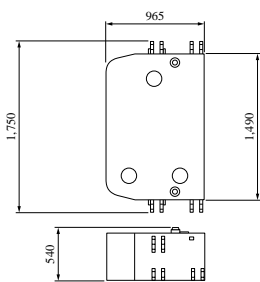

Carbody weight (A)

Weight: 5,000 kg x 2

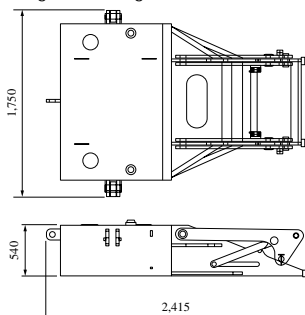

Boom Base

Weight: 2,620 kg

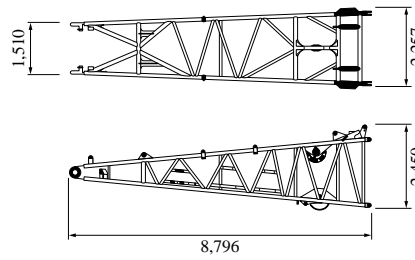

Boom Top

Weight: 2,240 kg (with Guy Cables)

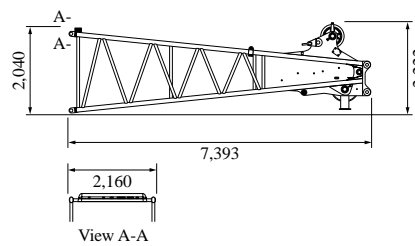

Insert Boom

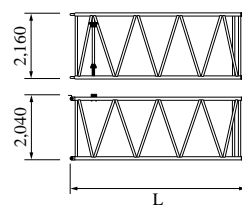

	L (mm)	Weight (kg)*
3.0 m	3,180	630 kg
6.1 m	6,230	1,028 kg
9.1 m	9,280	1,416 kg
12.2 m	12,320	1,682 kg

* with guy cables

Jib Base with Strut (For Crane)

Weight: 510 kg, Width: 1,040 mm

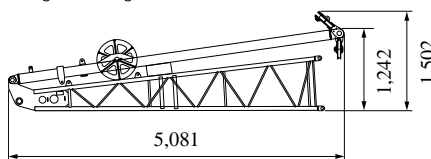

Jib Top (For Crane)

Weight: 315 kg

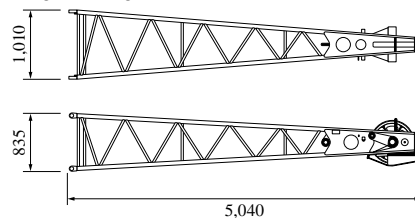

Travel Kit Assembly

Weight: 6,600 kg

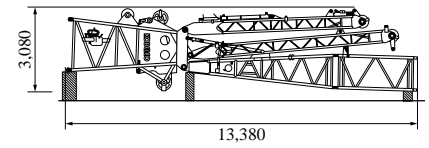

Luffing Upper Boom

Weight: 2,545 kg

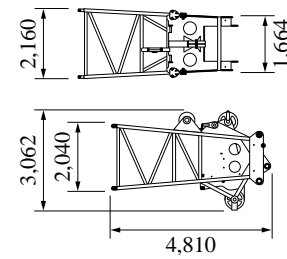

Luffing Jib Base

Weight: 1,140 kg

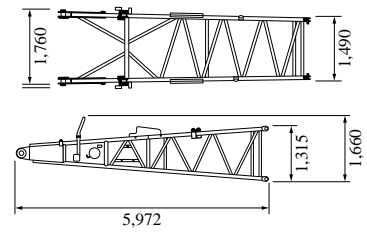

Luffing Jib Top

Weight: 1,170 kg

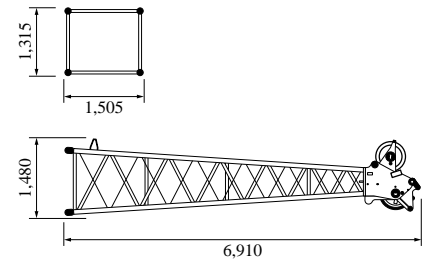

Front Strut (Luffing Jib)

Weight: 997 kg

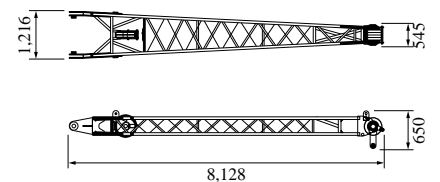

Rear Strut (Luffing Jib)

Weight: 1,088 kg

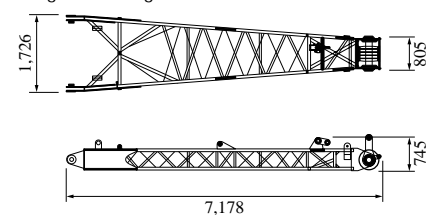

TRANSPORTATION PLAN

(Main Boom 54.9 m + Luffing Jib 51.8 m)

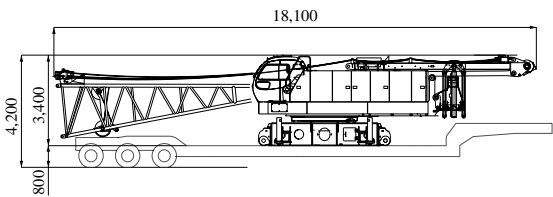
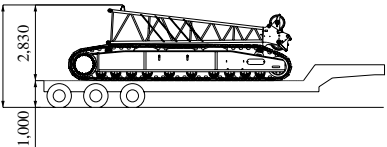
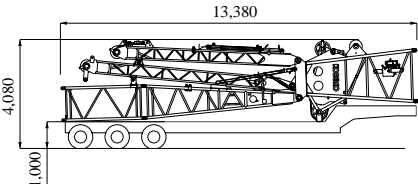
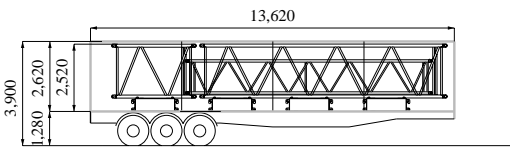
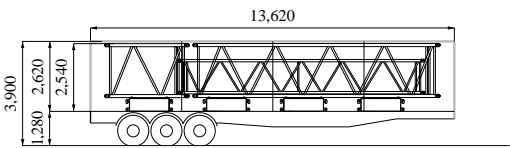
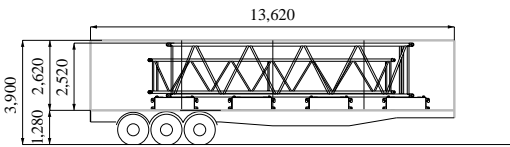
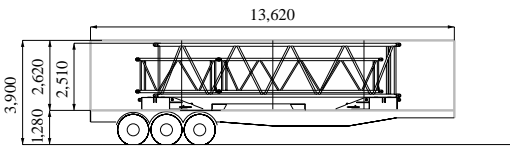
Configuration	Description	Total Weight
<p>No.1 Low Loader Width: 3,500 mm</p> 	<p>Base Machine = Including 3rd winch Translifter All wire ropes</p>	45.00 ton
<p>No.2 Semi Loader</p> 	<p>Crawler No.1 = Crawler No.2 = Luffing Jib Top = Total =</p>	<p>17.15 ton 17.15 ton 1.17 ton <hr/>35.47 ton</p>
<p>No.3 Semi Loader</p> 	<p>Travel Kit =</p>	6.60 ton
<p>No. 4 Tent Side Truck</p> 	<p>Counterweight (4 x 5.00 ton) = 30 ft Boom x 1 = 30 ft Jib x 1 = 10 ft Boom x 1 = Total =</p>	<p>20.00 ton 1.42 ton 0.74 ton 0.53 ton <hr/>22.69 ton</p>
<p>No.5 Tent Side Truck</p> 	<p>Counterweight (4 x 5.00 ton) = 30 ft Boom x 1 = 30 ft Jib x 1 = 10 ft Boom x 1 = Total =</p>	<p>20.00 ton 1.42 ton 0.74 ton 0.53 ton <hr/>22.69 ton</p>
<p>No.6 Tent Side Truck</p> 	<p>Counterweight (4 x 5.00 ton) = 30 ft Boom x 1 = 30 ft Jib x 1 = Total =</p>	<p>20.00 ton 1.42 ton 0.74 ton <hr/>22.16 ton</p>
<p>No.7 Tent Side Truck</p> 	<p>Counterweight Base = 30 ft Boom x 1 = 20 ft Jib x 1 = 10 ft Jib x 1 = Carbodyweight Base (2x5.00 ton) = Total =</p>	<p>10.00 ton 1.42 ton 0.45 ton 0.31 ton 10.00 ton <hr/>22.18 ton</p>

Note: This transport plan depends on your specification of trailer and the areas or countries where you transport.

OTHER ATTACHMENTS

CKE1800

Attachments	Weight	Dimensions (L x W x H)
Base machine (without base boom)	37,700 kg	10,400 mm x 3,800 mm x 3,390 mm
Translifter	360 kg	1,050 mm x 1,030 mm
Boom backstop	740 kg	7,086 mm x 360 mm
3.0 m (10 ft) Insert jib	110 kg	3,128 mm x 1,020 mm x 840 mm
6.1 m (20 ft) Insert jib	190 kg	6,175 mm x 1,020 mm x 840 mm
Auxiliary sheave	570 kg	1,670 mm x 1,660 mm
Upper spreader	590 kg	2,230 mm x 395 mm x 790 mm
Lower spreader	400 kg	1,500 mm x 290 mm x 780 mm
3.0 m (10 ft) Insert luffing jib	310 kg	3,165 mm x 1,490 mm x 1,290 mm
6.1 m (20 ft) Insert luffing jib	540 kg	6,210 mm x 1,490 mm x 1,290 mm
9.1 m (30 ft) Insert luffing jib	740 kg	9,280 mm x 1,490 mm x 1,290 mm
Luffing jib backstop	100 kg	2,943 mm x 226 mm
Strut backstop (luffing jib)	180 kg	2,888 mm x 268 mm
Auxiliary sheave (luffing jib)	380 kg	1,012 mm x 893 mm x 914 mm
Luffing jib drum	1,470 kg	840 mm x 1,616 mm x 900 mm
Ball hook	460 kg	1,200 mm x 380 mm dia.
35-ton hook	900 kg	1,575 mm x 365 mm x 700 mm
70-ton hook	1,200 kg	1,825 mm x 470 mm x 700 mm
100-ton hook	1,800 kg	2,025 mm x 555 mm x 700 mm
150-ton hook	2,300 kg	2,665 mm x 715 mm x 700 mm

Note: Due to our policy of continual product improvements all designs and specifications are subject to change without advance notice.



KOBELCO CRANES CO., LTD.

17-1, Higashigotanda 2-chome, Shinagawa-ku, Tokyo 141-8626 JAPAN
 Tel: ++81 (0) 3-5789-2130 Fax: ++81 (0) 3-5789-3372