

# QUY50

## Crawler Crane Technical Manual



Add: No. 613, 3<sup>rd</sup> section of Middle Fu Rong Rd Changsha City, Hunan Province, China  
Tel: +86-731-5667238  
Fax: +86-731-5682997  
E-mail: hotline-crane@zoomlion.com  
PC: 410007

2009 © Copyright by Zoomlion Heavy Industry Science & Technology. We reserve the right to make improvements and changes to our products without notice. If there are any differences between technical parameters given in the manual and product delivered for you, please refer to the product.

[www.zoomlion.com](http://www.zoomlion.com)

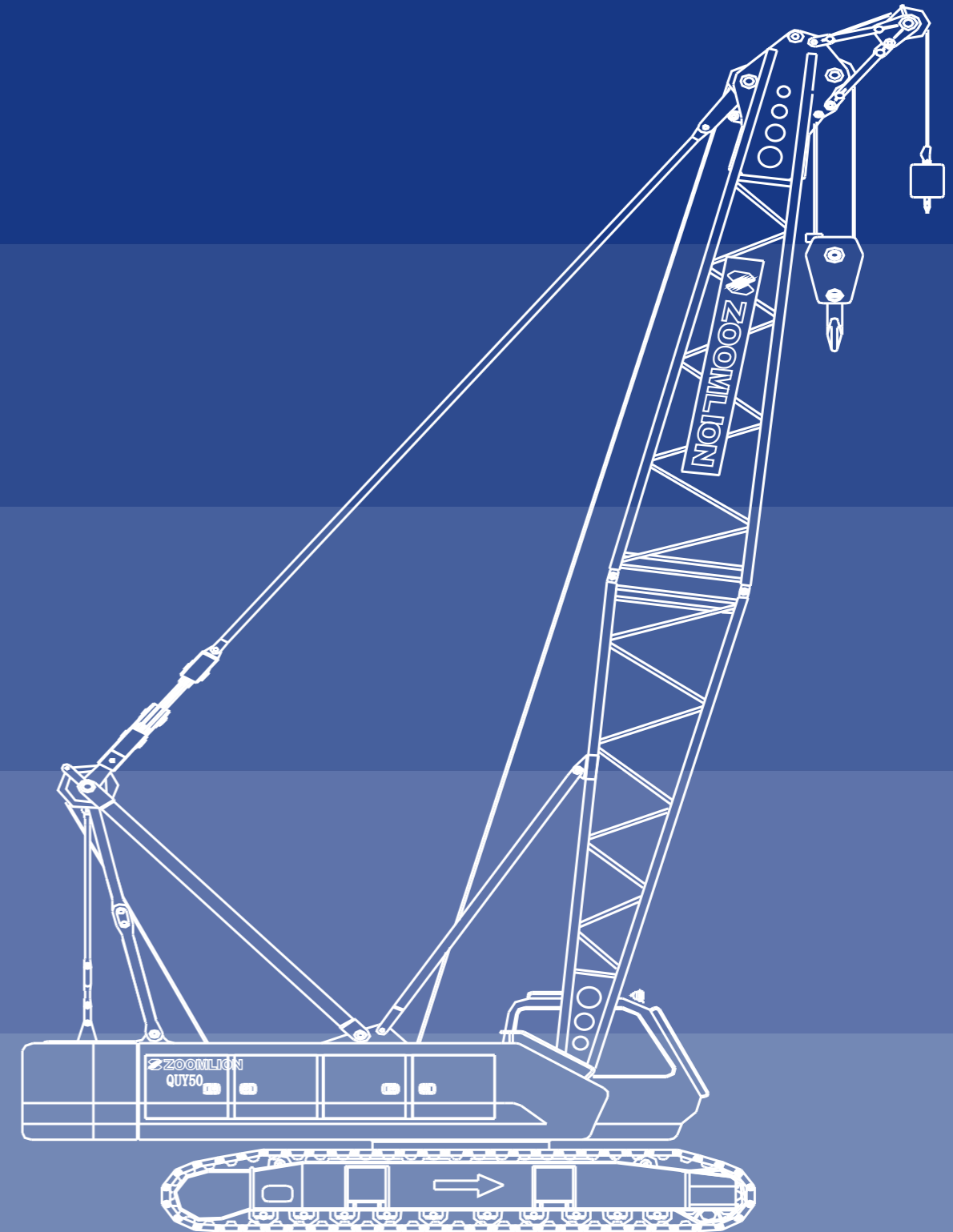

### **I. Overall dimensions and main parameters**

1 ) Overall dimensions of basic machine	01
2 ) Main technical parameters	02
3 ) Transport dimensions and weights of main components	03

### **II. Technical instruction**

4 ) Boom system	04
5 ) Working mechanism	04
6 ) Crane system	05
7 ) Safety equipment	06
8 ) Operator's cab	06
9 ) Load hook	06

### **III. Self-assembly & dismantling function 07**

### **IV. Lifting capacity**

10 ) Lifting performance on S boom	09
11 ) Lifting performance on SF boom	12

**I . Overall dimensions and main parameters**

**1.Overall dimensions of basic machine**

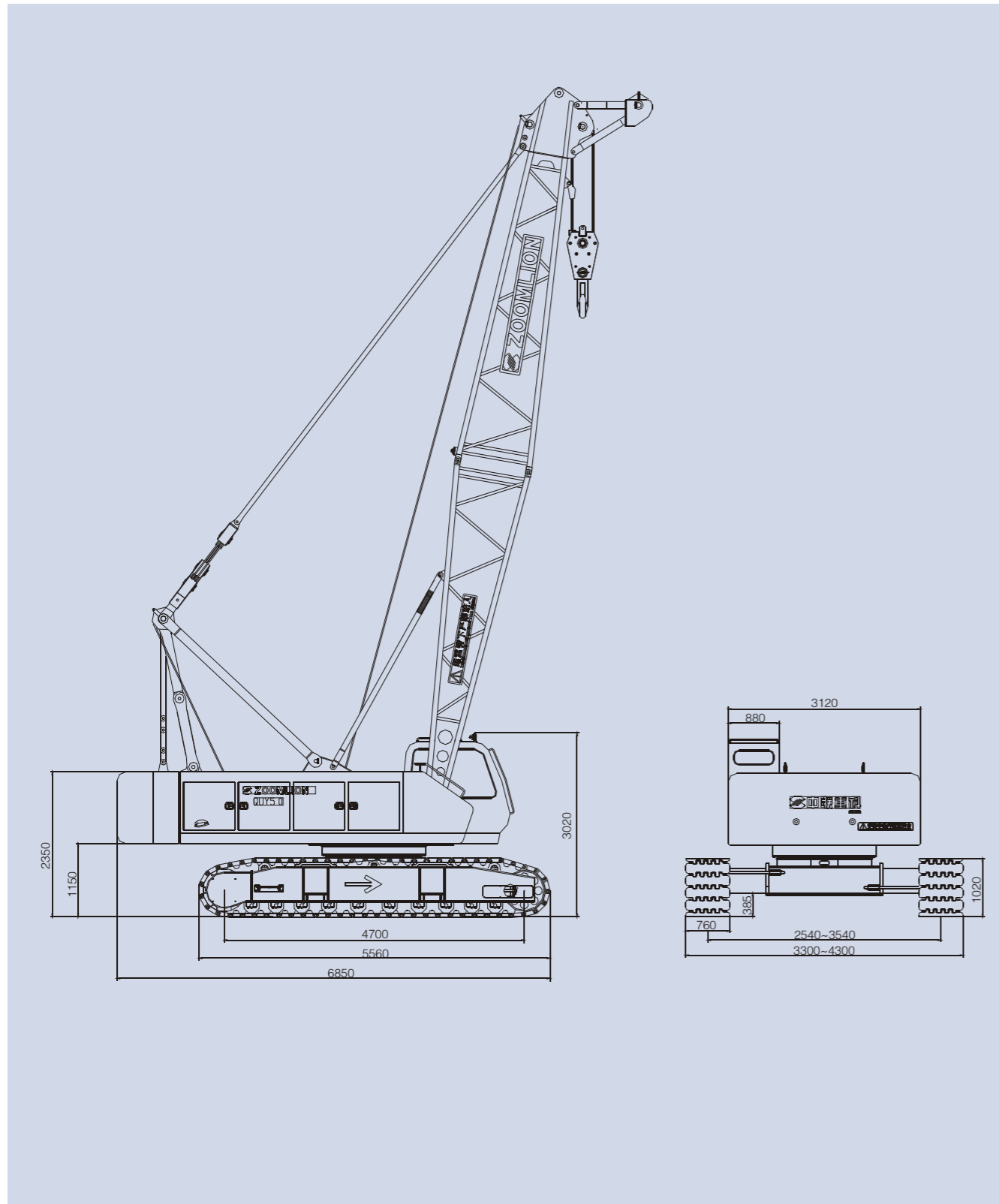

**2.Main technical parameters**

Item	Unit	Value	Remarks	
Max. lifting capacity × radius	t × m	55 × 3.7		
Deadweight with basic boom	t	48		
Main boom length	m	13~52		
Fixed jib length	m	6~15		
Max. lifting capacity on fixed jib	t	5		
Fixed jib angle	°	10,30		
Max. length of main boom with fixed jib	m	43 + 15		
Single rope speed of winches	Hoisting winch 1	m/min	120	The 4 <sup>th</sup> rope layer
	Hoisting winch 2	m/min	120	The 4 <sup>th</sup> rope layer
	Derricking winch	m/min	60	The 4 <sup>th</sup> rope layer
Slewing speed	rpm	0~3.0		
Traveling speed	km/h	0~1.6		
Gradeability	%	40		
Ground pressure	MPa	0.066		
Overall dimensions (L × W × H)	mm	6850 × 3300 × 3020	Without boom frame	
Engine	USA Cummins		6BTA5.9-C180	
	Rated power/ rotational speed	kW/rpm	132/2200	
	Max. output torque/ rotational speed	Nm/rpm	750/1300	
	Exhaust emission		According to U.S.EPA Tier2 and EU Stage II	
	Weichai		WP6.210	
	Rated power/ rotational speed	kW/rpm	155/2300	
Engine	Max. output torque/ rotational speed	Nm/rpm	807/1300--1500	
	Exhaust emission		According EU Stage III	
Distance between track center × crawler contact length × crawler width		mm	2540 × 4700 × 760	Crawler carrier retracted
Distance between track center × crawler contact length × crawler width		mm	3540 × 4700 × 760	Crawler carrier extended

3. Transport dimensions and weights of main components

Unit: mm

Transport weight of basic machine: 30t Number: 1 Width: 3300mm

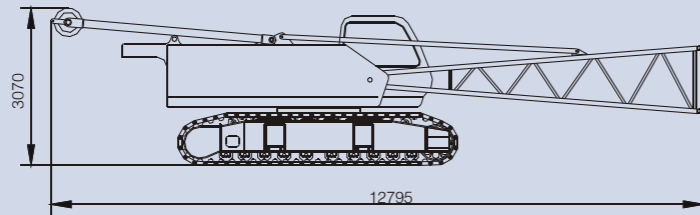

Counterweight plate: 8t Number: 1 Height: 1205mm

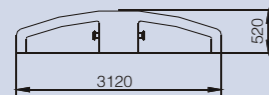

Counterweight plate: 8t Number: 1 Height: 1205mm

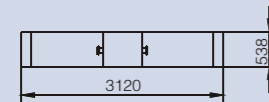

Load hook (50T): 0.6t Number: 1

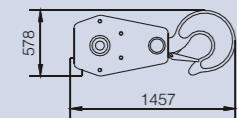

Load hook (16T): 0.3t Number: 1

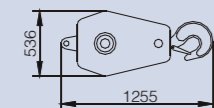

Load hook (6T): 0.18t Number: 1

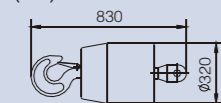

Main boom head: 0.73t Number: 1 Width: 1450mm

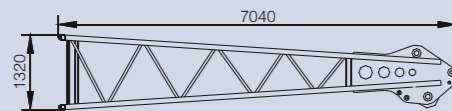

3m main boom intermediate section: 0.21t Number: 1 Width: 1450mm

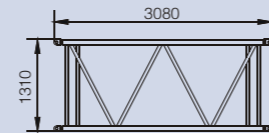

6m main boom intermediate section: 0.38t Number: 3 Width: 1450mm

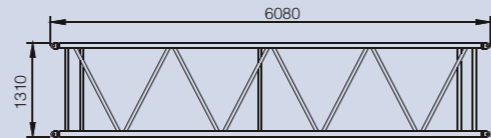

9m main boom intermediate section: 0.55t Number: 2 Width: 1450mm

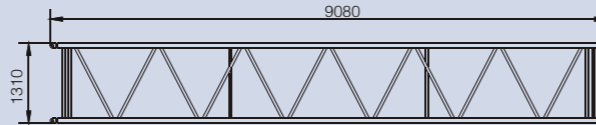

Fixed jib pivot section (with FA-frame and tilting-back support of fixed jib): 0.47t Number: 1 Width: 560mm

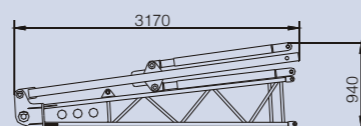

3m fixed jib intermediate section: 0.061t Number: 3 Width: 560mm

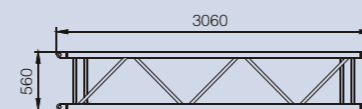

Fixed jib head: 0.25t Number: 1 Width: 560mm

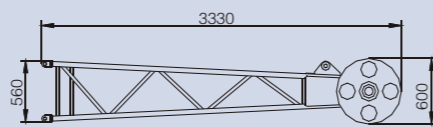

II . Technical instruction

4. Boom system

The lattice boom is made of high-strength steel pipes.

Main boom (S boom)

S- main boom: 13 ~ 52m

Main boom intermediate section: 3m, 6m and 9m

Main boom with fixed jib (SF boom)

F- fixed jib: 6 ~ 15m

Fixed jib intermediate section: 3m

Max. length of main boom with fixed jib: 43 + 15m

S- main boom: 25m-43m

Number of main boom intermediate section for S boom

Main boom length (m)	Number of main boom intermediate section		
	3m	6m	9m
16	1	0	0
19	2	0	0
22	1	1	0
25	2	1	0
28	1	2	0
31	1	1	1
34	2	1	1
37	1	2	1
40	1	1	2
43	2	1	2
46	1	2	2
49	1	1	3
52	1	3	2

Note: An optional number of main boom intermediate sections with 3m, 6m and 9m lengths are available for S boom depending on main boom length. It is subjected to the contract signed with customers.

5. Working mechanism

Hoisting winch 1

The hoisting winch 1 is composed of concealed axial piston hydraulic motor, balance valve, reducer, normally closed brake as well as wire rope. It is controllable independently.

The free-fall function, available for hoisting winch 1, is optional depending on customers' demands.

The hoisting winch 1 has two kinds of hoisting speed, which can improve the working efficiency dramatically.

Hoisting winch 1	Rope diameter	20mm
	Rope length	200m
	Single rope speed (on the 4 <sup>th</sup> rope layer)	0 ~ 120m/min
	Single rope force	65kN

Hoisting winch 2

The hoisting winch 2 is composed of concealed axial piston hydraulic motor, balance valve, reducer, normally closed brake as well as wire rope. And it is controllable independently.

The hoisting winch 2 has two kinds of hoisting speed, which can improve the working efficiency dramatically.

Hoisting winch 2	Rope diameter	20mm
	Rope length	130m
	Single rope speed (on the 4 <sup>th</sup> rope layer)	0 ~ 120m/min
	Single rope force	65kN

Derricking winch

The derricking winch is composed of concealed axial piston hydraulic motor, balance valve, reducer and normally closed brake, pulley block as well as wire rope. And it is controllable independently.

It is also equipped with a ratchet locking device to prevent the derricking winch from rotating during long time parking.

Derricking winch	Rope diameter	17mm
	Rope length	130m
	Single rope speed (on the 4 <sup>th</sup> rope layer)	0 ~ 60m/min
	Single rope force	45kN

### Slewing mechanism

The slewing mechanism consists of concealed axial piston hydraulic motor, gear reducer, slewing brake valve, brake and pinion gear as well as slewing ring. The superstructure can realize 360° continuous rotation via slewing ring which is driven by pinion gear.

The slewing mechanism of closed oil circuit system has controllable free swing function which can reduce the impacts on the crane and ensure that the slewing motion can be initiated/ stopped more stably.

The internal-gear slewing ring and slewing reducer built in the crane, are of strong load-carrying capacity and high accuracy, which can ensure stable and accurate slewing motion.

Infinitely variable speed from 0 to 3 r/min

The slewing mechanism can be locked by two mechanical locking devices in the front of slewing table.

### Traveling mechanism

The traveling mechanism is fitted with two hydraulic motors and two traveling reducers. Using control levers, the traveling movements can be controlled, such as traveling straight ahead/backwards, turning with a crawler, differential steering, turning on spot, traveling with load. This kind of design enables crane to have high

Traveling speed: 0 ~ 1.6km/h

Gradeability: 40%

The tension degree of crawler can be adjusted by jack quickly and conveniently.

### A-frame mechanism

A-frame mechanism consists of A-frame, A-frame anchoring rods and anchoring rod for self-assembly/dismantling and so on. It is mainly used for assembly, dismantling and conversion of crane. After A-frame is tilted backwards, the counterweight anchoring rods can be connected to A-frame anchoring rods, thus A-frame can be used to attach and remove the counterweight.

The A-frame must be laid down on the rear part of slewing table during transport

### Counterweight

The counterweight is composed of two counterweight plates, counterweight mounting pins and counterweight fixing bolts.

For QUY50 crawler crane, the counterweight can be fitted and removed by crane itself.

### Crawler carrier extending/retracting mechanism

The crawler carrier, connected to undercarriage centre section via outrigger, can be extended and retracted by cylinder. The crawler carrier extending/retracting cylinder is located inside the crawler carrier. Its one end is connected to undercarriage centre section, and the other end is jointed to crawler carrier.

## 6. Crane system

### Hydraulic system

The hydraulic system is composed of main pump, control valve, hydraulic motor, hydraulic oil tank, and oil cooler and so on.

International advanced pump-control system is applied in the hydraulic system and main hydraulic elements have such advantages as high energy-saving, great reliability and long service life.

Main hydraulic pump, driven by engine

Slewing pump is imported

Auxiliary mechanism is supplied oil by gear pump

Main control valve: electro-hydraulic pilot valve

Main circuit control way: main pump + main changeover valve, controlled by two control levers.

Oil cooler: it is an aluminium cooler, and the cooler fan is driven by a motor.

The overflow valve fitted in hydraulic system can restrain the pressure in the oil circuit from rising irregularly, thus protect such hydraulic elements as hydraulic oil pump and hydraulic motor against damage and prevent the hydraulic system from being overloaded.

### Electrical system

24VDC, negative ground, two batteries of 165AH each

The electrical system of machine includes power source, engine start, engine shutdown, indicator light, warning device, illumination device, fan, wiper, horn, hoisting limiter, hydraulic oil cooling fan, digital display system, PLC controller, engine preheating device, safety equipment etc. which not only ensure safe operation of the crane, but also provide a good working environment. The crane adopts CAN bus control technology, which connects the engine, PLC controller and digital display efficiently, possessing fault detecting and self-diagnosis function.

### Crane engine

6-cylinder Dongfeng Cummins (Weichai) diesel engine, turbocharger, watercooled

Dongfeng Cummins engine - rated power/ rotational speed: 132kW / 2200 rpm

(Weichai engine - rated power/ rotational speed: 155kW / 2300rpm)

Dongfeng Cummins engine - max. output torque/ rotational speed: 750N.m / 1300 rpm

(Weichai engine - max. output torque/ rotational speed: 807N.m/ (1300-1500) rpm)

Fuel tank has a great capacity of 300L, which can ensure long time working of engine.

Exhaust emissions:

Dongfeng Cummins engine complies with U.S.EPA Tier2 and EU Stage II .

Weichai engine complies with EU StageIII

### Digital display system

The LCD, having Chinese and English language versions, can show various data collected by PLC controller such as engine speed, water temperature, engine oil pressure, pressure of hydraulic pump, pressure of main motor, crane inclination, and operating hours of engine and so on. In this way, it can monitor the working state of crane at any time. When abnormal conditions occur, the system will send out red or yellow warning signal.

## 7. Safety equipment

### Load moment limiter

It is composed of digital LCD, CPU, signal converter, sensor and so on. When actual load moment reaches 90% of the maximum permissible load moment, the warning light will light up and the buzzer will sound. When actual load moment approaches the maximum permissible load moment, all dangerous movements will be switched off automatically so as to avoid accidents caused by overloading of crane, and thus ensure normal and safe crane operation.

The following data can be shown on the digital LCD:

Moment ratio

Main boom angle

Main boom length

Working radius

Actual load

Maximum permissible lifting load

Maximum permissible lifting height

### Hoisting limiter

Device to prevent any specified upper limitation of the load lifting attachment from being exceeded.

If the load hook comes into contact with hoisting limit switch weight during its upward movement, the hoisting limit switch is triggered, the buzzer sounds, and the crane movement "spool up winch" is switched off.

### Angle indicator

It is fitted at the lower rear end of boom pivot section (i.e. on the right side of the operator's cab). The operator can clearly see the boom angle in the cab.

### Derricking limiter

Device, constituted by load moment limiter and limit switch, to prevent derricking motions of main boom beyond specified limits

### Tilting back support for main boom

The spring-loaded tilting-back steel support, mounted on the main boom pivot section, is used to prevent the main boom from tilting backwards.

### Crane inclinometer

An electronic inclinometer to indicate the "leveled position" of the crane

### Safety catch

Device to protect the lifted load from jumping out from the hook

### Ratchet locking device for derricking winch

Device to prevent the derricking winch from rotating during long time parking

### Lowering limiter

Device to ensure that three windings of rope on the hoist drum are maintained at all times during operation

When there are only 3 windings of wire rope left on the drum, the lowering limit switch is triggered, the buzzer sounds, and the crane movement "reel off winch" is switched off.

### Anemometer

An electronic device to indicate the actual wind speed to the crane operator

### Emergency shut-down button

Allow all crane movements and electrical control system to be cut off quickly in a dangerous situation.

### Tricolor warning light

The warning light, by showing red, yellow and green three colors, can indicate loading status synchronously. The green color means the load ratio is less than 90%, the yellow color means the load ratio is between 90% and 100%, and the red color means that the load ratio has exceeded 100% and the crane is overloaded.

### Monitoring system (optional)

2 video cameras: respectively monitor the working condition of crane winches and rear side of the crane

Display: switch between the monitoring screens via press-key.

### Remote monitoring system GPS (optional)

Application of GPS enables such functions to be available as global positioning, GPRS data transmitting, working condition monitoring, remote fault diagnosing.

## 8. Operator's cab

Spacious, comfortable and all-steel construction cab, equipped with sun visor, adjustable seat, wiper, electric control levers, display of load moment limiter, digital display, switches on auxiliary control box, air conditioning, fan, lighting lamp, Radio (CD player or DVD player), cigarette lighter, fire extinguisher etc.

## 9. Load Hook

50t load hook: 5 pulleys

16t load hook(optional): 1 pulley

6t load hook: without pulley

### III. Self-assembly & dismantling function

Take the self-assembly of crane in SF boom configuration as an example

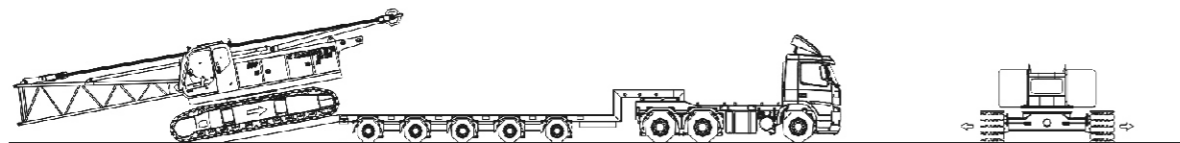
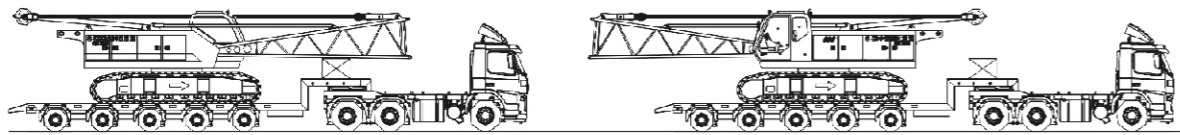

Unloading of basic machine

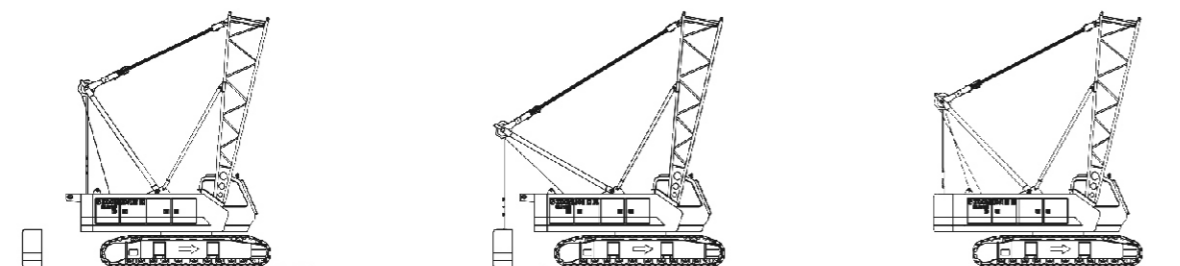
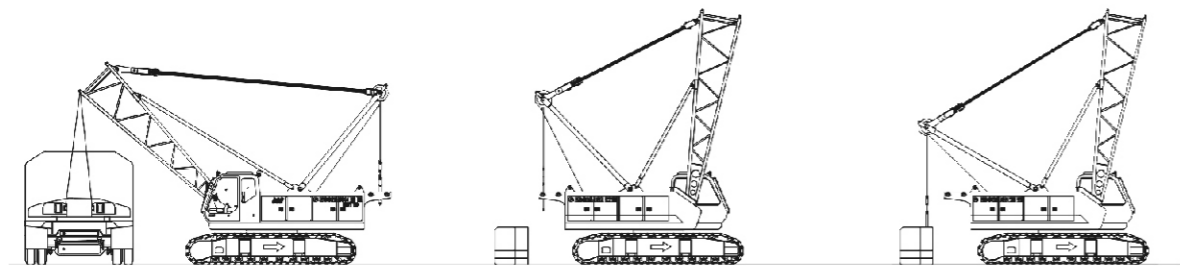

Unloading and assembly of counterweight

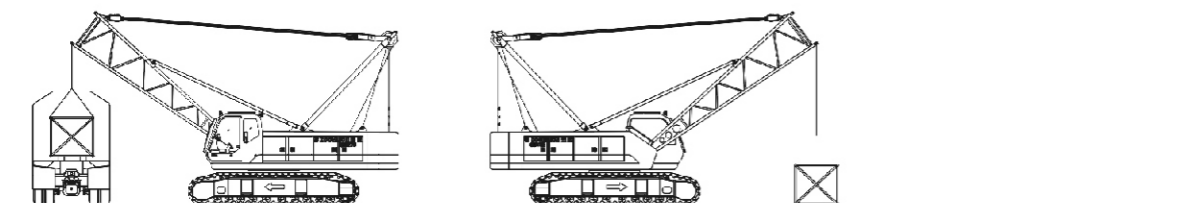

Unloading of boom frame

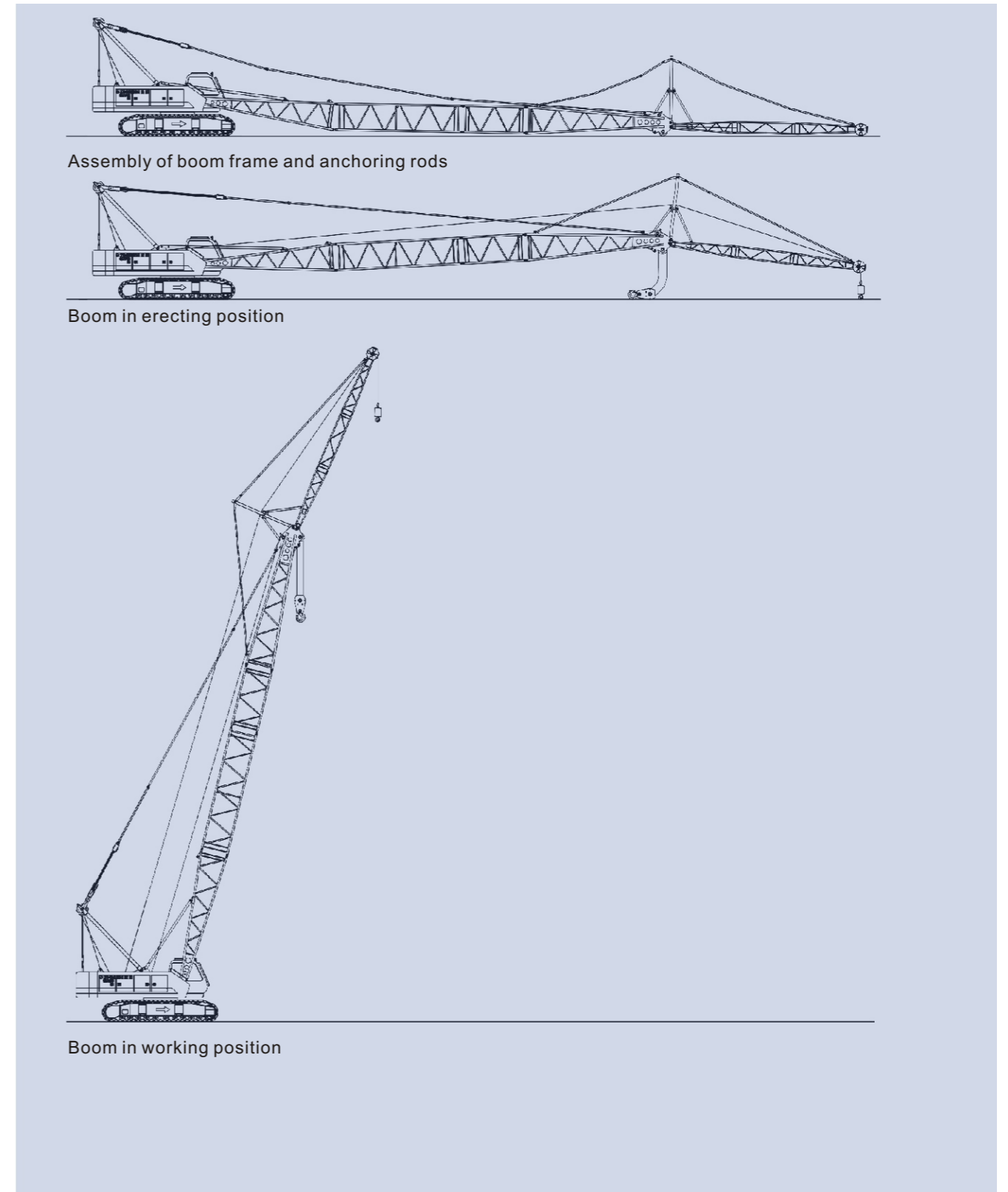

Assembly of boom frame and anchoring rods

Boom in erecting position

Boom in working position

**IV. Lifting capacity**

**10. Lifting performance on S boom**

Lifting height on S boom

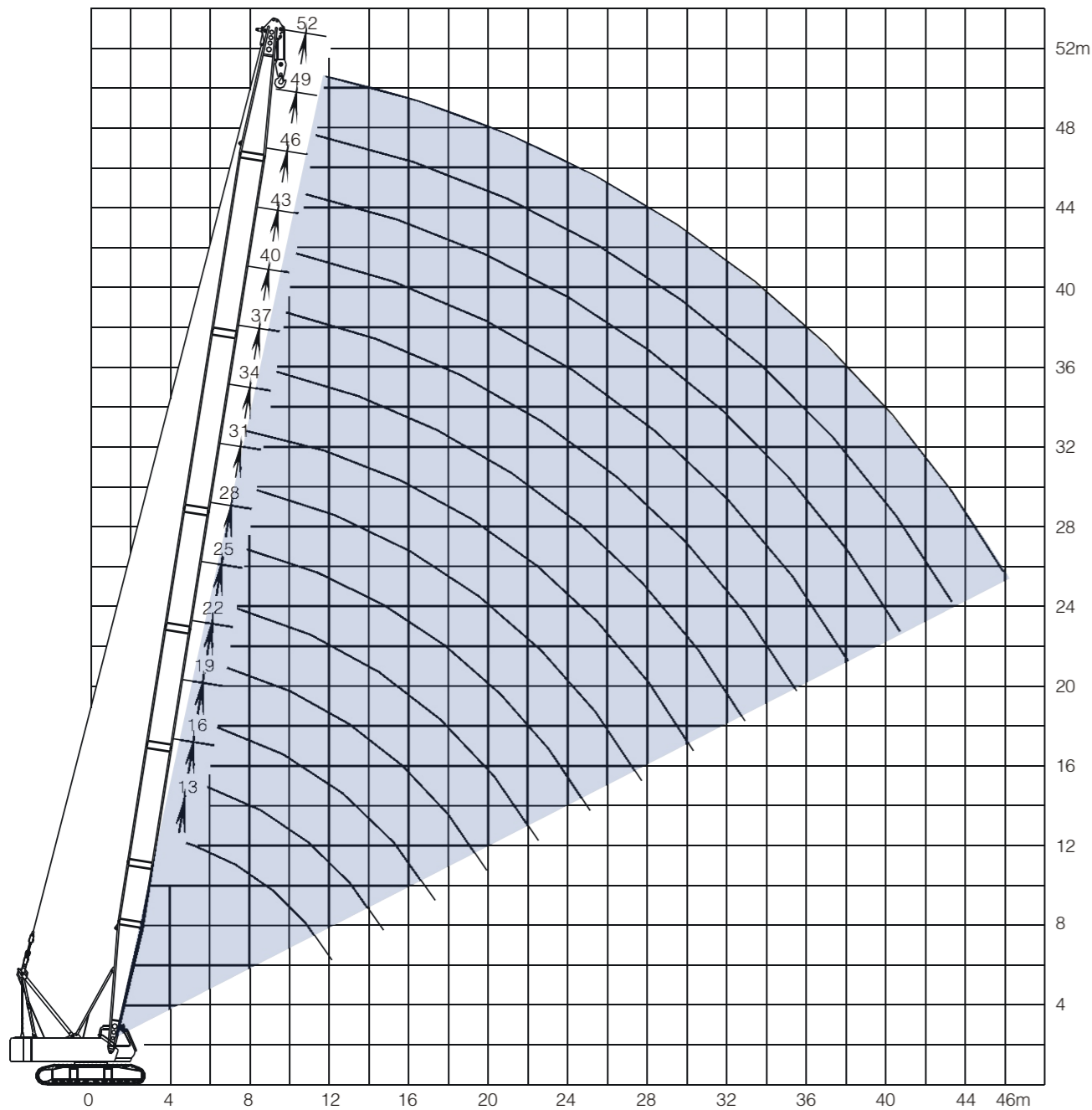

Lifting capacity on S boom

Length of S (m)	13	16	19	22	25	28	31	34	37	40	43	46	49	52
Reeving	10	10	8	6	5	5	5	3	3	3	3	2	2	2
Radius (m)	10	10	8	6	5	5	5	3	3	3	3	2	2	2
3.7	55													
4	49.5	47.3												
4.5	41	40.1	38.5											
5	34.3	34.2	33.7	32										
5.5	29.5	29.4	29.3	29.1	27.5									
6	25.8	25.8	25.6	25.5	25.4	24.2								
7	20.6	20.6	20.4	20.4	20.3	20.2	20							
8	17.1	17.5	16.8	16.8	16.8	16.6	16.6	16.4	16.2					
9	14.6	14.5	14.5	14.3	14.2	14.1	14.0	13.75	13.6	13.4	13.2			
10	12.7	12.55	12.5	12.3	12.3	12.2	12.1	12	11.8	11.5	11.3	11.1	11.0	10.3
12	10	9.8	9.8	9.6	9.5	9.58	9.45	9.2	9	8.8	8.7	8.5	8.4	8.3
14		8.1	8.1	8	7.8	7.7	7.6	7.4	7.2	7.0	6.85	6.7	6.6	6.5
16			6.8	6.5	6.4	6.35	6.3	6.1	5.9	5.7	5.6	5.5	5.4	5.2
18				5.7	5.5	5.35	5.3	5.1	4.9	4.7	4.6	4.4	4.3	4.2
20				4.9	4.6	4.6	4.5	4.3	4.2	4	3.9	3.7	3.6	3.5
22					4.0	4.0	3.9	3.7	3.6	3.4	3.3	3.1	3	2.85
24						3.5	3.4	3.2	3.1	2.9	2.8	2.6	2.5	2.4
26							2.9	2.8	2.6	2.45	2.3	2.15	1.9	1.9
28								2.4	2.3	2.1	2	1.8	1.7	1.6
30									2.1	1.95	1.8	1.7	1.5	1.3
32										1.68	1.5	1.4	1.25	1
34											1.3	1.2	1.1	0.8

Note:

1. The lifting capacity given in the above chart contains the weight of load hook and weight of wire rope between boom head and load hook.
2. When tip boom is used to lift the load, the lifting capacity on tip boom is the same as that on main boom of same length in the same working radius.

**11. Lifting performance on SF boom**

Lifting height on SF boom

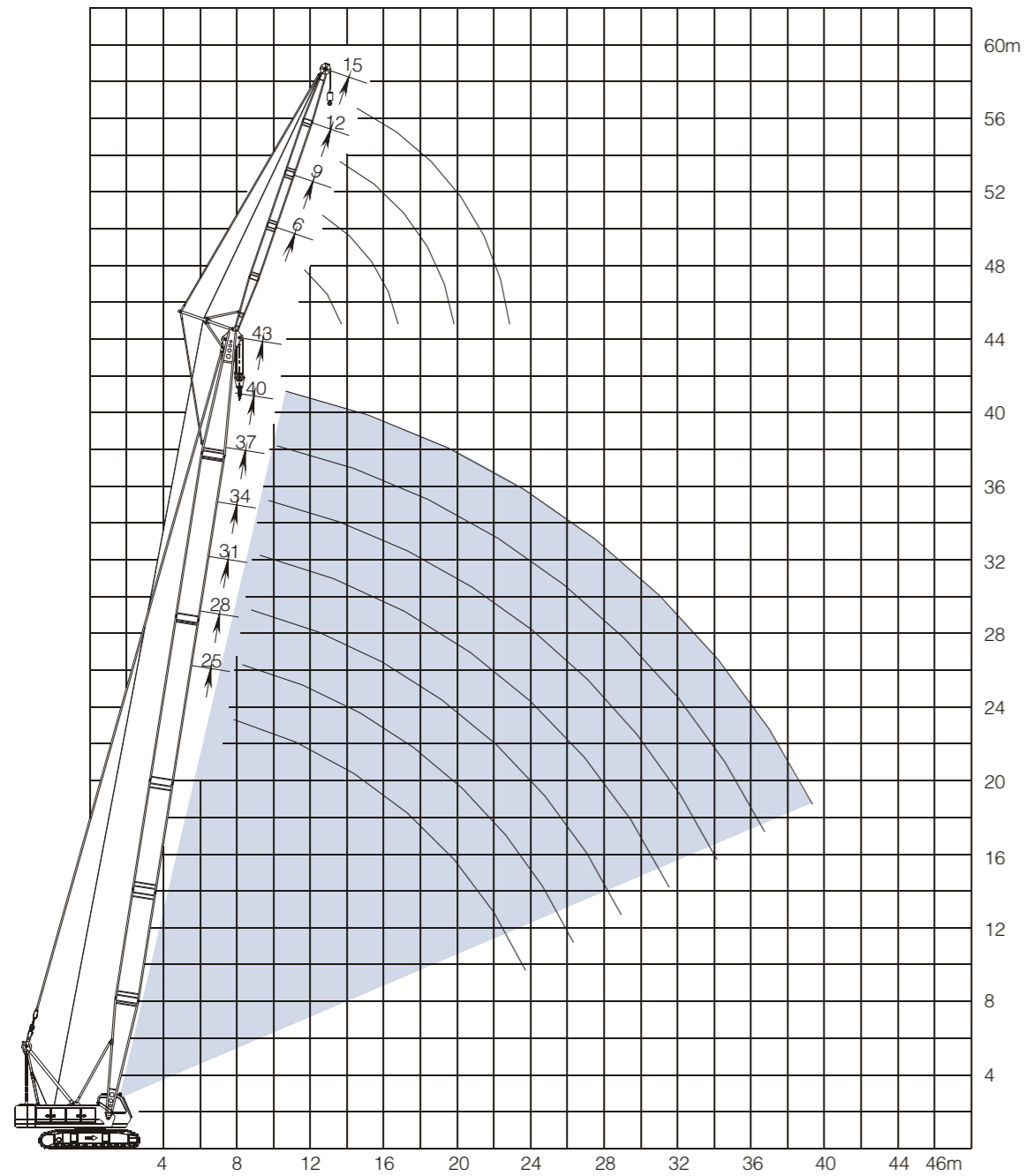

Lifting height on SF boom (F-jib angle= 10°)  
S-boom angle = 50°- 81°

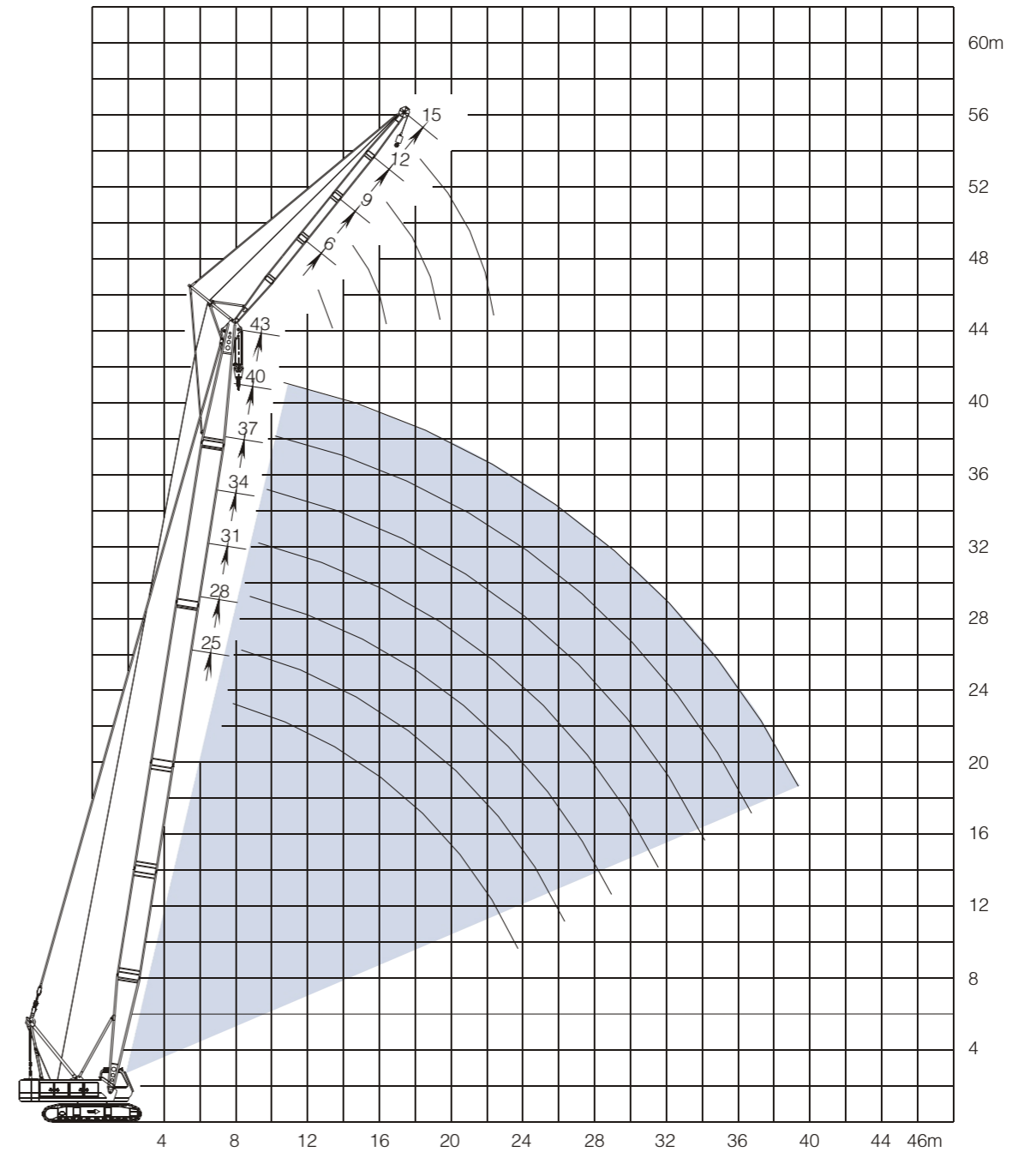

Lifting height on SF boom (F-jib angle= 30°)  
S-boom angle = 50°- 81°



Lifting capacity on SF boom

Length of S (m) Length of F (m) Jib angle (°) Radius(m)	25								28								
	6		9		12		15		6		9		12		15		
	10°	30°	10°	30°	10°	30°	10°	30°	10°	30°	10°	30°	10°	30°	10°	30°	
8																	
10	5																
12	5	5	5	4.7	4		3.3		5	5	5	4.6	4				
14	5	5	5	4.5	4	3.7	3.2		5	5	5	4.5	4	3.6	3.2		
16	5	5	5	4.2	4	3.5	3.2	3	5	5	5	4.3	4	3.6	3.2		
18	5	4.8	5	3.9	3.9	3.4	3.2	3	5	4.8	5	4	3.9	3.5	3.2	3	
20	4.8	4.5	4.9	3.8	3.8	3.2	3.1	2.8	4.7	4.7	4.8	3.9	3.8	3.3	3.1	2.9	
22	4.2	4.2	4.2	3.6	3.7	3.1	3	2.7	4.1	4.1	4.1	3.7	3.7	3.2	3	2.7	
24	3.7	3.7	3.7	3.4	3.5	3	2.9	2.5	3.5	3.6	3.6	3.5	3.5	3	3	2.6	
26	3.2	3.3	3.3	3.3	3	2.8	2.8	2.4	3.1	3.1	3.2	3.2	3.2	2.9	2.8	2.5	
28	2.9	2.9	2.9	3	2.7	2.7	2.7	2.3	2.8	2.8	2.8	2.9	2.8	2.8	2.7	2.4	
30	2.5	2.5	2.6	2.6	2.5	2.5	2.6	2.2	2.4	2.5	2.5	2.5	2.5	2.6	2.6	2.3	
32			2.3	2.3	2.3	2.4	2.4	2.2	2.2	2.2	2.2	2.3	2.2	2.3	2.3	2.2	
34						2.1	2.1	2.1			2	2	2	2.1	2	2.1	

Length of S (m) Length of F (m) Jib angle (°) Radius(m)	31								34								
	6		9		12		15		6		9		12		15		
	10°	30°	10°	30°	10°	30°	10°	30°	10°	30°	10°	30°	10°	30°	10°	30°	
8																	
10																	
12	5	5	5		4				5		5						
14	5	5	5	4.7	4		3.2		5	5	5	4.6	4		3.2		
16	5	5	5	4.3	4	3.7	3.2		5	5	5	4.5	4	3.6	3.2		
18	5	5	5	4.1	3.9	3.5	3.2	3.1	5	5	5	4.3	3.9	3.5	3.2		
20	4.5	4.6	4.6	4	3.8	3.4	3.1	3	4.5	4.5	4.6	4.1	3.8	3.5	3.1	3	
22	4	4	4	3.8	3.7	3.2	3	2.8	3.8	4	3.9	3.8	3.7	3.4	3	2.9	
24	3.5	3.5	3.5	3.6	3.6	3.1	2.9	2.7	3.4	3.5	3.4	3.6	3.5	3.1	3	2.8	
26	3.1	3.1	3.1	3.2	3.1	3	2.8	2.6	2.9	3	3	3.1	3	2.9	2.8	2.7	
28	2.7	2.7	2.7	2.8	2.7	2.9	2.75	2.5	2.6	2.6	2.6	2.7	2.7	2.8	2.7	2.6	
30	2.3	2.4	2.4	2.5	2.4	2.5	2.5	2.4	2.2	2.3	2.3	2.4	2.3	2.5	2.4	2.5	
32	2.1	2.1	2.1	2.1	2.1	2.2	2.2	2.3	2	2	2	2.1	2.1	2.2	2.1	2.2	
34	1.8	1.8	1.9	1.9	1.9	2	1.9	2.1	1.7	1.8	1.8	1.8	1.8	1.9	1.8	2	

Lifting capacity on SF boom

Length of S (m) Length of F (m) F-jib angle (°) Radius(m)	37								40								
	6		9		12		15		6		9		12		15		
	10°	30°	10°	30°	10°	30°	10°	30°	10°	30°	10°	30°	10°	30°	10°	30°	
8																	
10																	
12	5								5								
14	5	5	5		4				5	5	5						
16	5	5	5	4.5	4		3.2		5	5	5	4.6	4		3.3		
18	5	5	5	4.4	3.9	3.6	3.2		5	5	5	4.3	3.9	3.7	3.2		
20	4.4	4.5	4.5	4.2	3.8	3.5	3.1	3	4.3	4.4	4.3	4.2	3.8	3.5	3.1	3	
22	3.8	3.9	3.9	4	3.7	3.3	3	2.9	3.7	3.8	3.7	3.9	3.7	3.4	3	2.9	
24	3.3	3.4	3.3	3.5	3.4	3.2	2.9	2.8	3.2	3.3	3.2	3.4	3.3	3.2	2.9	2.8	
26	2.8	2.9	2.9	3	2.9	3.1	2.8	2.7	2.7	2.8	2.8	3	2.8	3.1	2.8	2.7	
28	2.5	2.5	2.5	2.6	2.6	2.7	2.6	2.6	2.4	2.5	2.4	2.6	2.5	2.7	2.5	2.6	
30	2.1	2.2	2.2	2.3	2.2	2.4	2.3	2.5	2	2.1	2.1	2.2	2.1	2.3	2.2	2.4	
32	1.9	1.9	1.9	2	2	2.1	2	2.2	1.8	1.8	1.8	1.9	1.9	2	1.9	2.1	
34	1.6	1.7	1.7	1.8	1.7	1.8	1.7	1.9	1.5	1.6	1.6	1.7	1.6	1.7	1.6	1.8	

Length of S (m) Length of F (m) F-jib angle (°) Radius(m)	43							
	6		9		12		15	
	10°	30°	10°	30°	10°	30°	10°	30°
12								
14	5				5			
16	5	5			5		4	
18	4.8	5			4.7	4.5	3.9	
20	4.1	4.3			4.2	4.3	3.8	
22	3.5	3.7			3.6	4	3.6	
24	3.1	3.2			3.1	3.3	3.1	
26	2.6	2.8			2.7	2.9	2.7	
28	2.3	2.4			2.3	2.5	2.4	
30	1.9	2			2	2.1	2	
32	1.7	1.7			1.7	1.8	1.8	
34	1.4	1.5			1.5	1.6	1.5	