

[SPECIFICATION]

■ CRANE

Description Rough terrain crane with maximum lifting capacity 20 ton

● Crane specification

Maximum rated lifting capacity	6.5 m Boom	20,000kg × 2.5 m (Parts of line : 7)
	10.95 m Boom	12,500kg × 4.0 m (Parts of line : 6)
	15.4 m Boom	10,000kg × 5.0 m (Parts of line : 4)
	19.6 m Boom	7,500kg × 6.0 m (Parts of line : 4)
	23.8 m Boom	6,000kg × 6.0 m (Parts of line : 4)
	28.0 m Boom	5,000kg × 6.5 m (Parts of line : 4)
	4.0 m Jib	2,500kg × 75° (Parts of line : 1)
Maximum rated lifting height	5.8 m Jib	2,000kg × 75° (Parts of line : 1)
	Rooster	3,200kg (Parts of line : 1)
Boom length	6.5m — 28.0m	
Jib length	4.0m — 5.8m	
Maximum rated lifting height	29.1m (Boom)	
	34.8m (jib)	
Hoisting line speed (winch up)	Main winch	95m / min. (at 5th layer)
	Auxiliary winch	84m / min. (at 3rd layer)
Hoisting hook speed (winch up)	Main winch	(Parts of line; 7) : 13.5m / min. (at 5th layer)
	Auxiliary winch	(Parts of line; 1) : 84.0m / min. (at 3rd layer)
High-speed lowering Rope speed	Main winch	133m / min (at 3th layer)
	Auxiliary winch	133m / min (at 3rd layer)
Boom derricking angle	-9.5° — 83°	
Boom derricking time	40s / -9.5° — 83°	
Boom extending speed	21.5m / 75s	
Slewing speed	2.9min ⁻¹	
Tail slewing radius	2,390mm (Slide sheave)	
	2,250mm (Rear cover)	

● Equipment and structure

Boom type	Round-shaped, 6-section hydraulically telescopic type (the 2nd and 3rd boom sections at the same time, the 4th, 5th and 6th boom sections at the same time)	
Jib type	2 sections (2nd section of draw-out type) Hydraulic stepless tilting type (offset angles 7° — 60°)	
Boom extension/retraction equipment	Two hydraulic cylinders and wire ropes used together	
Boom derricking/lowering equipment	One hydraulic cylinder of direct acting type with pressure-compensated flow control valve	
Jib derricking/lowering equipment	Hydraulic cylinder	
Winch system Main & Auxiliary winches	Two units of Single winch, Planetary gear reduction type (built-in negative brake) with Automatic brake, High/Low speed switching system and Hydraulic compensated flow control valve.	
Slewing equipment	Equipped with Hydraulic motor drive and a planetary gear speed reducer (built-in negative brake), Free / Lock change-over type	
Slewing bearing	Ball bearing type	
Outriggers	Type	Hydraulic H-beam type (with float and vertical cylinder in single unit) 5,400mm (Fully extended)
	Extension width	4,800mm (Intermediately extended)
		4,300mm (Intermediately extended)
		3,200mm (Intermediately extended)
		1,930mm (Completely retracted)
Wire rope for hoisting	Main winch	Diameter: 14mm × Length: 155m
	Auxiliary winch	Diameter: 14mm × Length: 76m

● Hydraulic equipment

Oil pump	4 pumps, plunger and gear type	
Hydraulic motor	Hoisting motor	Axial plunger type
	Slewing motor	Axial plunger type
Control valve	Double acting with integral check and relief valves (With Hydraulic compensated flow control valve)	
Cylinder	Double acting type	
Oil reservoir capacity	280L	

● Safety devices

ACS (Automatic Crane System with Voice alarm), Slewing automatic stop system, Working range limit mode, Outrigger status detector, Boom derricking / telescoping holding valve, Jib derricking holding valve, Overhoist prevention device, Winch holding valve, Automatic winch brake, Winch drum roller, Hydraulic safety valves, Outrigger lock pins, Slewing warning lamp, Hydraulic oil temperature warning device, Hydraulic oil return filter warning device

● Standard equipment

Air conditioner, Working light (on boom, table and cab), Winch drum turning indication device, Hook for 20 ton, Hook for 3.2 ton

● Operator's cab

Adjustable steering wheel, Adjustable seat, Power Window(external closing switch), Front windscreen wiper & washer (2 speed wiper), Roof window wiper & washer, AM/FM Radio, Step lamp, Floor mat, Accessory socket (24V), Emergency set

● Optional equipment

ACS outside indicator, PA system, Winch view camera, Door visor, Fire extinguisher

■ CARRIER

● Carrier specification

Maximum traveling speed	49km/h
Grade ability	60% (computed at G.V.W. = 19,715 kg)
Minimum turning radius (center of extreme outer tire)	8.0m (2 wheel steer)
	4.7m (4 wheel steer)

● Engine

Model	Cummins QSB6.7-4A (Tier4 Interim / Stage IIIB)
Type	4 cycle, 6 cylinders, water cooled, direct injection turbo-charged diesel engine with intercooling
Piston displacement	6.690L
Max. power	175kW at 2,300min ⁻¹
Max. torque	888N·m at 1,500min ⁻¹

Diesel Fuel recommended by KATO must be used

● Equipment and structure

Drive system	Switches between 2 wheel drive (4 × 2) and 4 wheel drive (4 × 4)	
Torque converter	Engine mounted 3 elements 1 stage (with lock up clutch)	
Transmission	Remote mounted full automatic	
Number of speeds	4 forward & 1 reverse speed	
Axles	Front	Planetary, drive/steer type
	Rear	Planetary, drive/steer type
Suspension	Front	Taper-leaf spring, Hydraulic locking device with suspension cylinder
	Rear	Taper-leaf spring, Hydraulic locking device with suspension cylinder
Brake system	Service	Air-over hydraulic disk brake on 4 wheels (front and rear independent circuit)
	Parking	Spring applied, electrically air released parking brake mounted on front axle, internal expanding type
	Auxiliary	Exhaust brake, Service brake lock
Steering	Full hydraulic power steering, Completely independent front and rear steering (with automatic rear wheel steering lock system)	
Tire size	Front	325 / 95 R24 161E ROAD
	Rear	325 / 95 R24 161E ROAD
Fuel tank capacity	250 L	
Batteries	(12V-120Ah) × 2	

● Safety devices

Emergency steering device, Rear wheel steering lock system (automatic), Brake fluid leak warning device, Service brake lock, Suspension lock, Engine overspeed alarm, Electrically retractable side view mirrors, Left front view camera, Radiator coolant level warning device, Air filter service warning device, Low air warning device

● Standard equipment

Hydraulic oil cooler, Centralized lubricating system, Aluminum outrigger plate, Discharge head lamp

● Optional equipment

Wheel stopper, Way side lamp, Side marker lamp, Rear view camera, Storage box, Electrically retractable side view mirrors with defroster

■ GENERAL Dimensions

Overall length	8,710mm	
Overall width	2,290mm	
Overall height	3,210mm	
Wheel base	3,250mm	
Treads	Front	1,920mm
	Rear	1,920mm
Passenger capacity	One person	
Gross vehicle weight	Gross weight	approx. 19,715kg
	Front weight	approx. 9,875kg
	Rear weight	approx. 9,840kg

● Stow the hooks in place before traveling.



● Before you use this machine, read the precautions in the instruction manual thoroughly to operate it correctly.

● KATO products and specifications are subject to improvements and changes without notice.

RATED LIFTING CAPACITY

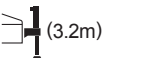
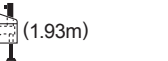

Based on ISO 4305
Not exceed 75% of static tipping loads

6.5m — 28.0m Boom

Working radius (m)	 (5.4m)						 (4.8m)						 (4.3m)						 (3.2m)						 (1.93m)						
	Outriggers fully extended (5.4m) - 360° full range						Outriggers intermediately extended (4.8m) - over side						Outriggers intermediately extended (4.3m) - over side						Outriggers intermediately extended (3.2m) - over side						Outriggers completely retracted (1.93m) - over side (H-type outrigger only)						
	6.5m Boom	10.95m Boom	15.4m Boom	19.6m Boom	23.8m Boom	28.0m Boom	6.5m Boom	10.95m Boom	15.4m Boom	19.6m Boom	23.8m Boom	28.0m Boom	6.5m Boom	10.95m Boom	15.4m Boom	19.6m Boom	23.8m Boom	28.0m Boom	6.5m Boom	10.95m Boom	15.4m Boom	19.6m Boom	23.8m Boom	28.0m Boom	6.5m Boom	10.95m Boom	15.4m Boom	19.6m Boom	23.8m Boom	28.0m Boom	
2.5	20.00*	12.50	10.00	7.50		20.00*	12.50	10.00	7.50			20.00*	12.50	10.00	7.50			17.70	12.50	10.00	7.50			8.15	7.95	7.90	7.50				
3.0	18.50*	12.50	10.00	7.50		18.00*	12.50	10.00	7.50			17.45	12.50	10.00	7.50			15.20	12.50	10.00	7.50			5.80	5.65	5.60	6.00				
3.5	16.20	12.50	10.00	7.50	6.00	5.00	16.00	12.50	10.00	7.50	6.00	5.00	15.00	12.50	10.00	7.50	6.00	5.00	10.40	10.20	10.00	7.50	6.00	5.00	4.35	4.20	4.15	4.55	4.75	4.95	
4.0	14.00	12.50	10.00	7.50	6.00	5.00	14.00	12.50	10.00	7.50	6.00	5.00	13.00	12.50	10.00	7.50	6.00	5.00	7.95	7.75	7.70	7.50	6.00	5.00	3.40	3.25	3.20	3.55	3.75	3.90	
4.5	12.00	12.00	10.00	7.50	6.00	5.00	12.00	12.00	10.00	7.50	6.00	5.00	11.15	12.00	10.00	7.50	6.00	5.00	6.30	6.15	6.10	6.50	6.00	5.00	2.70	2.55	2.50	2.85	3.05	3.20	
5.0		11.05	10.00	7.50	6.00	5.00		10.90	10.00	7.50	6.00	5.00		8.75	8.70	7.50	6.00	5.00		5.00	4.95	5.30	5.55	5.00		2.00	2.00	2.30	2.50	2.65	
5.5		10.20	9.30	7.50	6.00	5.00		8.85	8.80	7.50	6.00	5.00		7.20	7.15	7.50	6.00	5.00		4.10	4.05	4.45	4.65	4.85		1.60	1.55	1.85	2.05	2.20	
6.0		9.30	8.55	7.50	6.00	5.00		7.40	7.35	7.50	6.00	5.00		6.05	6.00	6.40	6.00	5.00		3.45	3.40	3.75	3.95	4.15		1.25	1.20	1.55	1.70	1.85	
6.5		7.85	7.80	7.10	5.75	5.00		6.30	6.25	6.65	5.75	5.00		5.15	5.10	5.45	5.70	5.00		2.95	2.90	3.20	3.40	3.55		0.95	0.90	1.25	1.45	1.55	
7.0		6.75	6.70	6.55	5.40	4.65		5.40	5.35	5.75	5.40	4.65		4.45	4.35	4.75	4.95	4.65		2.50	2.45	2.75	2.95	3.10		0.70	0.70	1.00	1.20	1.30	
8.0		5.15	5.10	5.45	4.75	4.05		4.15	4.05	4.45	4.65	4.05		3.35	3.30	3.65	3.85	4.00		1.80	1.75	2.10	2.30	2.40							
9.0		4.05	4.00	4.35	4.25	3.60		3.25	3.15	3.50	3.75	3.60		2.60	2.50	2.90	3.10	3.25		1.30	1.20	1.55	1.75	1.90							
10.0			3.20	3.55	3.75	3.20			2.45	2.85	3.05	3.20			1.90	2.30	2.50	2.65			0.80	1.15	1.35	1.50							
11.0			2.55	2.90	3.10	2.90			1.95	2.30	2.50	2.65			1.45	1.80	2.00	2.15			0.50	0.80	1.00	1.15							
12.0			2.05	2.40	2.60	2.65			1.50	1.85	2.05	2.20			1.10	1.45	1.65	1.80				0.55	0.75	0.90							
13.0			1.65	2.00	2.20	2.35			1.15	1.50	1.70	1.85			0.80	1.10	1.30	1.45				0.35	0.55	0.70							
14.0			1.45(13.5m)	1.65	1.85	2.00			1.00(13.5m)	1.20	1.40	1.55			0.65(13.5m)	0.85	1.05	1.20					0.35	0.50							
15.0				1.35	1.55	1.70				0.95	1.15	1.30				0.65	0.85	1.00						0.35							
16.0				1.10	1.30	1.45				0.75	0.95	1.10				0.45	0.65	0.80													
17.0				0.90	1.10	1.25				0.60	0.75	0.90				0.30	0.50	0.65													
18.0				0.80(17.5m)	0.90	1.05				0.50(17.5m)	0.60	0.75					0.35	0.50													
19.0					0.75	0.90					0.45	0.60																			
20.0					0.60	0.75					0.35	0.50																			
21.0					0.50	0.60						0.35																			
22.0					0.45(21.5m)	0.50																									
23.0						0.40																									
24.5						0.30																									
Critical boom angle	—	—	—	—	—	18°	—	—	—	—	22°	35°	—	—	—	12°	33°	42°	—	—	—	33°	41°	50°	56°	—	36°	59°	64°	69°	72°
Standard hook	for 20 ton						for 20 ton						for 20 ton						for 20 ton						for 20 ton						
Hook mass	150kg						150kg						150kg						150kg						150kg						
Parts of line	7*,6	6			4		7*,6	6			4		7*,6	6			4		6			4		6			4				



(Unit: Metric ton)

When outriggers are not used

Working radius (m)	 Stationary on rubber								 Pick & carry (less than 2km/h)								Working radius (m)
	6.5m Boom		10.95m Boom		15.4m Boom		19.6m Boom		6.5m Boom		10.95m Boom		15.4m Boom		19.6m Boom		
	Over front	360° full range	Over front	360° full range	Over front	360° full range	Over front	360° full range	Over front	360° full range	Over front	360° full range	Over front	360° full range	Over front	360° full range	
3.0	6.00	4.00	6.00	4.00	5.00	4.00	5.00	4.00	4.30	2.80	4.30	2.80	4.10	2.80	4.10	2.80	3.0
3.5	6.00	3.50	6.00	3.50	5.00	3.50	5.00	3.50	4.30	2.30	4.30	2.20	4.10	2.20	4.10	2.30	3.5
4.0	6.00	2.80	6.00	2.80	5.00	2.80	5.00	3.00	4.30	1.90	4.30	1.70	4.10	1.70	4.10	1.90	4.0
4.5	5.50	2.20	5.50	2.20	5.00	2.20	5.00	2.50	3.80	1.50	3.80	1.40	3.70	1.40	3.75	1.60	4.5
5.0			5.00	1.80	4.50	1.70	4.50	2.00			3.30	1.10	3.30	1.10	3.30	1.30	5.0
5.5			4.50	1.40	4.00	1.35	4.00	1.65			2.90	0.85	2.90	0.70	3.00	1.05	5.5
6.0			3.90	1.10	3.60	1.05	3.60	1.35			2.60	0.45	2.60	0.35	2.75	0.75	6.0
6.5			3.35	0.85	3.20	0.75	3.25	1.10			2.30		2.30		2.50	0.50	6.5
7.0			2.90	0.55	2.80		3.10				2.00		2.00		2.30		7.0
8.0			2.20		2.10		2.40				1.30		1.35		1.80		8.0
9.0					1.60		1.85						0.80		1.40		9.0
10.0					1.20		1.45						0.35		0.95		10.0
11.0					0.85		1.15								0.50		11.0
12.0					0.55		0.85										12.0
13.0							0.60										13.0
14.0							0.40										14.0
Critical boom angle	—	—	25°	37°	25°	60°	36°	66°	—	—	25°	46°	40°	61°	50°	66°	Critical boom angle
Standard hook	For 20 ton								For 20 ton								Standard hook
Hook mass	150kg								150kg								Hook mass
Parts of line	4								4								Parts of line

(Unit: Metric ton)



19.6m Boom + 4.0m Jib

 (5.4m)								 (4.8m)								 (4.3m)																															
Outriggers fully extended (5.4m) - 360° full range																Outriggers intermediately extended (4.8m) - over side																Outriggers intermediately extended (4.3m) - over side															
Boom angle (°)	Offset 7°		Offset 25°		Offset 45°		Offset 60°		Boom angle (°)	Offset 7°		Offset 25°		Offset 45°		Offset 60°		Boom angle (°)	Offset 7°		Offset 25°		Offset 45°		Offset 60°																						
	Working radius (m)	Load (ton)	Working radius (m)	Load (ton)	Working radius (m)	Load (ton)	Working radius (m)	Load (ton)		Working radius (m)	Load (ton)	Working radius (m)	Load (ton)	Working radius (m)	Load (ton)	Working radius (m)	Load (ton)		Working radius (m)	Load (ton)	Working radius (m)	Load (ton)	Working radius (m)	Load (ton)	Working radius (m)	Load (ton)																					
83	2.7	2.50	3.9	2.00	4.9	1.50	5.4	1.20	83	2.7	2.50	3.9	2.00	4.9	1.50	5.4	1.20	83	2.7	2.50	3.9	2.00	4.9	1.50	5.4	1.20																					
80	3.9	2.50	5.1	2.00	6.0	1.50	6.5	1.20	80	3.9	2.50	5.1	2.00	6.0	1.50	6.5	1.20	80	3.9	2.50	5.1	2.00	6.0	1.50	6.5	1.20																					
75	6.0	2.50	7.1	2.00	7.9	1.50	8.3	1.20	75	6.0	2.50	7.1	2.00	7.9	1.50	8.3	1.20	75	6.0	2.50	7.1	2.00	7.9	1.50	8.3	1.20																					
70	8.0	2.50	9.0	2.00	9.7	1.50	10.0	1.20	70	8.0	2.50	9.0	2.00	9.7	1.50	10.0	1.20	70	8.0	2.50	9.0	2.00	9.7	1.50	10.0	1.20																					
65	9.9	2.50	10.8	2.00	11.3	1.50	11.6	1.20	65	9.9	2.50	10.8	2.00	11.3	1.50	11.6	1.20	65	9.9	2.50	10.8	2.00	11.3	1.50	11.6	1.20																					
62	11.0	2.50	11.8	2.00	12.4	1.50	12.6	1.20	62	11.0	2.50	11.8	2.00	12.4	1.50	12.6	1.20	62	11.7	1.78	12.5	1.64	13.0	1.50	13.2	1.20																					
60	11.7	2.50	12.5	1.95	13.0	1.50	13.2	1.20	60	11.7	2.23	12.5	1.90	13.0	1.50	13.2	1.20	60	13.3	1.26	13.9	1.21	14.4	1.15																							
57	12.8	2.30	13.4	1.90	13.8	1.50			57	12.8	1.80	13.4	1.72	13.8	1.50			57	14.7	0.91	15.4	0.85	15.7	0.84																							
55	13.4	2.07	14.1	1.85	14.4	1.50			55	13.3	1.63	14.1	1.45	14.4	1.43			55	16.1	0.63	16.7	0.60	17.1	0.55																							
50	14.9	1.58	15.5	1.51	15.8	1.48			50	14.8	1.21	15.4	1.16	15.8	1.11			50	17.3	0.43	17.8	0.41																									
45	16.2	1.25	16.8	1.19	17.1	1.15			45	16.1	0.92	16.7	0.87	17.1	0.82			45	18.5	0.26	18.9	0.25																									
40	17.4	1.00	17.8	0.98					40	17.3	0.69	18.0	0.63					40																													
35	18.6	0.78	18.8	0.77					35	18.5	0.50	18.9	0.49					35																													
30	19.5	0.64	19.8	0.62					30	19.5	0.36	19.8	0.35					30																													
25	20.3	0.53	20.8	0.47					27	20.1	0.29	20.4	0.27					35																													
20	21.0	0.43																35																													
15	21.3	0.40																35																													
7	21.7	0.30																35																													
Critical boom angle	6°		24°		44°		59°		Critical boom angle	26°		26°		44°		59°		Critical boom angle	34°		34°		44°		59°																						
Standard hook	For 3.2 ton														Standard hook	For 3.2 ton														Standard hook	For 3.2 ton																
Hook mass	60kg														Hook mass	60kg														Hook mass	60kg																
Parts of line	1														Parts of line	1														Parts of line	1																

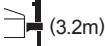

19.6m Boom + 4.0m Jib

 (3.2m)								
Outriggers intermediately extended (3.2m) - over side								
Boom angle (°)	Offset 7°		Offset 25°		Offset 45°		Offset 60°	
	Working radius (m)	Load (ton)	Working radius (m)	Load (ton)	Working radius (m)	Load (ton)	Working radius (m)	Load (ton)
83	2.7	2.50	3.9	2.00	4.9	1.50	5.4	1.20
80	3.9	2.50	5.1	2.00	6.0	1.50	6.5	1.20
75	6.0	2.50	7.1	2.00	7.9	1.50	8.3	1.20
73	6.8	2.50	7.8	2.00	8.6	1.50	9.0	1.20
70	8.0	2.35	9.0	2.00	9.7	1.50	10.0	1.20
67	9.2	1.75	10.1	1.55	10.7	1.40	11.0	1.20
65	9.8	1.50	10.8	1.30	11.3	1.25	11.6	1.15
60	11.5	0.92	12.4	0.82	12.9	0.79	13.2	0.73
55	13.1	0.53	13.9	0.48	14.3	0.47		
52	14.2	0.32	14.8	0.32	15.2	0.30		
Critical boom angle	51°		51°		51°		59°	
Standard hook	For 3.2 ton							
Hook mass	60kg							
Parts of line	1							



19.6m Boom + 5.8m Jib

 (5.4m)								 (4.8m)																							
Outriggers fully extended (5.4m) - 360° full range																Outriggers intermediately extended (4.8m) - over side															
Boom angle (°)	Offset 7°		Offset 25°		Offset 45°		Offset 60°		Boom angle (°)	Offset 7°		Offset 25°		Offset 45°		Offset 60°															
	Working radius (m)	Load (ton)	Working radius (m)	Load (ton)	Working radius (m)	Load (ton)	Working radius (m)	Load (ton)		Working radius (m)	Load (ton)	Working radius (m)	Load (ton)	Working radius (m)	Load (ton)	Working radius (m)	Load (ton)														
83	3.2	2.00	4.5	1.10	6.3	0.75	7.0	0.60	83	3.2	2.00	4.5	1.10	6.3	0.75	7.0	0.60														
80	4.6	2.00	6.1	1.10	7.4	0.75	8.1	0.60	80	4.6	2.00	6.1	1.10	7.4	0.75	8.1	0.60														
78	5.4	2.00	7.0	1.10	8.3	0.74	8.9	0.60	78	5.4	2.00	7.0	1.10	8.3	0.74	8.9	0.60														
75	6.7	2.00	8.2	1.05	9.4	0.72	10.0	0.60	75	6.7	2.00	8.2	1.05	9.4	0.72	10.0	0.60														
70	8.8	1.70	10.1	0.96	11.2	0.68	11.7	0.60	70	8.8	1.70	10.1	0.96	11.2	0.68	11.7	0.60														
65	10.8	1.40	12.0	0.87	13.0	0.66	13.3	0.60	65	10.8	1.40	12.0	0.87	13.0	0.66	13.3	0.60														
60	12.7	1.20	13.8	0.80	14.6	0.64	14.8	0.60	60	12.7	1.20	13.8	0.80	14.6	0.64	14.8	0.60														
55	14.5	1.05	15.5	0.75	16.1	0.63			55	14.5	1.05	15.5	0.75	16.1	0.63																
50	16.1	0.96	17.1	0.72	17.5	0.62			50	16.1	0.96	17.1	0.72	17.5	0.62																
45	17.6	0.88	18.3	0.69	18.8	0.60			48	16.8	0.90	17.6	0.71	18.0	0.61																
40	18.9	0.81	19.5	0.68					45	17.6	0.81	18.3	0.68	18.8	0.60																
37	19.7	0.77	20.2	0.67					40	18.9	0.61	19.6	0.58																		
35	20.2	0.70	20.7	0.65					35	20.2	0.43	20.6	0.43																		
30	21.2	0.57	21.6	0.55					30	21.2	0.32	21.5	0.32																		
25	21.9	0.48	22.4	0.45					27	21.5	0.28	22.0	0.26																		
20	22.7	0.39																													
15	23.1	0.35																													
7	23.5	0.23																													
Critical boom angle	6°		24°		44°		59°		Critical boom angle	26°		26°		44°		59°															
Standard hook	For 3.2 ton														Standard hook	For 3.2 ton															
Hook mass	60kg														Hook mass	60kg															
Parts of line	1														Parts of line	1															

19.6m Boom + 5.8m Jib

 (4.3m)								 (3.2m)																							
Outriggers intermediately extended (4.3m) - over side																Outriggers intermediately extended (3.2m) - over side															
Boom angle (°)	Offset 7°		Offset 25°		Offset 45°		Offset 60°		Boom angle (°)	Offset 7°		Offset 25°		Offset 45°		Offset 60°															
	Working radius (m)	Load (ton)	Working radius (m)	Load (ton)	Working radius (m)	Load (ton)	Working radius (m)	Load (ton)		Working radius (m)	Load (ton)	Working radius (m)	Load (ton)	Working radius (m)	Load (ton)	Working radius (m)	Load (ton)														
83	3.2	2.00	4.5	1.10	6.3	0.75	7.0	0.60	83	3.2	2.00	4.5	1.10	6.3	0.75	7.0	0.60														
80	4.6	2.00	6.1	1.10	7.4	0.75	8.1	0.60	80	4.6	2.00	6.1	1.10	7.4	0.75	8.1	0.60														
78	5.4	2.00	7.0	1.10	8.3	0.74	8.9	0.60	78	5.4	2.00	7.0	1.10	8.3	0.74	8.9	0.60														
75	6.7	2.00	8.2	1.05	9.4	0.72	10.0	0.60	75	6.7	2.00	8.2	1.05	9.4	0.72	10.0	0.60														
70	8.8	1.70	10.1	0.96	11.2	0.68	11.7	0.60	70	8.8	1.70	10.1	0.96	11.2	0.68	11.7	0.60														
65	10.8	1.40	12.0	0.87	13.0	0.66	13.3	0.60	68	9.7	1.50	10.9	0.92	12.0	0.67	12.4	0.60														
60	12.7	1.20	13.8	0.80	14.6	0.64	14.8	0.60	65	10.8	1.30	12.0	0.87	13.0	0.66	13.3	0.60														
55	14.5	1.05	15.5	0.75	16.1	0.63			60	12.7	0.79	13.9	0.70	14.6	0.63	14.8	0.60														
54	14.8	1.00	15.8	0.74	16.4	0.63			55	14.4	0.45	15.5	0.41	16.1	0.40																
50	16.1	0.80	17.1	0.71	17.5	0.62			52	15.5	0.28	16.4	0.27	17.0	0.25																
45	17.6	0.55	18.4	0.52	18.8	0.50																									
40	18.9	0.37	19.6	0.35																											
36	19.9	0.25	20.4	0.25																											
Critical boom angle	35°		35°		44°		59°		Critical boom angle	51°		51°		51°		59°															
Standard hook	For 3.2 ton														Standard hook	For 3.2 ton															
Hook mass	60kg														Hook mass	60kg															
Parts of line	1														Parts of line	1															



28.0m Boom + 4.0m Jib

 (5.4m)								 (4.8m)								 (4.3m)																															
Outriggers fully extended (5.4m) - 360° full range																Outriggers intermediately extended (4.8m) - over side																Outriggers intermediately extended (4.3m) - over side															
Boom angle (°)	Offset 7°		Offset 25°		Offset 45°		Offset 60°		Boom angle (°)	Offset 7°		Offset 25°		Offset 45°		Offset 60°		Boom angle (°)	Offset 7°		Offset 25°		Offset 45°		Offset 60°																						
	Working radius (m)	Load (ton)	Working radius (m)	Load (ton)	Working radius (m)	Load (ton)	Working radius (m)	Load (ton)		Working radius (m)	Load (ton)	Working radius (m)	Load (ton)	Working radius (m)	Load (ton)	Working radius (m)	Load (ton)		Working radius (m)	Load (ton)	Working radius (m)	Load (ton)	Working radius (m)	Load (ton)	Working radius (m)	Load (ton)	Working radius (m)	Load (ton)																			
83	4.2	2.50	5.4	2.00	6.4	1.50	6.8	1.20	83	4.2	2.50	5.4	2.00	6.4	1.50	6.8	1.20	83	4.2	2.50	5.4	2.00	6.4	1.50	6.8	1.20																					
80	6.0	2.50	7.2	2.00	8.0	1.50	8.4	1.20	80	6.0	2.50	7.2	2.00	8.0	1.50	8.4	1.20	80	6.0	2.50	7.2	2.00	8.0	1.50	8.4	1.20																					
77	7.8	2.50	8.9	2.00	9.6	1.50	10.0	1.20	77	7.8	2.50	8.9	2.00	9.6	1.50	10.0	1.20	77	7.8	2.50	8.9	2.00	9.6	1.50	10.0	1.20																					
75	9.0	2.50	9.9	1.90	10.7	1.50	11.0	1.20	75	9.0	2.50	9.9	1.90	10.7	1.50	11.0	1.20	75	9.0	2.50	9.9	1.90	10.7	1.50	11.0	1.20																					
70	11.6	2.05	12.5	1.65	13.2	1.35	13.4	1.20	70	11.6	2.05	12.5	1.65	13.2	1.35	13.4	1.20	70	11.6	2.15	11.5	1.70	12.2	1.40	12.9	1.20																					
65	14.2	1.65	15.0	1.40	15.6	1.20	15.7	1.20	65	13.1	1.80	14.0	1.50	14.7	1.25	14.8	1.20	65	11.6	1.95	12.5	1.60	13.2	1.35	13.4	1.20																					
60	16.5	1.30	17.3	1.20	17.7	1.10	17.9	1.10	60	14.2	1.56	15.0	1.40	15.6	1.20	15.7	1.20	60	13.2	1.48	14.1	1.36	14.7	1.23	14.8	1.20																					
57	17.9	1.10	18.6	1.05	18.9	1.02			57	15.1	1.33	16.0	1.23	16.5	1.15	16.6	1.15	57	14.0	1.27	15.0	1.14	15.6	1.09	15.7	1.08																					
55	18.7	0.96	19.5	0.90	19.7	0.89			55	16.4	1.05	17.2	0.99	17.7	0.96	17.9	0.93	55	16.3	0.79	17.2	0.72	17.6	0.71	17.9	0.65																					
50	20.7	0.66	21.3	0.64	21.6	0.63			50	18.6	0.68	19.3	0.65	19.7	0.63			50	18.4	0.47	19.2	0.43	19.5	0.43																							
45	22.5	0.45	23.0	0.44	23.4	0.41			45	20.5	0.43	21.2	0.40	21.5	0.40			45	19.7	0.31	20.4	0.29	20.7	0.29																							
40	24.2	0.28	24.6	0.28					40	21.7	0.30	22.2	0.30	22.5	0.29			40																													
38	24.8	0.23	25.3	0.22					38									38																													
Critical boom angle	37°		37°		44°		59°		Critical boom angle	46°		46°		46°		59°		Critical boom angle	51°		51°		51°		59°																						
Standard hook	For 3.2 ton																For 3.2 ton																														
Hook mass	60kg																60kg																														
Parts of line	1																1																														

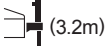

28.0m Boom + 4.0m Jib

 (3.2m)								
Outriggers intermediately extended (3.2m) - over side								
Boom angle (°)	Offset 7°		Offset 25°		Offset 45°		Offset 60°	
	Working radius (m)	Load (ton)	Working radius (m)	Load (ton)	Working radius (m)	Load (ton)	Working radius (m)	Load (ton)
83	4.2	2.50	5.4	2.00	6.4	1.50	6.8	1.20
80	6.0	2.50	7.2	2.00	8.0	1.50	8.4	1.20
77	7.8	2.50	8.9	2.00	9.6	1.50	10.0	1.20
75	8.8	2.10	9.9	1.80	10.7	1.50	11.0	1.20
73	10.0	1.60	10.9	1.45	11.7	1.30	12.0	1.20
70	11.3	1.17	12.3	1.04	13.1	0.95	13.4	0.92
65	13.7	0.60	14.7	0.53	15.3	0.51	15.5	0.50
Critical boom angle	64°		64°		64°		64°	
Standard hook	For 3.2 ton							
Hook mass	60kg							
Parts of line	1							

28.0m Boom + 5.8m Jib

 (5.4m)								 (4.8m)																							
Outriggers fully extended (5.4m) - 360° full range																Outriggers intermediately extended (4.8m) - over side															
Boom angle (°)	Offset 7°		Offset 25°		Offset 45°		Offset 60°		Boom angle (°)	Offset 7°		Offset 25°		Offset 45°		Offset 60°															
	Working radius (m)	Load (ton)	Working radius (m)	Load (ton)	Working radius (m)	Load (ton)	Working radius (m)	Load (ton)		Working radius (m)	Load (ton)	Working radius (m)	Load (ton)	Working radius (m)	Load (ton)	Working radius (m)	Load (ton)														
83	4.7	2.00	6.3	1.10	7.7	0.75	8.4	0.60	83	4.7	2.00	6.3	1.10	7.7	0.75	8.4	0.60														
80	6.6	2.00	8.1	1.10	9.3	0.74	10.0	0.60	80	6.6	2.00	8.1	1.10	9.3	0.74	10.0	0.60														
77	9.7	2.00	11.0	1.05	12.1	0.71	12.6	0.60	77	9.7	2.00	11.0	1.05	12.1	0.71	12.6	0.60														
70	12.6	1.65	13.7	0.93	14.6	0.68	15.1	0.60	70	12.6	1.65	13.7	0.93	14.6	0.68	15.1	0.60														
65	15.2	1.35	16.3	0.85	17.0	0.65	17.3	0.60	65	15.2	1.33	16.3	0.85	17.0	0.65	17.3	0.60														
60	17.6	1.15	18.7	0.78	19.4	0.63	19.5	0.60	60	16.2	1.21	17.2	0.82	18.0	0.64	18.2	0.60														
58	18.7	1.05	19.6	0.77	20.2	0.62			58	17.6	0.95	18.7	0.78	19.4	0.63	19.5	0.60														
55	20.0	0.87	20.9	0.74	21.4	0.62			55	19.1	0.72	20.0	0.70	20.6	0.62																
50	22.0	0.61	23.0	0.57	23.4	0.57			50	19.9	0.61	20.9	0.58	21.4	0.57																
45	24.0	0.41	24.7	0.40	24.8	0.40			45	21.9	0.38	22.8	0.37	23.3	0.35																
40	25.7	0.26	26.3	0.25					40	23.1	0.27	24.0	0.25	24.3	0.25																
38	26.4	0.20	27.0	0.20					38																						
Critical boom angle	37°		37°		44°		59°		Critical boom angle	46°		46°		46°		59°															
Standard hook	For 3.2 ton																														
Hook mass	60kg																														
Parts of line	1																														

28.0m Boom + 5.8m Jib

 (4.3m)								 (3.2m)																							
Outriggers intermediately extended (4.3m) - over side																Outriggers intermediately extended (3.2m) - over side															
Boom angle (°)	Offset 7°		Offset 25°		Offset 45°		Offset 60°		Boom angle (°)	Offset 7°		Offset 25°		Offset 45°		Offset 60°															
	Working radius (m)	Load (ton)	Working radius (m)	Load (ton)	Working radius (m)	Load (ton)	Working radius (m)	Load (ton)		Working radius (m)	Load (ton)	Working radius (m)	Load (ton)	Working radius (m)	Load (ton)	Working radius (m)	Load (ton)														
83	4.7	2.00	6.3	1.10	7.7	0.75	8.4	0.60	83	4.7	2.00	6.3	1.10	7.7	0.75	8.4	0.60														
80	6.6	2.00	8.1	1.10	9.3	0.74	10.0	0.60	80	6.6	2.00	8.1	1.10	9.3	0.74	10.0	0.60														
75	9.7	2.00	11.0	1.05	12.1	0.71	12.6	0.60	75	8.5	2.00	9.9	1.07	11.0	0.72	11.6	0.60														
70	12.6	1.65	13.7	0.93	14.6	0.68	15.1	0.60	70	10.0	1.73	11.0	1.05	12.1	0.71	12.6	0.60														
68	13.7	1.45	14.8	0.89	15.6	0.66	16.0	0.60	68	11.3	1.30	12.6	0.96	13.6	0.69	14.1	0.60														
65	15.1	1.14	16.3	0.85	17.0	0.65	17.3	0.60	65	12.3	1.03	13.7	0.89	14.6	0.68	15.1	0.60														
62	16.1	0.94	17.8	0.78	18.5	0.64	18.7	0.60	62	13.3	0.80	14.7	0.70	15.6	0.66	16.0	0.60														
60	17.4	0.72	18.7	0.65	19.4	0.62	19.5	0.60	60	14.7	0.54	16.3	0.44	17.0	0.44	17.3	0.43														
55	19.7	0.42	20.9	0.37	21.4	0.37			55																						
52	21.0	0.28	22.0	0.26	22.5	0.25			52																						
Critical boom angle	51°		51°		51°		59°		Critical boom angle	64°		64°		64°		64°															
Standard hook	For 3.2 ton																														
Hook mass	60kg																														
Parts of line	1																														

Notes for the lifting capacity chart

When the outriggers are used

- The lifting capacity chart indicates the maximum load which can be lifted by this crane provided it is level and standing on firm level ground. The values in the chart include the mass of the main hook and slings for boom operation, and auxiliary hook and slings for jib operation.
[20 ton hook (mass: 150 kg), 3.2 ton hook (mass: 60 kg)]
Within the chart the figures in the area bordered with a thick line are based on structural limitations while other figures are determined by stability limitations.
- The working radii are the actual values allowing for boom and jib deflection. Therefore you must always operate the crane on the basis of working radius.
- The jib working radii are based on the jib mounted on the end of 19.6m boom or the 28.0m boom. When operating the jib with the boom length 19.6m and 28.0m, refer the boom angle only at the 28.0m boom instead of its working radii.
When operating the jib with the boom lengths less than 19.6m, refer the boom angle only at the 19.6m boom instead of working radii.
- Do not operate the jib when the outriggers are completely retracted.
- The lifting capacities for the over sides vary with the outriggers extension width. Therefore for each outriggers extension condition you should work according the lifting capacity chart. Use the lifting capacity chart of outriggers full extension for both front and rear areas lifting capacities.

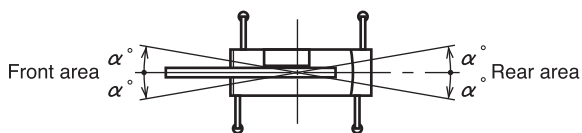

Outrigger extension status	Intermediate extension (4.8m)	Intermediate extension (4.3m)	Intermediate extension (3.2m)	Complete retraction
Area α°	30	20	15	3

- The lifting capacity of the rooster sheave is the lifting capacity of the boom minus the mass of all attached hook, slings etc. to the boom, with an upper limit of 3,200 kg.
[The hook for use with the rooster sheave is the 3.2 ton hook (mass: 60 kg) with one part of line.]
- If the boom length, boom angle, working radius and/or jib angle exceeds the rated value, use the lifting capacity for the rated value or for the next one, whichever gives the smaller lifting capacity.
- If you are working with the boom while the jib is rigged, subtract 1500 kg plus the mass of all attached hook, slings, etc. to the boom from the each lifting capacity of the boom, with an upper limit of 10 ton.
Do not use the rooster sheave in this situation. And do not operate the boom while the jib is rigged, when the outriggers are completely retracted.
- In whatever working conditions the corresponding boom critical angle is shown in the chart. The crane can tip over if the boom is lowered below the critical angle even if unloaded. Therefore, never lower the boom below these angles.
- The standard parts of line for each boom length are as indicated in the chart. If you work with a non-standard number of parts of line, do not exceed 28.4 kN (2.9 tf) per wire rope respectively.
- High-speed winch operation should only be performed to allow descent of the hook alone. Avoid sudden lever operation.
- Crane operation is permissible up to a wind speed of 10 m/s. Even in relatively light wind conditions, extra care should be taken when handling loads presenting large wind catching areas.
- If you work with a load in excess of the lifting capacity or use incorrect working procedures, you are risking damaging the crane or tipping it over. In such cases, the crane will not be guaranteed.

When the outriggers are not used

- The lifting capacity chart indicates the maximum load the crane can lift when its body is level on firm level ground with all tires inflated to the rated pressure and the suspension cylinder completely retracted. The values in the chart include the mass of the main hook and slings.
Within the chart the figures in the area bordered with a thick line are based on structural limitations while other figures are determined by stability limitations.
[Rated tire pressure: 900 kPa (9.00 kgf/cm²)]
- The working radii are the actual values allowing for boom deflection. Therefore you must always operate the crane on the basis of the working radius.
- The lifting capacity differs between the front area capacity and the full range capacity. When slewing from the front to the side, take care that the crane could not be over loaded.

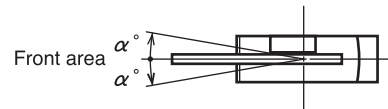

Crane operation	Stationary crane-on-rubber operation	Pick and carry operation
Area α°	1	1

- The lifting capacity of the rooster sheave is the lifting capacity of the boom minus the mass of all attached hook, slings etc. to the boom, with an upper limit of 3,200 kg.
[The hook for use with the rooster sheave is the 3.2 ton hook (mass: 60 kg) with one part of line.]
- Do not work with the jib or with a boom length of more than 19.6 m.
- For stationary crane-on-rubber operation, the parking brake and service brake lock device must be engaged.
- For pick and carry operation, the high/low speed switch must be switched to "ON" (low range) and the shift lever set to speed 1.
- For pick and carry operation, lower the load to just above the ground and keep your speed strictly below 2 km/h to avoid swinging the load.
Take particular care to avoid sharp turns, sudden starts and stops.
- Never operate the crane during pick and carry operation. The slewing brake must be applied.
- If the boom length, boom angle, working radius and/or jib angle exceeds the rated value, use the lifting capacity for the rated value or for the next one, whichever gives the smaller lifting capacity.
- In whatever working conditions the corresponding boom critical angle is shown in the chart. The crane can tip over if the boom is lowered below the critical angle even if unloaded. Therefore, never lower the boom below these angles.
- The standard parts of line for each boom length are as indicated in the chart. If you work with a non-standard number of parts of line, do not exceed 28.4 kN (2.9 tf) per wire rope respectively.
- High-speed lowering operation should only be performed to allow descent of the hook alone. Avoid sudden lever operation.
- Crane operation is permissible up to a wind speed of 10 m/s. Even in relatively light wind conditions, extra care should be taken when handling loads presenting large wind catching areas.
- If you work with a load in excess of the rated lifting capacity or use incorrect working procedures, you are risking damaging the crane or tipping it over. In such cases, the crane will not be guaranteed.

WORKING RANGE

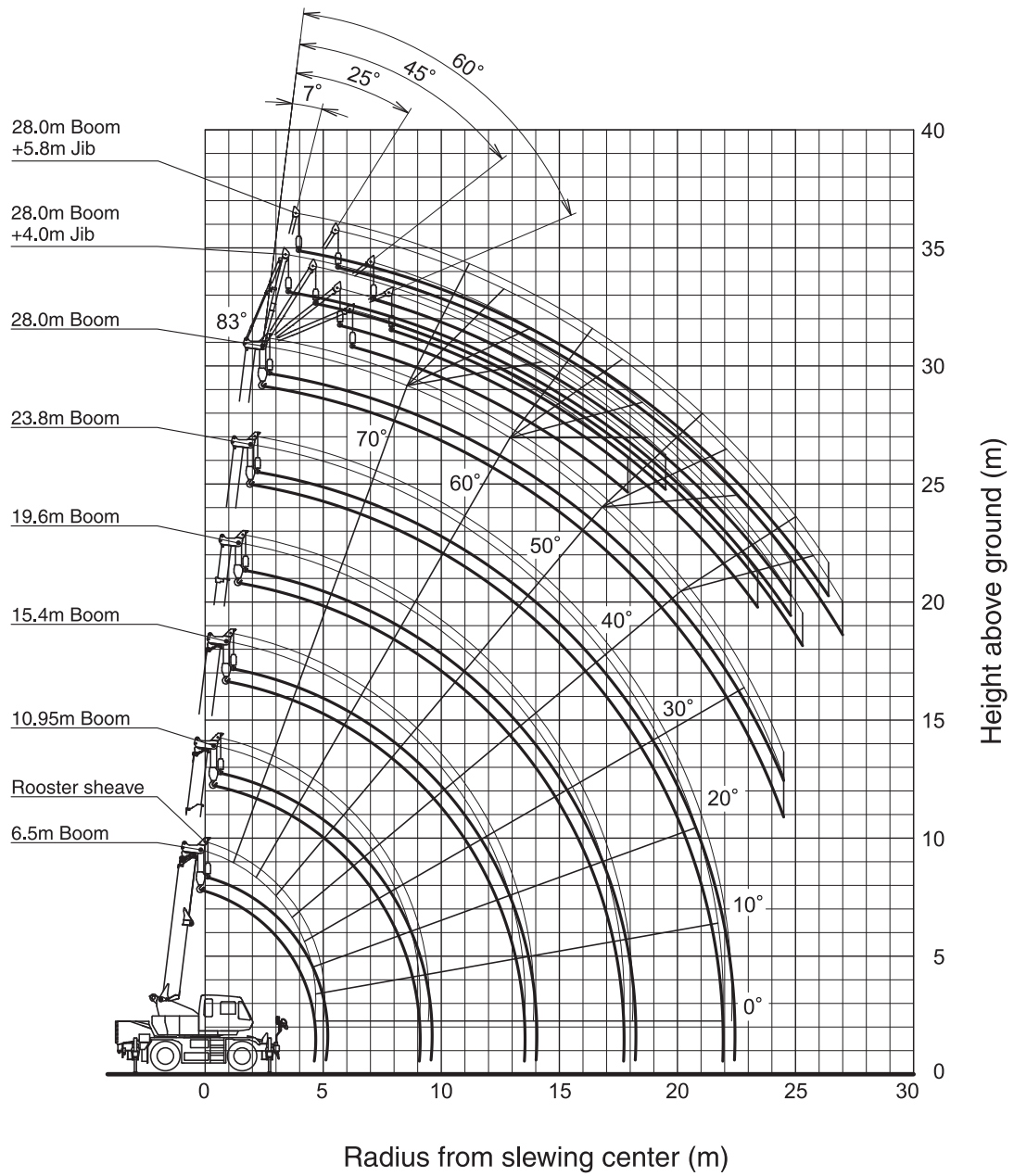

Notes:

1. This diagram does not include deflection of Boom and Jib.
2. The outriggers are fully extended.

Minimum path width

● Right turn in two-wheel steering mode

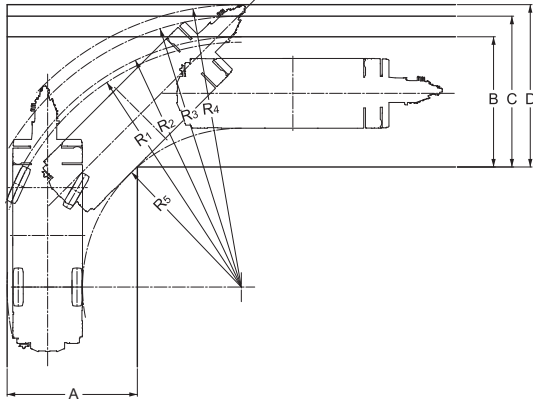

- $R_1=8.00\text{m}$
(Minimum turning radius)
- $R_2=8.18\text{m}$
(Turning radius of extremely outer tire)
- $R_3=8.85\text{m}$
(Chassis turning radius)
- $R_4=9.23\text{m}$
(Boom end turning radius)
- $R_5=5.19\text{m}$
(Turning radius extremely chassis inner)
- $A=4.26\text{m}$ (Width of entrance)
- $B=4.26\text{m}$ (Width of wheel exit)
- $C=4.93\text{m}$ (Width of chassis exit)
- $D=5.31\text{m}$ (Width of exit at end of boom)

● Right turn in 4-wheel steering mode

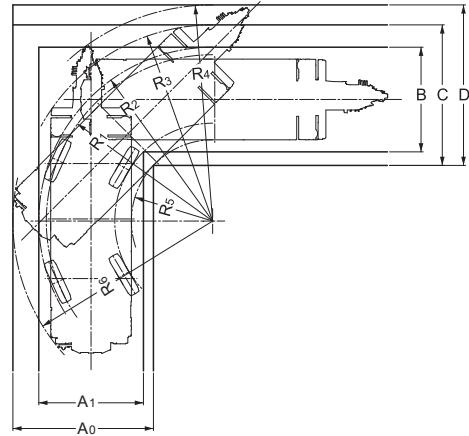

- $R_1=4.70\text{m}$
(Minimum turning radius)
- $R_2=4.91\text{m}$
(Turning radius of extremely outer tire)
- $R_3=5.54\text{m}$
(Chassis turning radius)
- $R_4=6.11\text{m}$
(Boom end turning radius)
- $R_5=2.30\text{m}$
(Turning radius extremely chassis inner)
- $R_5=5.64\text{m}$
(Turning radius at the rear end of the chassis)
- $A_0=3.97\text{m}$ (Width of chassis entrance)
- $A_1=2.96\text{m}$ (Width of wheel entrance)
- $B=2.96\text{m}$ (Width of wheel exit)
- $C=3.97\text{m}$ (Width of chassis exit)
- $D=4.54\text{m}$ (Width of exit at end of boom)

Note: The above values are based on calculations.

Overall view

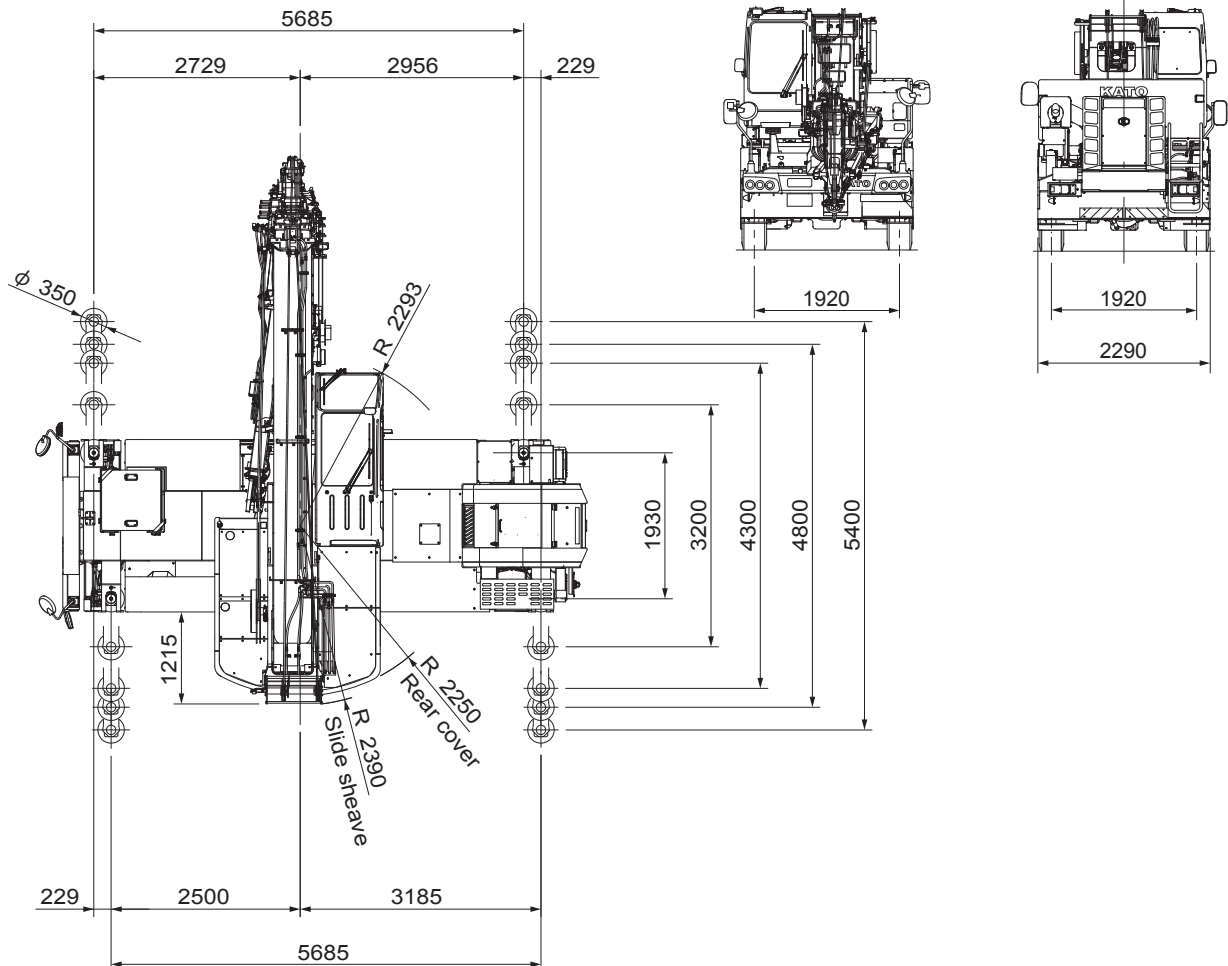

Reduced scale: 1/100 Unit (mm)

Overall view

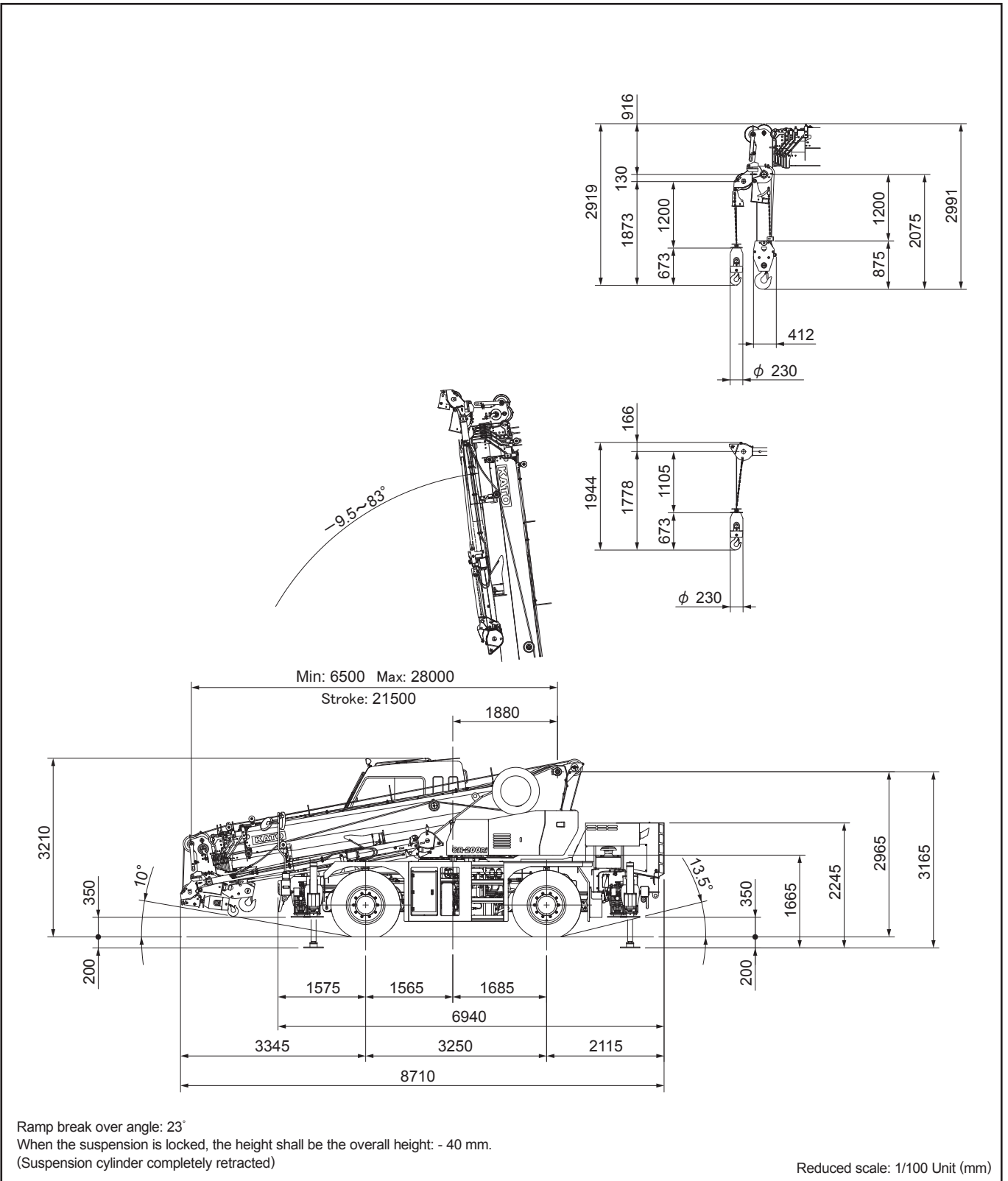

* KATO products and specifications are subject to improvements and changes without notice.

Address inquiries to:

KATO
KATO WORKS CO.,LTD.

9-37, Higashi-ohi 1-chome, Shinagawa-ku, Tokyo, 140-0011, Japan
 Tel. : Head Office Tokyo (03) 3458-1111
 Overseas Marketing Department. Tokyo (03) 3458-1115
 Fax. : Tokyo (03) 3458-1152
 URL <http://www.kato-works.co.jp>

C03871
1.2015-1000 (TI) 1



We acquired the "ISO 9001" certification which is an international standard for quality assurance.