



HC 110-1

110 USt lifting capacity

Crawler crane

Datasheet

imperial

HC 110-1



WORKS FOR YOU.™

	Page:
Highlights	4
Specifications	5
Dimensions	6-7

59HI Offset Tip Boom	
Range Diagram	8
Load Charts	9
Notes to Lifting Capacity	11

59HI Offset Tip Boom + 9HL Jib	
Range Diagram	12
Load Charts	13
Notes to Lifting Capacity	17

Technical description	18
------------------------------------	----

Load Plan for HC 110-1	19
-------------------------------------	----



	Counterweight
	Track
	Central ballast
	Main boom
	Fly jib
	Wind speed in ft/s (feet per second)

- ▶ 110 US ton maximum lifting capacity
- ▶ Power up/down standard
- ▶ Free fall on main and auxiliary drums
- ▶ Quiet, comfortable operator's cab with excellent viewing range
- ▶ Shockless stop system gradually retards operating speed to reduce shocks when crane approaches lifting load or boom limits
- ▶ Two speed travel allows operator to select the best speed and power control for any condition
- ▶ Superior transportability:
12 ft width
10 ft - 9 in ft height
- ▶ Hydraulic counterweight removal system simplifies installation and removal

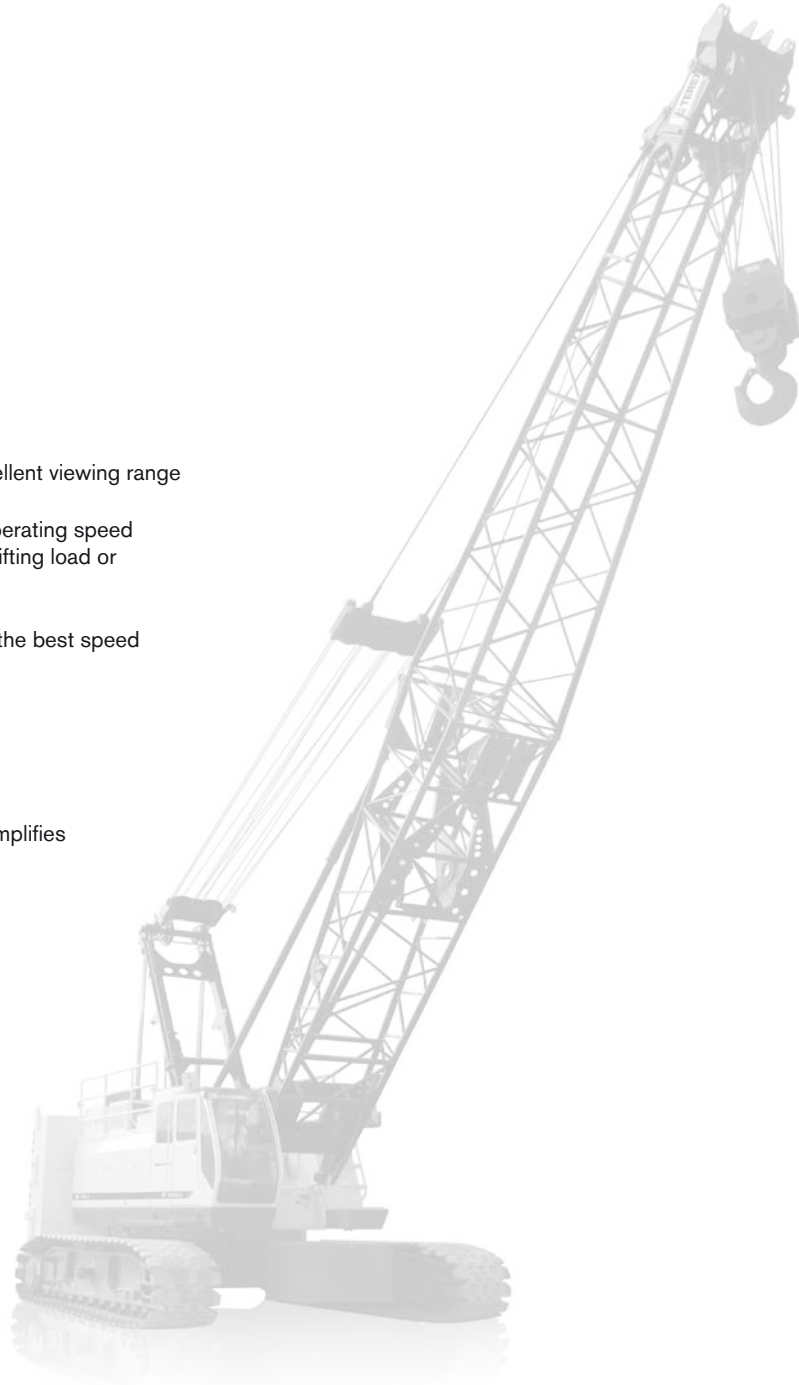

Working speeds (infinitely variable)

Mechanism	Rope ø	Speeds ¹⁾	Single line pull ²⁾	Length of hoist rope
Main hoist	26 mm	max. 566 ft/min	42,108 lb	1148 ft
Auxiliary hoist	26 mm	max. 566 ft/min	42,108 lb	1148 ft
Boom hoist	20 mm	max. 356 ft/min	15,600 lb	590 ft
Slewing (rpm)		2.4		

1) top layer

2) bottom layer

– Above figures based on engine rated output at 2,000 rpm.

– Line speed will change subject to load.

Carrier performance

Ground speed	0.93 mph (1.5 km/h)
--------------	---------------------

Hook block

Type	Possible load	Number of sheaves	Number of lines	Weight	Hook version
120	240,000 lb	4	8	3,200 lb	single
110	220,000 lb	4	8	3,200 lb	single
75	150,000 lb	3	5	1,500 lb	single
50	100,000 lb	2	4	935 lb	single
25	50,000 lb	1	2	435 lb	single
15	30,000 lb	0	1	755 lb	single

DIMENSIONS

HC 110-1

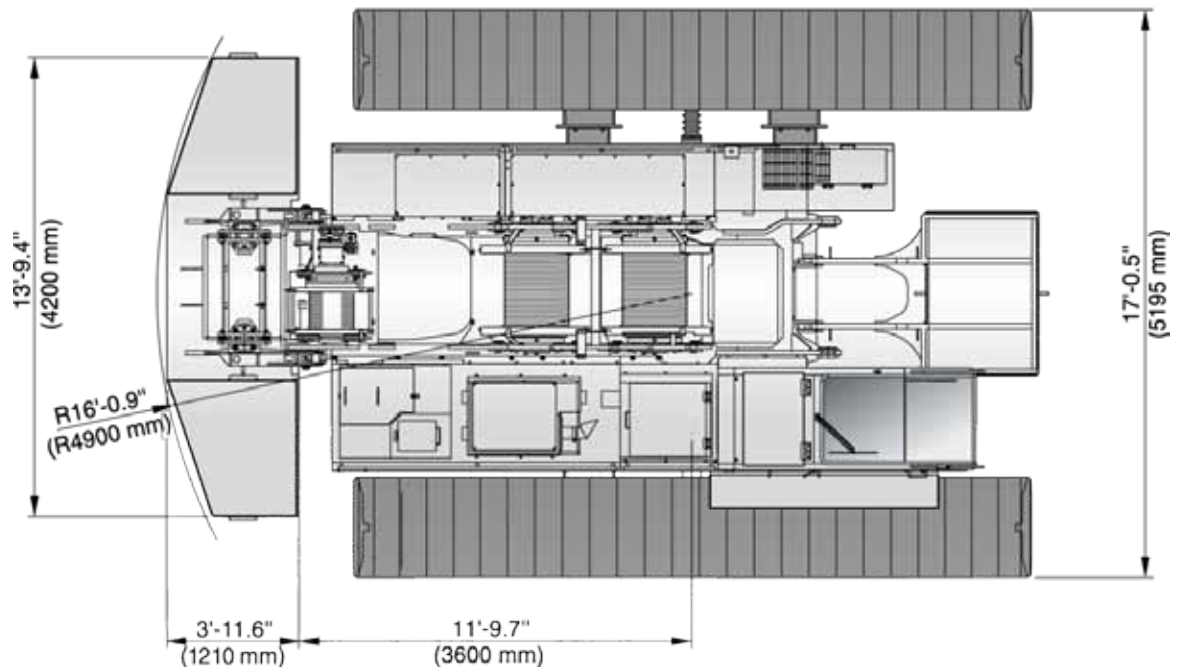
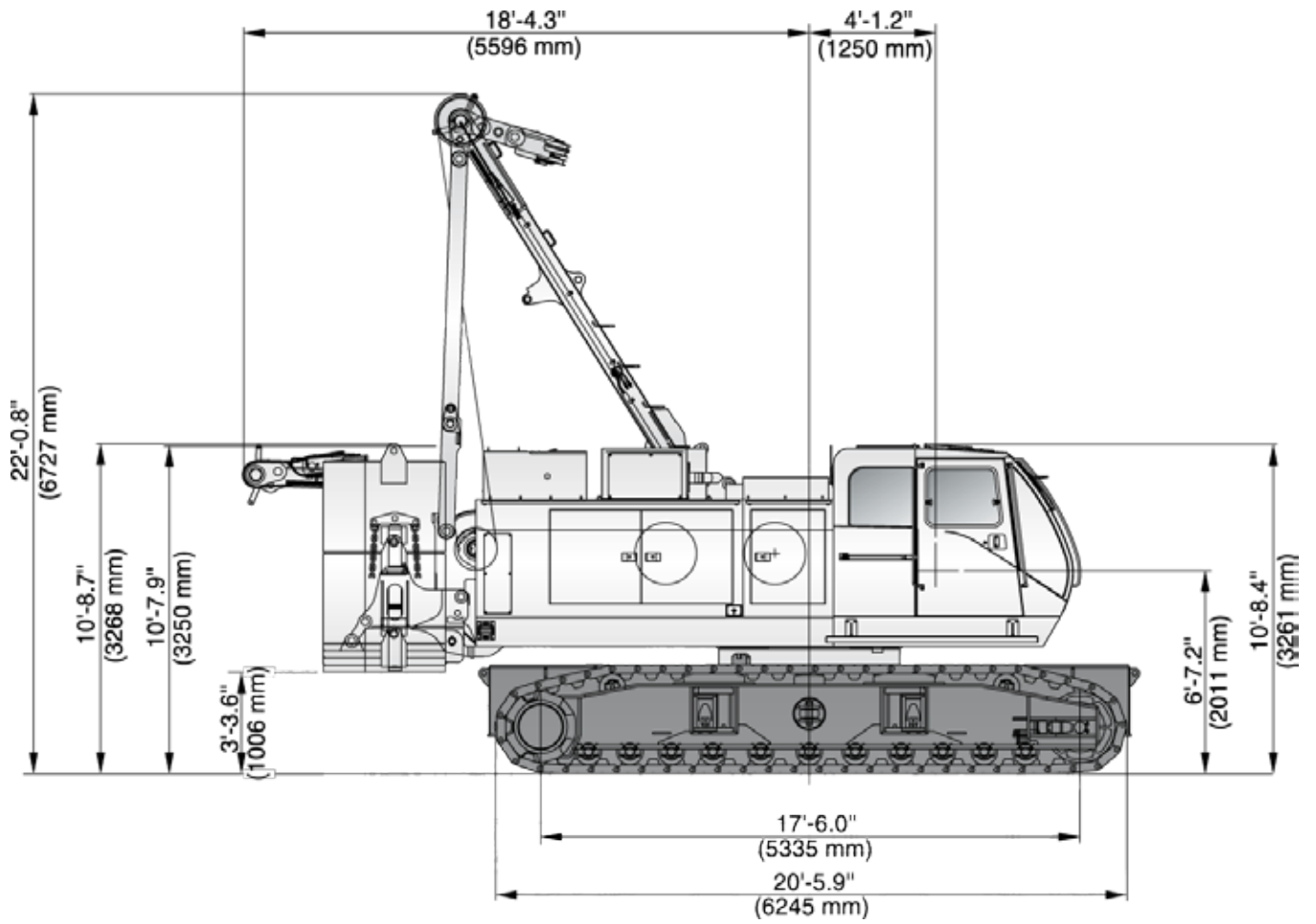

DIMENSIONS

HC 110-1

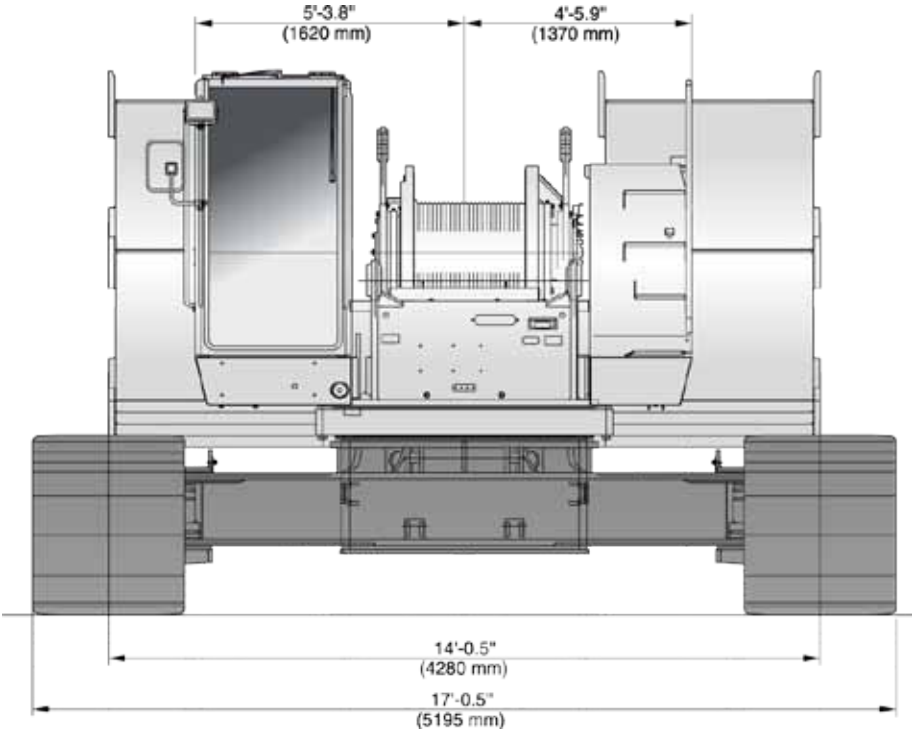
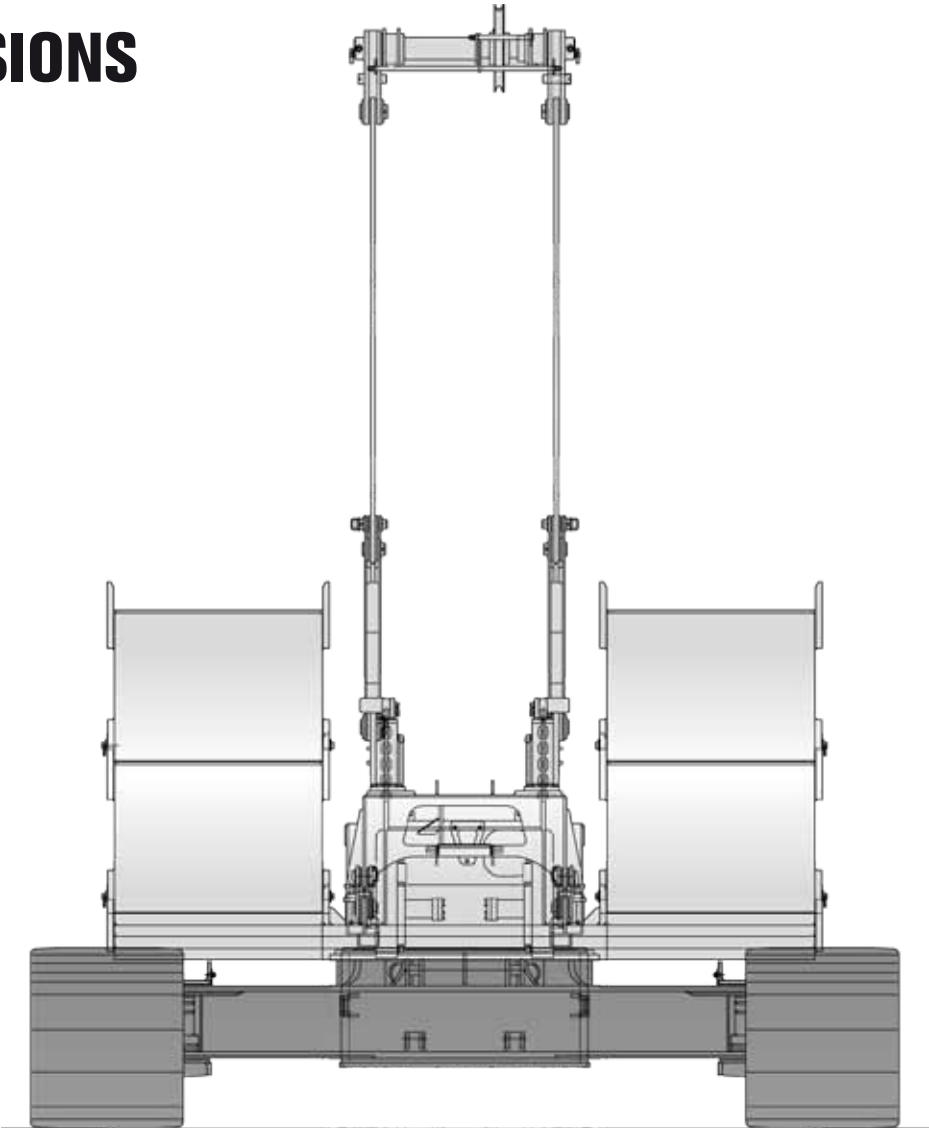

RANGE DIAGRAM

HC 110-1



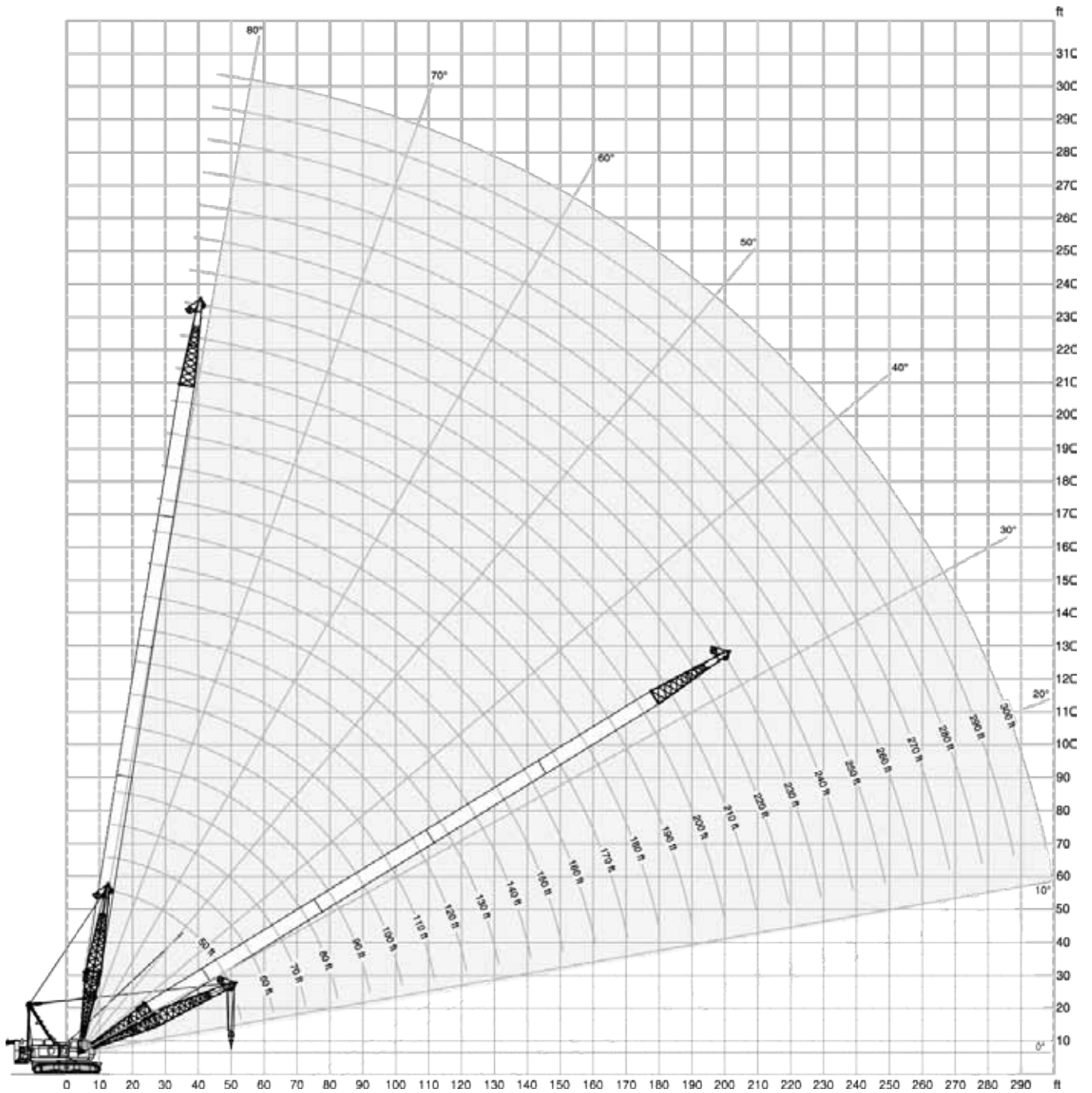



59HI Offset Tip Boom





LOAD CHART

HC 110-1

with 59HI Offset Tip Boom

		70,875 lb +  30,865 lb		 14 ft		 44.0 / 29.3 ft/s**		360°		ANSI B 30.5		
		50.0 ft	60.0 ft	70.0 ft	80.0 ft	90.0 ft	100.0 ft	110.0 ft	120.0 ft	130.0 ft	140.0 ft	
ft	lb	lb	lb	lb	lb	lb	lb	lb	lb	lb	lb	ft
13	220000*	-	-	-	-	-	-	-	-	-	-	13
14	220000*	-	-	-	-	-	-	-	-	-	-	14
15	207240*	207070*	-	-	-	-	-	-	-	-	-	15
16	189920	189740	189580	-	-	-	-	-	-	-	-	16
17	170130	169950	169790	-	-	-	-	-	-	-	-	17
18	153940	153740	153570	153360	-	-	-	-	-	-	-	18
19	140610	140420	140260	140050	139900	-	-	-	-	-	-	19
20	129290	129090	128920	128710	128540	-	-	-	-	-	-	20
21	119620	119410	119240	119010	118830	118610	-	-	-	-	-	21
22	111370	111170	111000	110790	110630	110420	110220	-	-	-	-	22
25	91960	91740	91560	91320	91150	90920	90710	90470	-	-	-	25
30	71080	70870	70690	70460	70290	70060	69840	69610	69410	69180	69180	30
35	57760	57560	57380	57170	57010	56790	56590	56360	56170	55950	55950	35
40	48460	48250	48070	47840	47670	47440	47220	46990	46790	46560	46560	40
45	41630	41400	41220	40980	40800	40560	40350	40100	39910	39670	39670	45
50	36400	36160	35980	35720	35550	35300	35090	34830	34630	34380	34380	50
55	-	32030	31830	31580	31400	31150	30930	30670	30470	30210	30210	55
60	-	28740	28560	28340	28180	27950	27740	27520	27330	27090	27090	60
65	-	-	25790	25550	25390	25160	24960	24720	24530	24300	24300	65
70	-	-	23450	23220	23050	22820	22620	22370	22190	21940	21940	70
75	-	-	-	21230	21060	20820	20610	20380	20180	19950	19950	75
80	-	-	-	19520	19350	19100	18890	18660	18460	18210	18210	80
85	-	-	-	-	17860	17610	17390	17160	16960	16710	16710	85
90	-	-	-	-	16540	16300	16080	15840	15640	15390	15390	90
95	-	-	-	-	-	15140	14920	14670	14470	14220	14220	95
100	-	-	-	-	-	14110	13880	13630	13430	13180	13180	100
105	-	-	-	-	-	-	12960	12690	12490	12250	12250	105
110	-	-	-	-	-	-	12130	11860	11650	11400	11400	110
115	-	-	-	-	-	-	-	11100	10900	10640	10640	115
120	-	-	-	-	-	-	-	10430	10210	9950	9950	120
125	-	-	-	-	-	-	-	-	9580	9310	9310	125
130	-	-	-	-	-	-	-	-	9010	8740	8740	130
135	-	-	-	-	-	-	-	-	-	8210	8210	135
140	-	-	-	-	-	-	-	-	-	7730	7730	140
145	-	-	-	-	-	-	-	-	-	-	-	145

Asterisk (*) areas on this chart indicate ratings that are limited by strength of material or factors other than stability (tipping)



**  44.0 ft/s (boom < 220 ft)
 29.3 ft/s (boom > 220 ft)

LOAD CHART

HC 110-1

with 59HI Offset Tip Boom

 70,875 lb +  30,865 lb
  14 ft
  44.0/29.3 ft/s**
 360°
 ANSI B 30.5

			150.0 ft	160.0 ft	170.0 ft	180.0 ft	190.0 ft	200.0 ft	210.0 ft	220.0 ft	230.0 ft	
	ft	lb	lb	lb	lb	lb	lb	lb	lb	lb	lb	ft
30		68950	68720	-	-	-	-	-	-	-	-	30
35		55730	55510	55310	55080	52520*	-	-	-	-	-	35
40		46340	46100	45900	45670	45450	45210	41230*	36480*	-	-	40
45		39440	39200	38990	38740	38510	38280	38050	35010*	31150*	-	45
50		34160	33900	33690	33450	33210	32960	32740	32500	29790*	-	50
55		29980	29720	29510	29250	29020	28770	28960	28730	27420*	-	55
60		26880	26650	26440	26210	26000	25760	25560	25320	25100	-	60
65		24080	23840	23640	23410	23180	22950	22740	22510	22290	-	65
70		21730	21490	21280	21050	20830	20590	20370	20140	19910	-	70
75		19720	19480	19280	19030	18810	18570	18360	18120	17890	-	75
80		17990	17760	17540	17300	17080	16830	16620	16380	16160	-	80
85		16490	16240	16040	15790	15560	15320	15100	14860	14630	-	85
90		15160	14920	14710	14470	14240	13990	13780	13540	13300	-	90
95		13990	13740	13540	13300	13060	12820	12590	12350	12120	-	95
100		12950	12700	12490	12240	12010	11760	11550	11300	11060	-	100
105		12020	11760	11550	11310	11070	10820	10600	10360	10120	-	105
110		11170	10920	10700	10460	10220	9980	9750	9510	9270	-	110
115		10410	10150	9940	9680	9460	9200	8980	8730	8500	-	115
120		9710	9460	9240	8990	8760	8500	8280	8030	7790	-	120
125		9070	8820	8600	8350	8110	7860	7640	7390	7150	-	125
130		8500	8230	8020	7760	7520	7270	7050	6800	6560	-	130
135		7970	7710	7480	7220	6990	6730	6510	6260	6010	-	135
140		7480	7210	6990	6730	6490	6230	6010	5760	5510	-	140
145		7020	6750	6530	6270	6030	5770	5540	5300	5050	-	145
150		6620	6330	6110	5850	5610	5340	5110	4870	4620	-	150
155		-	5950	5720	5450	5210	4950	4710	4460	4220	-	155
160		-	5400	5350	5080	4830	4580	4350	4090	3850	-	160
165		-	-	5020	4740	4490	4230	4000	3740	3500	-	165
170		-	-	4380	4420	4180	3910	3670	3420	3170	-	170
175		-	-	-	4070	3880	3600	3360	3110	2860	-	175
180		-	-	-	3330	3600	3320	3080	2820	2570	-	180
185		-	-	-	-	3080	3060	2820	2560	2300	-	185
190		-	-	-	-	2420	2650	2570	2300	2050	-	190
195		-	-	-	-	-	2100	2290	2060	1810	-	195
200		-	-	-	-	-	1500	1800	1780	1590	-	200

Asterisk (*) areas on this chart indicate ratings that are limited by strength of material or factors other than stability (tipping)

******  44.0 ft/s (boom < 220 ft)
 29.3 ft/s (boom > 220 ft)

NOTES TO LIFTING CAPACITY

HC 110-1

Main Boom Chart Information

59HI Offset Tip Boom

Boom length (ft)	25' 59HI Inner	10' 59H Center	20' 59H Center	40' 59H Center	25' 59HI Outer
50	1	0	0	0	1
60	1	1	0	0	1
70	1	0	1	0	1
80	1	1	1	0	1
90	1	0	0	1	1
100	1	1	0	1	1
110	1	0	1	1	1
120	1	1	1	1	1
130	1	0	0	2	1
140	1	1	0	2	1
150	1	0	1	2	1
160	1	1	1	2	1
170	1	0	0	3	1
180	1	1	0	3	1
190	1	0	1	3	1
200	1	1	1	3	1
210	1	0	0	4	1
220	1	1	0	4	1
230	1	0	1	4	1

RANGE DIAGRAM

HC 110-1

59HI Offset Tip Boom + 9HL Jib

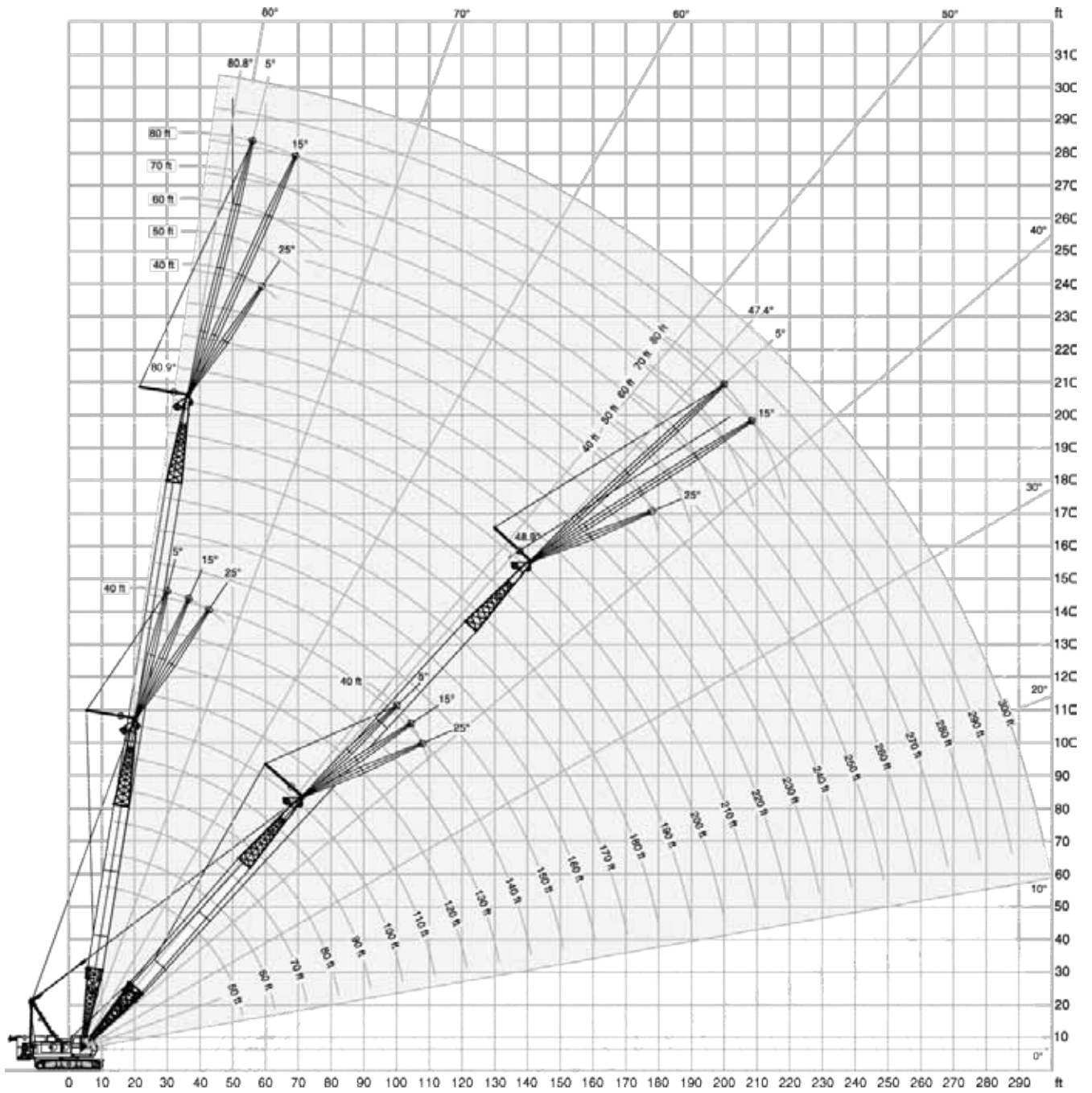

LOAD CHART

HC 110-1

with 59H Offset Tip Boom + 9HL Jib

 70,875 lb +  30,865 lb 360° ANSI B 30.5

40' Jib length													
ft	100 ft			110 ft			120 ft			130 ft			ft
	5°	15°	25°	5°	15°	25°	5°	15°	25°	5°	15°	25°	
lb	lb	lb	lb	lb	lb	lb	lb	lb	lb	lb	lb	lb	
29	-	-	-	-	-	-	-	-	-	-	-	-	29
30	22540*	-	-	-	-	-	-	-	-	-	-	-	30
35	22540*	-	-	22530*	-	-	22520*	-	-	22500*	-	-	35
40	22470*	21300*	-	22530*	21400*	-	22520*	21510*	-	22500*	-	-	40
50	21770*	20740*	19890*	21940*	20840*	19910*	22090*	20960*	20030*	22280*	21000*	20040*	50
60	21160*	20220*	19480*	21380*	20350*	19520*	21490*	20460*	19620*	21690*	20570*	19730*	60
70	20570*	19790*	18420*	20820*	19950*	18970*	21020*	20030*	19280*	21210*	20210*	19380*	70
80	19560	19420*	17090*	19310	19310	17610*	19050	19050	18070*	18810	18810	18530*	80
90	16740	16740	15930*	16480	16480	16440*	16210	16220	16220	15990	15990	15990	90
100	14520	14520	14530	14270	14270	14280	14000	14010	14010	13770	13770	13770	100
110	-	-	-	12480	12490	12490	12220	12220	12220	11990	11990	11990	110
120	-	-	-	-	-	-	10760	10760	10760	10520	10520	10520	120
130	-	-	-	-	-	-	-	-	-	9290	9300	9300	130

40' Jib length													
ft	140 ft			150 ft			160 ft			170 ft			ft
	5°	15°	25°	5°	15°	25°	5°	15°	25°	5°	15°	25°	
lb	lb	lb	lb	lb	lb	lb	lb	lb	lb	lb	lb	lb	
40	22490*	-	-	22470*	-	-	22460*	-	-	-	-	-	40
50	22380*	21090*	20100*	22470*	21230*	-	22460*	21270*	-	22450*	21320*	-	50
60	21860*	20670*	19720*	21980*	20770*	19850*	22100*	20870*	19890*	22240*	20900*	19940*	60
70	21350*	20280*	19460*	21470*	20400*	19490*	21610*	20470*	19560*	21560	20540*	19670*	70
80	18550	18560	18560	18310	18310	18310	18050	18060	18060	17830	17830	17830	80
90	15720	15720	15730	15480	15480	15480	15220	15220	15220	14990	15000	15000	90
100	13510	13510	13510	13260	13270	13270	13000	13000	13000	12770	12770	12780	100
110	11720	11720	11720	11470	11470	11480	11220	11220	11220	10980	10980	10980	110
120	10250	10250	10260	10000	10000	10010	9740	9750	9750	9510	9510	9510	120
130	9030	9040	9040	8780	8790	8790	8520	8520	8520	8280	8280	8280	130
140	8000	8000	8000	7740	7740	7740	7480	7480	7480	7240	7240	7240	140
150	-	-	-	6850	6850	6860	6580	6580	6590	6350	6350	6360	150
160	-	-	-	-	-	-	5810	5810	5810	5580	5580	5580	160
170	-	-	-	-	-	-	-	-	-	4900	4900	4910	170
180	-	-	-	-	-	-	-	-	-	-	-	-	180



40' Jib length													
ft	180 ft			190 ft			200 ft			210 ft			ft
	5°	15°	25°	5°	15°	25°	5°	15°	25°	5°	15°	25°	
lb	lb	lb	lb	lb	lb	lb	lb	lb	lb	lb	lb	lb	
50	22430*	21380*	-	21560*	-	-	18760*	-	-	16270*	-	-	50
60	22350*	20950*	19900*	20450*	19210*	17880*	17610*	16680*	15600*	15220*	14450*	13550*	60
70	21320	20600*	19670*	19300*	18400*	17330*	16560*	15840*	15040*	14220*	13630*	12990*	70
80	17570	17580	17580	17330	17330	16700*	15570*	14960*	14330*	13260*	12810*	12330*	80
90	14740	14740	14740	14490	14500	14500	14240	14150*	13690*	12340*	12010*	11620*	90
100	12520	12520	12520	12270	12270	12270	12010	12020	12020	11460*	11210*	10980*	100
110	10720	10720	10730	10480	10480	10480	10220	10220	10230	9990	9990	9990	110
120	9250	9250	9260	9000	9010	9010	8750	8750	8750	8510	8510	8520	120
130	8020	8020	8030	7770	7770	7780	7520	7520	7520	7280	7280	7280	130
140	6980	6980	6990	6730	6730	6740	6480	6480	6480	6240	6240	6240	140
150	6080	6080	6090	5830	5840	5840	5580	5580	5580	5340	5340	5340	150
160	5320	5320	5320	5070	5070	5070	4800	4800	4800	4560	4560	4560	160
170	4630	4630	4640	4380	4380	4390	4120	4120	4130	3880	3880	3890	170
180	4040	4040	4040	3790	3790	3790	3520	3530	3530	3280	3290	3290	180
190	-	-	-	3260	3270	3270	2990	2990	3000	2750	2750	2750	190
200	-	-	-	-	-	-	2520	2520	2530	2270	2280	2280	200
210	-	-	-	-	-	-	-	-	-	1850	1860	1860	210



Asterisk (*) areas on this chart indicate ratings that are limited by strength of material or factors other than stability (tipping)

LOAD CHART

HC 110-1

with 59HI Offset Tip Boom + 9HL Jib

70,875 lb +  30,865 lb		360°												ANSI B 30.5
50' Jib length														
	130 ft			140 ft			150 ft			160 ft				
	5°	15°	25°	5°	15°	25°	5°	15°	25°	5°	15°	25°		
ft	lb	lb	lb	lb	lb	lb	lb	lb	lb	lb	lb	lb	lb	ft
37	20690*	-	-	-	-	-	-	-	-	-	-	-	-	37
40	20420*	-	-	20450*	-	-	20440*	-	-	-	-	-	-	40
50	19740*	17970*	-	19800*	17970*	-	19870*	18010*	-	19900*	17980*	-	-	50
60	19060*	17490*	16260*	19180*	17560*	16230*	19220*	17570*	16210*	19340*	17580*	16160*	-	60
70	18360*	17070*	15960*	18580*	17140*	15980*	18680*	17170*	15960*	18800*	17240*	15960*	-	70
80	17820*	16590*	15610*	17950*	16690*	15720*	18150*	16830*	15700*	18160	16880*	15700*	-	80
90	16090	16090	14680*	15830	15830	15000*	15580	15580	15300*	15320	15330	15330	-	90
100	13870	13870	13800*	13610	13620	13620	13370	13370	13370	13100	13100	13110	-	100
110	12090	12090	12100	11820	11820	11830	11580	11580	11580	11320	11320	11320	-	110
120	10620	10620	10630	10360	10360	10370	10100	10110	10110	9850	9850	9850	-	120
130	9400	9410	9410	9130	9140	9140	8890	8890	8890	8620	8620	8620	-	130
140	-	-	-	8100	8100	8100	7840	7840	7840	7580	7580	7590	-	140
150	-	-	-	-	-	-	6950	6950	6960	6680	6680	6690	-	150
160	-	-	-	-	-	-	-	-	-	5910	5910	5910	-	160
170	-	-	-	-	-	-	-	-	-	-	-	-	-	170



50' Jib length														
	170 ft			180 ft			190 ft			200 ft				
	5°	15°	25°	5°	15°	25°	5°	15°	25°	5°	15°	25°		
ft	lb	lb	lb	lb	lb	lb	lb	lb	lb	lb	lb	lb	lb	ft
50	19900*	-	-	19860*	-	-	19700*	-	-	17950*	-	-	-	50
60	19360*	17590*	15930*	19330*	17550*	-	19290*	17450*	-	16920*	15650*	-	-	60
70	18800*	17260*	15930*	18820*	17200*	15890*	18520*	17140*	15750*	15940*	14930*	13850*	-	70
80	17930	16880*	15730*	17680	16930*	15650*	17430	16510*	15460*	14930*	14160*	13360*	-	80
90	15090	15090	15090	14840	14850	14850	14600	14600	14600	14020*	13460*	12760*	-	90
100	12870	12870	12870	12610	12610	12620	12360	12370	12370	12120	12120	12120	-	100
110	11080	11080	11090	10830	10830	10830	10580	10580	10590	10330	10330	10330	-	110
120	9610	9610	9620	9350	9360	9360	9110	9110	9110	8850	8850	8860	-	120
130	8380	8380	8390	8120	8130	8130	7880	7880	7880	7620	7620	7630	-	130
140	7340	7340	7350	7080	7080	7090	6840	6840	6840	6570	6570	6570	-	140
150	6440	6440	6450	6180	6190	6190	5940	5940	5940	5680	5680	5680	-	150
160	5680	5680	5680	5410	5410	5410	5160	5160	5160	4900	4900	4910	-	160
170	4990	4990	5000	4730	4730	4740	4480	4480	4490	4220	4220	4230	-	170
180	-	-	-	4140	4140	4140	3880	3890	3890	3610	3620	3620	-	180
190	-	-	-	-	-	-	3350	3350	3360	3090	3090	3100	-	190
200	-	-	-	-	-	-	-	-	-	2610	2620	2620	-	200
210	-	-	-	-	-	-	-	-	-	-	-	-	-	210



Asterisk (*) areas on this chart indicate ratings that are limited by strength of material or factors other than stability (tipping)

LOAD CHART

HC 110-1

with 59HI Offset Tip Boom + 9HL Jib

70,875 lb +  30,865 lb		360°									ANSI B 30.5			
60' Jib length														
	150 ft			160 ft			170 ft			180 ft				
	5°	15°	25°	5°	15°	25°	5°	15°	25°	5°	15°	25°		
ft	lb	lb	lb	lb	lb	lb	lb	lb	lb	lb	lb	lb	lb	ft
43	15320*	-	-	-	-	-	-	-	-	-	-	-	-	43
50	14960*	-	-	14960*	-	-	15000*	-	-	15010*	-	-	-	50
60	14380*	12910*	-	14450*	12940*	-	14520*	12980*	-	14540*	13000*	-	-	60
70	13830*	12520*	11360*	13960*	12620*	11420*	14020*	12630*	11440*	14090*	12670*	11500*	-	70
80	13330*	12040*	11000*	13470*	12140*	11080*	13550*	12250*	11110*	13640*	12350*	11180*	-	80
90	12870*	11600*	10680*	13010*	11710*	10750*	13160*	11850*	10790*	13260*	11950*	10860*	-	90
100	12290*	11220*	10380*	12510*	11340*	10460*	12710*	11480*	10510*	12700	11590*	10590*	-	100
110	11670	10860*	10120*	11410	11000*	10190*	11180	11120*	10300*	10920	10920	10350*	-	110
120	10200	10200	9890*	9940	9940	9950	9700	9710	9710	9450	9450	9450	-	120
130	8970	8970	8970	8710	8710	8720	8470	8480	8480	8220	8220	8220	-	130
140	7930	7930	7940	7670	7670	7680	7430	7440	7440	7170	7170	7170	-	140
150	7040	7040	7050	6770	6770	6780	6530	6540	6540	6280	6280	6280	-	150
160	-	-	-	6000	6000	6000	5760	5760	5760	5500	5500	5500	-	160
170	-	-	-	-	-	-	5080	5080	5090	4820	4820	4830	-	170
180	-	-	-	-	-	-	-	-	-	4220	4230	4230	-	180



60' Jib length													
	190 ft			200 ft									
	5°	15°	25°	5°	15°	25°							
ft	lb	lb	lb	lb	lb	lb	ft						
50	15020*	-	-	-	-	-	50						
60	14560*	12990*	-	14570*	-	-	60						
70	14150*	12690*	11470*	14150*	12680*	10890*	70						
80	13690*	12390*	11250*	13750*	12370*	10890*	80						
90	13310*	12050*	10930*	13350*	12130*	10890*	90						
100	12460	11680*	10670*	12200	11760*	10730*	100						
110	10680	10680	10430*	10420	10420	10430	110						
120	9200	9200	9210	8940	8940	8940	120						
130	7970	7970	7980	7700	7710	7710	130						
140	6920	6920	6930	6660	6660	6670	140						
150	6030	6030	6040	5760	5760	5770	150						
160	5250	5250	5260	4990	4990	5000	160						
170	4570	4570	4580	4300	4300	4310	170						
180	3970	3980	3980	3700	3710	3710	180						
190	3440	3440	3450	3180	3180	3190	190						
200	-	-	-	2700	2710	2710	200						
210	-	-	-	-	-	-	210						



Asterisk (*) areas on this chart indicate ratings that are limited by strength of material or factors other than stability (tipping)

LOAD CHART

HC 110-1

with 59HI Offset Tip Boom + 9HL Jib

70,875 lb +  30,865 lb		360°									ANSI B 30.5
70' Jib length											
	180 ft			190 ft			200 ft				
	5°	15°	25°	5°	15°	25°	5°	15°	25°		
ft	lb	lb	lb	lb	lb	lb	lb	lb	lb	ft	
50	11880*	-	-	-	-	-	-	-	-	50	
60	11450*	-	-	11470*	-	-	11520*	-	-	60	
70	11010*	9570*	-	11060*	9650*	-	11110*	9690*	-	70	
80	10550*	9180*	8190*	10670*	9260*	8220*	10720*	9340*	8250*	80	
90	10080*	8850*	7930*	10200*	8910*	7990*	10310*	9000*	8020*	90	
100	9630*	8540*	7690*	9780*	8600*	7740*	9890*	8690*	7790*	100	
110	9240*	8240*	7500*	9340*	8310*	7530*	9510*	8400*	7570*	110	
120	8850*	7960*	7300*	9000*	8050*	7360*	9020	8150*	7410*	120	
130	8290	7750*	7130*	8040	7820*	7180*	7780	7780	7210*	130	
140	7240	7240	6990*	6990	6990	7000	6740	6740	6740	140	
150	6350	6350	6360	6100	6100	6110	5830	5840	5840	150	
160	5570	5570	5580	5320	5320	5330	5060	5070	5070	160	
170	4890	4890	4900	4640	4640	4650	4370	4380	4380	170	
180	4290	4300	4300	4040	4050	4050	3780	3780	3780	180	
190	-	-	-	3510	3510	3520	3250	3250	3260	190	
200	-	-	-	-	-	-	2770	2780	2780	200	
210	-	-	-	-	-	-	-	-	-	210	

80' Jib length											
	200 ft										
	5°	15°	25°								
ft	lb	lb	lb	ft							
56	9580*	-	-	56							
60	9420*	-	-	60							
70	8960*	7550*	-	70							
80	8530*	7220*	-	80							
90	8100*	6940*	6090*	90							
100	7740*	6670*	5910*	100							
110	7390*	6430*	5740*	110							
120	7080*	6200*	5570*	120							
130	6780*	6010*	5410*	130							
140	6520*	5820*	5290*	140							
150	5910	5640*	5160*	150							
160	5130	5130	5040*	160							
170	4450	4450	4460	170							
180	3850	3850	3860	180							
190	3310	3310	3320	190							
200	2830	2840	2840	200							
210	-	-	-	210							

Asterisk (*) areas on this chart indicate ratings that are limited by strength of material or factors other than stability (tipping)

NOTES TO LIFTING CAPACITY

HC 110-1

Main Boom Chart Information

59HI Offset Tip Boom

Boom length (ft)	25' 59HI Inner	10' 59H Center	20' 59H Center	40' 59H Center	25' 59HI Outer
100	1	1	0	1	1
110	1	0	1	1	1
120	1	1	1	1	1
130	1	0	0	2	1
140	1	1	0	2	1
150	1	0	1	2	1
160	1	1	1	2	1
170	1	0	0	3	1
180	1	1	0	3	1
190	1	0	1	3	1
200	1	1	1	3	1
210	1	0	0	4	1

9HL Jib

Jib length (ft)	20' Inner	10' Center	20' Center	20' Outer
40	1	0	0	1
50	1	1	0	1
60	1	0	1	1
70	1	1	1	1
80	1	0	2	1

Hydraulic Crawler Crane

Maximum lifting capacity

110 tons (100 mt) @ 13 ft radius. Max. load moment 431 tm.

Boom systems

59HI Tubular Chord Boom, pin connected – with 4 Sheave Tip

- 230 ft maximum boom length.
- 280 ft maximum boom and jib combination length.
- 25 ft (7.6 m) inner and 25 ft (7.6 m) outer and 10 ft / 20 ft / 40 ft available inserts provide boom compositions in 10 ft (3 m) increments from 50 ft (15.2 m) to 230 ft (70 m).

Robust engine

- Cummins Model QSB 6.7 Turbocharged, after cooler, diesel engine Tier4, 4 cycle, 6 cylinders, direct fuel injection, 409 cubic inch displacement, 6.7 liters, 249 BHP @ 2000 rpm, 105 gallons fuel tank capacity.

Environmental operator's cab

- Designed to provide excellent viewing range and quiet, comfortable operation.
- 37 inch (0.94 m) wide cab has wide curved windows on both top and bottom.
- Easy-to-operate modular and ergonomically designed controls reduce operator fatigue and increase productivity.
- Load Moment Indicator with interactive screen. Operator can select from three display modes: loaded condition diagram, rated lifting curve or rated lifting load table.
- Adjustable operator's seat, radio, air conditioner, overhead window, sun visor, overhead and front wipers and drum rotation indicators are standard.

Heavy duty carbody and crawlers

- Fabricated steel carbody is deep box constructed with square axles for the crawler side frames. Precision machined top supports anti-friction swing bearing and multiple pass hydraulic swivel joint.
- Crawlers have high alloy steel tumbler yokes and rigid fabricated structures with sealed rollers.
- 36" (914 mm) crawler shoes.
- Travel mechanism is contained within shoe width.
- Side frames extended or retracted by cylinders inside the carbody.
- Two travel speed settings – 0.60 / 0.93 mph (0.96 / 1.5 km/h).
- 30 % (17°) gradeability.

Powerful, high-speed hoist system

- Independent main and auxiliary load hoisting drums. 2 auxiliary drums are grooved for 26 mm diameter rope. Max line speed is 566 fpm (172 m/min), max single line pull is 42,108 lb (19 100 kg). Rated line pull dependent on rope type*.
- Freefall on main and auxiliary drums.
- Each drum has power up/down and freefall. Load hoists are further controllable in stepless mode.
- Ample work space in front of the drums allows easy access for cable installation and maintenance.
- External contracting brake.
- Internal wet disc brake /clutch.
- 2.4 rpm swing speed.

* Maximum rated single line pull of 30,310 lb standard rope / 29,670 lb rotation resistant rope)

High capacity, dependable hydraulic system

- Open circuit system has 2 variable displacement piston pumps with system capacity of 183 gpm (692 lpm).
- Hydraulic reservoir with 79 gallons (300 l) capacity and 10 micron filtration.
- Component working range is between -4 and 203° F (-20 and 95° C).

Five piece removable upper counterweight

- Five piece pin connected upper counterweight can be assembled or disassembled easily within minutes.
- Hydraulic counterweight removal system is standard and makes the HC 110 one of the most transportable cranes in its class.
- Moves on six trucks with full boom and #9HL jib. With shipping width of 12 ft and shipping height of 10 ft 9 in and shipping weight of 98,600 lb, the basic HC 110 will transport on a standard lowboy trailer.

Options include

- Third drum
- Hydraulic power take off
- Jib and jib inserts
- Single sheave extension
- Tagline winder
- Cold weather package
- Anemometer
- Boom lights

LOAD PLAN FOR HC 110-1

HC 110-1

with 200' Main Boom + 70' 9HL Jib

LOAD 1 – Step Deck

Carbody Counterweights.....	30,864 lb
40' Boom Center.....	2,670 lb
75T Load Block.....	1,100 lb
IHI Blue Crate.....	1,000 lb
TOTAL.....	35,634 lb

LOAD 2 – Step Deck Load Leveler Required

40' Boom Center.....	2,670 lb
15T Overhaul Ball.....	650 lb
25T Load Block.....	500 lb
Pendant 1.375" x 23'4" Closed.....	150 lb
Pendant 20'.....	300 lb
Pendant 1.38" x 40'.....	500 lb
Sling.....	200 lb
L.H. Counterweight.....	23,370 lb
TOTAL.....	28,340 lb

LOAD 3 – Step Deck Load Leveler Required

Boom Outer offset with 3 sheaves.....	4,200 lb
Boom Center 20' 59HI.....	1,975 lb
R.H. Counterweight.....	23,370 lb
TOTAL.....	29,545 lb

LOAD 4 – Step Deck Load Leveler Required

59HI Single Sheave Extension.....	500 lb
Wire Rope 26 mm x 275 m.....	1,900 lb
Wire Rope 26 mm x 155 m.....	2,000 lb
Base Counterweight.....	22,050 lb
10' Boom Center.....	1,500 lb
TOTAL.....	27,950 lb

LOAD 5 – Flat bed

40' Boom Center.....	2,670 lb
9HL Jib Inner.....	1,000 lb
9HL Jib Outer.....	800 lb
9HL 20' Center.....	300 lb
9HL 10' Center.....	150 lb
Jib Spreader bar / Security device.....	120 lb
TOTAL.....	5,040 lb

LOAD 6 – RGN (removable gooseneck)

HC 110-1 Base Unit.....	98,600 lb
Includes boom inner, sideframes, boom hoist rope, counterweight removal system, boom stops	

Lined area for notes.

A large rectangular area with horizontal lines, intended for taking notes. The lines are evenly spaced and cover the majority of the page's width and height.

Effective Date: July 2016.

Product specifications and prices are subject to change without notice or obligation. The photographs and/or drawings in this document are for illustrative purposes only. Refer to the appropriate Operator's Manual for instructions on the proper use of this equipment. Failure to follow the appropriate Operator's Manual when using our equipment or to otherwise act irresponsibly may result in serious injury or death. The only warranty applicable to our equipment is the standard written warranty applicable to the particular product and sale and Terex makes no other warranty, express or implied. Products and services listed may be trademarks, service marks or trade-names of Terex Corporation and/or its subsidiaries in the USA and other countries. All rights are reserved. Terex® is a registered trademark of Terex Corporation in the USA and many other countries.

Copyright Terex Cranes 2016

Terex Cranes, Global Marketing, Dinglerstraße 24, 66482 Zweibrücken, Germany
Tel. +49 (0) 6332 830, Email: info.cranes@terex.com, www.terexcranes.com



www.terex.com/cranes

Brochure Reference: TC-DS-I-E-HC 110-1-07/16



TEREX®

WORKS FOR YOU.™