

# F 45A.22

## use and maintenance

FROM SERIAL NUMBER \*6676\*

### INDEX

1	INTRODUCTION
2	CLASSIFICATION OF THE CRANE MODEL
2.1	Generality
2.2	Hydraulic jibs (not available)
2.3	Technical data
3	CAPACITY PLATES
3.1	Generality
3.1.1	Capacity plates with lifting moment limiting device
4	HYDRAULIC SCHEMATICS (version with lifting moment limiting device)
5	ELECTRIC SCHEMATICS
6	SAFETY NORMS
7	WARNING AND INSTRUCTIONS
7.1	Generality
7.2	Before operating
7.3	During operation
7.4	At the end of the operation (Prior to driving the vehicle)
7.5	Residual risks
8	IDENTIFICATION OF THE CRANE MODEL
8.1	Generality
8.2	Crane mark
9	CRANE NOMENCLATURE
9.1	Version with ground controls for crane and outriggers
10	NOMENCLATURE OF THE SAFETY AND PROTECTION DEVICES
10.1	Version with ground controls for crane and outriggers
11	SUPPLEMENTARY BEAMS
11.1	Generality
11.2	Identification of the supplementary beams
12	TILTABLE OUTRIGGER RAMS
12.1	Manually tiltable outrigger rams
13	MANOEUVRES AND CONTROLS TO STABILIZE THE VEHICLE
13.1	Generality

- 13.2 Standard extendable outrigger supports or, on request extra-extendable outrigger supports
- 13.3 Super extra-extendable outrigger supports (if fitted)
- 14 CONTROLS TO OPERATE THE CRANE
- 14.1 Generality
- 14.2 Manoeuvres to unfold the crane into a working condition
- 14.3 Manoeuvres to fold the crane into the rest condition
- 14.4 Manoeuvres to unfold the crane "C" into a working condition (only for the crane version "C")
- 14.5 Manoeuvres to fold the crane "C" into the rest condition (only for the crane version "C")
- 14.6 Indicator of inner boom horizontal position (optional)
- 14.7 Stand-up control station (optional)
- 15 MANOEUVRES OF THE CRANE LOADS (version with load limiting device)  
(not available)
- 16 MANOEUVRES OF THE CRANE LOADS (version with lifting moment limiting device)
- 16.1 Generality
- 16.2 Lifting moment limiting device "ELECTRONIC"
- 16.3 Control panels
- 16.4 Load handling
- 16.5 Lifting moment limiting device for two working sectors
- 16.6 Rotation limiting device
- 16.7 In the case of the appearance of the signal "ALARM" on the display of the control panel or of the radio remote control or in case of an electrical failure
- 16.7.1 Diagnostic (Alarms/Input/Output) LME vers. 4-5 UC 01-7
- 16.7.2 Temporary OVERRIDE-Reactivation for the crane functions with standard distributor
- 16.7.3 OVERRIDE-Reactivation lever for the crane functions (with Danfoss distributor)
- 16.8 XP device (if fitted, see the Use and Maintenance booklet)
- 16.8.1 Activation and instructions for use of the XP/V device  
(if fitted, see the Use and Maintenance booklet)
- 17 USE OF IMPLEMENTS
- 17.1 Generality
- 17.2 Hydraulic connections for implements - supplementary hoses
- 17.3 Oil cooler (heat exchanger)
- 18 MANUAL EXTENSIONS
- 18.1 Generality
- 18.2 Lifting moment limiting device "ELECTRONIC" for the manual extensions  
(valid starting from the version 3.0 of the software)
- 19 CONTROLS TO OPERATE THE HYDRAULIC IMPLEMENTS OF THE CRANE
- 20 HYDRAULIC JIBS (not available)
- 21 WINCH (if fitted)
- 21.1 Generality (version with lifting moment limiting device)
- 21.2 Winch for crane
- 21.2.1 Winches equipped with a mechanical stroke end device
- 22 MAINTENANCE INSTRUCTIONS
- 22.1 Generality
- 22.2 Timer
- 22.3 After every 8 working hours or at the end of every working day
- 22.4 After every 40 working hours or atfter every working week
- 22.5 After every 100 working hours or more frequently in case of more intensive utilisation
- 22.6 After every 500 working hours or after every 6 working months
- 22.7 After every 1000 working hours or after every working year
- 22.8 Complete overhaul of the crane is required when 10.000 working hours or 10 years' life are reached
- 22.9 Instructions for the dismantlement and the demolition of a FASSI crane
- 23 TABLE OF HYDRAULIC OIL AND LUBRICANTS CHARACTERISTICS
- 24 POSSIBLE FAULTS
- 24.1 Generality
- 24.2 Only operations which can be carried out by the user
- 24.3 Operations to be carried out only by a service center
- 25 INSTRUCTION AND WARNING PLATES

## use and maintenance ORIGINAL INSTRUCTIONS

**THANK YOU FOR SELECTING ONE OF FASSI CRANES.**

This crane is the result of **FASSI** philosophy: ongoing research, rigorous testing, data verification, and analysis of performances.

Many years of experience has allowed us to grant you the maximum safety of operation together with the optimization of machine performances.

All this represents the core of **FASSI quality system**.

**FASSI quality system is in conformity with  
UNI EN ISO 9001:2000 (ISO 9001:2000)**

**FASSI cranes conform with the European Norm EN12999**

The fitment of the crane on the vehicle must be carried out in accordance with the instructions given by **FASSI** in the manual for hydraulic crane fitting and the relevant chassis manufacturers directives.

The Manufacturer declines all responsibility and guarantee if the fitting is entrusted to workshops without sufficient technical capability to carry out the work in conformity.

Be sure that the unit has been installed, inspected and tested in accordance with the local legal requirements.

As well as the principal safety norms, this manual contains a description of the crane and the instructions for use and maintenance.

The following instructions refer to mobile cranes in general and must be integrated with the manual for use supplied by the centre responsible for the crane fitting on truck, vehicle or other type of structure.

**READ THIS MANUAL CAREFULLY** prior to use or any maintenance. A few minutes spent now could save time and labour later.

Always conform to the safety norms and the instructions for use and maintenance contained in the present manual in order to guarantee a long life to the crane.

### NOTE

The original version of the present manual is in italian.

**The spare parts catalogue for the crane can be viewed in the Internet site: [www.fassicat.com](http://www.fassicat.com)**



## 2 CLASSIFICATION OF THE CRANE MODEL

### 2.1 Generality

The design of this crane has been carried out in respect of **DIN 15018** norms, fatigue test classification **H1B3**.

The crane can operate, intermittently, with lifting devices other than the hook.

The dimensions and the capacity of the implements must be proportioned with crane performances.

### 2.3 Technical data

#### F 45A.22

Lifting capacity	Standard reach	Hydraulic extension	Rotation arc	Rotation torque	Working pressure	Pump capacity	Oil tank capacity	Crane weight	Max. working pressure on the outrigger (Φ 170)
<b>4,15 tm</b> 40,70 kNm	<b>6,45 m</b>	<b>2,70 m</b>	<b>370°</b>	<b>0,76 tm</b> 7,45 kNm	<b>24 MPa</b>	<b>16 l/min</b>	<b>33 l</b>	<b>638 kg</b>	<b>24,9 daN/cm<sup>2</sup></b>

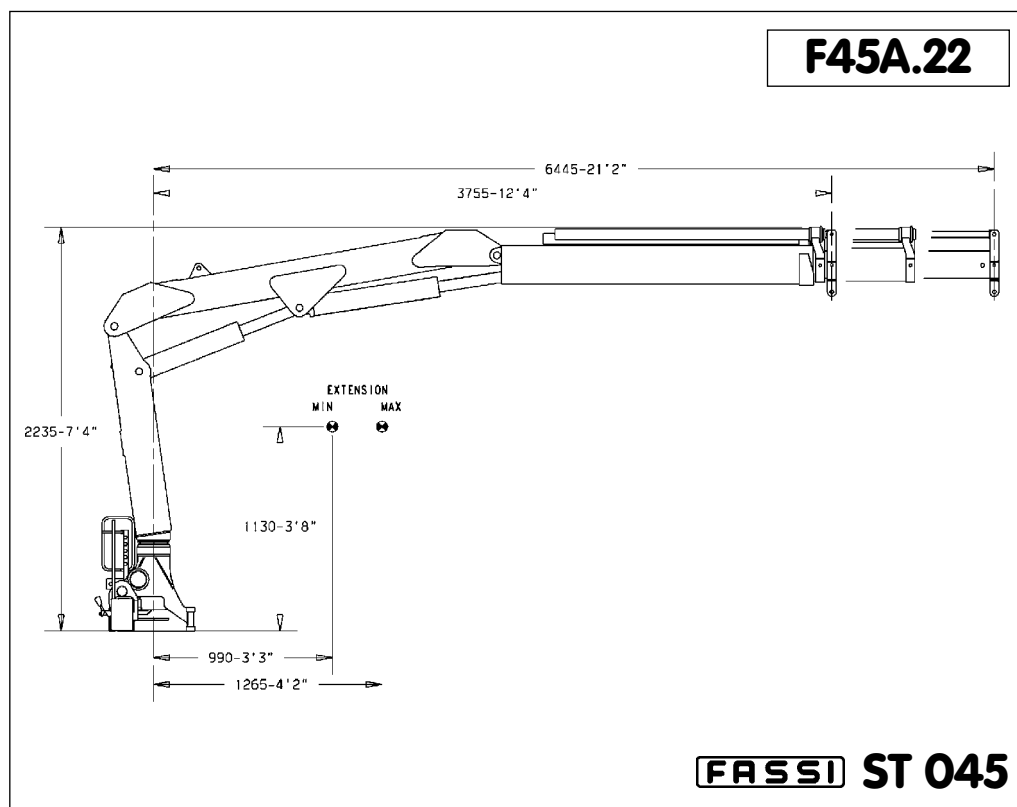

**FASSI ST 045**

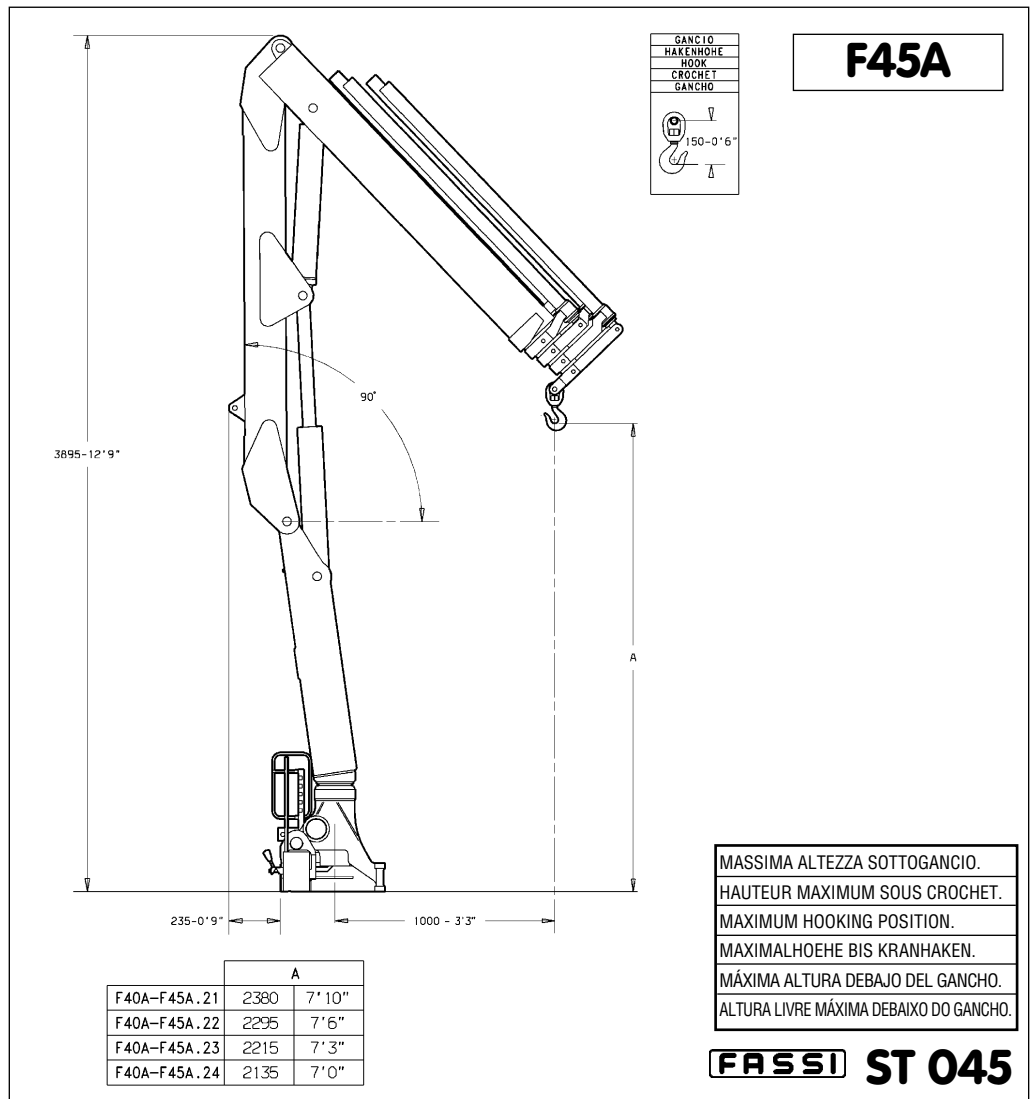
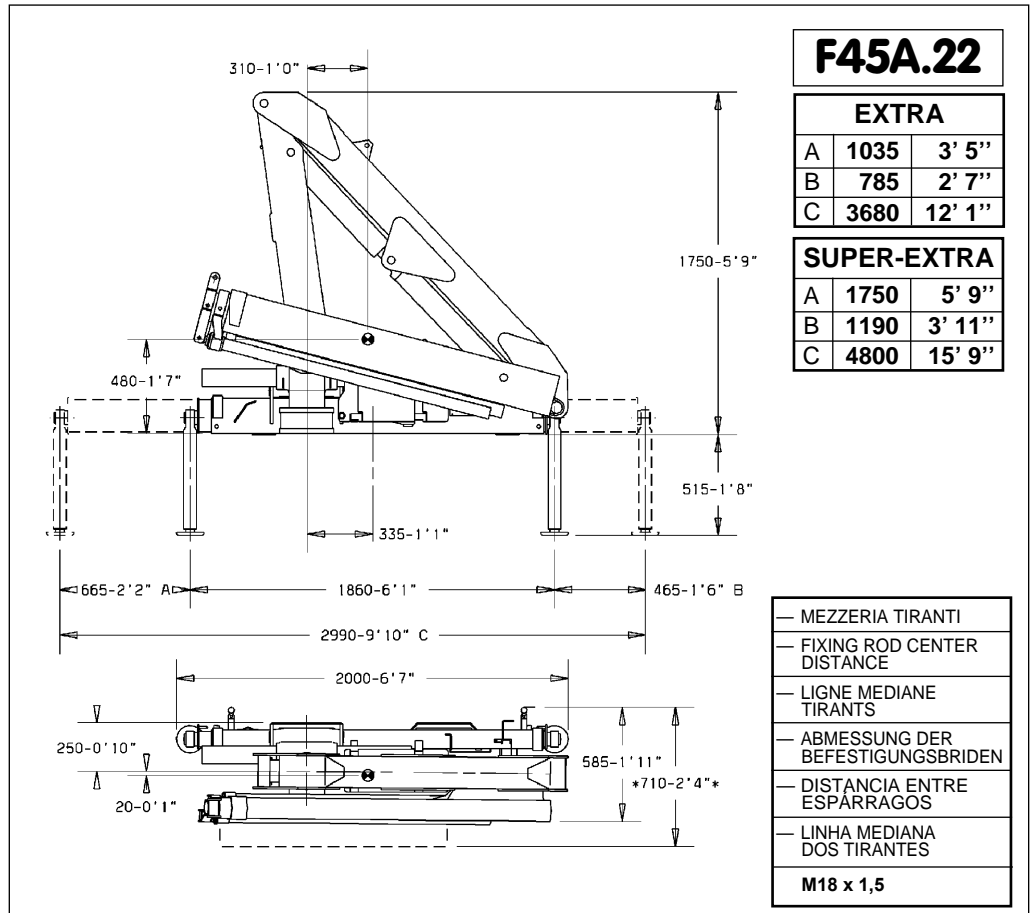

**FASSI**

3.1 Generality

The represented plates refer to the nominal design capacities.

(!) WARNING (!)

If the capacities are downgraded or partially reduced (e.g. sector in front of vehicle cab) capacity plates must be applied in line with the final test figures.

3.1-1 Capacity plates with lifting moment limiting device

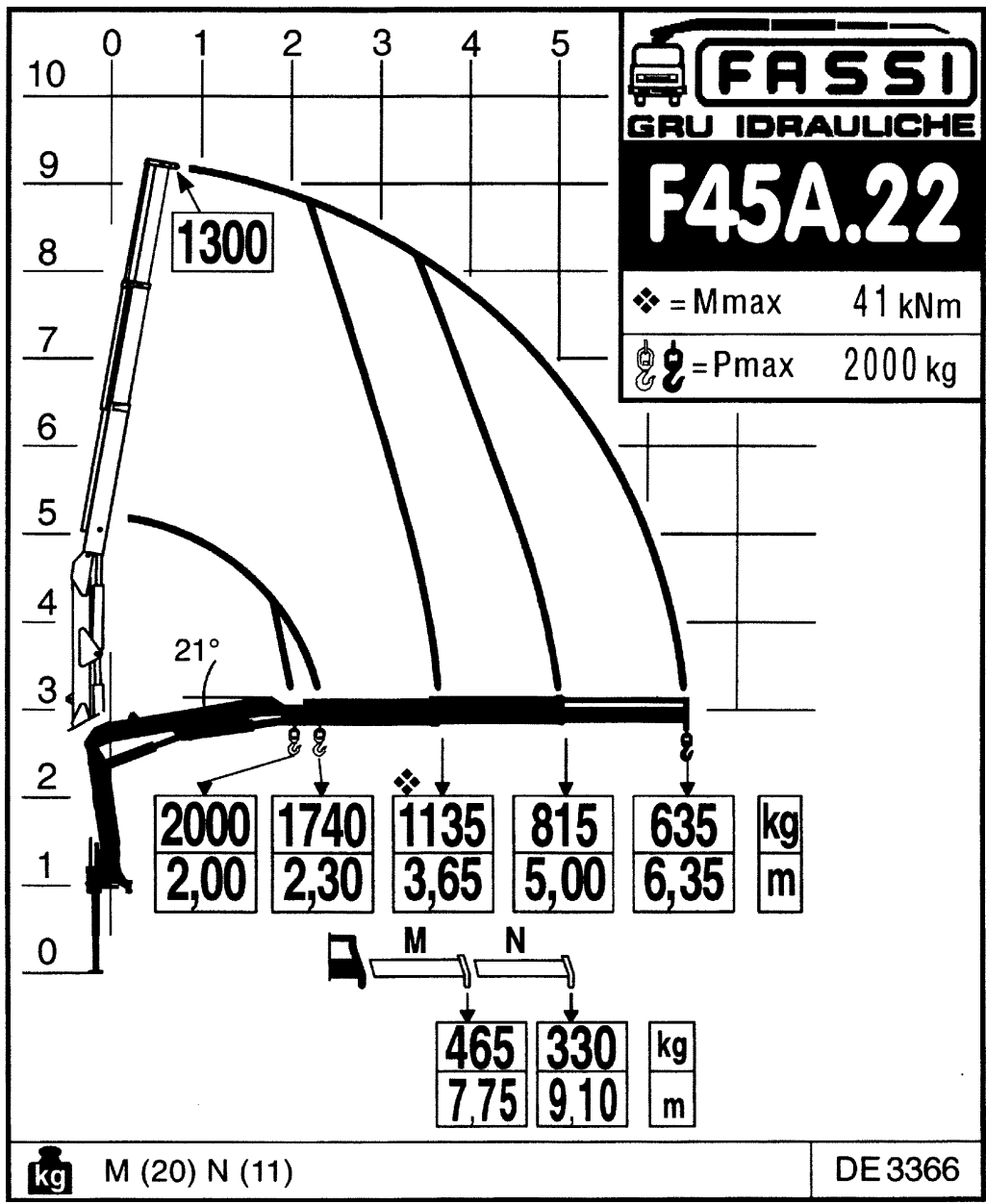

3.1-1 Capacity plates with lifting moment limiting device

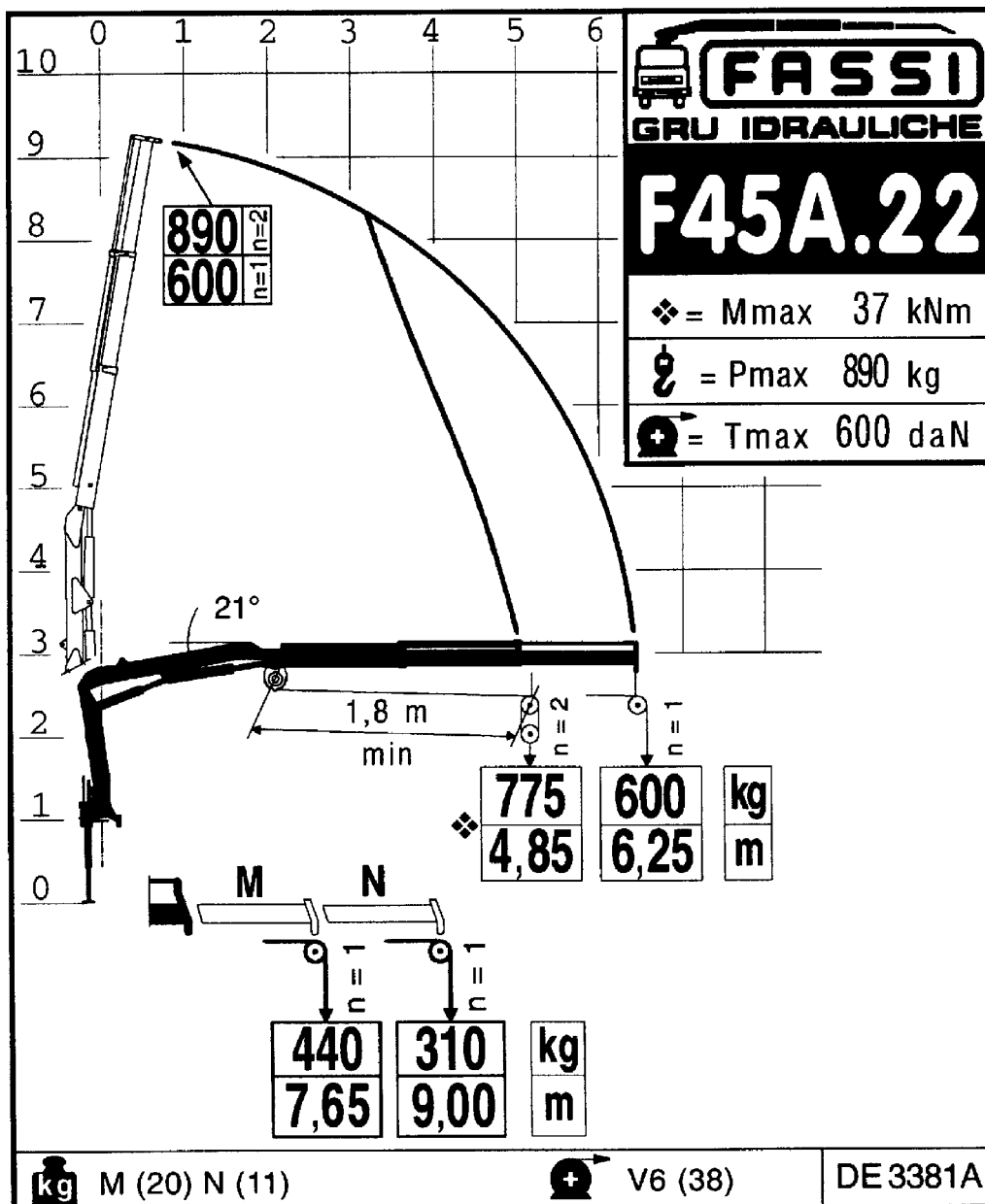



# 4 HYDRAULIC SCHEMATICS

Hydraulic schematic for crane - Walvoil distributor - "electronic" lifting moment limiting device - ground controls - from serial number 6676

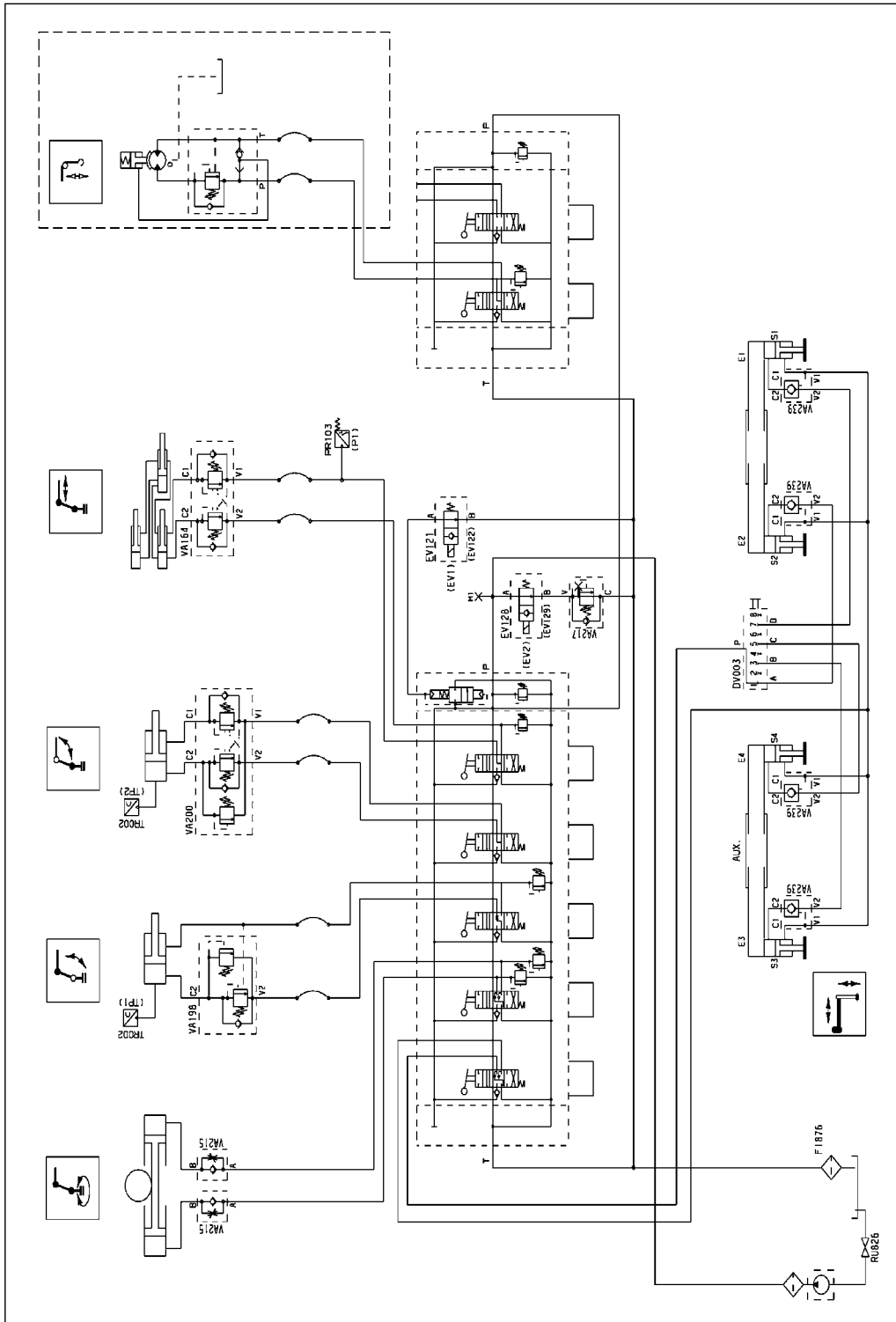

CODE DESCRIPTION

DV003	DEVIATOR	TR002	PRESSURE TRANSDUCER
EV121	ELECTROVALVE	VA164	DOUBLE EFFECT BLOCK VALVE
EV128	ELECTROVALVE	VA198	SIMPLE EFFECT BLOCK VALVE
F1876	FILTER	VA200	DOUBLE EFFECT BLOCK VALVE
M1	GAUGE QUICK CONNECTION	VA215	OIL FLOW CHECK VALVE
M2	GAUGE QUICK CONNECTION	VA217	SEQUENCE VALVE
PR103	PRESSURE SWITCH	VA239	SIMPLE EFFECT BLOCK VALVE
RU826	FAUCET		

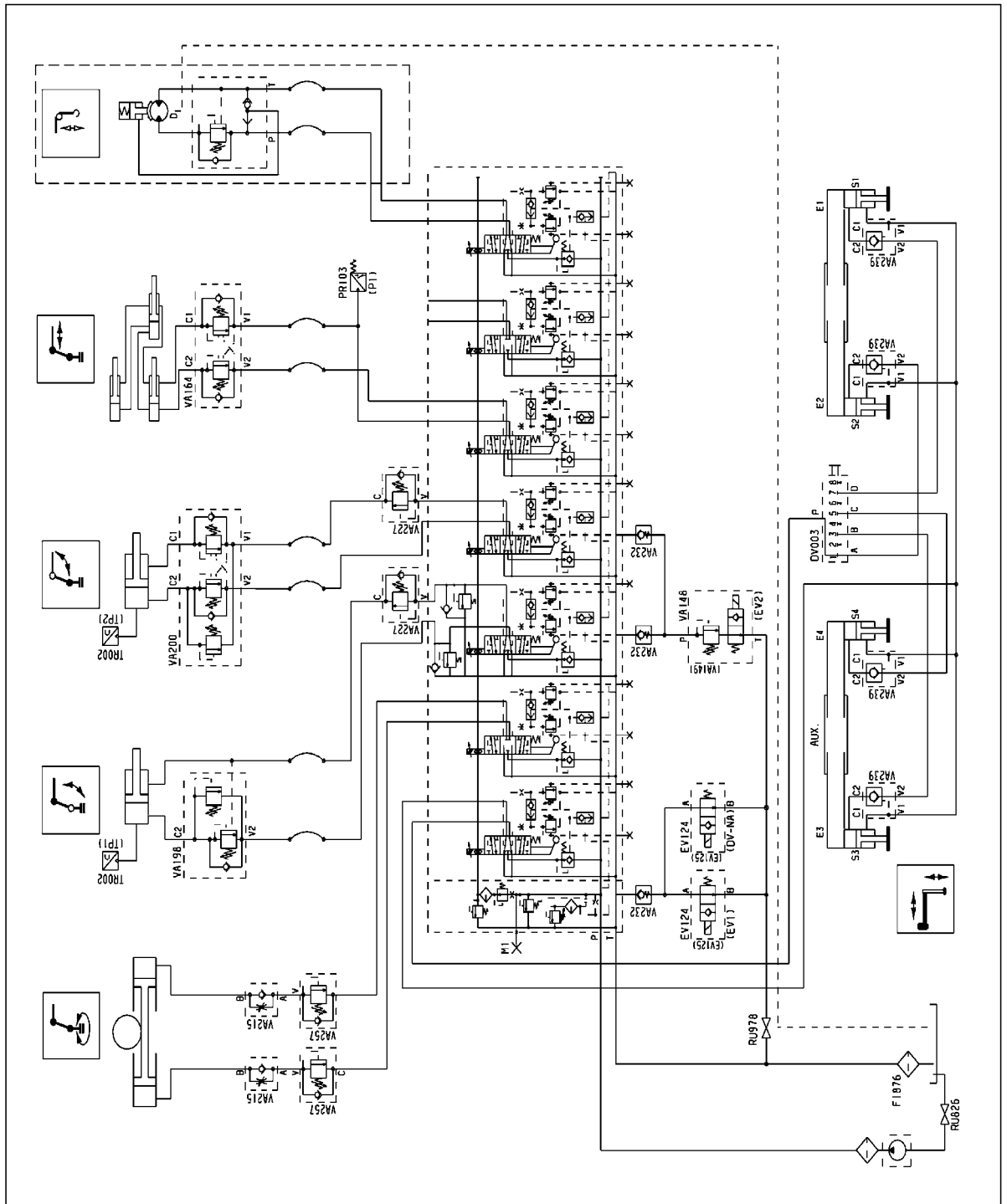

CODE DESCRIPTION

DV003	DEVIATOR	VA164	DOUBLE EFFECT BLOCK VALVE
EV124	ELECTROVALVE	VA148	ELECTRIC MAIN WITH BY PASS VALVE
F1776	FILTER	VA200	DOUBLE EFFECT BLOCK VALVE
F1876	FILTER	VA198	SIMPLE EFFECT BLOCK VALVE
M1/M2	GAUGE QUICK CONNECTION	VA215	OIL FLOW CHECK VALVE
PR103	PRESSURE SWITCH	VA227	SEQUENCE VALVE
RU826	FAUCET	VA232	UNIDIRECTIONAL VALVE
RU978	FAUCET	VA239	SIMPLE EFFECT BLOCK VALVE
TR002	PRESSURE TRANSDUCER	VA257	SEQUENCE VALVE

Electric schematic for crane

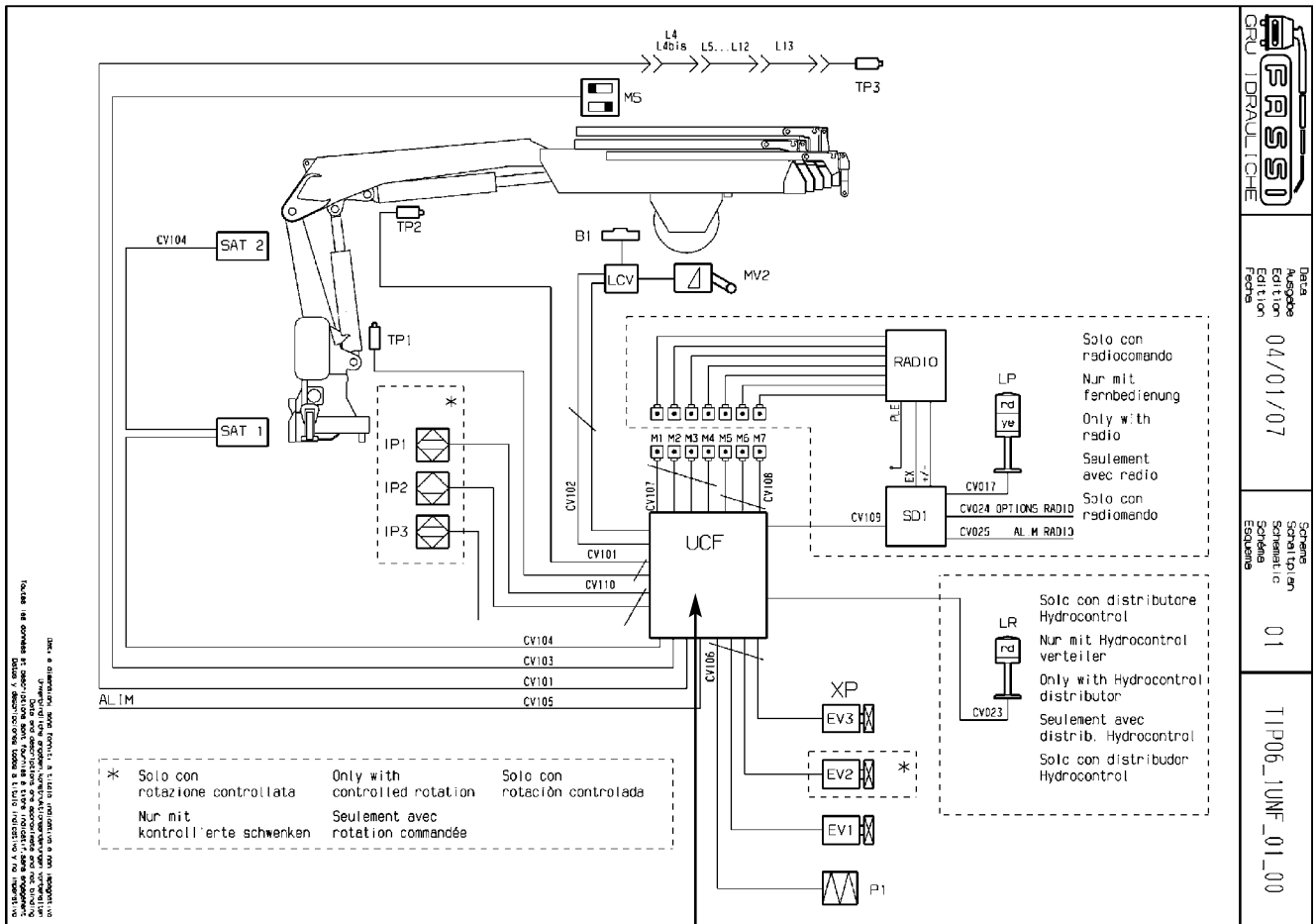

	Date Ausgabe Edition Editio Fecha	04/01/07
	Schema Schematic Schéma Esquema	01

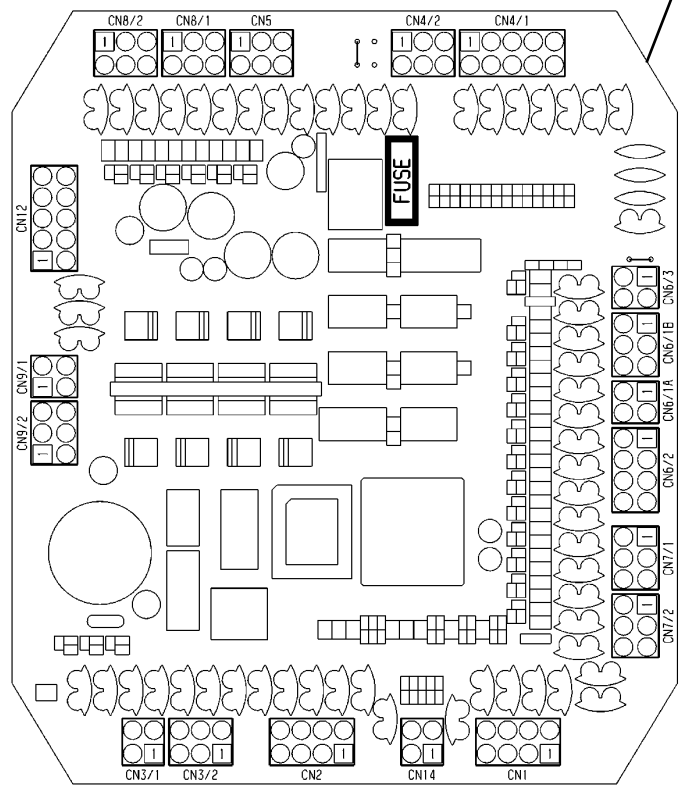

N°	DESCRIPTION
ALIM	ELECTRICAL FEED CABLE MAIN CONTROL PANEL
EV1	ELECTROVALVE FOR CRANE BLOCK
EV2	ELECTROVALVE FOR LIFTING MOMENT LIMITING DEVICE OF THE TWO WORKING ZONES
EV3	XP ELECTROVALVE
LP	FLASHING
IP1/2/3	PROXIMITY MICROSWITCH FOR ROTATION CONTROL
LCV	WINCH LOAD LIMITING DEVICE
LR	ACTIVATION OF OVERLOAD BLOCK RED WARNING LIGHT
M1	MICROSWITCH ON THE DISTRIBUTOR (ROTATION)
M2	MICROSWITCH ON THE DISTRIBUTOR (INNER BOOM)
M3	MICROSWITCH ON THE DISTRIBUTOR (OUTER BOOM)
M4	MICROSWITCH ON THE DISTRIBUTOR (CRANE EXTENSION BOOMS)
M5	MICROSWITCH ON THE DISTRIBUTOR (JIB BOOM)
M6	MICROSWITCH ON THE DISTRIBUTOR (JIB EXTENSION BOOMS)
M7	MICROSWITCH ON THE DISTRIBUTOR (WINCH)
MS	MERCURY LEVEL SENSOR ON THE OUTER BOOM
MV2	DRUM MICROSWITCH WINCH
P1	PRESSURE SWITCH FOR THE RE-ENTRY OF THE EXTENSION BOOMS
UCF	MAIN CONTROL PANEL (FX000)
S1/2/3/...	CONNECTORS
SAT1	DOUBLE CONTROL SIDE SATELLITE
SAT2	SATELLITE FOR 3° CONTROL STATION
SD1	SHUNT BOX 1
TP1	PRESSURE TRANSDUCER FOR INNER RAM
TP2	PRESSURE TRANSDUCER FOR OUTER RAM
TP3	PRESSURE TRANSDUCER FOR THE JIB RAM



Strictly conform to the norms reported by the plates DE2499B (fig. 1) or DE4236 (fig. 1a) placed next to the controls, in order to avoid possible accidents while operating the crane.

Only authorized persons are allowed to operate the crane.

The crane must be used on firm, level ground.

Check that the vehicle hand brake is on and that the wheels are chocked.

Before every operation make sure that:

- no-one is within the working area of the crane;
- the safety devices are in place and operative;
- the minimum safe working distances from power lines are observed;
- the load is correctly slung and hooked.

Stabilize the vehicle by the outrigger rams, making sure that:

- the lateral supports are fully extended;
- the wheels are in contact with the ground and the suspension is not completely unloaded.

Use the crane in accordance with the use and maintenance manual, making sure that:

- the load and radius are within the maximum limits shown on the crane capacity plate;
- the crane is used progressively avoiding sudden load movements
- swinging or dragging of the load is avoided;
- the load is lifted before rotating.

When using implements protect the crane working area with a barrier.

The vehicle/crane are not left unless the power take off is disengaged and the load is on the ground.

Before driving the vehicle make sure that the outriggers are fully retracted and re-entered, the safety taps closed and the crane is in folded position.

## VERTICAL VERSION

fig. 1



**FASSI**  
GRU IDRAULICHE

FASSI GRU IDRAULICHE SpA  
24021 ALBINO (BG) ITALIA - Via dei Carmelitani, 2  
Tel. + 39 35 77.64.00 - Fax + 39 35 75.50.20

DE2499B

### INSTRUCTIONS FOR SAFE USE OF THE CRANE

- 1 Only authorized persons are permitted to operate the crane.
- 2 The crane must be used on firm, level ground.
- 3 Check that the vehicle hand brake is on and that the wheels are chocked.
- 4 Before operation make sure that:
  - no-one is within the working area of the crane;
  - the safety devices are in place and operative;
  - the minimum safe working distances from power lines are observed;
  - the load is correctly slung and hooked.
- 5 Stabilize the vehicle with the outriggers, making sure that:
  - the lateral supports are fully extended;
  - the wheels are in contact with the ground and the suspension is not completely unloaded.
- 6 Use the crane in accordance with the use and maintenance manual, making sure that:
  - the load and radius are within the maximum limits shown on the crane capacity plate;
  - the crane is used progressively avoiding sudden load movements;
  - swinging or dragging of the load is avoided;
  - the load is lifted before rotating.
- 7 When using implements protect the working area with a barrier.
- 8 The vehicle/crane are not left unless the power take off is disengaged and the load is on the ground.
- 9 Before driving the vehicle ensure that the outriggers are fully retracted and re-entered, the safety taps closed and the crane is in the folded position.

## HORIZONTAL VERSION

fig. 1a



**FASSI**  
GRU IDRAULICHE

FASSI GRU IDRAULICHE SpA  
24021 ALBINO (BG) ITALIA - Via dei Carmelitani, 2  
Tel. + 39 35 77.64.00 - Fax + 39 35 75.50.20

DE4236

### INSTRUCTIONS FOR SAFE USE OF THE CRANE

- 1 Only authorized persons are permitted to operate the crane.
- 2 The crane must be used on firm, level ground.
- 3 Check that the vehicle hand brake is on and that the wheels are chocked.
- 4 Before operation make sure that:
  - no-one is within the working area of the crane;
  - the safety devices are in place and operative;
  - the minimum safe working distances from power lines are observed;
  - the load is correctly slung and hooked.
- 5 Stabilize the vehicle with the outriggers, making sure that:
  - the lateral supports are fully extended;
  - the wheels are in contact with the ground and the suspension is not completely unloaded.
- 6 Use the crane in accordance with the use and maintenance manual, making sure that:
  - the load and radius are within the maximum limits shown on the crane capacity plate;
  - the crane is used progressively avoiding sudden load movements;
  - swinging or dragging of the load is avoided;
  - the load is lifted before rotating.
- 7 When using implements protect the working area with a barrier.
- 8 The vehicle/crane are not left unless the power take off is disengaged and the load is on the ground.
- 9 Before driving the vehicle ensure that the outriggers are fully retracted and re-entered, the safety taps closed and the crane is in the folded position.



## 7 WARNING AND INSTRUCTIONS

### 7.1 Generality

The use of the crane is reserved to authorized personnel, instructed in advance, who has to conform to the safety norms and instructions contained in the use manual supplied with the crane. (See norms ISO 9926-1)

It is absolutely prohibited to walk or stop under a suspended load

It is prohibited for unauthorized persons to be within the working area.

Under no circumstances interfere with the safety and protection devices.

Warning plates, as well as instruction and operation plates must be replaced when no longer readable or missing. See Paragraph 25 Instruction and warning plates.

Do not use the outriggers to raise the vehicle.

To avoid hitting bridges or tunnels check and record the overall height of your crane in the folded position or in laid position in the body or on the load. Always respect and pay proper attention to road signs placed in proximity of such obstacles.

### 7.2 Before operating

#### (!) ATTENTION (!)

**Check that protections are in their place and that all safety devices are fitted and active. (See norms ISO 9927-1)**

Keep the ladder and the control station on the top seat, clean; Normally, the seat can tilt forward.

Make sure that control stations are properly lit so as to ensure safety while operating and allow instruction plates to be visible.

Check that the working area is adequate and properly lighted for your crane.

Make sure that the hook is always free to rotate on its pin and that nothing obstructs its vertical positioning.

Check the efficiency of the hook safety catch.

Carefully inspect the condition of ropes or chains. (if present)

Make sure that the pallet fork (if present) is connected to the crane hook by means of a chain having at least **three (3)** rings.

### 7.3 During operation

Take the vehicle fumes away from the working area by fitting an extension tube of a suitable diameter and a right length to the exhaust system.

Do not run the engine in a indoor area without first making sure there is adequate ventilation.

When using the ladder to reach the control station on the top seat, avoid knocking into the controls while going up or down the ladder.

The control station on the top seat is provided with side safety guards; stay within these guards.

Make sure that no one is within the working area of the crane.

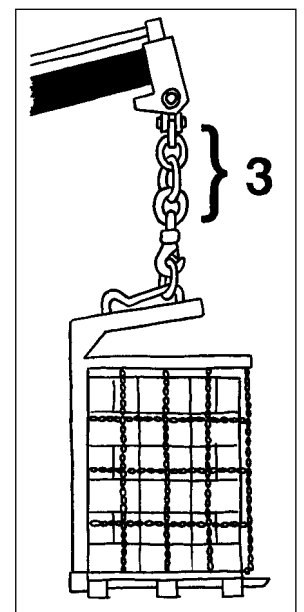
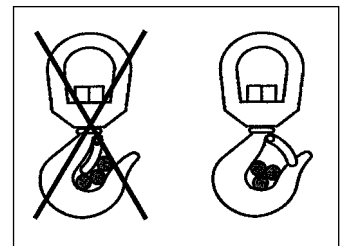
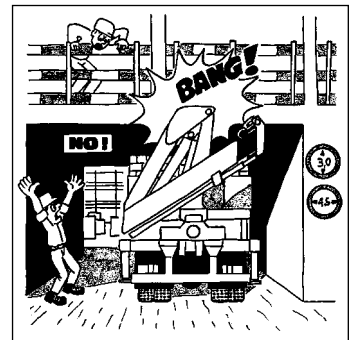
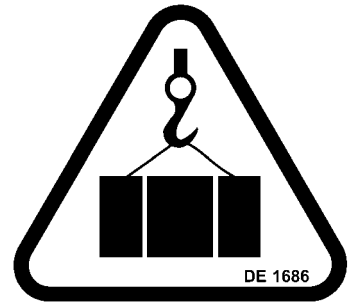

**(!) ATTENTION (!)**

Avoid swinging the load above working and transit areas; any hidden danger situation must be audibly alarmed.

Avoid all those situations which may result in crushing during vehicle stabilization, crane movement and load handling.

(In conformity with EN 349 standard the minimum safe working distances to avoid crushing parts of the body)

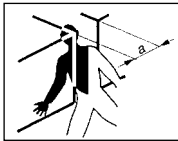
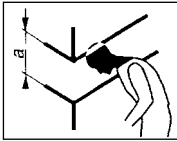
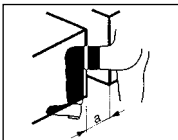
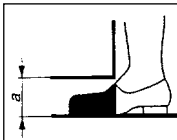
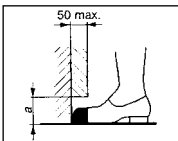
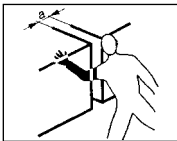
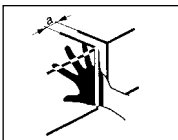
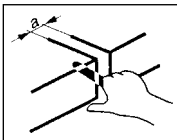
Parts of the Body	Minimum safe working distance mm	Figure	Parts of the Body	Minimum safe working distance mm	Figure
Body	500		Head	300	
Leg	180		Foot	120	
Toes	50		Arm	120	
Hand Wrist Fist	100		Finger	25	

The table indicates the minimum safety working distances concerning the various parts of the body.

The figures illustrate circumstances which may turn out to be dangerous if you fail to respect the minimum safe distances and if it is impossible to introduce larger parts of the body.

**(!) ATTENTION (!)**

For designated areas as: outrigger running towards rest position, leaning and folding points of the booms in rest position, control platform and swining column, top seat and running inner boom, where no carter is possible to be placed, please observe the shear and trapping hazard stickers nearly placed.

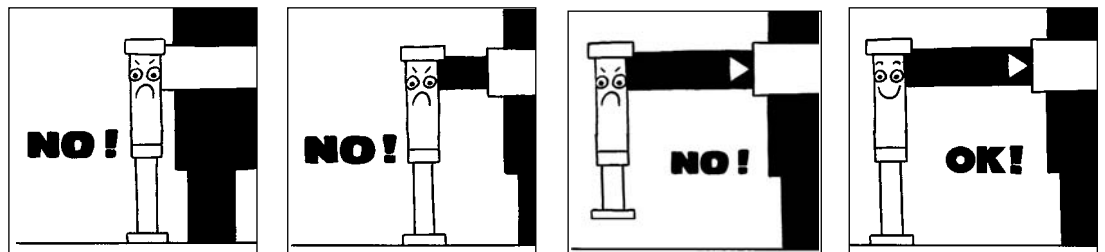

**(!) ATTENTION (!)**

Failure to respect the minimum safe distances may result in a safety hazard and a deadly risk.

Remember that the stability of the unit (crane-vehicle) is only guaranteed by the complete lateral extension of the outriggers and by the observance of the capacity plates.

Stabilize the vehicle on a horizontal plane with a maximum tolerance of 1,5 degrees. Make sure that the outrigger rams rest on a solid base, if necessary use larger

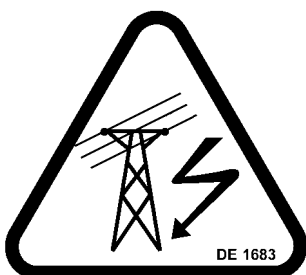



outrigger base plates (available on request) to avoid sinking. If you adopt other means, make sure that they are suitably sized for the load they must bear.

**(!) ATTENTION (!)**

**Respect the safety distances from electric lines; the minimum distance is, according to CEN norms, five (5) meters, except for otherwise prescribed by national norms.**

**(!) ATTENTION (!)**

**Failure to respect the minimum safe distances may result in electrical hazards for the operator and his assistants.**

**ELECTRICUTION:**

General safety precautions for the operator and potential co-workers. If the crane hits an overhead power line, do not touch the crane, the truck or the load.

Carefully evaluate the danger before moving. If you are closer than 10 meters from the crane, the truck, the load or the electric line, move at least 10 meters away, by shuffling away with small steps, in order to minimize the chance of getting a too high voltage difference between the feet.

Warn others to stay away; call for help and contact the power company to de-energize the line: do not attempt to assist someone in direct or indirect contact with the power line before the power has been disabled: you run the risk of being electricuted yourself.

If you are in the truck cabin, stay inside without touching the vehicle body because it's extremely hazardous to go out before the line is de-energised.

Help the electricuted person if you know the first-aid procedures, otherwise wait for the paramedics to arrive.

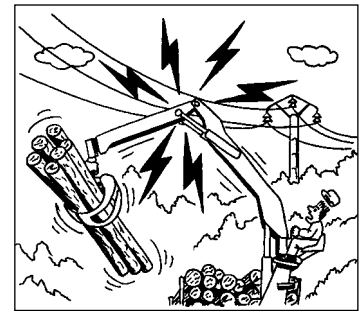

**(!) ATTENTION (!)**

**Do not utilize the crane during thunderstorms and with wind speed exceeding 13,8 m/s (50 km/h), maximum value of the Beaufort scale degree 6.**

**Indications about wind speed**

Force of the wind Beaufort scale	Wind speed m/s	Classification	Characteristics
0	0,0 - 0,2	Calm	Calm wind, smoke goes up quite vertically
1 2	0,3 - 1,5 1,6 - 3,3	Light breeze	Smoke reveals the direction of the wind, one can feel the wind blowing, leaves start fluttering.
3 4	3,4 - 5,4 5,5 - 7,9	Moderate breeze	Leaves and branches are in constant motion, small branches start fluttering. Dust and papers dance on the ground.
5	8,0 - 10,7	Fresh breeze	Small green branches bend, the surface of waterways and lakes are wavy.
<b>6</b>	<b>10,8 - 13,8</b>	<b>Near gale</b>	<b>Big branches bend, wind whistles through high-tension cables, it's difficult to walk keeping the umbrella open.</b>
7	13,9 - 17,1	Moderate gale	Trees sway, it's hard to walk
8	17,2 - 20,7	Storm wind	Branches get broken, it's hard to walk.
9	20,8 - 24,4	Storm	It damages houses(antennas and roof tiles fall down )

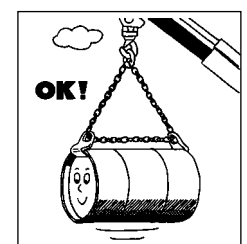
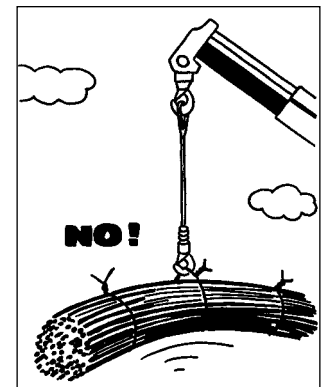

**(!) ATTENTION (!)**

**Carefully inspect the load rigging.**

Hook up the load, checking that it does not exceed the capacity indicated on the lifting diagram specific to each load configuration.

Make sure that the lifted load is balanced.

Avoid swinging the load above the control station; in cases where the load is too close,

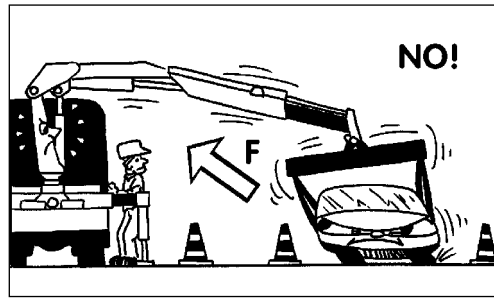

the crane must be operated from the opposite side or with the radio-remote control.

When operating through a winch, lift the load vertically using the cable and not the booms in order to avoid swinging the load. Do not rotate the crane before the load is lifted.

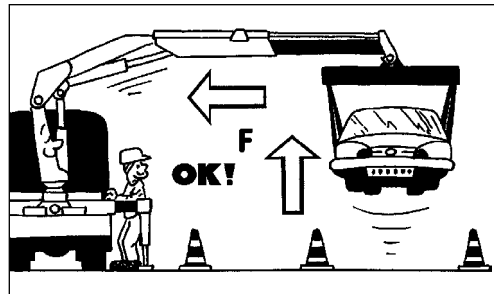

Do not operate with sudden movements, activate the controls with slow and progressive movements; rotate slowly and with care paying attention to the stability of the vehicle.

With vertical lift, on hydraulic and mechanical extension, rotate slowly in order to avoid side-skidding.

**(!) ATTENTION (!)**

Do not utilize the crane for pushpull (F), lateral (F) or sideways (F) operations.

**(!) ATTENTION (!)**

Crushing (F) or push (F) manoeuvres are not permitted.

**(!) Never operate the outriggers when the crane is loaded.**

**(!) ATTENTION (!)**

The vehicle\crane must not be left

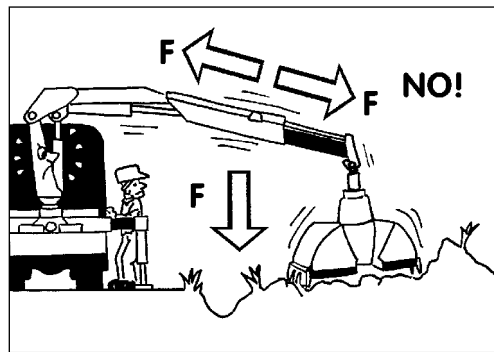

unless the load is on the ground, the booms of the crane (and of the hydraulic jib), are folded and laid on a solid base and the power take-off is disengaged.

Do not move the vehicle with the crane not in transport position and not with a load suspended on the crane.

## 7.4 At the end of the operation (Prior to driving the vehicle)

Fold the crane.

If the booms of the crane (or of the hydraulic jib) are to be laid on the body or on the load, they must be suitably blocked to prevent possible sideways movements.

Make sure that the indications about the overall dimensions are respected.

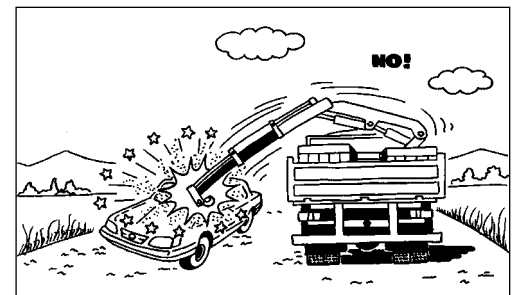

### NOTE

Implements can be left mounted on the booms of the crane (or of the hydraulic jib) only if the overall dimensions are respected; they must be suitably blocked to prevent possible sideways movements.

If an accessory (fork, ...) is mounted, it must be tied down at all times during transport.

Make sure that the outrigger supports and rams are re-entered within the overall width of the truck and locked by the safety devices.

Disengage the power take off.

## 7.5 Residual risks

Note: This reasoned list does not carry the complete list of the residual risks, which are examined more in detail paragraph by paragraph in the manual under "**(!) ATTENTION (!)**"; it is instead a way to exemplify to the operator the types of hazards linked to the use of the crane, which basically involves a lifted load in movement. Therefore we confirm you the following

**It is absolutely forbidden to use the crane without having read and understood the manual for use and maintenance and without having being previously instructed by experienced personnel on all aspects of safe crane operation.**

**Risk evaluation shall be followed by adequate provisions in order to avoid risks and damages to people and things.**

**The crane operator shall be held directly responsible for the correct operation of the crane also according to the jobsite conditions.**

**Overturn:** the crane can overturn, thus hurting people and damaging things specially in following conditions:

- if it is not correctly stabilized
- if the moment limiting device is disabled
- if the ground conditions at the jobsite are not stable enough with respect to the dimensions of the outrigger base and/or of the additional base plate
- if you increase the design dynamic increasing the pump oil flow.

**Moment limiting device:** never try to bypass nor tamper with the moment limiting device and the various safety systems installed on the crane. In such case the operator shall be held responsible for the subsequent crane performance. It is also important to understand the alarm messages generated by the "moment limiting device" and act consequently.

**Control seat:** before operating from the control seat the operator shall make sure that he's safe from hazards (i.e. he stands clear of the load, there is a way of escape,..). Otherwise he shall manoeuvre from a different control seat; if there is none available, the crane should be equipped with a radio control or remote control in order to allow the operator to operate the crane in absolute safety.

From the control seat the operator shall be able to visually inspect the whole working area at all times. If it is not possible he shall team up with a co-worker able to control the whole area; otherwise the crane shall be equipped with a radio control in order to ensure the operator with the perfect position to see all potential hazards clearly at all times. Naturally the operator shall also teach this eventually co-worker with the scope of not harm each other with control commands.

**Load rigging:** carefully inspect the load rigging; the operator shall make sure that the load is properly attached and balanced and that all unexpected movements are not allowed. Be careful not to hit any potential impediments during the crane movements.

**Jobsite conditions:** prior to use always ascertain that the working area is free and clear of potential obstacles to crane operations (people, building walls, balconies, eaves, scaffoldings, tree branches, other lifting means or machines, electric lines,...). This may hurt people, damage both the impediments and the crane, and provoke also the crane overturn.

Make sure that there is no risk of elements falling on the operator or on the crane and take the right precautions to prevent it.

**Overload and/or fatigue:** the crane can break down due to fatigue or overload:

- If it is misused (with cycles, loads or pump oil flow not pertinent to the crane class)
- If it is used for improper tasks (side, oblique or reversal pull)
- If it is used in poor jobsites (corrosive environment, too high or too low temperature, foundry,... [see conditions of use])
- If the load exceeds the rated capacity indicated on the relevant plates

**Wrong manoeuvring:** the crane can fall break or overturn if the operator performs a wrong manoeuvre due to the lack of familiarity with the operation procedures (see manual of use and maintenance) or due to inadequate psychophysical conditions: we remind you that the directives in force impose a suitable training of the personnel before using these types of machines and require an adequate psychophysical condition to operate safely a lifting device that always implies the intrinsic danger of a lifted load.

**Weather conditions:** too high or too low temperatures may damage the components of the oleodynamic and electric circuits (See max and min conditions of use); it is forbidden to operate the crane during a storm with lightning hazards, so we recommend to fold it and put it to rest. Furthermore when the wind is too strong the crane can overturn or break down.

**Shearing, entrapment:** the crane has a lot of parts in movement that it is impossible to cover; therefore the operator shall always be aware of this residual risk and keep clear from the parts in movement, particularly from the load; the operator is held responsible not only for himself but also for those working in proximity of the crane and for those who may draw closer even if not authorized.

**Electricution:** the crane is not insulated from electric contacts and therefore it is not equipped to work under tension, even if the contact is accidental. Therefore be compliant with the min clearance prescribed by the national directives in force. Generally speaking the clearance from electric lines with a max tension of 38.000 volts should be at least 5 meters: Higher tensions require higher clearance to be verified case by case together with competent technicians and with respect to the environment conditions.

**Manual extension overload:** manual extensions are controlled by the moment limiting device only under the conditions described in the relative chapter; the control system of the manual extension overload must be activated by the operator as described.

**Accessories:** be careful when assembling and disassembling the accessories (extensions, buckets, baskets,...); first verify the weight, the securing systems and the instructions for assembly and dismantlement; then appraise their barycentre and provide for adequate provisional blocking systems in order to avoid sudden movements.

**(!) ATTENTION (!)**

**If in the folding condition the hook is out of truck size, it must be taken away before travelling.**

**Breakdown of some sensors**

The system "moment limiting device - intelligent type" is always monitored during ignition (the system, after having activated the various circuits, checks the presence of all the inputs for around 4 seconds) and then continuously monitors the operation and the efficiency of the limiting device (approx. every 25 milliseconds).

For most of the components the system checks also the congruence of the incoming signal with the one the system expects.

**Maintenance:** maintenance is particularly important; the lack of it may damage things or hurt people.

**Particular operations:** if you are required to operate under particular conditions not illustrated in the manual of use and maintenance, analyse carefully the situation and always refer to an authorised Fassi shop or to the Fassi technical support service or to experienced operators before starting working.

## 8 IDENTIFICATION OF THE CRANE MODEL

### 8.1 Generality

The exact **crane model**, **serial number** and description of **implements** will enable **FASSI Service Department** to give a rapid and efficient response.

### 8.2 Crane mark

The CE indicates that the crane complies with the Machines Directive (D.M.) 98/37; it can be considered effective only with a written declaration of conformity enclosed. The crane affixed with the CE mark is supplied with a lifting moment limiting device to preserve the crane structure from overloads.

Identification data are marked on the plate DE5891 used for the CE mark (fig. 2) and rivetted on the base with personalized rivets FASSI.

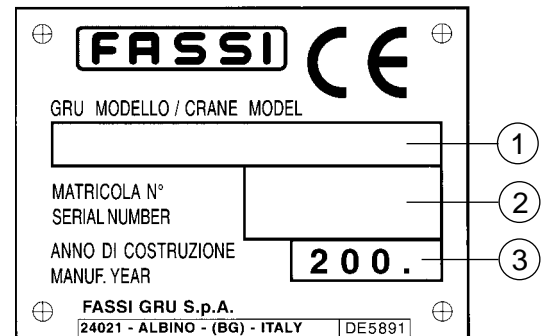

fig. 2

- 1 - Crane model
- 2 - Serial Number
- 3 - Year of manufacturing

The crane must not be put into service within the European Community unless the machine on which it is mounted also conforms with the prescribed Directive. Ever change of use, modification or addition of accessories, not specified by this manual must be affixed with a new CE mark in accordance with the Machinery Directive.



A further metallic plate (fig. 3) fixed to the crane by the installer, quotes the identifying data of the equipment and the final CE mark.

- 1 - Name of the installer who applied the final CE mark
- 2 - Crane mark, model and serial number
- 3 - Vehicle mark, model and chassis number
- 4 - Year of mounting

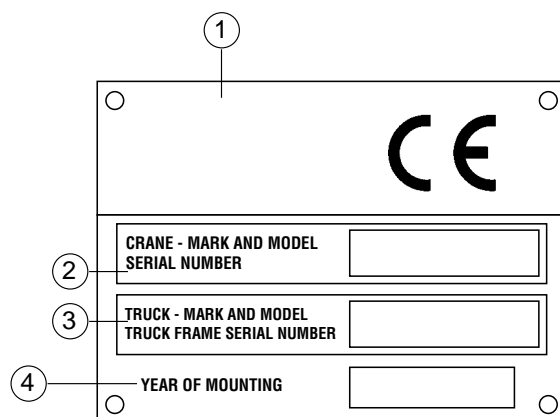

fig. 3

**(!) UNDER NO CIRCUMSTANCES SHOULD THE DATA MARKED ON THE PLATES BE ALTERED.**



# 9 CRANE NOMENCLATURE

## 9.1 Version with ground controls for crane and outriggers (fig. 4).

Pos.	Description
1	- Outrigger rams
2	- Outrigger supports
3	- Base
4	- Rotation cylinders
5	- Distributor bank (control for outriggers-crane)
6	- Double distributor device (outriggers-crane)
7	- Column
8	- Inner ram
9	- Inner boom
10	- Outer ram
11	- Outer boom
12	- Booms extension rams
13	- Extension boom sections
14	- Lifting hook
15	- Oil tank
16	- Manual extensions (optional)

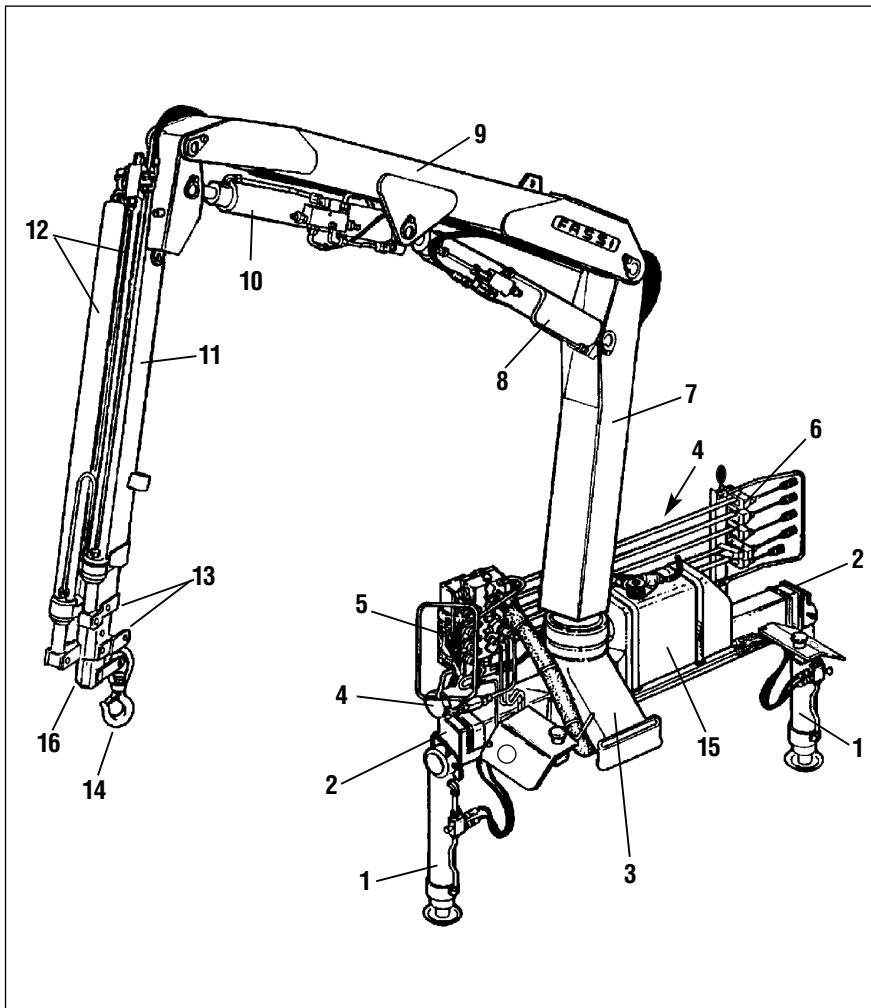

fig. 4

## 10 NOMENCLATURE OF THE SAFETY AND PROTECTION DEVICES

### 10.1 Version with ground controls for crane and outriggers (fig. 5).

Pos.	Description
1	- Check valves for outrigger rams
2	- Check valves for rotation control
3	- Check valve for inner ram
4	- Check valve for outer ram
5	- Check valve for booms extension rams
6	- Lifting moment limiting device assembly
7	- Control panels
8	- Rotation limiting device
9	- Main pressure valve of the distributor
10	- Auxiliary valves of the distributor
11	- Levers guard
12	- Safety device for outriggers supports
13	- Hook safety device

Before crane use check that safety and protection devices are fitted and active.

Under no circumstances interfere with the safety and protection devices.

Interference with the check valves and removal of the lead seal remove the Manufacturer and invalidate the warranty.

Use the ladder for the access to the top seat.

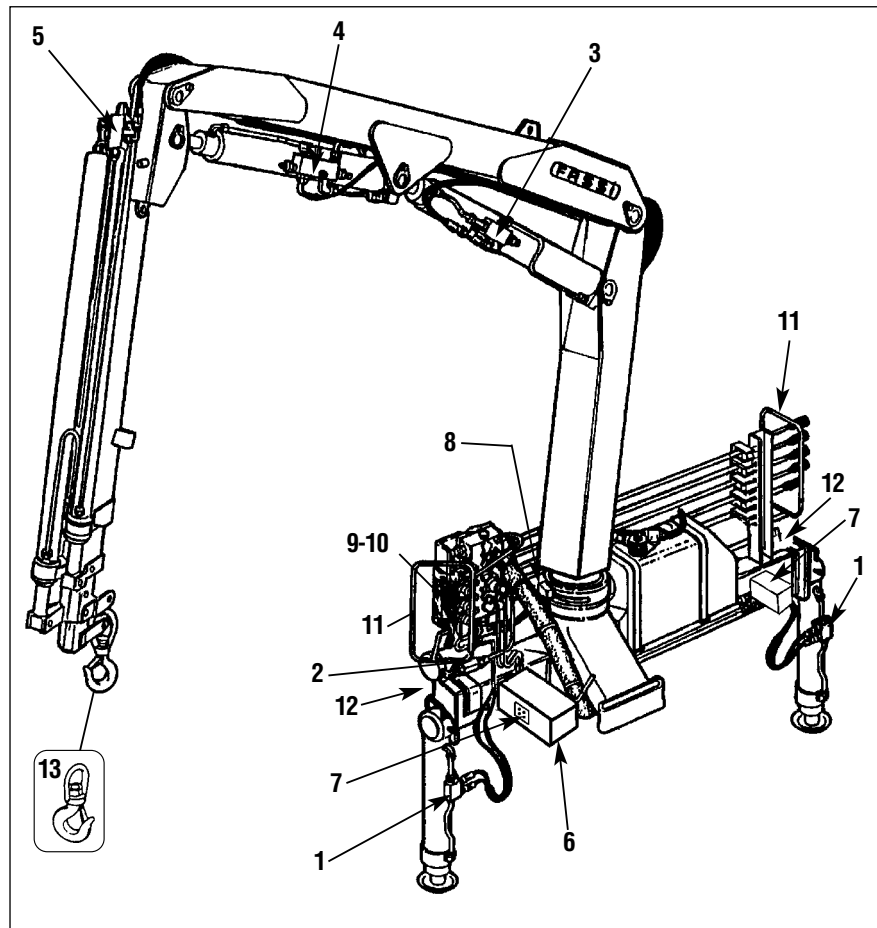

fig. 5



## 11 SUPPLEMENTARY BEAMS

### 11.1 Generality

Supplementary beams are used in conjunction with the crane outriggers to ensure the vehicle stability during load handling.

Code	outrigger ram stroke mm	outrigger interaxis mm	extension type	Weight kg
48019	440	1860	Fixed	60
48018	440	2500	Manual	80

### 11.2 Identification of the supplementary beams

Identification data of the supplementary beam is punched on the beam (fig. 8) in the following sequence:

Ex. \*48019\*0001\*  
| serial no.  
| identification code

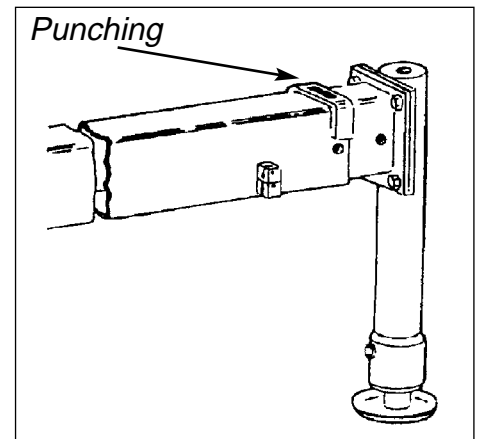

fig. 6

## 12 TILTABLE OUTRIGGER RAMS

### 12.1 Manually tiltable outrigger rams

They are outrigger rams, which can be placed in an inclined (at 30°) or vertical position (at 180°) to avoid obstacles on the truck frame.

After the extension of the lateral outrigger supports, place the outrigger rams in a working condition as follows:

- Supporting the ram, remove the check pin and the locking pin from their positions (fig. 7); when the ram is in the vertical position, a stop prevents (fig. 7a) it permits from overturning.
- Position, carefully, the ram in working condition, insert the locking pin in its new position (fig. 7b) and secure it with the check pin.

To re-position the rams to the folded position.

- Remove the check pin and the locking pin from their position.
- Carefully position, the ram in a upward direction and support the ram, insert the locking pin in its new position and secure it with the check pin; if the ram is placed in a vertical position, a rotation stop prevents overturning.

**(!)** The locking pin is held to the base structure by a chain in order to prevent its loss.

- (!)** The locking pin is constructed from special material
- do not replace it with a non original part
  - your security depends on it



fig. 7



fig. 7b



fig. 7a



# 13 MANOEUVRES AND CONTROLS TO STABILIZE THE VEHICLE

## 13.1 Generality

The outriggers rams prevent damaging stresses both to the frame and to the vehicle suspensions on which the crane is mounted to and assure the stability of the unit during load handling.

**Be very careful when stabilizing the vehicle; make sure that no one is or transits in close proximity of the working area of the outriggers.**

### (!) ATTENTION (!)

**The crane stability is maintained by the maximum extension of the outrigger supports, by the solidity of the base underneath the plates of the outrigger rams and by the observance of the capacity plates.** To check the maximum working pressure see Paragraph 2.3 Technical data

Check that the outrigger rams are applied on a solid base; if necessary use larger outrigger base plates (available on request) to avoid sinking.

When stabilization is complete the wheels of the vehicle must still be in contact with the ground and the suspensions must not be fully unloaded.

Stabilize the crane so as to operate on a horizontal plane with a maximum tolerance of 1,5 degrees.

While loading, it may be necessary to vertically adjust the outrigger rams to prevent an overload on the outriggers, then stabilize again.

While unloading, the outrigger rams may not be perfectly in contact with the ground because of a rise in the suspension; it is therefore recommended to stabilize the vehicle during operation to avoid an overturn.



DE 6409



## 13.2 Standard extendable outrigger supports or, on request extra-extendable outrigger supports

Manoeuvres for the manual extension of the outrigger supports

**(!) ATTENTION (!)**

To manoeuvre the supports hands must only grab the handles placed on the outrigger rams.

(Note: the pictures are related to the distributor side)

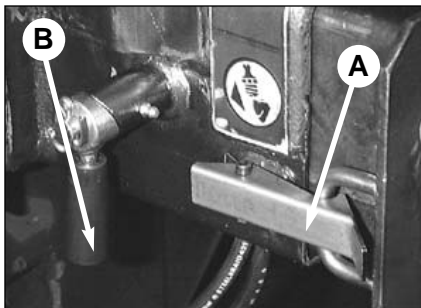

fig. 8

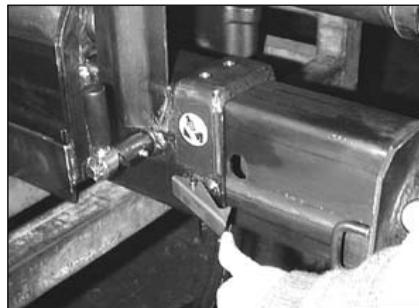

fig. 8a

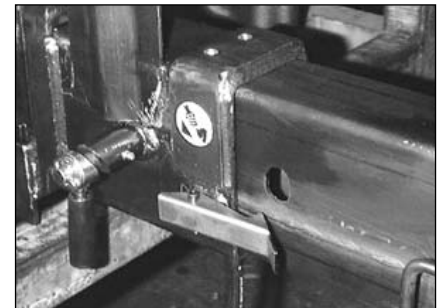

fig. 8b

- Position the lever **B** of the locking device (fig. 8), placed on the base, upwards (fig. 8a); the spring loaded security pin of the device will be released from its position.
- Release the locking device (fig. 8a) bringing it to the outside of the hook spring **A** and simultaneously pull, extending from the base the outrigger support.
- Position the lever **B** (fig. 8b) downwards; the locking loaded security device remains released.
- Pull, extending the outrigger support till the coupling of the pin.
- By the same sequence, repeat the operations described to extend the other support.

**(!) ATTENTION (!)**

The complete extension of the outrigger support is visually indicated by the yellow triangle which is found at the end of the beam. (fig. 8c)

Always check that the outriggers supports, once in their rest position, are locked in their seat by the locking devices (spring loaded security pin); this will ensure complete extension of the outrigger support (essential for the stability of the complete crane vehicle unit) and the impossibility of accidental movement.

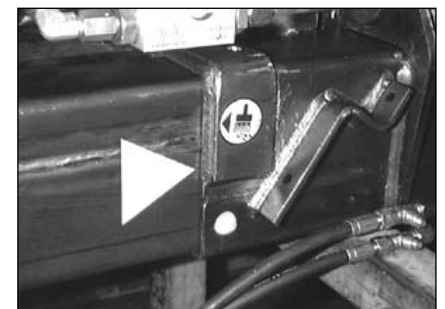

fig. 8c

Manoeuvres for the re-entry of the outrigger supports

**NOTE** Crane with extra-extension outriggers, first you must re-enter the support placed on the distributor side.

- Position the lever **B** (fig. 9) upwards; the spring loaded security pin of the device will be released from its position.
- Re-enter the second outrigger support halfway.
- Position the lever **B** downwards; the spring loaded security pin remains released. (Fig. 9b)
- Push, by re-entering, the outrigger support till the coupling of the locking devices and stops.
- By the same sequence, repeat the operations described to re-enter the other support.

**(!) WARNING (!)**

Keep hands clear of automatic stop device (hook-spring-A).

Always check that the outriggers supports, once in their rest position, are locked in their seat by the locking devices, so as to assure the impossibility of accidental movement.

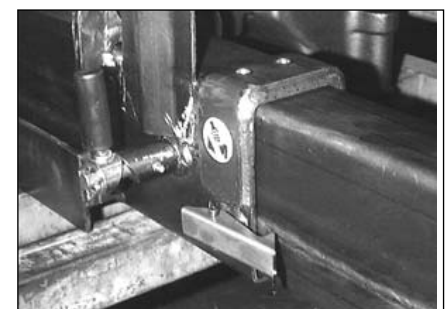

fig. 9

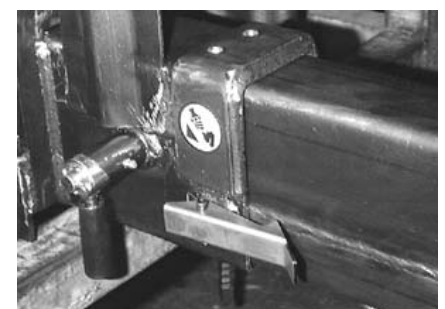

fig. 9b

### 13.3 Super extra-extendable outrigger supports (if fitted)

Manoeuvres for the extension of the outrigger supports

Distributor side

- Position the lever **B** of the locking device (fig. 10), placed on the base, upwards (fig. 10a); the spring loaded security pin of the device will be released from its position.
- Release the locking device (fig. 10a) bringing it to the outside of the hook spring **A** and simultaneously pull, extending from the base, the outrigger support assembly (first and second support).
- Position the lever **B** (fig. 10b) downwards; the locking loaded security device remains released.
- Pull, extending the outrigger supports assembly till the coupling of the pin.
- Position the lever **B**, placed on the first support, (fig.10c) upwards; the spring loaded security device will be released from its seat.
- Pull, extending a bit from the first support, the second support.
- Insert the lever **B** (fig. 16d) downwards; the spring loaded security pin remains released.
- Pull, extending the second outrigger support till the coupling of the pin is into its seat.

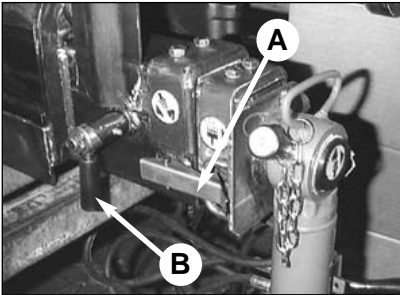

fig. 10

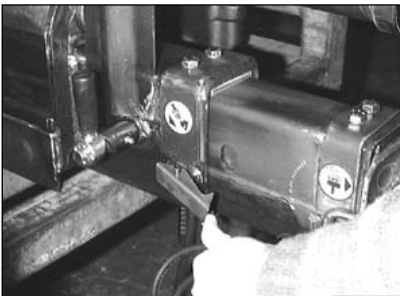

fig. 10a

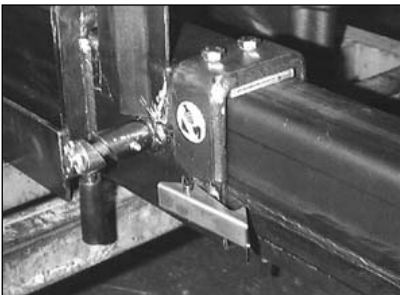

fig. 10b

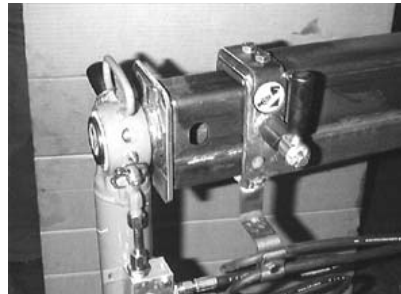

fig. 10c

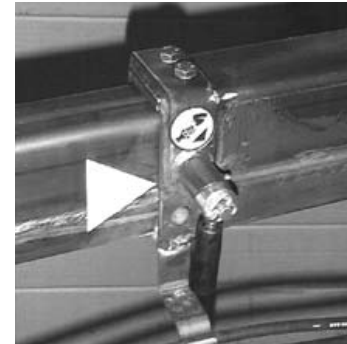

fig. 10d

Double control side

- Position the lever **B** of the locking device (fig. 17), placed on the base, upwards (fig. 17a); the spring loaded security pin of the device will be released from its position.
- Release the locking device (fig. 17a) bringing it to the outside of the hook spring **A** and simultaneously, extending from the base, the outrigger support.
- Position the lever **B** downwards; the spring loaded security device remains released. (Fig. 17b)
- Pull, extending the outrigger support till the coupling of the pin is into its seat.

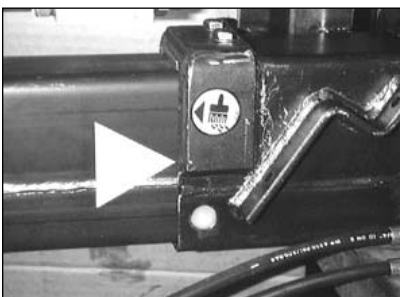

fig. 10e



fig. 11



fig. 11a

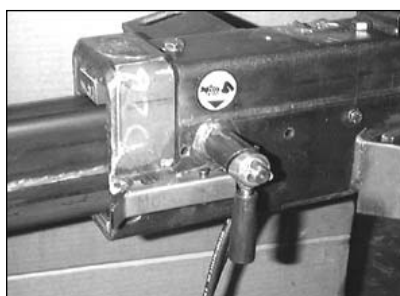

fig. 11b

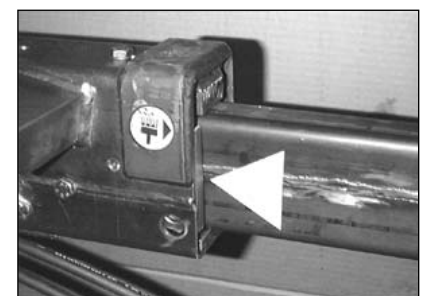

fig. 11c

**(!) ATTENTION (!)**

The complete extension of the outrigger supports is visually indicated by the yellow triangles which are found (respect to the vehicle sides when it is operated) at the end of the beam and of the first support (fig. 10d-10e-10c)

Always check that the outriggers supports, once in their rest position, are locked in their seat by the locking devices (spring loaded security pin); this will ensure complete extension of the outrigger support (essential for the stability of the complete crane vehicle unit) and the impossibility of accidental movements.

Manoeuvres for the re-entry of the outrigger supports with super extra manual extension.

**NOTE** First you must re-enter the supports placed on the distributor side.

Distributor side

- Position lever **B**, placed on the first support, (fig. 12) upwards; the spring loaded security pin will be released from it's position.
- Re-enter the second outrigger support halfway.
- Re-position lever **B** downwards; the spring loaded security pin remains released.
- Push, by re-entering, the second support in the first support, till the coupling of the pin into its seat.
- Position lever **B** (fig. 12a), placed on the base upwards; the spring loaded security pin will be released from it's position.
- Push, by re-entering halfway, the outrigger support assembly.
- Re-position lever **B** downwards; the spring loaded security pin remains released.
- Push, by re-entering, the outrigger supports assembly till the locking device is re-positioned.

Double control side

- Position lever **B** (fig. 13) upwards; the spring loaded security pin will be released from it's position.
- Push, by re-entering halfway, the outrigger support
- Re-position lever **B** downwards; the spring loaded security pin remains released.
- Push, by re-entering, the outrigger support, till the locking device is re-positioned.

**(!) WARNING (!)**

Keep hands clear of automatic stop device (hook-spring-A).

Always check that the outrigger supports, once in their rest position, are locked in their seat by the locking devices, so as to assure the impossibility of accidental movements.

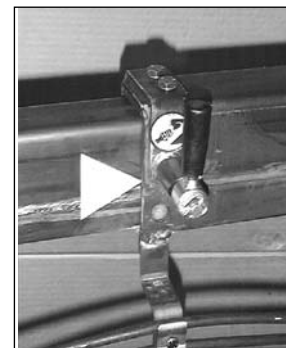

fig. 12

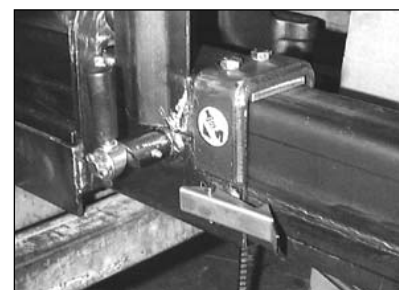

fig. 12a



fig. 13

## 13.4 Description of the controls to stabilize the vehicle

Crane with outriggers having manual side extension (or extra manual or super-extra manual extension) and supplementary beam either fixed or with manual extension.

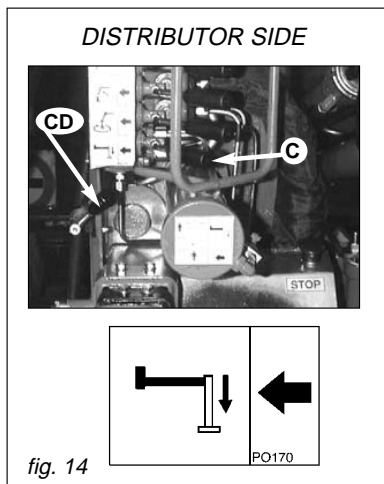

The vehicle stabilization can be operated on both sides and the controls are placed on the crane base.

### Lever function C - CD

- Lever **C** Outrigger rams control distributor for the crane and for the supplementary outriggers. Fig. 14-15
- Levers **CD** Deviator for selecting the outrigger rams; internal device facilitates the position and assures the selection is positive. Fig. 14-15

The controls of the outrigger rams, indicated in the fig. 14a-15a coincide with the plates **DE2951** and **DE2950** placed on the base, next to the control stations. The symbols and the graphics indicate the operating levers **C** and **CD** in relation to their movement.

As previously indicated

- Manually extend the outrigger supports of the crane and of the manual supplementary outriggers (if fitted).
- Position the crane outrigger rams in a working condition.

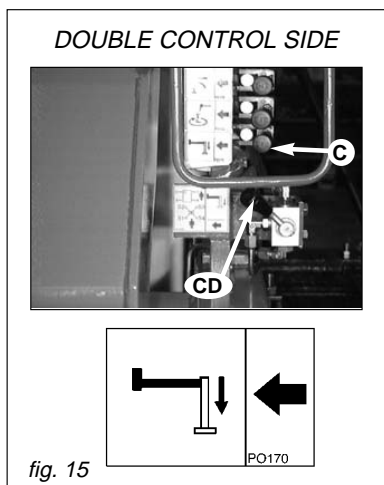

### (!) ATTENTION (!)

When controlling from the opposite side of the vehicle (it is not possible visually to check the operation) it is compulsory make sure that no one is or transits in close proximity to the outriggers.

Controls workable from both sides

- Outrigger ram descent **S2**; position lever **CD** of oil-diverter on **S2** and operate on distributor lever **C**.
- Outrigger ram descent **S1**; position lever **CD** on **S1** and operate on lever **C**. (if the supplementary outrigger beam is fitted)
- Outrigger ram descent **S3**; position lever **CD** on **S3** and operate on lever **C**.
- Outrigger ram descent **S4**; position lever **CD** on **S4** and operate on lever **C**.

### (!) ATTENTION (!)

During the stabilisation operations, for each outrigger ram, it is recommended to **DESCENT** the outrigger as the last manoeuvre.

### (!) ATTENTION (!)

The stabilization has to be carried out with care and gradually keeping the vehicle in horizontal levelled condition to prevent spring overloads and chassis twisting.

Manoeuvres for re-entry of the crane outriggers (and supplementary outriggers) within the overall vehicle width after crane use.

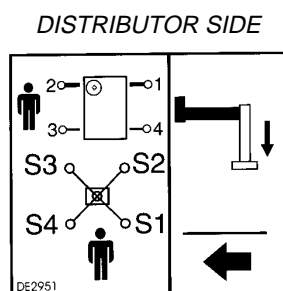

fig. 14a

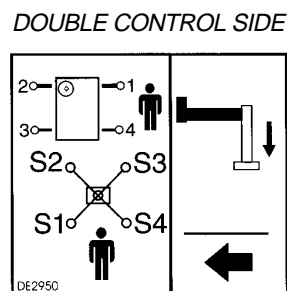

fig. 15a

Controls workable from both sides

- Re-entry of the outrigger ram **S2**; position the lever **CD** of the deviator on **S2** and operate on the lever **C** of the distributor.
- Re-entry of the outrigger ram **S1**; position the lever **CD** on **S1** and operate on the lever **C**. (if the supplementary outrigger beam is fitted)
- Re-entry of the outrigger ram **S3**; position the lever **CD** on **S3** and operate on the lever **C**.
- Re-entry of the outrigger ram **S4**; position the lever **CD** on **S4** and operate on the lever **C**.

Stow the tiltable outrigger rams and the outrigger supports (see page .. and .. )

(!) Always check that the outriggers supports, once in their rest position, are locked in their seat by the safety devices, so as to assure the impossibility of accidental movement.



## 14 CONTROLS TO OPERATE THE CRANE

### 14.1 Generality

#### (!) WARNING (!)

**Before operating the crane it is compulsory to set the outriggers.** (Plate DE2327 fig. 14)

The crane and hydraulic implements can be manually operated with:

- ground controls on both sides or, on request  
ground controls on both sides and  
top seat controls by hand-cables;
- top seat controls.

The plates reported over each lever define their function in relation to their movement.

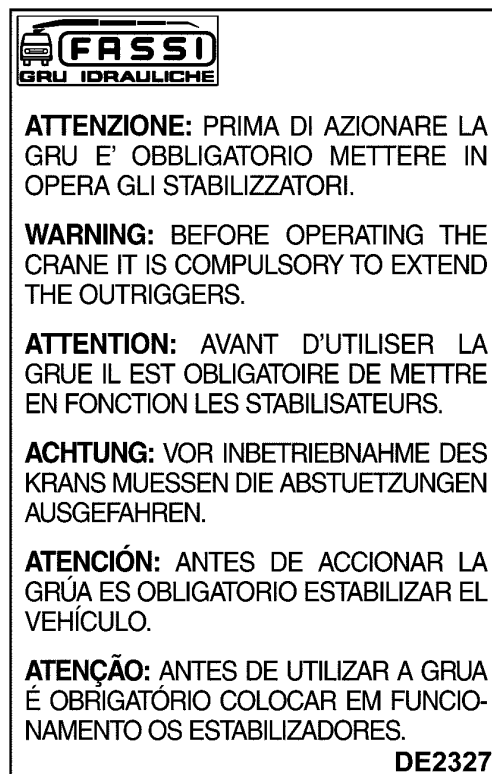

fig. 14



**(!) ATTENTION (!)**

The sequence of the plates placed on the crane controls may be different.

Make sure that the lever you are going to operate correspond to the control you selected.

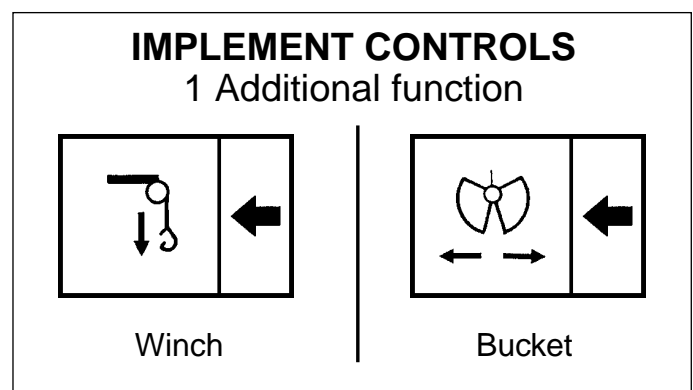
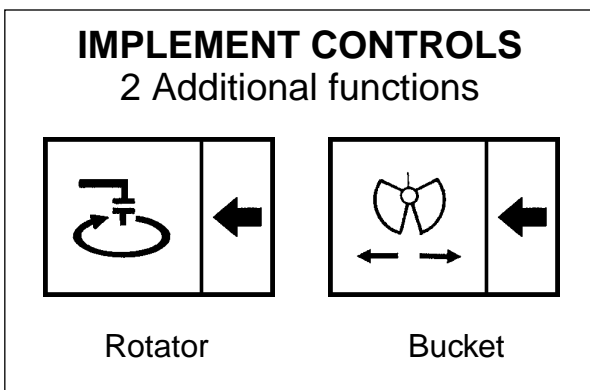
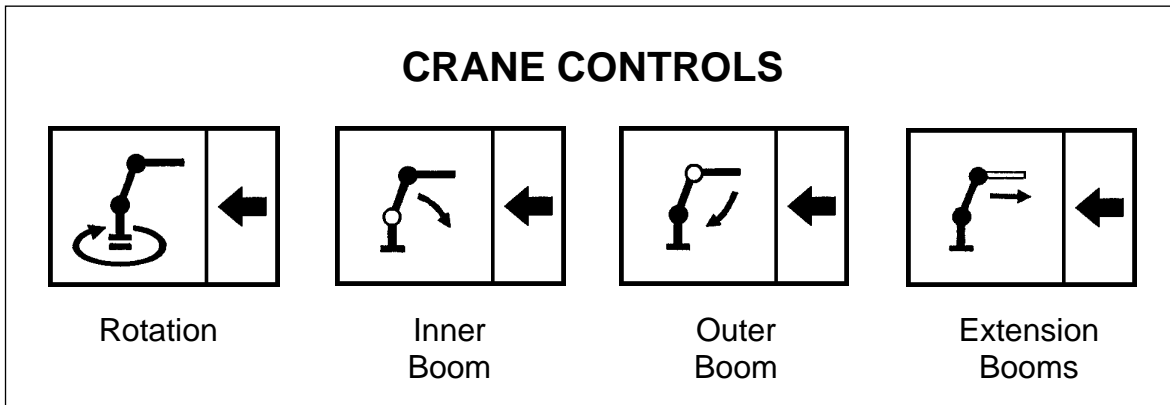

**(!) Operate the levers smoothly and gradually (!)**

When carrying out simultaneous movements of two or more functions, also related to pump flow and lever travel, it is possible that on reaching the stroke end of a particular function, an increase in speed of the other functions will occur.

**(!) WARNING (!)**

While exiting and folding the crane, you must operate from the distributor side; it is forbidden to operate from the double control side because of the overall dimensions of the booms. (DE1684A fig. 15)

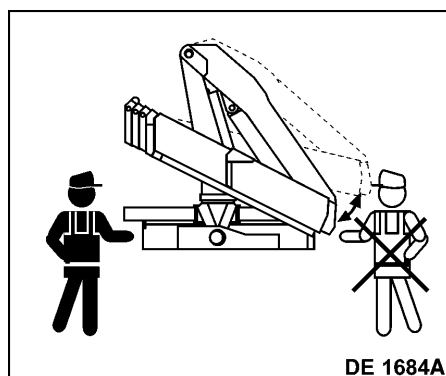

fig. 15



## 14.2 Manoeuvres to unfold the crane into a working condition

The plate DE4452A indicates the sequence of the manoeuvres to be carried out to unfold and to fold the crane.

- Engage the power take off.
- Stabilize the vehicle (see details on Paragraph 13 "Manoeuvres and controls to stabilize the vehicle").

**(!) IT IS FORBIDDEN TO OPERATE FROM (!)  
THE DOUBLE CONTROL SIDE**

**(!) Operate from ground control distributor side (!)**

By operating the corresponding levers:

- make sure that the extension booms and the outer ram are closed;
- lift the inner boom over the horizontal line;
- open the outer boom to the "horizontal" position;
- position the hook on the vertical line above the load.

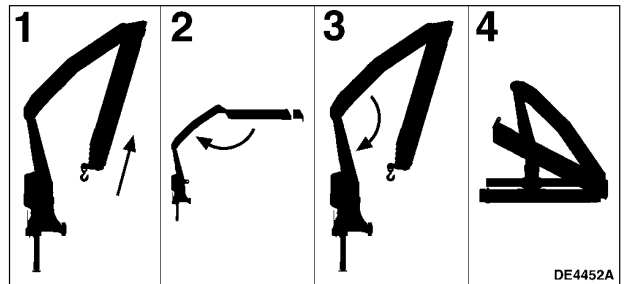
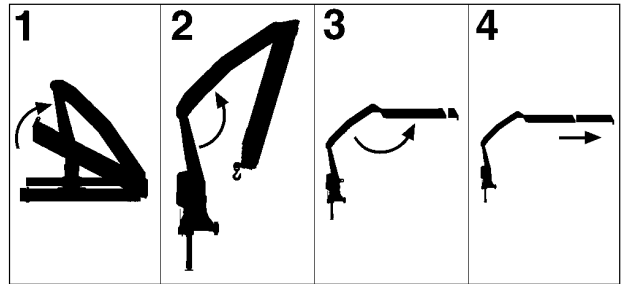

## 14.3 Manoeuvres to fold the crane into the rest condition (see Plate DE4452A)

**(!) IT IS FORBIDDEN TO OPERATE FROM (!)  
THE DOUBLE CONTROL SIDE**

**(!) Operate from ground control distributor side (!)**

By operating the corresponding levers:

- fold the extension booms to their stroke end;
- lift the inner boom to its stroke end;
- fold the outer boom to its stroke end;
- rotate the crane until the reference arrows coincide (on the column and on the base);
- fold the inner boom to its stroke end; the rest locating pin locates into its seat;
- re-position the outriggers to within the overall vehicle width as described on Paragraph 13.

**NOTE** A safety device is installed on the outer boom of the crane version "C" preventing the exit of the extension boom sections when the crane is in rest position.

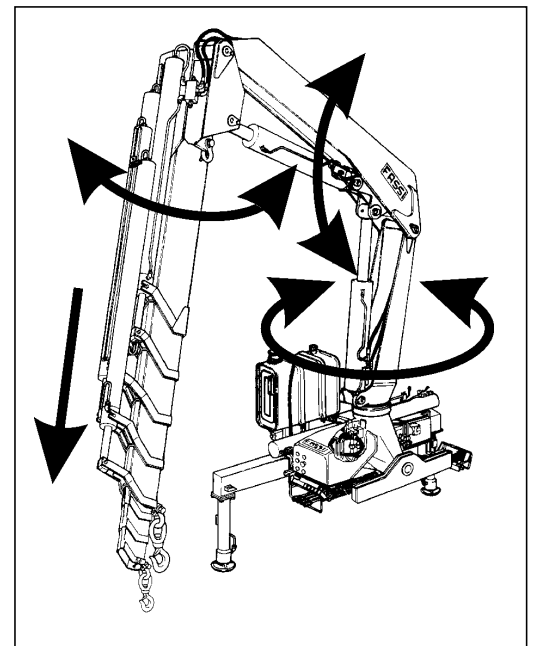

## 14.4 Manoeuvres to unfold the crane "C" into a working condition (only for the crane version C")

**(!) IT IS FORBIDDEN TO OPERATE FROM (!)  
THE DOUBLE CONTROL SIDE**

**(!) Operate from ground control distributor side (!)**

By operating the corresponding levers:

- Lift the inner boom over the horizontal line.
- Open the outer boom to the "horizontal" position.
- Extend the extension boom sections; the hook of the safety device is free.
- Position the hook on the vertical line above the load.

## 14.5 Manoeuvres to fold the crane "C" into the rest condition (only for the crane version "C")

**(!) IT IS FORBIDDEN TO OPERATE FROM (!)  
THE DOUBLE CONTROL SIDE**

**(!) Operate from ground control distributor side (!)**

By operating the corresponding levers:

- completely reenter the extension boom sections;
- lift the inner boom close to its stroke end;
- fold the outer boom to its stroke end;
- lower the inner boom until the hook of the safety device rests on the extension boom sections;
- extend the extension boom sections until the hook is correctly positioned to be attached;
- do not insist on the control!
- rotate the crane until the reference arrows coincide (on the column and on the base);
- fold the inner boom to its stroke end; the rest locating pin locates into its seat;
- re-position the outriggers to within the overall vehicle width as described on Paragraph 13.

## 14.6 Indicator of inner boom horizontal position (on request)

The column is fitted with a device that informs the driver through a sound/light signal in the cab, that the inner boom max position allowed during transport on road has been exceeded.

## 14.7 Stand-up control station

This special fitting allows the operator to use the crane controls whilst standing in a higher position, in order to have good vision of the working area.

The stand-up control station is constructed with a platform fixed on to the base of the crane and with a control panel. The control point allows the manual operation of the crane controls through remote control cables or rigid rods.

On the control panel, further to the control levers and to the plates, we can find the supplementary electric control panel (fig. 15 pos. 1).

### Controls to operate the crane.

See paragraph 14 of the USE AND MAINTENANCE MANUAL for details of "Controls to operate the crane"

See paragraphs 16 of the USE AND MAINTENANCE MANUAL for details of "Lifting moment limiting device"

**The operator's presence in the stand-up control station activates photocell L (fig. 15) that automatically prevents the crane from rotating above the station and activates the flashing of the green light in the different control panels near the plate DE5775 (fig. 16b).**

### (!) ATENTION (!)

**Before accessing the stand-up control station make sure that the photocell L pilot-light (fig. 15) is turned on and green; then check its correct functioning: if put your hand in front of the photocell the pilot-light shall turn yellow (thus enabling the limitation of the rotation path). Besides, when entering the stand-up control station, before starting the crane operation, check that the limitation of the rotation path is active, see the flashing of the green light.**

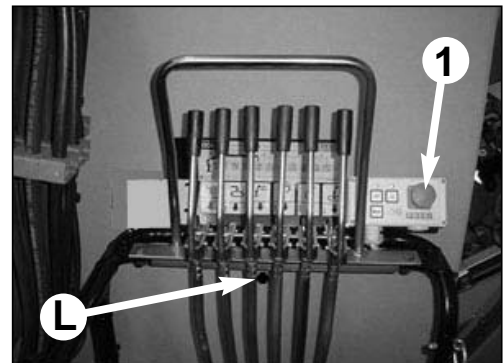

fig. 15

Always use the ladder fitted by the installer to gain access to the control station; the side of the access to the platform is protected by chain link, always replace the chain onto the structure of the platform after climbing up.

The instruction plate **DE5643** reported on the selector, identifies the intervention sectors of the device (fig. 16).

The operator's presence in the stand-up control station allows only a reduced rotation of the crane, since it is not enabled to pass on the station.

When the operator is not present in the stand-up control station, the crane is allowed to operate at its max rotation arc (which may differ from 180° indicated on plate DE5643). In case the operator is not in the stand-up control station and the rotation arc at the beginning reaches the position above the station, a red light starts flashing and a buzzer starts ringing until the aforesaid rotation arc is maintained.

If you operate from the crane dual controls (maximum rotation arc allowed), take extreme care when lowering the inner boom or while rotating the crane near the stand-up control station, in order to prevent the crane booms from clashing against the structure of the stand-up control station.

The column is fitted with a device that informs the driver through a sound/light signal in the cab, that the inner boom max position allowed during lifting has been exceeded.

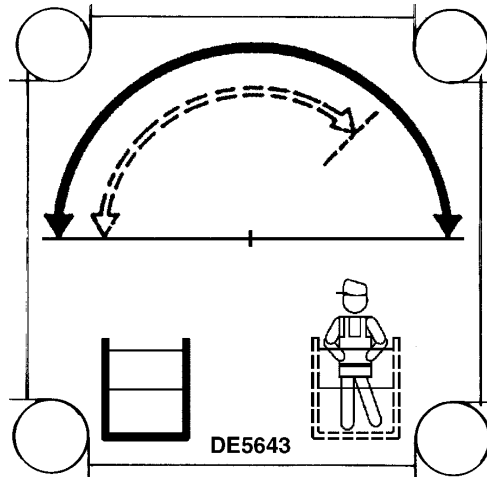

fig. 16

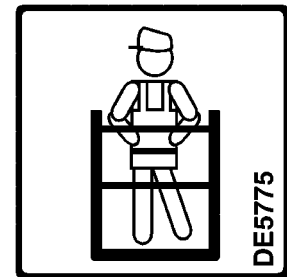

fig. 16b



### 16.1 Generality

- (!) Before manoeuvring the load, verify that the working area is suitable for your crane.

The lifting curves of the capacity plate indicate the maximum load that the crane can lift at a certain radius and at a certain height. To utilize the maximum capacity of the crane, it is necessary to position the inner boom as indicated on the capacity plate. During load handling, do not exceed the reach limits given, or the load indicated on the above mentioned charts. If the limits are exceeded, the limiting device, allowing all manoeuvres, which reduce the lifted load within the permitted reach limits and forbid all other manoeuvres, will be immediately activated.

#### Lifting moment limiting device

A characteristic which permits the classification of cranes is their lifting capacity or maximum lifting moment. The moment is defined by the value obtained from the weight of the load to be lifted (**kg**) by its distance (**meters**) from the centerline of the crane rotation.

The device called "lifting moment limiting device" preserves the crane structure from overloads, as it prevents any movement which increases the value of the moment up to the maximum established value.



## 16.2 "Electronic" lifting moment limiting device

This device utilises an electro-hydraulic system managed by an electronic logic that prevents any operation tending to cause an increase in the pressure induced by the load in the lifting rams (inner, outer rams of the crane and of the hydraulic extension, if fitted), up to the critical values. These values, which are not exceedable, determine the intervention levels and provide the data for setting the device.

The pressure values detected in the lifting rams are turned into electric signals by the transducers, and sent to the electronic logic of the device which determines the locking or unlocking of the controls concerned, according to the horizontal position of the crane outer boom (mercury level switch); only the controls allowing a reduction of the overload are enabled, while those increasing it are disabled.

The device features an electro-hydraulic control that does not allow the set value to be exceeded, by deactivating the controls (levers in neutral position) commanded by the limiting device. When the controls are released (levers in neutral position) it's this electronic logic that handles which manoeuvres are disabled, according to the position of the crane outer boom and in overload condition, by sending electric signals to special micro-switches placed on the elements of the distributor.

### (!) ATTENTION (!)

**The presence of the lifting moment limiting device does not release the user from the obligation to respect what is indicated on capacity plates and lifting curves.**

## 16.3 Control panels

Layout of the control panel (fig. 17), placed next to the distributor of the crane

A - green, yellow and red led band signalling the load percentage as compared to the capacity plate

Green light	load between 0 and 90%
Yellow light	load between 90 and 100%
Red light	load higher than 100%

B - Display

C - Control buttons (4 control buttons)

D - "STOP" button

E - Audible alarm push button (danger)

F - Green warning light (electric on)

G - Control button for XP

H - Control button for the temporary exclusion of the lifting moment limiting device

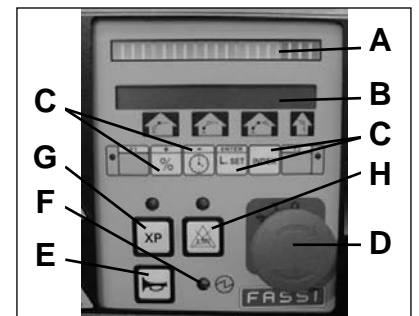

fig. 17

Layout of the control panel (fig. 18) placed on the double control side and on top seat (version with hand-cable controls)

D - "STOP" button

E - Audible alarm push button (danger)

F - Green warning light (electric on)

G - Control button for XP

H - Control button for the temporary exclusion of the lifting moment limiting device

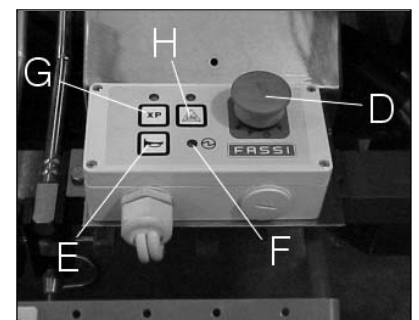

fig. 18

If the **green warning light F** comes on, it confirms that the electric circuit is active.

**!NOTE!** In the absence of electric power all crane functions will be deactivated.

If the **yellow led A** comes on during load handling, 90% of the capacity (lifting moment) has been reached.

If during operation the **red led B** comes on, the activation value of the lifting moment limiting device has been reached.





Any hidden danger situation for persons must be audibly alarmed by pressing the push button **E**.

When there are serious, imminent and dangerous conditions for persons and things during load handling, operate on the **STOP** button, which isolates all crane functions.

### Display on the control panel

When the electric feeding has been activated (after the version's number of the software) the pressure in the inner, outer ram and the jib and the percentage of load on the winch are displayed.

In relation to the view chosen like standard, when you start the radio remote control the pressure values are displayed in:

- "bar" if on the display, on the left of the values, no symbol is present.
- "daPsi" if on the display, on the left of the values, the symbol \* is present.
- By pushing the button  the percentage values of pressure in the inner, outer ram and the jib and the percentage of load on the winch are displayed. By pushing a second time the button  the pressure values in the inner, outer and jib rams movement in the measurement unit non standard and the percentage of load on the winch are displayed. By pushing again the button  you return to the initial display.
- For the use of the control button  see Par. 22.2.
- By pushing the button  one or more times you return to the initial display (view of the pressure values).
- For the meaning of other messages see Par. 16.7.1 "Diagnostic"

## 16.4 Load handling

### Manoeuvres of the crane

Fig. 20a-b e 20c-d illustrate the configurations of the crane (and of the eventual hydraulic extension) with the manoeuvres allowed and not allowed by the device, in connection with the horizontal position of the crane and extension outer booms.

#### (!) ATTENTION (!)

In the overload condition, if you simultaneously effect one permitted and one non permitted manoeuvre you haven't movement. In the overload condition, before effecting a permitted manoeuvre, it is necessary to return all the levers to the neutral position.

#### (!) ATTENTION (!)

During load handling with the crane and with the crane and hydraulic jib, in vertical configuration or close, the operator must strictly refer to the loads indicated on the capacity plates since the limiting device shows to be not particularly sensitive with vertical lifts.

Crane with activated limiting device by the intervention of the crane or the hydraulic jib (overload condition) and with outer boom of the crane above the horizontal line fig. 20a-20b

Manoeuvres not allowed:

- Inner boom descent
- Outer boom descent
- Extension of the crane extension boom sections (\*)
- Lift and descent of the hydraulic jib
- Extension of the extension booms section of the jib
- Winch rope lift
- Movement of the hydraulic accessories (\*\*)

- NOTES:** (\*) If the overload condition has been activated by the hydraulic extension, the extension of the crane boom sections is permitted.  
(\*\*) It is permitted only when coupled with permitted manoeuvres.

Manoeuvres allowed: all the manoeuvres that bring the load closer to the column and therefore the overload

- Rotation in both directions
- Inner boom lift
- Outer boom lift
- Re-entry of the crane extension boom sections
- Re-entry of the jib extension boom sections
- Winch rope descent

Crane with activated limiting device by the intervention of the crane or the hydraulic jib (overload condition) and with outer boom of the crane under the horizontal line fig. 20c-20d

Manoeuvres not allowed:

- Inner boom lift
- Outer boom lift
- Extension of the crane extension boom sections (\*)
- Lift of the hydraulic jib
- Extension of the extension booms section of the jib
- Winch rope lift
- Movement of the hydraulic accessories (\*\*)

- NOTES:** (\*) If the overload condition has been activated by the hydraulic extension, the extension of the crane boom sections is permitted.  
(\*\*) It is permitted only when coupled with permitted manoeuvres.

Manoeuvres allowed: all the manoeuvres that bring the load closer to the column and therefore the overload

- Rotation in both directions
- Inner boom descent
- Outer boom descent
- Re-entry of the crane extension boom sections

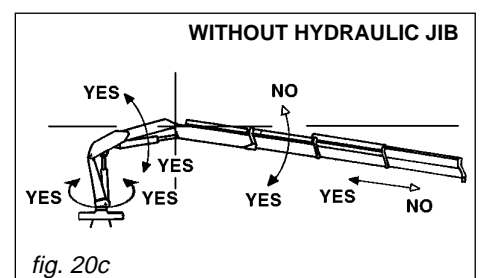
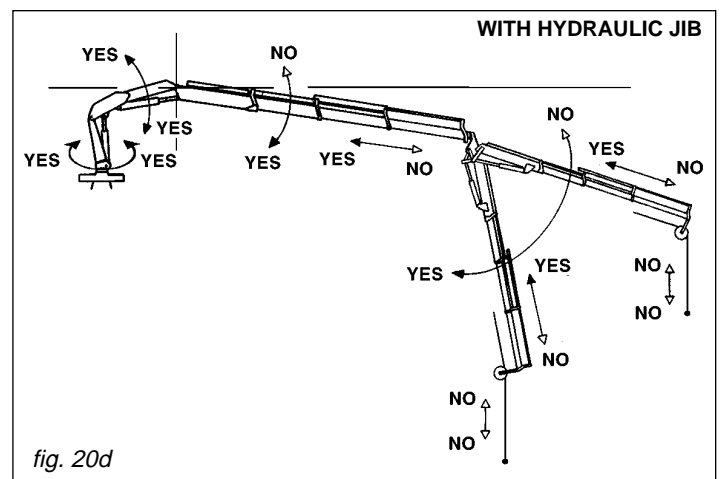
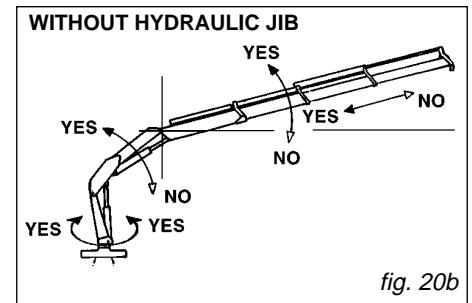
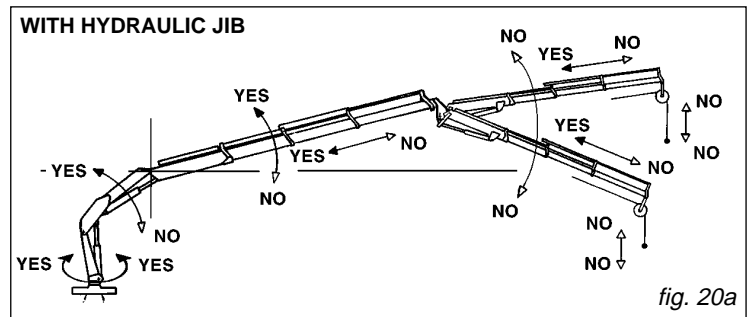

- Descent of the hydraulic jib
- Re-entry of the extension booms section of the jib
- Winch rope descent

### **Crane with activated limiting device (overload condition) by the intervention of the load limiter of the winch**

Manoeuvres allowed:

- Rotation in both directions
- Re-entry of the crane extension boom sections
- Re-entry of the jib extension boom sections
- Winch rope descent

Manoeuvres not allowed:

- all other movements

### **Crane without load applied and activated limiting device**

The limiting device may intervene also during loadless crane operation following a pressure peak provoked by the attainment of the stroke end of the lifting ram at high speed. In this condition, reactivation of the crane commands by performing one of the manoeuvres is allowed by the system. If the limiting device intervenes when both the lifting rams are open and at stroke end, and the crane extension booms are fully folded, it is not possible to reactivate the commands, since the permitted manoeuvres (arm lifting and extension fully retracted) cannot be carried out, because of the actual configuration of the crane (outer boom above the horizontal). The device, in this case, allows the descent manoeuvres since it verifies that it was a peak pressure inside the lifting rams; the crane being loadless, thus these manoeuvres will be allowed.

### **Temporised exclusion device of the lifting moment limiting device**

The activation of the exclusion device is permitted when the limiting device is activated and only in the case when it is impossible to carry out any of the allowed manoeuvres. This generally occurs when handling heavy and bulky loads, with the outer boom above the horizontal and the extension boom sections almost retracted.

#### **(!) ATTENTION (!)**

**The activation of the exclusion system for the lifting moment limiting device can ONLY be operated when the extension booms of the crane and of the hydraulic jib (when fitted) are fully retracted.**

The activation button of the excluding device, **only in the case of the crane**, are to be activated as follows:

- retracted the crane extension booms until stroke end and momentarily pressurise;
- maintain the command for the extensions boom until the red led of the button LMI placed on the control panel begins to flash;
- continue to keep the command for the extensions boom and press the exclusion device button, the flashing red light becomes fixed;
- release the lever commanding the extensions booms.

The permitted manoeuvre is the descent of the outer boom in order to bring it under the horizontal; remember that you have at your disposal **five (5)** seconds from the command operation to carry out the descent. After such period of time, wait at least **one (1)** minute in order to be allowed to carry out the manoeuvre once again.

The activation button of the excluding device, **only in the case of the hydraulic jib**, are to be activated as follows:

- retracted the extensions booms of the hydraulic jib until stroke end and momentarily pressurise;
- maintain the command for the extensions of the hydraulic jib boom until the red led of the button LMI placed on the control panel begins to flash;
- release the lever commanding the extensions booms of the hydraulic jib;
- within 3 seconds from releasing the lever commanding the extensions booms of the jib, retracted the extensions booms of the hydraulic jib until stroke end and momentarily pressurise (the red led turns off as soon as the re-entry begins);
- maintain the command for the extensions boom until the red led of the button LMI placed on the control panel begins to flash;
- continuous to keep the command for the crane extensions boom press the exclusion device button, the flashing red light becomes fixed;
- release the lever commanding the crane extensions booms.

The permitted manoeuvre is the descent of the outer boom in order to bring it under the horizontal; remember that you have at your disposal **five (5)** seconds from the command operation to carry out the descent. After such period of time, wait at least **one (1)** minute in order to be allowed to carry out the manoeuvre once again.

**(!) ATTENTION (!)****Activation of the exclusion device of the lifting moment limiting device.**

When the operator uses this device, it means that he wishes to override the lifting moment limiting device in order to make some manoeuvres (which would be impossible with the device active) that bring the moment to within the maximum level, but involve an overload condition. In such an emergency condition (where the lifting moment limiting device has been disabled), the operator, who is the main responsible for the machine safety, must:

- carefully consider the manoeuvres required to return to normal working conditions: it is however compulsory to effect the re-entry of the extension booms at first,
- calmly and carefully assess the type and scale of the hazards arising from these manoeuvres and the possible reaction of the crane (tipping over, frame overload, uncontrolled fall of the load due to a hydraulic system overload etc.);
- make all movements as slowly as possible to reduce the dynamic overload to the minimum.

## **16.5 Lifting moment limiting device for two working sectors**

In case of one sector of the working area with reduced stability of the vehicle (e.g. sector in front of vehicle cab) the limiting device can be provided with a special function which allows to operate with a reduction of the intervention level. The reduction of the intervention level reduces the crane capacity values and this reduction value is defined in the vehicle stability calculation. Consequently the working area is divided in one sector (e.g. body side) where the crane works according to the capacity plate values and another sector (e.g. cab side) where it works with reduced capacity values. The device has consequently two intervention levels which are activated in relation to the sector of the crane working area always securing the vehicle stability.

**(!) ATTENTION (!)**

If the rotation stops by going through the working zone where the crane can operate according to the capacity plate values to the one where it can operate according to the reduced values, it means that one of the following conditions is reached:

- rotation of a load bigger than the one admitted in the reduced sector defined in the vehicle stability calculation;
- rotation without load applied but with (at least) one of the inner, outer rams of the crane or the jib (if fitted) extended and pressurised at the stroke end.

The following manoeuvres are allowed:

- the opposite rotation
- the manoeuvres allowed by the limiting device in relation to the position of the outer boom (positioned over or under the horizontal line).

## **16.6 Rotation limiting device**

When a sector of the working area exists in which the stability is insufficient (for example in the area in front of the cab) the permitted arc of rotation is limited by means of an adjustable electro-hydraulic device which only allows operation within the safe area. (Warning: persist in the operation!)

When exceeding the "safe area" the rotation limiting device only allowing:

- the opposite rotation
- the manoeuvres allowed by the limiting device in relation to the position of the outer boom (positioned over or under the horizontal line).

If a reduction of capacity is necessary because of insufficient stability of the complete unit, new capacity plates must be fixed giving the derated capacity in accordance with the final stability test.

**(!) ATTENTION (!)**

Always check carefully that the vehicle is perfectly stable, paying special attention to the area immediately in front of the driver's cabin as this is usually less stable.

**16.7 In the case of the appearance of the signal “ALARM” on the display of the control panel or of the radioremote control or in case of an electrical failure.**

In these cases, because of a fault, shown in the system, the crane is not functional any more. The checks that the operator can effect to reactivate the crane functions are the following:

- in case of an electrical failure check the connection of the feeding cables to the battery;
- in case of the appearance of the signal “ALARM” on the display of the push-button panel see Par. 15.7.1 and check if the fault can be resolved by the operator.

If the fault cannot be resolved, you must immediately go to a FASSI **authorized Center** after bringing the crane to its the rest position in relation to the conditions explained in the paragraphes 15.7.2, 15.7.3.

**16.7.1 Diagnostic (Alarms/Input/Output) LME vers. 4-5 UC 01-7**

It is possible to install on the machine some operation improvements of the limiting device not yet described here. For this purpose compare the released version of the software installed on the machine (you can read it on the display when switching on) with the one in this paragraph's heading. For further explanations please refer to Fassi service network.

All the eventual problems that the electronic device can have are shown on the display of the control panel and they create the stop of all crane functions. The visualisation of the alarm must be reset pushing the button l.m.l.d. exclusion on the main box control panel, which bring again the display in the original screen showing the pressures only if the problem has been solved. As consequence of this, when appear an alarm signal it is necessary to solve the problem because only in this case will be possible to reset the display and reactivate the crane working.



**ALARM CODES:**

- 01 - electronic card alarm
- 02 - inner ram transducer alarm
- 04 - outer ram transducer alarm
- 06 - jib articulating ram transducer alarm
- 08 - proximity sensor alarm (central one off)
- 09 - proximity (lateral one off)
- 10 - mercury sensor level alarm (connector disconnected)
- 11 - mercury sensor level alarm (sensor defect)
- 12 - winch alarm
- 14 - microswitch on the inner ram distributor segment alarm
- 15 - microswitch on the outer ram distributor segment alarm
- 16 - microswitch on the jib articulating ram distributor segment alarm
- 17 - microswitch on the extension rams distributor segment alarm
- 18 - microswitch on the jib extension rams distributor segment alarm
- 19 - microswitch on the winch distributor segment alarm
- 20 - microswitch on the rotation distributor segment alarm
- 21 - 10A fuse alarm (fuse inside the main control panel protecting the emergency circuit)
- 22 - winch stroke end device alarm

**Only for crane with slew ring:**

- 30 - inconsistency of the rotation lever movement alarm
- 31 - inconsistency of the inner ram lever movement alarm
- 32 - inconsistency of the outer ram lever movement alarm
- 33 - inconsistency of the crane extension ram lever movement alarm
- 34 - inconsistency of the jib articulating ram lever movement alarm
- 35 - inconsistency of the jib extension ram lever movement alarm
- 36 - inconsistency of the winch lever movement alarm
- 40 - CAN-BUS reading alarm on unit FX003
- 41 - CAN-BUS reading alarm on unit FX004
- 42 - CAN-BUS reading alarm on radio remote receiver unit

**MESSAGES**

**EXPLANATION**

- |                   |  |
|-------------------|--|
| "WINCH OFF"       | - information for the activation of the winch up or down.  |
| "WINCH CAL.ERROR" | - flashing warning (10 seconds each minute); it appears when the maximum detection of the winch adjustment with load is exceeded.  |
| "STOP BOOM OUT"   | - warning for the interruption of the extension boom exit because of a sudden variation of the cable tension.  |
| "STOP JIB 25°"    | - warning of not permitted activation of the lifting functions because of the activation of the maximum vertical operativity of the jib when it is complete with the 25° angle increasing. |
| "PLE"             | - activation of the speed reduction for the use of the access platform.  |

**What to do in case of alarm**

<b>CODE</b>	<b>REMEDY</b>
01	Take off the tension to the system and take on again the tension. If the problem remains, take off the tension to the system again, take on the tension and wait 12 minutes (12 minutes waiting time is a compulsory condition and needs to be checked with a watch), take off the tension to the system again, take on again the tension. If the problem remains, you must immediately go to a <b>FASSI authorised Center</b> .
02	Check the connector of the pressure transducer. If the problem remains, you must immediately go to a <b>FASSI authorised Center</b> .
04	See code 02.
06	See code 02.
08	Check if the red light on the proximity sensor is off and verify if the metallic band is rightly positioned.
09	See code 08.
10	Check that the connector of the mercury sensor level is not damage. If the problem remains, you must immediately go to a <b>FASSI authorised Center</b> .
11	You must immediately go to a <b>FASSI authorised Center</b> .
12	See code 11.
14	See code 11.
15	See code 11.
16	See code 11.
17	See code 11.
18	See code 11.
19	See code 11.
20	See code 11.
21	Replace the 10A fuse at the nearest workshop after removing the carter and the cover of the main panel FX000. (See electric schematic Par. 5)
22	See code 11.

**Only for crane with slew ring:**

30	See code 11.
31	See code 11.
32	See code 11.
33	See code 11.
34	See code 11.
35	See code 11.
36	See code 11.
40	See code 11.
41	See code 11.
42	See code 11.

<b>MESSAGES</b>	<b>REMEDY</b>
"WINCH OFF"	Place the distributor bank lever controlling the winch in neutral position.
"WINCH CAL.ERROR"	See code 11.
"STOP BOOM OUT"	Place the distributor bank lever controlling the extension booms in neutral position. If the warning appears when the winch cable lifting stroke end is not reached, place in any case the lever in neutral position and then restart to operate.
"STOP BOOM UP"	Lifting functions not available; are authorized only descent functions.

To verify the right working of the different input it is possible to use the display in the "INPUT" menu.

## 16.7.2 Temporary OVERRIDE-REACTIVATION for the crane functions with standard distributor

- In case of an electrical failure or of the appearance of the signal "ALARM" on the display **B** of the control panel of the lifting moment limiting device:

Firstly remove the protection guard. Then unscrew the fixing screws (13 mm hexagonal spanner).

On the distributor it has been installed an electro-valve with a manual locking function (fig. 22) which allows to reactivate all the crane functions in case of absence of the electric power. Only in these conditions it is permitted to remove the lead seal which protects the device. Push the button and turn it into the clockwise sense (fig. 22a pos. 1-2); the button stays in stable and closed position.



fig. 22

- (!) **When the electric power is reestablished, remember to put the button in its original position, turning it into the anti-clockwise sense. (fig. 22a pos. 3-4)**

### (!) ATTENTION (!)

#### Activation of the reactivation button.

**This activation prevents the operation of the lifting moment limiting device, consequently, the operation under such conditions can involve an overload condition. In such an emergency condition (where the lifting moment limiting device has been disabled), the operator, who is responsible for the machine safety, must:**

- **carefully consider the manoeuvres required to return to normal working conditions: it is however compulsory to effect the re-entry of the extension booms at first,**
- **calmly and carefully assess the type and scale of the hazards arising from these manoeuvres and the possible reaction of the crane (tipping over, frame overload, uncontrolled fall of the load due to a hydraulic system overload etc.);**
- **make all movements as slowly as possible to reduce the dynamic overload to the minimum.**

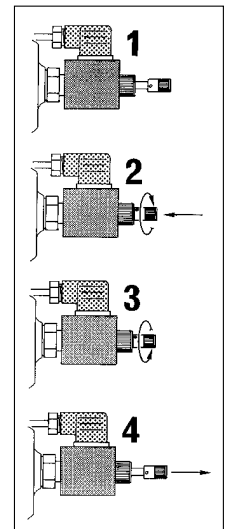

fig. 22a

After such emergency operations and prior to re-use of the crane, you must immediately go to **FASSI authorised Center** for testing the structure and re-sealing of the device.

## 16.7.3 OVERRIDE - REACTIVATION lever for the crane functions (with Danfoss distributor)

- In case of an electrical failure or of the appearance of the signal "ALARM" on the display **B** of the control panel of the lifting moment limiting device:

Firstly remove the protection guard. Then unscrew the fixing screws (13 mm hexagonal spanner).

On the distributor it has been installed an emergency tap lever (fig. 23) to be used in the event of a black-out, electrical or hydraulic malfunctions. Only In these situations it is permitted to remove the lead seal placed on the tap lever and place it in the closed position.



fig. 23

- (!) **When the electric power is reestablished, remember to put the button in the opened position.**

**(!) ATTENTION (!)****Activation of the emergency lever.**

This activation prevents the operation of the lifting moment limiting device, consequently, the operation under such conditions can involve an overload condition. In such an emergency condition (where the lifting moment limiting device has been disabled), the operator, who is responsible for the machine safety, must:

- carefully consider the manoeuvres required to return to normal working conditions: it is however compulsory to effect the re-entry of the extension booms at first,
- calmly and carefully assess the type and scale of the hazards arising from these manoeuvres and the possible reaction of the crane (tipping over, frame overload, uncontrolled fall of the load due to a hydraulic system overload etc.);
- make all movements as slowly as possible to reduce the dynamic overload to the minimum.

After such emergency operations and prior to re-use of the crane, you must immediately go to **FASSI authorised Center** for testing the structure and re-sealing of the device.

- (!) Interferences with the valves or removal of the lead seal release the FASSI GRU IDRAULICHE from any responsibility and invalidate the warranty.**

**(!) ATTENTION (!)**

The presence of the lifting moment limiting device does not release the user from the obligation to respect what is indicated on capacity plates and lifting curves.

**(!) CAUTION DANGER (!)**

On the outer boom there is a mercury capsule (mercury level switch) duly protected and provided with the following warning stickers.

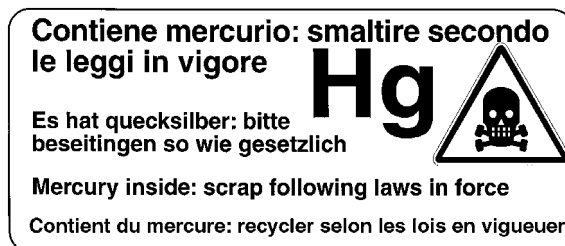

**Mercury is extremely toxic. In case of replacement and/or scrapping, dispose of or recycle the capsule containing mercury with maximum care, and in accordance with the national regulations in force.**

**(!) ATTENTION (!)**

**Do not walk on the lever guards of the lifting moment limiting device positioned on the distributors or electric control panels. DE1679**

**Do not use water to extinguish fire! DE1680**



## 17.1 Generality

The crane, in load condition H1B3, can be provided with implements such as:

- Manual extensions
- Winches
- Hydraulic extensions
- Personnel baskets
- Clam 'shell buckets
- Augers

- (!) When using an implement it is always necessary to check that its weight, dimension and capacity is matched to the crane performances.  
For further information please refer to **FASSI GRU IDRAULICHE**

Warning and norms for crane use also apply for hydraulic implement use.

Before using a personnel basket it is necessary to provide the crane with the safety devices requested by the local norms in force, EN280 in Europe, and prior to use of the crane it has to be tested and inspected in accordance with the local legal requirements.

- (!) When the crane is fitted with implements or laid on the truck body it is necessary to check they are locked to assure the impossibility of accidental movements and that the led signalling maximum obstruction in height (if fitted) confirms the correct positioning of the crane.
- (!) The crane can operate, intermittently and not continuously, with lifting devices other than the hook, only on loose and light materials (not on scrap iron).

**(!) ATTENTION (!)**

**In case of using the crane with lifting devices other than the hook, the access to the working area at the persons must be prevented.**

The dimensions and the capacity of the implements must be proportioned with crane performances.

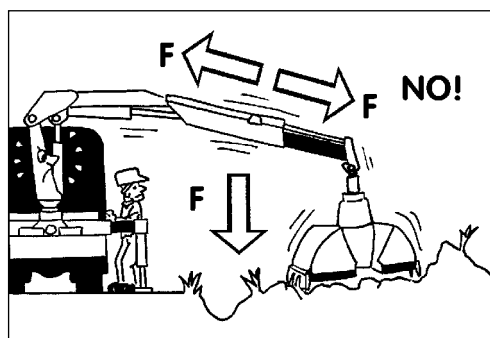

**(!) WARNING (!)**

**CRUSHING (F) OR PUSH (F) MANOEUVRES ARE NOT PERMITTED.**

## 17.2 Hydraulic connections for implements - supplementary hoses.

### (!) WARNING (!)

To ensure that the control corresponds to the implement movement, hydraulic connections are symmetrically fitted with coupling unions. Never invert such positions: movements inversion as well as operating difficulties or unusual overload with implement itself could occur.

### NOTE

When using coupling unions it is necessary to verify that there is no trace of soil, dirt etc. on the unions and inside the seats so as to avoid the oil contamination and consequently wear the tightening " surface of unions or ram seals.

## 17.3 Oil cooler (heat exchanger)

The crane is equipped with an oil cooler (air-oil heat exchanger) to prevent damage caused by an excessive increase of the oil temperature.

### NOTE

**When working in a low temperature climate, we recommend to bring the hydraulic oil up to working temperature prior to starting work, This is best done by operating the crane thru all its functions ram stroke end.**

### (!) WARNING (!)

The heat exchanger openings must be kept clear and clean. At no time should it be covered.

## 18 MANUAL EXTENSIONS

### 18.1 Generality

These are additional extensions, which are placed in the hydraulic extensions of the crane and of the hydraulic jib and secured by locking pins.

Manual extensions have a maximum capacity independent from the crane configuration as shown on the capacity plates.

#### **(!) ATTENTION (!)**

Manual extensions can be extracted from the rest position and be operative, once the security pins have been removed, with the outer boom in sliding position.

#### **(!) ATTENTION (!)**

- Do not stand in front of stabilisers during operation!  
Operate from a lateral position in respect of the extension movement of the manual extensions; operation from the frontal position is dangerous.
- Verify that the area is suitable for this operation and there are no unauthorized persons in the working area.
- Do not permit the extension to slide out at speed as this will damage the stroke end stops.
- Do not try to align the holes (slots) for the locking pins with your fingers; always use a suitable tool.
- When manual extensions are in place, fit the locking pins and secure them with the check pins to prevent accidental escape.

**(!)** Always remember that when operating with implements, their tare weight must be deducted from the capacity of the crane.

### 18.2 Lifting moment limiting device “ELECTRONIC” for the manual extensions (valid starting from the version 3.0 of the software)

#### **HOW TO CONTROL THE LOAD HOOKED ON MANUAL EXTENSIONS.**

This procedure aims to calculate the weight applied on the manual extensions. It is necessary to apply the same procedure EVERY TIME you use the manual extensions.

For its correct execution, follow meticulously the instructions reported HERE.

The extension limiting device IS NOT ALWAYS ACTIVE; on the contrary of the crane limiting device, it responds about lifting a load only if QUESTIONED, therefore only if you enable the procedure. Remember that the procedure is manual. In any case always refer to the capacity plates of the crane.

The limiting device for manual extensions, when interrogated, compares the real weight applied on the lifting hook (inclusive of all the accessories attached) with the value reported on the capacity plates. Such evaluation is effective only during the execution of the procedure, therefore it is prohibited to add weight or replace loads after the procedure is completed; in such case the procedure shall be executed again from the start.

In the case one or more manual extensions are added or removed with respect to the initial installation, it is COMPULSORY to have the crane initial configuration file modified accordingly (See Authorised Shops).

Before activating the procedure, extend and lock by a pin not only the manual extension you intend to use but also the preceding ones.

PANELS OF THE RADIO-REMOTE CONTROL

Figure A (left side)

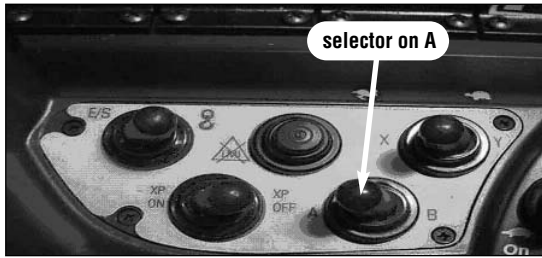
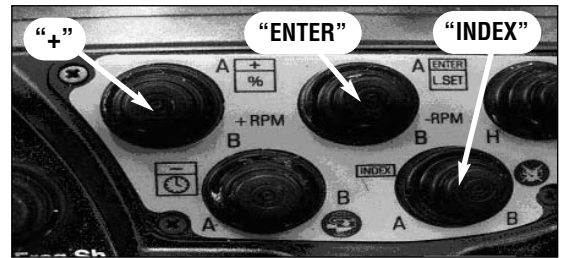

Figure B (right side)



HOW TO PREDISPOSE THE USE OF MECHANICAL EXTENSIONS ON CRANE OR ON JIB

Note: In case of crane with slew ring and top seat, all the procedures mentioned below can be executed from both the control panel and the radio-remote control.

1. Initial display (Fig. 1)

Starting from the standard menu of the electronic lifting moment limiting device displaying the pressures of the lifting rams (fig. 1), keep the "F1" key (control panel), or the "+" and "ENTER" key (radio-remote control with the selector on "A", fig. A and B) pressed for some seconds.

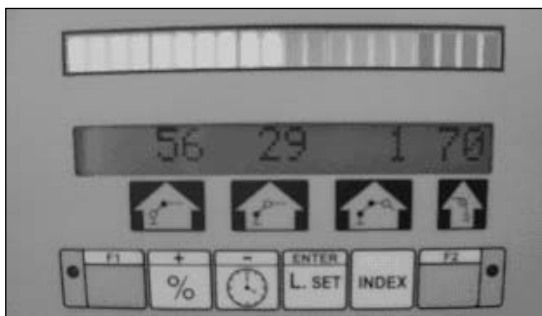

fig. 1



fig. 1

2. Choice the installation of the manual extensions on Crane or on Jib.(Fig. 2)

If the crane features the installation of the manual extensions both on the crane and on the jib, after the initial display, when you keep the "F1" (control panel) or "+" and "ENTER" key pressed (radio-remote control), the program displays the message illustrated in Figure 2.



fig. 2



fig. 2

Use the "+" button to select JIB if in the actual configuration the manual extensions are mounted on JIB or CRANE if the manual extensions are mounted on the crane.



**3. Message “M1 - M2 - M3” (fig. 3)**

After having pressed the above mentioned keys, the message illustrated in Fig. 3 will be displayed.

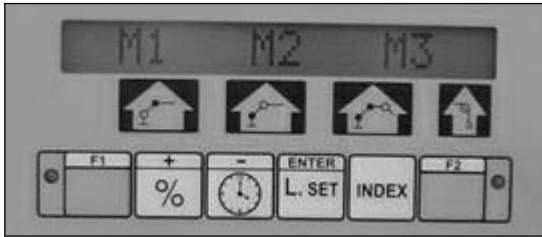

fig. 3

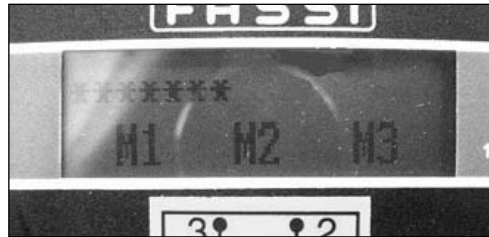

fig. 3

At this point, through the "+" button, select the correct number of the manual extension at the moment in use (M stands for manual and 1, 2 and 3 indicate the number of the manual extensions). Select the number of the manual extension you want; that number starts blinking. You can select only the manual extensions that have been installed: i.e. if only one manual extension is installed, by pressing the "+" key, only the M1 extension will start flashing. To confirm your choice, press once the "F1" key (control panel) or "ENTER" (radio-remote control); you'll access the section dedicated to the system configuration

**4. Message “K1 - K2 - K3 - K4” (fig. 4)**

[paragraph to read only in case of manual extensions installed on Jib and not on Crane]

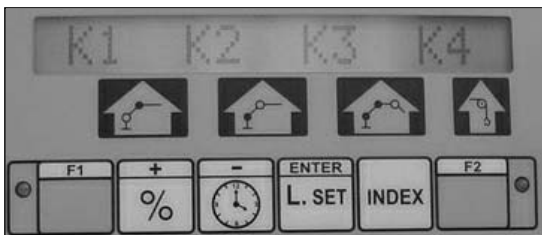

fig. 4



fig. 4

If you press the "ENTER" key with the manual extensions mounted on the jib, the screen of Fig. 4 will be displayed.

Therefore we can choose the most convenient configuration among the following:

- K1 Outer booms of the crane totally re-entered and jib extensions as you like
- K2 Outer booms of the crane as you like and jib extensions totally re-entered
- K3 Outer booms of the crane totally extended and jib extensions as you like
- K4 Outer booms of the crane as you like and jib extensions totally extended

Select the desired configuration using the \* button to move among the various options. Confirm your selection by pressing the "F1" (control panel) or "ENTER" (radio-remote control) key. If the hydraulic jib boom is not at its stroke end, the message at point 3 will be displayed; otherwise the message "F1 TO START" is visualised.

**5. Message “FC P2” (fig. 5)**

Note: do not hang any load on the hook.

This means that the outer ram must be positioned at its stroke end (if it is already in that position this message won't appear), using the lever until the next screen is displayed.

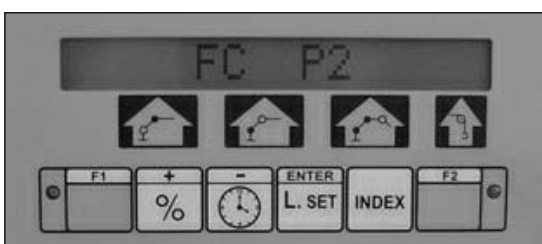

fig. 5



fig. 5

**6. Message “FC P3” (fig. 6)**  
[paragraph to read only in case of manual extensions installed on Jib and not on Crane]

Note: do not hang any load on the hook.

This means that the jib outrigger must be positioned at its stroke end (if it is already in that position this message won't appear), using the lever until the next screen is displayed.

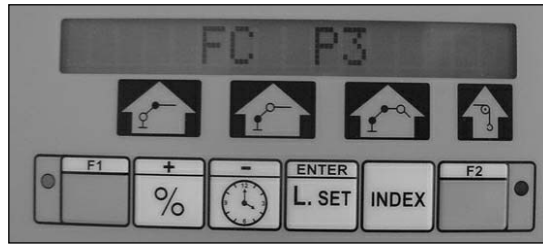

fig. 6



fig. 6

**7. Message “F1 TO START” or “F1 / ENTER START” (Fig. 7)**

At this point the display will visualize the message "F1 TO START" (control panel) or "F1/ENTER START" (radio-remote control). Press the "F1" (control panel) key or "ENTER" (radio-remote control) to continue.



fig. 7



fig. 7

**8. Message “UP P1” (see fig. 8)**

Note: do not hang any load on the hook.

It requires the activation of the inner boom lifting to eliminate an overpressure at the lifting ram bottom (the manoeuvre is activated but the crane does not move since all the movements are disabled).

Note: set the lever of the inner ram at its stroke end to simulate the lifting and keep it like this for at least three seconds.

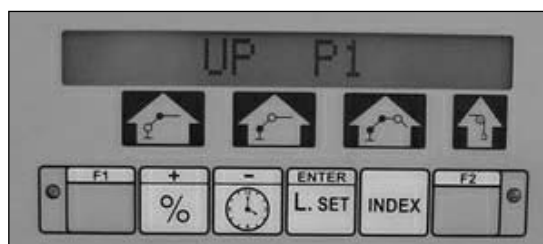

fig. 8



fig. 8

**9. Message “START LOAD P1” (vedere Fig. 9)**

Releasing the lever in neutral position the display visualises the message START LOAD P1.

It requires the slow lifting of the load using the inner ram. This allows to haul it up from the ground in order to calculate the weight which will be pointed out releasing the lever in neutral position.

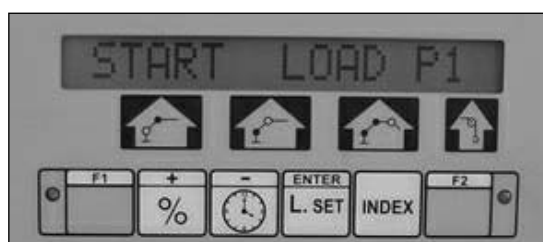

fig. 9



fig. 9

**10. Message “LOAD OK” (fig. 10)**

This message confirms that the load does not exceed the lifting limits of the crane and of the manual extension selected.



fig. 10



fig. 10

**CLOSING OF THE PROCEDURE**

All the crane functions will still be kept disabled. To start operating press the “INDEX” key (control panel fig. 10, or radio-remote control fig. D always with the selector in position “A” fig. C).



**Figure C**

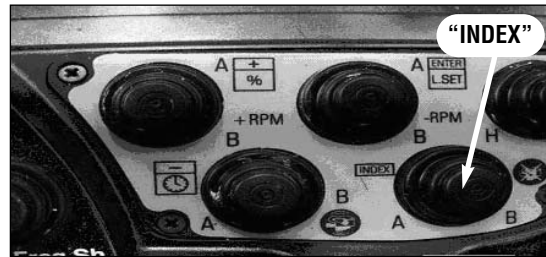

**Figure D**

For an overall view of the procedure, we attach the diagrams showing all the passages and messages that can be displayed during the procedure according to the various situations that may take place.

The script "EXIT" in the block diagram allows to exit the procedure.

**FURTHER MESSAGES**

After releasing the lever in neutral position you can find the following messages

If you keep pressed the "F2" key "F2" on the control panel or "LMI" on the push-button panel, it is possible to have an indicative evaluation of the weight applied on the hook (fig. 11).

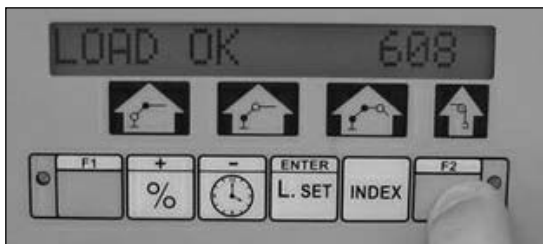

fig. 11



fig. 11

**a. “PRESSURE ERROR” (see fig. 12)**

It warns you that the system found an error in the pressures of the lifting booms. The whole procedure must be restarted.



fig. 12

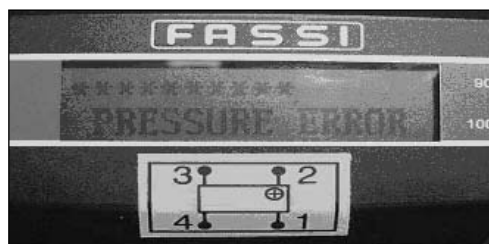

fig. 12

**b. “NO LOAD” (fig. 13)**

In this case the load exceeds the max lifting value of the selected manual extension (it could still be on the ground). Unhook the load since it cannot be lifted using the selected manual extension. As in the preceding case, if you keep pressed the "F2" key, it is possible to have an indicative evaluation of the weight applied on the hook (fig. 11).



fig. 13

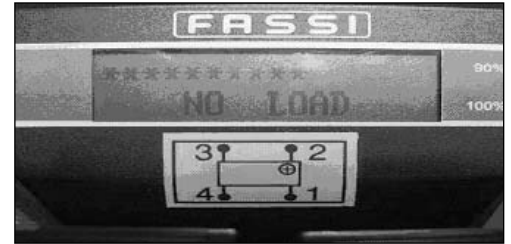

fig. 13

**c. “NO SPEED” (fig. 14)**

The load has been lifted too quickly; the whole procedure must be repeated from the beginning. The "LMI" key on the push-button panel or "F2" key on the control panel is disabled because it has not been possible to calculate the applied weight. Press INDEX on the push-button panel or "F1" key on the control panel to exit the procedure and go back to the standard operation. Put down the load on the ground and repeat the whole procedure from the beginning.



fig. 13



fig. 13

**d. “NO LOAD CRANE!” (Fig. 15)**

This message informs that the lifted load exceeds the max limit value of the crane/jib, irrespective of the manual extensions, so that the load cannot be lifted in this configuration due to the crane/jib overload. Also in this case the load must be either removed or approached to the crane, and handled in a different way without using the selected manual extension. Moreover the whole procedure must be repeated from the beginning.

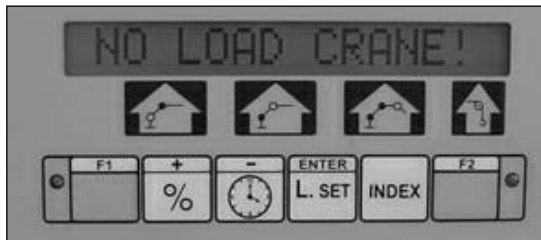
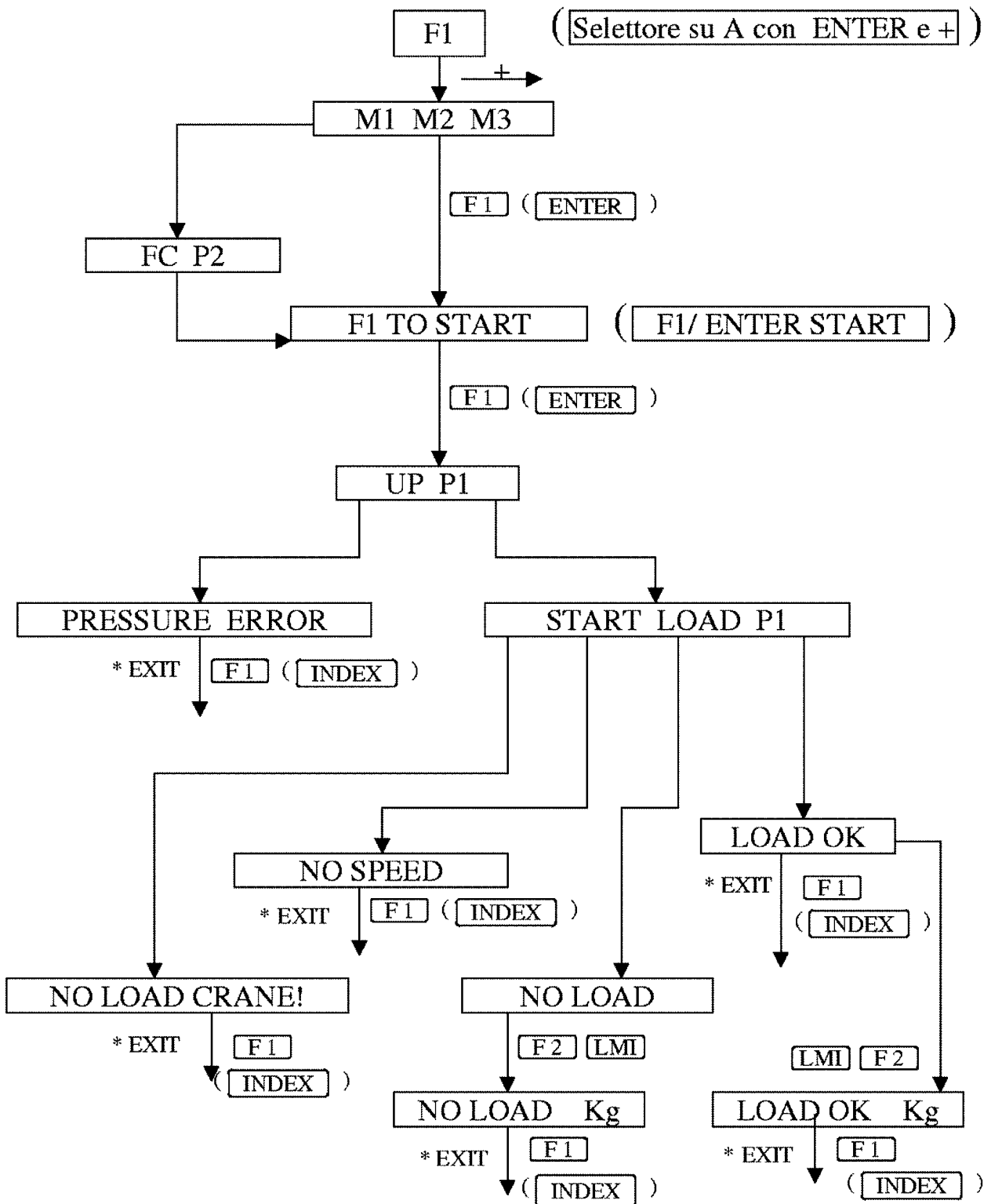

fig. 13

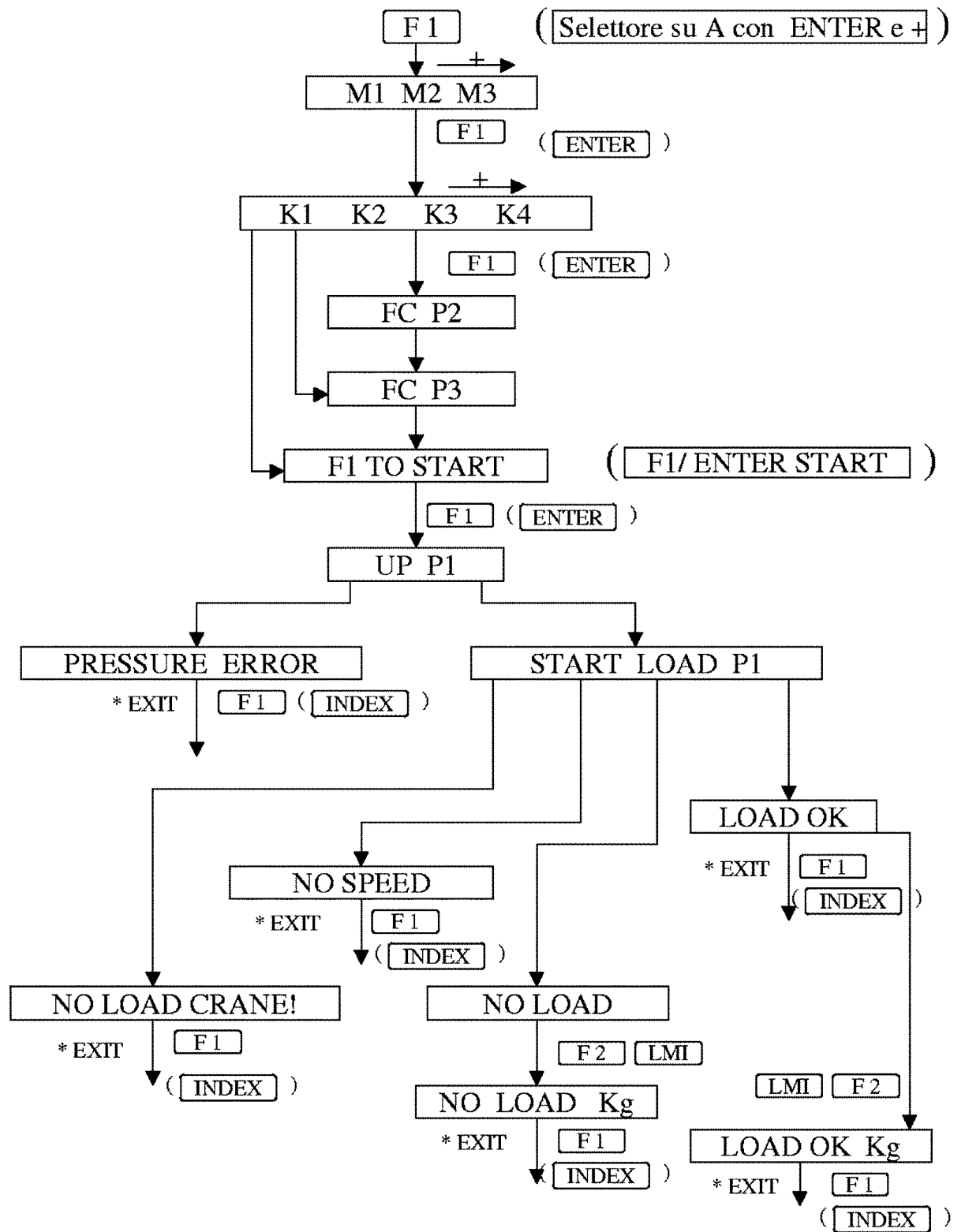

fig. 13

Electric schematic - crane with manual extensions



Electric schematic - crane with jib and manual extensions on jib



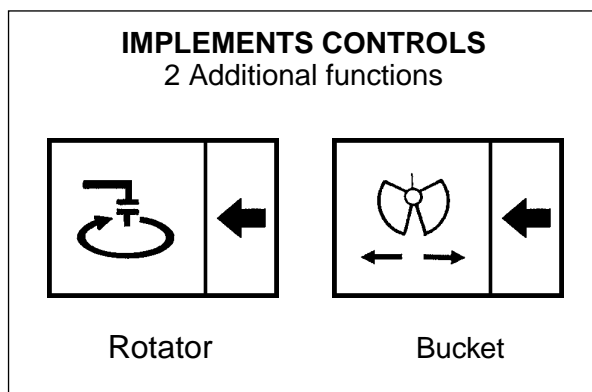
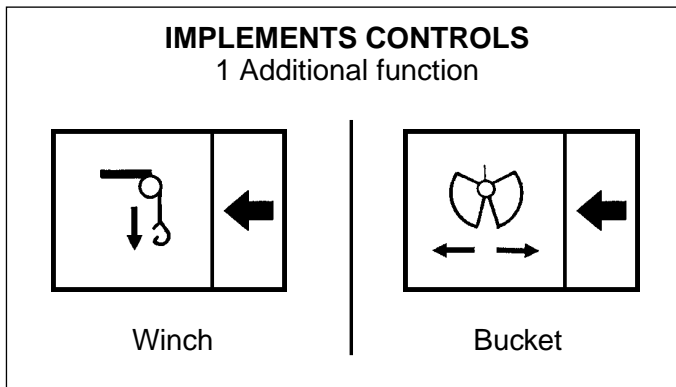

The plates placed over each lever define their function in relation to their movement.

**(!) ATTENTION (!)**

The sequence of the plates placed on the crane controls may be different.

Make sure that the lever you are going to operate correspond to the control you selected.





## 21 WINCH (when fitted)

### 20.1 Generality

The winch is made of a drum that can rotate by means of a hydraulic motor, on a structure fixed on the crane. The rotation of the drum on which the cable winds is achieved by a hydraulic motor controlled by a safety check valve connected to the crane circuit. A parking brake integrated to the motoreducer group hold the load in position when the winch control lever is in neutral position.

**Nomenclature of winch unit (fig. 23)**

Pos.	Description
1.	Winch
2.	Cable
3.	Fixed pulley
4.	Balance weight
5.	Hook
6.	Transmission pulley
7.	Block (double-triple.... line)

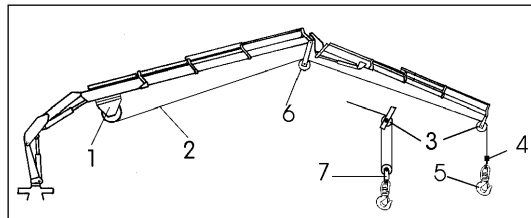

fig. 23

#### (!) ATTENTION (!)

Check the condition of wire rope.

(!) **On winches not equipped with cable layer, check the rewinding of the cable on winch drum proceeds regularly and without overlapping: it is suggested to rewind the cable only if it is sufficiently taut.**

Do not rotate the crane before the load is lifted. Lift the load vertically using the cable and not the boom in order to avoid swinging the load. With the suspended load rotate slowly and with care checking the stability of the vehicle.

### 21.2 Winch for crane

The identification data and the essential characteristics are marked on a plate fixed by the manufacturer and used for the CE mark which testifies its conformity to the Machine Directive (D.M.)

Manufacturer mark ...

Winch type ...

Serial number ...

Maximum line in N at the 4th layer...

Maximum speed in m/min ... or Maximum capacity pump l/min

(!) See operator winch manual supplied by the winches' manufacturer.

**The winch has a maximum capacity (which cannot be exceeded), indicated by a plate, not related to the crane capacities which can also be lower.**

**Consequently avoid to lift, with the winch, heavier loads than those allowed by the crane capacity plate.**

**Note:** We do not recommend using the winch with load moving (winch in or out) at the same time as the extension booms or the crane and hydraulic jib (if fitted), since it accelerates the wear of the extension guide pads reducing their life to one third compared to a standard application.

The couple limiter, installed on the winch structure, prevents that on the cable, can be created a load major to the value of maximum line at the 4th layer, quiescing all the crane controls.

(!) Under no circumstances interfere with the limiter device adjustment.

## 21.2.1 Winches equipped with a mechanical stroke end device

### (!) ATTENTION (!)

The end stroke condition takes place when the block takes contact with the pulley structure. The operator must stop the manoeuvre before the block rotates the pulley completely with consequent activation of the load cell on the winch. Such end stroke device shall be used only under emergency conditions and not as a simple end stroke interrupter.

The mechanical stroke end device combined with the winch limiter prevents the hook bracket (or pulley/snatch block) from hitting the fixed pulley when lifting or when extending the extension booms, and thus from damaging the cable.

When the winch limiter is activated, all the crane functions are disabled.

Manoeuvres allowed:

- Rotation in both directions
- Re-entry of the crane extension boom sections
- Re-entry of the extension booms sections of the jib
- Winch rope descent

Manoeuvres not allowed:

- all other movements

When unwinding, an electric device maintains at least **three (3)** turns of the lifting cable wound around the winch drum on activation the following controls are deactivated.

Manoeuvres not allowed:

- Winch rope descent

Manoeuvres allowed:

- all other movements

### (!) ATTENTION (!)

Limit the exit speed of the extension rams when, during the lifting, the hook bracket (or pulley/snatch block) is next to the fixed pulley, in order to avoid unnecessary stress to the cable.

### (!) ATTENTION (!)

When the hook bracket (or pulley/snatch block, in case of double or triple line) and the fixed pulley are very close, and the operator needs to manoeuvre in their proximity (i.e. operations like load hook-up, arms folding, etc), we recommend to always stand side on with respect to the pulley plan (never in front or at the back) and to operate the crane at a low speed, since the contact (especially without load) can result in rapid and violent rotations of the hook group (from the fig. 26 to the fig. 27).

### (!) ATTENTION (!)

The end stroke condition takes place when the block takes contact with the pulley structure. The operator must stop the manoeuvre before the block rotates the pulley completely with consequent activation of the load cell on the winch. Such end stroke device shall be used only under emergency conditions and not as a simple end stroke interrupter.



fig. 26

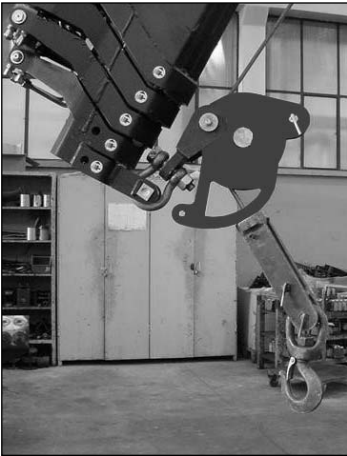
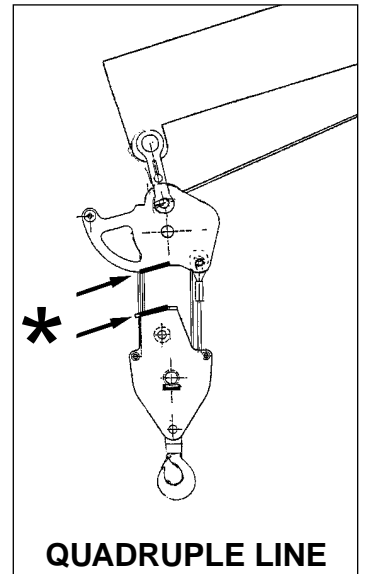
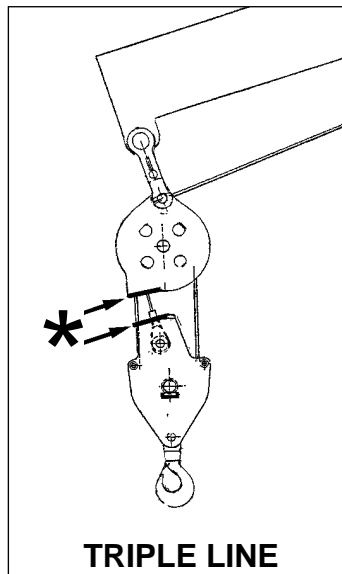
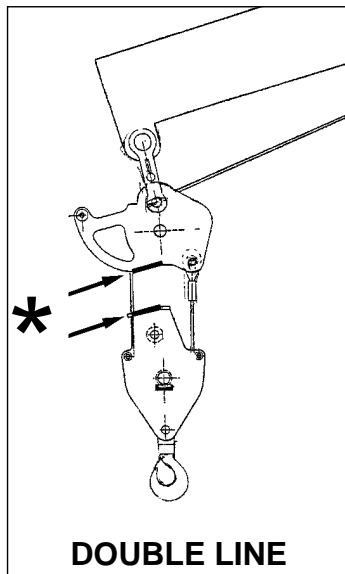
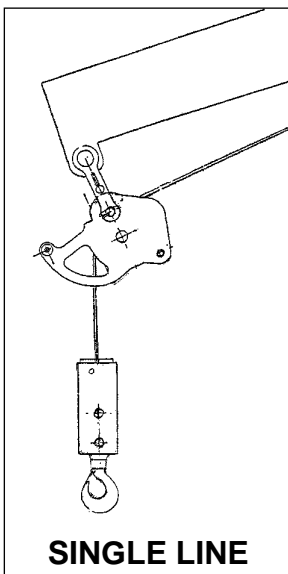

fig. 27



**\* CORRECT POSITION  
FOR THE PULLEY AND  
THE PULLEY BLOCK**

### 22.1 Generality

To assure a long life to the crane, it is necessary to meticulously follow the maintenance instructions.

General lubrication and small repairs can be carried out by the user; repairs of a more complicated nature must be carried out by authorized service personnel.

Spare parts must be original.

Good maintenance and proper use are imperative to maintain efficient use and guarantee the safety of the crane.

At least once a year you must take the crane to a **Fassi Service Center** for a check.

**(!)** Before disconnecting any hydraulic hoses, ensure that there is no pressure in the hydraulic circuit. After removing hoses always mark them and their respective ports on the crane. Faulty replacement can cause damage to the rams and to the hydraulic circuit.

Respect the information supplied for maintenance and technical assistance.

Any maintenance operation must be carried out with the crane power source turned off. (in case of fixed mounting with hydraulic power pack, the electric motor has to be turned off).

Do not place limbs, fingers or any other parts of anatomy into areas of the crane, which present possibilities of shearing, without having blocked such parts of the crane.

Do not weld, drill or grind any part of the crane without the Manufacturer's authorisation.

*fig. 29*

Do not weld the fixing rods of the crane (see plate DE1574 fig. 29)

When repairs to, or checks of, the hydraulic circuit and of the rams are carried out, it is very important not to use, or be in the proximity of, materials which can damage the circuit or contaminate the hydraulic oil eg. metal shavings, sand or dust.

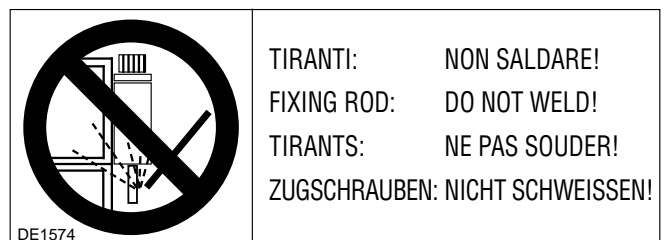

Do not use the high pressure washing on the controls (deviators, distributors, double controls, hand cable controls...), on the electronic components (boxes, control panels...), on the tanks.

Never use detergents, petrolsol or inflammable liquids, always use non flammable or non toxic liquids.

To avoid down time, it is recommended to periodically carry out the following checks.

## 22.2 Timer (fig. 29a) (if fitted)

The control panel of the "electronic" lifting moment limiting device, placed next to the distributor of the crane, features an alphanumeric readout for displaying the date, the activation time expressed in hours-minutes of the electric control panel ("Partial Time" and "Total time") or the working time of the crane whilst being operated via the control levers ("Work Time").

### How to view the date

Press button **C2** (clock/-) to have the current date visualized on display **B**. Fig. 29.

### Partial time

How to view the partial time of the electric panel; which can be reset.

- Keep button **C2 (-)** pressed until you read "**Time**" on display **B**.
- Press button **C1 (+)** until you see "**Partial time**".
- Press button **C3 (enter)** to view the time.

fig. 29a



### How to reset the "Partial time".

To start a new count perform the following:

- Keep button **C2 (-)** pressed until you read "**Time**" on display **B**.
- Press button **C1 (+)** to read "**Partial time**" on the display.
- Press button **C1 (+)** again to read "**Total time**" on the display. fig. 29a.
- Press button **C1 (+)** again to read "**Work time**" on the display.
- Press button **C1 (+)** again to read "**Reset partial**" on the display.
- Press button **C3 (enter)** to read "**Enter to confirm**" on the display.
- Press button **C3 (enter)** again; the timer is reset and it will start recording again.

### Total time

How to view the total activation time of the electric panel; this cannot be reset.

- Keep button **C2 (-)** pressed until you read "**Time**" on display **B**.
- Press button **C1 (+)** to read "**Partial time**" on the display.
- Press button **C1 (+)** again to read "**Total time**" on the display.
- Press button **C3 (enter)** to visualize, for about 5 seconds, the total time expressed in hours and minutes.

### Work time

How to view the work time which is the actual time recorded whilst a crane operating lever/function is being activated.

- Keep button **C2 (-)** pressed until you read "**Time**" on display **B**.
- Press button **C1 (+)** to read "**Partial time**" on the display.
- Press button **C1 (+)** again to read "**Total time**" on the display.
- Press button **C1 (+)** again to read "**Work time**" on the display.
- Press button **C3 (enter)** to view, for about 5 seconds the work time of the crane expressed in hours and minutes.

## 22.3 After every 8 working hours or at the end of every working day

- Check that all safety devices are efficient.
- Check the level of the hydraulic oil in the tank.
- Check all the components of the hydraulic circuit for possible leaks.
- Check that the control and the oil diverter levers can easily be positioned; they must show no signs of forcing.
- Check the condition of shackles, hooks, wire ropes and any other lifting equipment.

## 22.4 After every 40 working hours or after every working week

Check the tightening torque of the fixing rods of the crane (fig. 30).

See table at paragraph 22.5

Clean the oil filter placed in the oil tank of the crane and if any, on the pump section and pressure hoses.

**NOTE** The filters of fibre or paper can not be cleaned, they must be replaced.

Cleaning of the wire mesh filter on the tank (oil return to the oil-tank) fig. 31.

- Unscrew the security bolts of the filter cover 1 and remove it.
- Extract the cartridge, clean by flushing with a non flammable, non corrosive and non toxic solvent (gas oil or other). Thoroughly dry the filter inside and out (do not use compressed air).
- Check if the cartridge has collapsed; if so, replace it!
- Remove the filter body 3 and clean it.
- Re-assemble the filter body and the cartridge: check the sealing of the 'O' ring 4-5-6; in case, replace it!

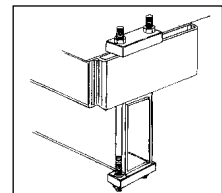

fig. 30

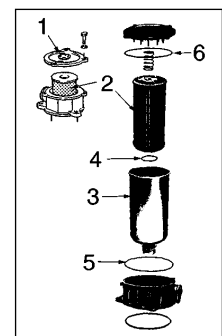

fig. 31

**NOTE** Take care that no contaminated material passes into the tank.

Replacement of the filter on the delivery line (before the distributor) fig. 32.

- When the visual indicator becomes red, replace the cartridge.
- Unscrew with a suitable spanner the filter body (1) from the head (2).
- Remove the cartridge (3) and clean inside the holder (1).
- Insert a new cartridge and re-assemble the filter body into the head checking the seal (4).

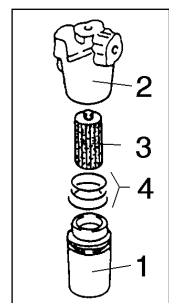

fig. 32

Check the oil level in the tank with the crane in the folded position and with the outriggers (crane and supplementary) fully re-entered. The oil level must not exceed the maximum or be lower than the minimum (fig. 33).

Top up using hydraulic oil with the same characteristics as those indicated in the table at paragraph 23.

The following lubricators have been centralized and gathered in a case (fig. 33a) positioned on the base (crane distributor side):

- rack guide shoe - rotation,
- upper and lower bush of the column - column support,
- rack group - column gear,
- column support group - pendulum beam.

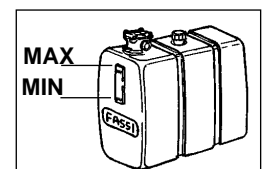

fig. 33

### (!) WARNING (!)

At low temperatures, the grease shall not crystallize or, to be more precise, shall not change its characteristics. At the effective operative temperature, the grease we recommend shall have a fluidity at least equal to rating **NLGI 0** or max. 1.

### (!) WARNING (!)

**Centralized lubrication shall not be used when room temperature is below -10°C / -20°C.**

All the lubricators mounted on the crane are protected by a plastic cap so to avoid the oil contamination.

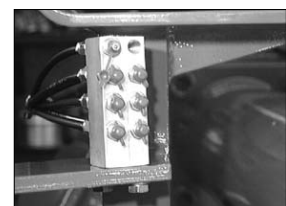
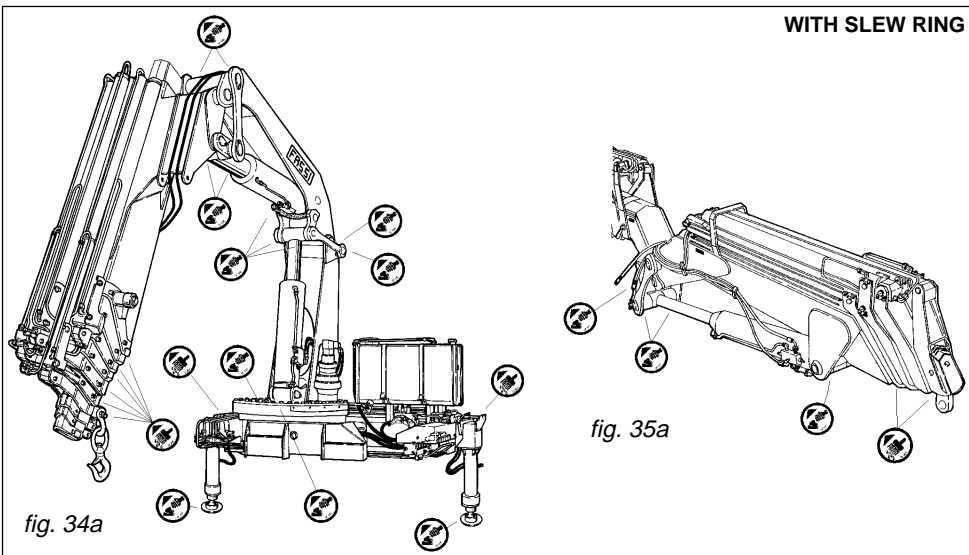
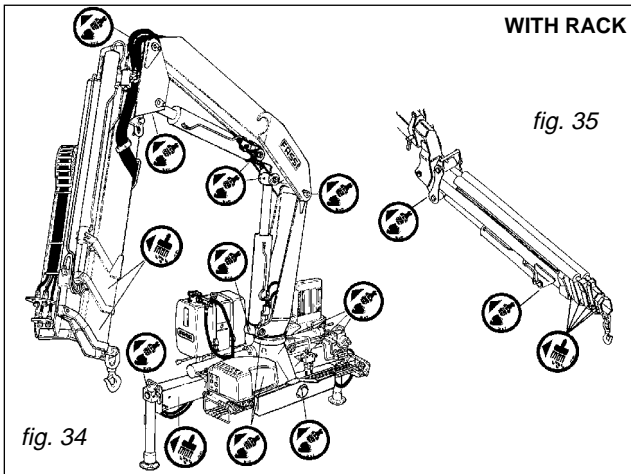

fig. 33a

## 22.5 After every 100 working hours or more frequently in case of more intensive utilisation

### WITH RACK

Periodically grease the points indicated on the crane (fig. 34) (and on the hydraulic jib, when fitted, fig. 35) paying particular attention to the points not easily detected. For the sliding sections of the outrigger supports and of the extension booms guide shoes made from a special material have been fitted: to ease their movement it is recommended to smear a light film of grease on them, taking care that the surfaces of the extension booms are free from impurities such as sand etc. Top up using hydraulic oil with the same characteristics as those indicated in the table at paragraph 23.



### WITH SLEW RING

Grease the slew gear to prevent friction during rotation and to ensure that it is stable by preventing water (corrosion protection) and contaminants from entering the bearings. For a better internal distribution of the grease it is advisable

to rotate the crane and grease it in such a way as to see grease at the seals. Top up using hydraulic oil with the same characteristics as those indicated in the table at paragraph 23. Grease the winch cable (if fitted) after having first cleaned the cable of any encrustation (grease mixed with sand, dust, dirt etc.) The lubricant used must guarantee a good level of penetration in order to lubricate both the inside and the outside of the cable. Top up using hydraulic oil with the same characteristics as those indicated in the table at paragraph 23.

## 22.6 After every 500 working hours or after every 6 working months

Check the tightening torque:

- of the fixing rods of the crane; consult the following table in order to find its value according to the bolt diameter:

*Table of the tightening torques of the fixing rods of the crane on the vehicle  
From "C0404 Kit for crane fixing".*

D. Fixing rods	Tightening torque = Nm
M22x1,5	300
M24x2,0	400
M27x2,0	600
M30x2,0	471
M33x2,0	1200
M39x3,0	1800

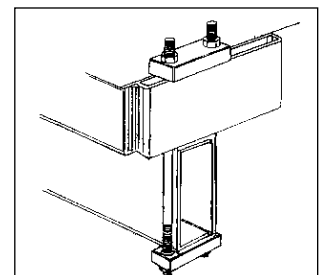

**WITH SLEW RING**

- of the slew gear screws (bolts M20 Class 12.9: Tightening torque = 620 Nm)

**WITH RACK**

- of the securing bolts for the ram pins and of all the other bolts and screws, where the tightening torque is not expressly indicated, consult the following table in order to find it's value according to the bolt diameter and class.

Table of the bolts tightening torque, in general, with average friction value (0,15) and average-good tightening accuracy (C).

From ... "ELEMENTS DE FIXATION - ASSEMBLAGES VISSES" (AFNOR E 25-030 1984)

Diameter Bolt = D	Class 8.8 Torque = Nm	Class 10.9 Torque = Nm	Class 12.9 Torque = Nm
3	1,06	1,56	1,83
4	2,44	3,58	4,19
5	4,83	7,10	8,30
6	8,30	12,30	14,30
8	20	29	35
10	40	59	69
12	69	102	119
14	111	163	191
16	173	255	298
18	239	352	412
20	339	499	584
22	466	685	802
24	584	858	1004
27	865	1271	1487
30	1173	1723	2016
33	1594	2342	2740
36	2046	3006	3517
39	2658	3905	4570

**WITH SLEW RING**

Check the rotation control motoreducer oil level. Fig. 34

- Remove the bleed plug (1) using a 22 mm Allen wrench.
- Remove the plug (2) using an 8 mm Allen wrench and the O-ring.
- Top up, if necessary, with the same type of oil as indicated in the table at Paragraph 23 via the mouth (bleed plug).
- The correct level is reached when oil starts to escape from the threaded hole in plug (2).
- Check the state of wear of the O-rings (replace if necessary) and then return the plugs. The lubrication oil can be drained completely by removing plug (3) using an 8 mm Allen wrench.

Check the guide shoe wear as it affects the sliding section tolerances; if the clearances are considerable, damage to the rams and the structure may occur.

Clean the air filter placed in the top of the oil tank filter cap.

Completely replace the hydraulic oil and the filter cartridges.

**(!) The waste oil and the filter cartridges MUST be disposed of by authorized persons.**

**(!) CAUTION DANGER (!)**

On the outer boom there is a mercury capsule (mercury level switch) duly protected and provided with the following warning stickers.

**MERCURY IS EXTREMELY TOXIC. IN CASE OF REPLACEMENT AND/OR SCRAPPING, DISPOSE OF OR RECYCLE THE CAPSULE CONTAINING MERCURY WITH MAXIMUM CARE, AND IN ACCORDANCE WITH THE NATIONAL REGULATIONS IN FORCE.**

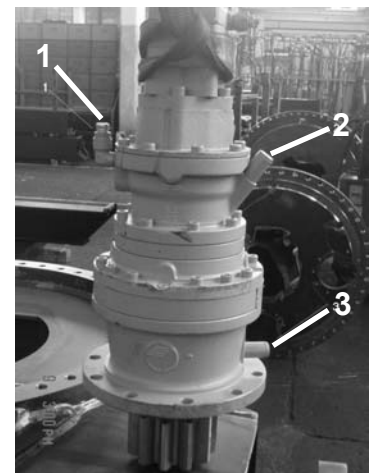

fig. 34

**Contiene mercurio: smaltire secondo le leggi in vigore**

Hg

**Es hat quecksilber: bitte beseitigen so wie gesetzlich**

**Mercury inside: scrap following laws in force**

**Contient du mercure: recycler selon les lois en vigueur**

## 22.7 After every 1000 working hours or after every working year

Perform: Washing, Function Testing, Testing according to the capacity plates

Check: Identification plates, Capacity plates

Checklist in accordance with ISO 9927-1

Element	Checks to be carried out:
Subframe Structure and fixing rods	Tightening torque of the fixing rods, wear and any deformation, actions
<i>For crane with rack:</i> Base Rack group, compensator	Lubrication, tightening torque of the rods, wear and any deformation, actions
<i>For crane with slew ring:</i> Base Slew ring group, compensator	Lubrication, tightening torque of the screws wear and any deformation, actions
Outriggers Supports, rams, base plates safety catches, hoses	Greasing of extension supports, oil-leaks, wear, actions, inspection of hoses
Rotation cylinders Cylinders, pistons, seals,	Oil-leaks, chromium plating, any deformation, inspection of hoses
Column Inner boom connection, outrigger connection, pins, bushes	Lubrication, wear and any deformation, actions
Inner boom Pins, outrigger connections	Lubrication, wear and any deformation, actions
Inner ram Cylinder, rod, piston, seals, hoses	Oil-leaks, chromium plating, any deformation, inspection of hoses
Outer boom Pins, outrigger connections	Lubrication, wear and any deformation, actions
Outer ram Cylinder, rod, piston, seals, hoses	Oil-leaks, chromium plating, strains, inspection of hoses
Extension booms Guide shoes, pins, outrigger connections	Lubrication, wear and any deformation, actions
Extension rams Cylinder, rod, piston, seals, hoses	Oil-leaks, chromium plating, any deformation, inspection of hoses
Hydraulic jib Booms, pins, outrigger connections	Lubrication, wear and any deformation, actions
Rams (hydraulic jib): Cylinder, rod, piston, seals, hoses	Oil-leaks, chromium plating, any deformation, inspection of hoses
Winch Torque limiter, brake, rope slide guide, cable, stroke end, pulleys	Lubrication, wear and any deformation, actions
Distributors, deviators, valves Control levers, forks, joints, fixing screws, lead seals	Checking of the pressure, oil-leaks, wear and any deformation, actions,
Lifting moment limiting device Valves, pressure switches, electrovalves	Checking of the pressure, oil-leaks
Power take-off, pump, oil-tank Filters, hoses	Pump capacity, checking of the pressure, oil change, replacement of filters, inspection of hoses



Oil-pressure system Hoses, hose protection devices	Checking of the pressure, oil-leaks, inspection of hoses
Implements for lifting Hooks, chains, cables, slings	Safety check, wear and any deformation, actions
Implements Wallboard forks, buckets, rotators	Oil-leaks, wear and any deformation, actions, inspection of hoses
Seat, third control station Frame, fixing screws	Access inspection, wear and any deformation, strains
Tele(radio)remote control	Test

## 22.8 Complete overhaul of the crane is required when 10.000 working hours or 10 years' life are reached - i.e.:

When one of the limits indicated hereunder is reached:

**10.000 working hours**, (i.e.: 10 years, 50 weeks a year, 20 hours a week, or 5 years, 50 weeks a year, 40 hours a week)

or

**10 years' life of the crane**,

a complete overhaul with in-depth structural inspection of the crane must be carried out by the Manufacturer or by an authorised service centre.

## 22.9 Instructions for the dismantlement and the demolition of a FASSI crane

### INSTRUCTIONS FOR THE DISMANTLEMENT AND THE DEMOLITION OF A FASSI CRANE

In case of demolition it is necessary to dismantle the whole machine and separate the different types of materials according to the respective waste disposals requirements.

The materials involved are the following:

- Ferrous materials: fabrications and mechanical components.
- Plastic materials: gaskets, belts, covers.
- Electric materials: windings, controls, electrovalves and similar.
- Oils and lubricants: hydraulic oil, lubricants for reducers, lubricating greases.
- For the truck follow the indications of the manufacturer
- Different material: Mercury (level sensor)

Take extreme care when slinging the components to be disassembled especially with respect to their weight.

Completely release the residual pressure in the hydraulic circuits and then fully drain the oil present in the circuits before starting the dismantlement of the relevant components. Be careful not to let the oil drop on the ground, therefore collect it in special containers, since exhausted oil must be eliminated in compliance with the waste disposal rules in force.

Disable all the electric power supplies (batteries etc.) before dismantling the components of the electric circuits.

## 23 TABLE OF HYDRAULIC OIL AND LUBRICANTS CHARACTERISTICS

<b>HYDRAULIC OIL WITH HIGH VISCOSITY: ISO-L-HV</b>		
Minimal external temperature: -35°C -20°C	maximal oil temperature: +45°C +75°C	Gradation ISO VG 32 ISO VG 46

<b>HYDRAULIC OIL WEAR RESISTANT: ISO-L-HM</b>		
Minimal external temperature: -10°C + 0°C + 5°C +10°C	maximal oil temperature: +60°C +75°C +85°C +90°C	Gradation ISO VG 32 ISO VG 46 ISO VG 68 ISO VG 100

<b>GREASE (for centralized system)</b>
Use only GREASE NILEX EP1 of the firm NILS. NOTE: Do not ABSOLUTELY mix different types of grease.

<b>GREASE (for slew ring, extension booms, outrigger supports...)</b>
-30°C up to +130°C      EP1 Gradation (cold climate) EP2 Gradation (warm climate)
All grease used must be free from acid and resin, not hygroscopic and long-life such as BP GREASE LTX-EP1\EP2 or ELF EPEXA 1\2 ESSO BEACON EP1\EP2 or TEXACO EP1\EP2 MOBIL EP1\EP2 or SIMILAR.

<b>HYDRAULIC OIL FOR MOTOREDUCER</b>
Classification ISO-L-CC  Gradation EP ISO-VG 150

<b>LUBRICATING OIL (for winch cable)</b>
The most suitable here is a general-purpose lubricating oil with about SAE 30° viscosity. A lubricating oil containing non-stick additives is recommended if the cables are expected to move quickly through the pulleys.  BRILUBE 50 (BRITISH ROPES - BRINDON)

### ( ! ) WARNING ( ! )

Don't use greases with solid particles as "Bisulphide of Molybdenum" (not compatible with eventual teflon bushes).

## 24.1 Generality

Many years experience of our product has allowed us to identify and classify the most common faults which occur. In most cases it requires accurate hydraulic and electric troubleshooting and simple rectification. In the following table we report the most frequent inconveniences and our suggested remedies.

(!) Checking and adjustment of oil pressures of valve settings must be carried out by an authorized service agent, under penalty of warranty forfeiture.

### (!) ATTENTION (!)

In the event that the crane ceases to operate and the code "alarm" with a number appears on the Display B. Call your **FASSI authorised service centre** reporting the Alarm number with the crane model and serial numbers. If the fault cannot be cleared follow the procedure in the chapter "Controls to operate the crane" and override the dump valve EVI.

THIS IS ONLY A TEMPORARY ACTION FOR EMERGENCIES, the crane should be taken to a **FASSI service centre** for repair as soon as possible.

TO OPERATE THE CRANE FOR TOO LONGER PERIOD WITH THE OVERRIDE ACTIVATED MAY INVALIDATE THE CRANE WARRANTY.

## 24.2 Only operations which can be carried out by the user

**Note:** Any operation, other than those indicated hereunder, must be performed only and exclusively by specialized personnel from an authorized support centre, considering the potential residual risks.

FAULTS	CAUSE	REMEDIES
The crane does not rotate properly	Vehicle non in level position Lack of lubrication	Stabilize the vehicle  - <i>WITH RACK:</i> Grease the bushes and the rotation guide shoe - <i>WITH SLEW RING:</i> Grease the slew ring and the pinion gear-slew ring group
The extension booms do not completely extend or work jerkily	Lack of lubrication of the guide shoes	Grease the guide shoes
Crane controls are not active	Lack of electric energy  Winch stroke end active (if fitted)  The rotation limiting device is activated	Check the fuse, the battery and electric circuit  See 21.2  See 16.6
Vibrations in crane operations	Shortage of oil  Obstructed filters	Check the level and top up if necessary  Clean or replace the filter cartridge
Noteable decrease in movement speed	Obstructed filters	Clean or replace the filter cartridge

## 24.3 Operations to be carried out only by an authorized service center

FAULTS	CAUSE	REMEDIES
The crane does not lift the loads indicated on the capacity plate	<p>Non efficiency of the pump</p> <p>(main pressure or auxiliary) valves not properly adjusted, or worn</p> <p>Ram seals are not properly fitted</p>	<p>Replace the pump</p> <p>Check the pressure, adjust the valves or replace them!</p> <p>Replace the seals</p>
A boom of the crane does not hold up the load and visually lowers	<p>The safety check valve the ram is open</p> <p>Oil leaks inside the ram</p>	<p>Replace the valve</p> <p>Defective seals, replace them!</p>
<p>The crane does not rotate properly</p> <p>- <u>WITH RACK</u>:</p> <p>- <u>WITH SLEW RING</u>:</p>	<p>Valves controlling the rotation not adjusted</p> <p>Wear of rotation guide shoe</p> <p>Wear of the seals of the rotation cylinder</p> <p>Wear of the slew ring</p> <p>Wear of the motoreducer group</p>	<p>Adjust the valves</p> <p>Replace the guide shoe</p> <p>Replace the seals</p> <p>Check the slew ring wear, replace if necessary</p> <p>Check the motoreducer group wear, replace if necessary</p>
The extension booms do not completely extend or work jerkily	Wear of guide shoes	Check the guide shoes wear, replace if necessary
Vibrations in crane operations	Non efficient pump	Check the pump
Noteable decrease in movement speed	Non efficient pump	Check the pump

**FASSI** GRU IDRAULICHE S.p.A.  
24021 ALBINO (BG) ITALIA - Via dei Carmelitani, 2  
Tel. + 39 35 77.64.00 - Fax + 39 35 75.50.20

**INSTRUCTIONS FOR SAFE USE OF THE CRANE**

- 1 Only authorized persons are permitted to operate the crane.
- 2 The crane must be used on firm, level ground.
- 3 Check that the vehicle hand brake is on and that the wheels are chocked.
- 4 Before operation make sure that:
  - no-one is within the working area of the crane;
  - the safety devices are in place and operative;
  - the minimum safe working distances from power lines are observed;
  - the load is correctly slung and hooked.
- 5 Stabilize the vehicle with the outriggers, making sure that:
  - the lateral supports are fully extended;
  - the wheels are in contact with the ground and the suspension is not completely unloaded.
- 6 Use the crane in accordance with the use and maintenance manual, making sure that:
  - the load and radius are within the maximum limits shown on the crane capacity plate;
  - the crane is used progressively avoiding sudden load movements;
  - swinging or dragging of the load is avoided;
  - the load is lifted before rotating.
- 7 When using implements protect the working area with a barrier.
- 8 The vehicle/crane are not left unless the power take off is disengaged and the load is on the ground.
- 9 Before driving the vehicle ensure that the outriggers are fully retracted and re-entered, the safety taps closed and the crane is in the folded position.

**DE 2499B**  
Instruction plate and safety norms

**FASSI** GRU IDRAULICHE

**ATTENZIONE:** PRIMA DI AZIONARE LA GRU E' OBBLIGATORIO METTERE IN OPERA GLI STABILIZZATORI.

**WARNING:** BEFORE OPERATING THE CRANE IT IS COMPULSORY TO EXTEND THE OUTRIGGERS.

**ATTENTION:** AVANT D'UTILISER LA GRUE IL EST OBLIGATOIRE DE METTRE EN FONCTION LES STABILISATEURS.

**ACHTUNG:** VOR INBETRIEBNAHME DES KRANS MUESSEN DIE ABSTUETZUNGEN AUSGEFAHREN.

**ATENCIÓN:** ANTES DE ACCIONAR LA GRÚA ES OBLIGATORIO ESTABILIZAR EL VEHÍCULO.

**ATENÇÃO:** ANTES DE UTILIZAR A GRUA É OBRIGATÓRIO COLOCAR EM FUNCIONAMENTO OS ESTABILIZADORES.

**DE2327**

**DE 2327**  
Warning plate to stabilize the vehicle before using the crane

**DE4452**

**DE 4452**  
Instruction plate to fold the crane into the rest condition

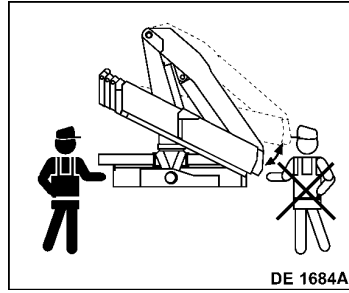

**DE 1684A**

Do not operate from the double control side, to unfold or fold the crane



**DE 4491**

Do not operate from the frontal position, to extend the outrigger supports



**DE 2100**

Danger plate for crushing of lower limbs



**DE 2696**

(STOP) plate

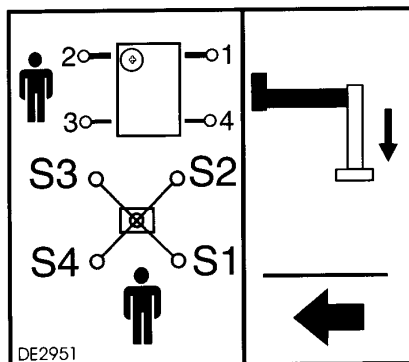

**DE 2951**

Instruction plates  
to stabilize the vehicle

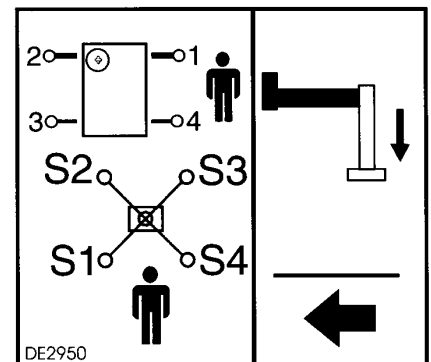

**DE 2950**



**DE 1681**  
Greasing points with brush

---



**DE 1682**  
Greasing points at pressure

---

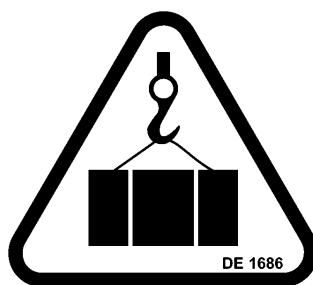

**DE 1686**  
Do not walk or stop under a suspended load

---

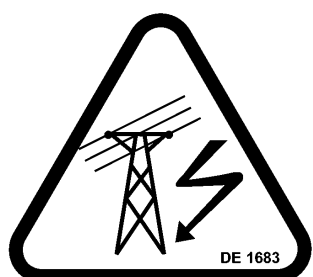

**DE 1683**  
Do not operate in proximity of electric high-tension lines

---

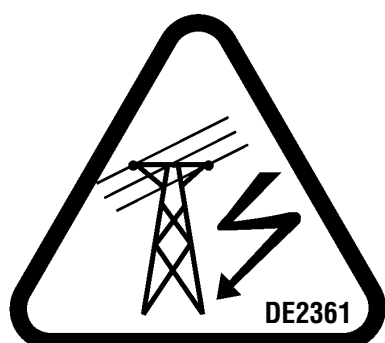

**DE 2361**  
Do not operate in proximity of electric high-tension lines

---

**DE 1679**

Do not walk on...

**DE 1680**

Do not use water to extinguish fire



DE1574

TIRANTI:	NON SALDARE!
FIXING ROD:	DO NOT WELD!
TIRANTS:	NE PAS SOUDER!
ZUGSCHRAUBEN:	NICHT SCHWEISSEN!

**DE 1574**

Do not weld the fixing rods



DE815

GHISA:	NON SALDARE!
CAST IRON:	DO NOT WELD!
FONTE:	NE PAS SOUDER!
GUSSEISEN:	NICHT SCHWEISSEN!

**DE 815**

Do not weld the cast iron