

Potain MD 365 B L16

Data Sheet

FEM 1.001-A3

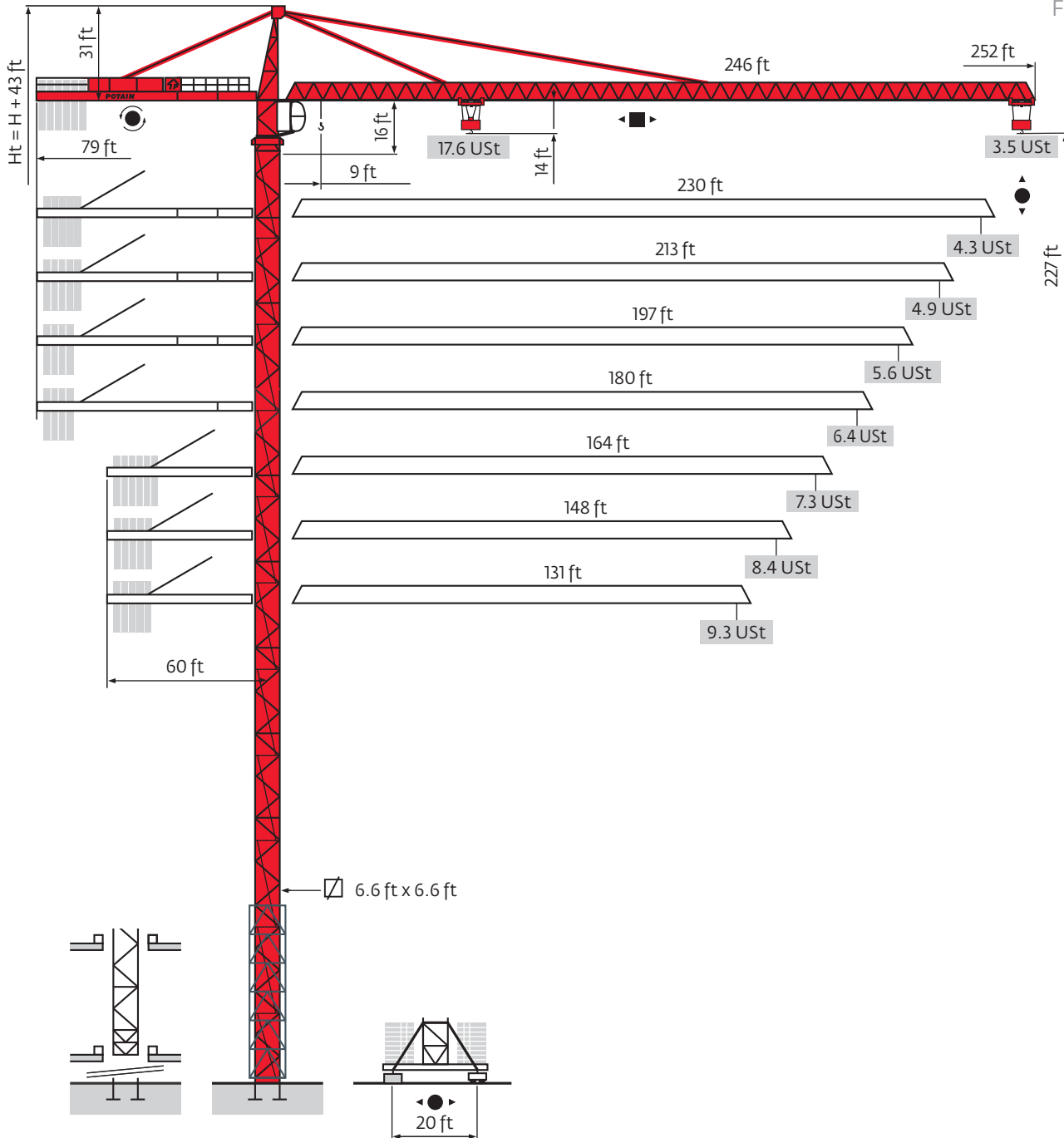

Values have been rounded

Mast

□ 6.6 ft
 ▴ 131 ft → 246 ft

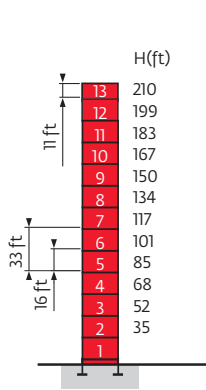

P 62 A

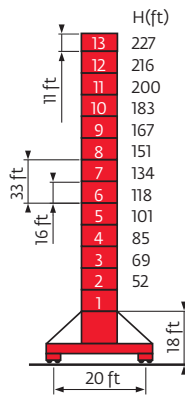

V 60 A

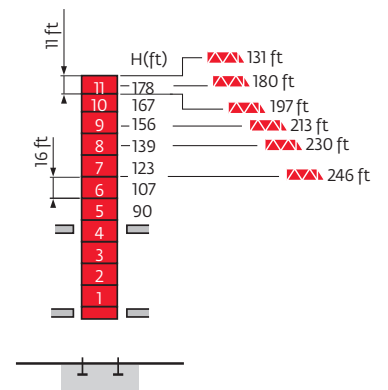

B 60 A

Climbing crane

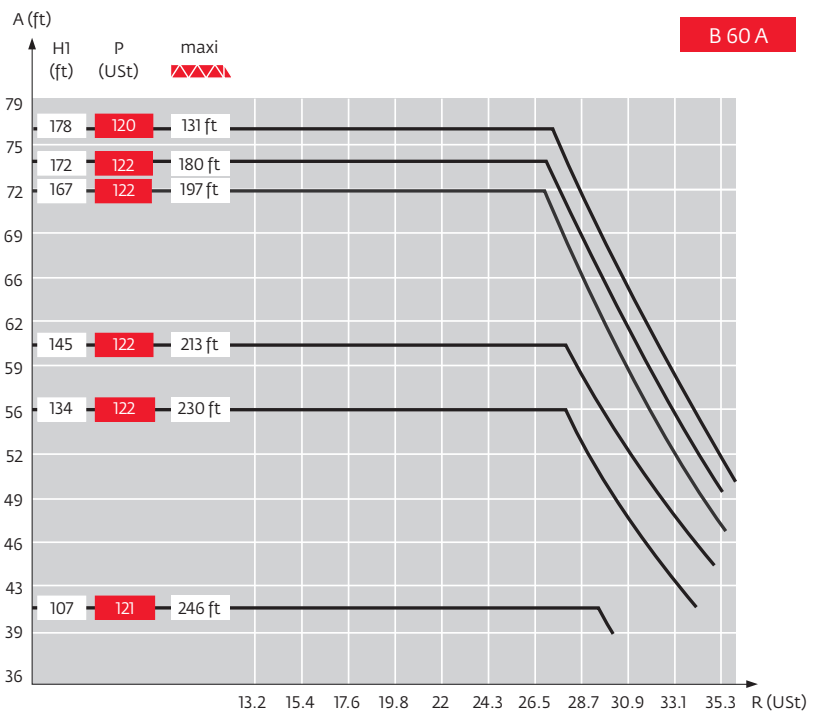
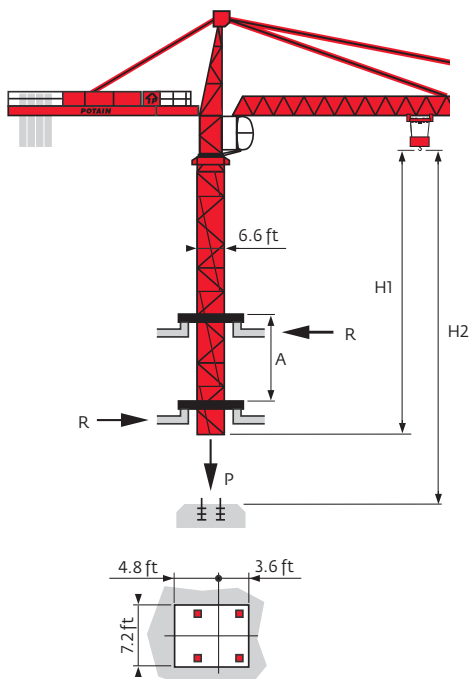

B 60 A

- Ht** Traveling maximum height
- A** Distance between collars
- H1** Crane height
- P** Crane weight (in service)
- R** Horizontal reaction

Load charts

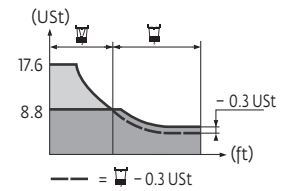
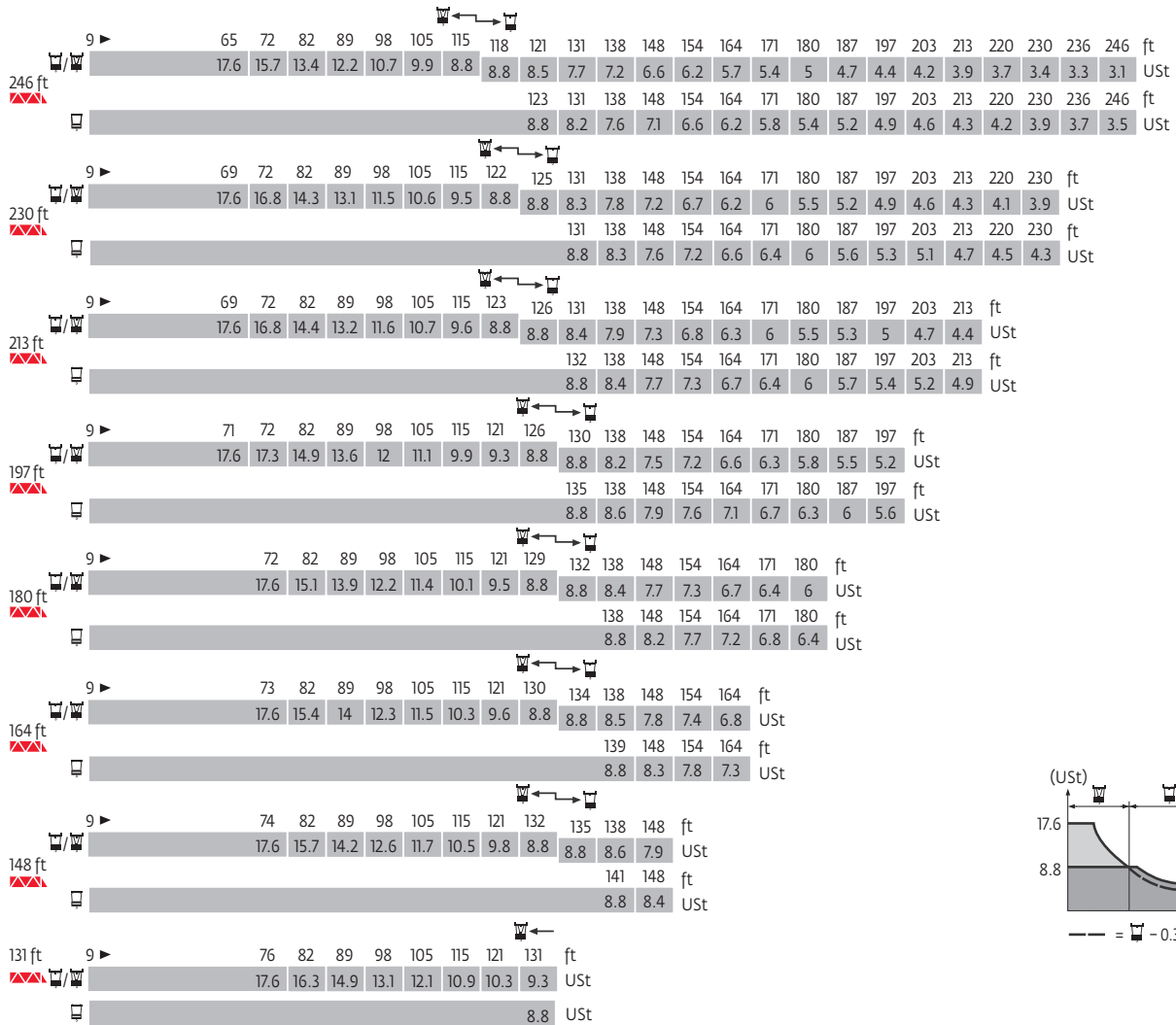

Counter-jib ballast



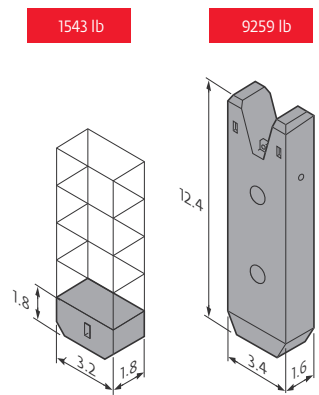







		75 LVF			100 LVF			150 LCC		
		9259 lb	1543 lb	(lb)	9259 lb	1543 lb	(lb)	9259 lb	1543 lb	(lb)
246 ft	79 ft	5	4	52,470	5	3	50,927	5	2	49,384
230 ft	79 ft	5	—	46,297	4	5	44,754	4	3	41,667
213 ft	79 ft	4	3	41,667	4	3	41,667	4	1	38,581
197 ft	79 ft	4	—	37,038	3	5	35,494	3	3	32,408
180 ft	79 ft	3	3	32,408	3	3	32,408	3	2	30,865
164 ft (B60A)	79 ft	3	2	30,865	3	1	30,203	3	—	27,778
164 ft	60 ft	5	5	54,013	5	4	52,470	5	3	50,927
148 ft	60 ft	5	—	46,297	4	5	44,754	4	4	43,211
131 ft	60 ft	4	2	40,124	4	1	38,581	4	—	37,038







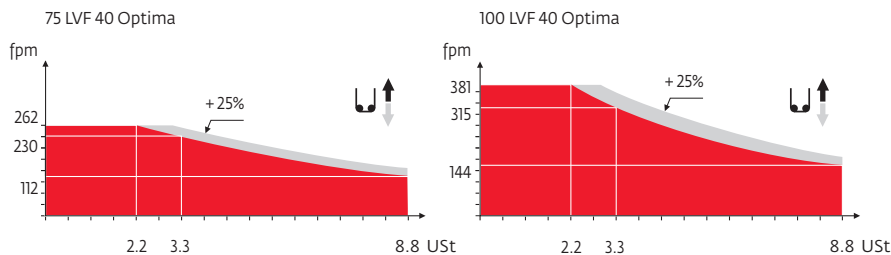

Base ballast

6.6 ft	V60 A	H (ft)	227	216	200	183	167	151	134	118	101	85	69	52
			(USt)	119	119	119	119	119	119	106	106	106	93	93

Mechanisms

										hp	kW												
	75 LVF40 Optima	fpm	0	-	112	-	144	-	230	-	262	0	-	56	-	72	-	115	-	131	75	55	1814 ft
		USt	8.8		6.6		3.3		2.2		17.6		13.2		6.6		4.4						
	100 LVF40 Optima	fpm	0	-	144	-	184	-	315	-	381	0	-	72	-	92	-	157	-	190	100	75	3310 ft
		USt	8.8		6.6		3.3		2.2		17.6		13.2		6.6		4.4						
	150 LCC 40	fpm	223	-	269	-	335	-	446	-	531	112	-	135	-	167	-	223	-	266	150	110	1955 ft
		USt	8.8		6.6		4.4		2.2		1.1		17.6		13.2		8.8		4.4				
	6 DVF 6	fpm	0-134 (17.6 USt) 0-276 (8.8 USt) 0-328 (4.4 USt)															5.5	4				
	RVF 182 Optima +	rpm	0 - 0.7															2 x 12	2 x 9				
	RT 544 A1 2V R ≥ 43 ft	fpm	52-105															4 x 8.4	4 x 6.2				
CEI 38				IEC 38																			
		480 V (+6% -10%) 60 Hz																75 LVF : 100 kVA 100 LVF : 125 kVA 150 LCC : 175 kVA					



-  Hoisting
-  Trolleying
-  Slewing
-  Traveling
-  Consult us

Constant improvement and engineering progress make it necessary that we reserve the right to make specification, equipment and price changes without notice. Illustrations shown may include optional equipment and accessories, and may not include all standard equipment.



www.manitowoc.com

Regional Headquarters

Americas

Manitowoc, Wisconsin, USA
 Tel: +1 920 684 6621
 Fax: +1 920 683 6277

Shady Grove, Pennsylvania, USA
 Tel: +1 717 597 8121
 Fax: +1 717 597 4062

Europe, Middle East, Africa

Ecully, France
 Tel: +33 472 18 2020
 Fax: +33 472 18 2000

Asia - Pacific

Shanghai, China
 Tel: +86 21 6457 0066
 Fax: +86 21 6457 4955

Potain MD 365 B L16
 Code 05-007-.5M-409