



**TRUCK CRANE  
ROADMASTER 9000**

90t capacity class

**DATASHEET - IMPERIAL**

**PRELIMINARY**

# ROADMASTER 9000

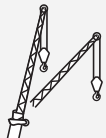
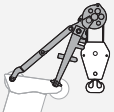

**WORKS FOR YOU.™**

	Page:
<b>Dimensions</b> .....	4
<b>Specifications</b> .....	6
<b>Counterweight</b> .....	7
 <b>Main boom</b> .....	8
 <b>Folding swing-away jib</b> .....	12
 <b>Boom head extension</b> .....	15
<b>Technical description</b> .....	18

	Counterweight		Workings speeds
	Lifting capacities on outriggers · 360°		Max. line pull
	Radius		Rope diameter
	Main boom		Rope length
	Swing-away jib		Hook block (capacity-sheaves-rope diameter)
	Boom head extension		Number of lines
	Max. axle loads		Possible load of hook block
	Mechanism		Weight of hook block
	Tires		Distance head sheave axle – hook ground
	Hook block		Number of sheaves in boom head
	Hoist		Supporting force
	Travel speed		Length of stroke (support cylinders)
	Gradeability – road %		
	Slewing		
	Boom telescoping		
	Boom elevation		

PRELIMINARY

# DIMENSIONS

# ROADMASTER 9000

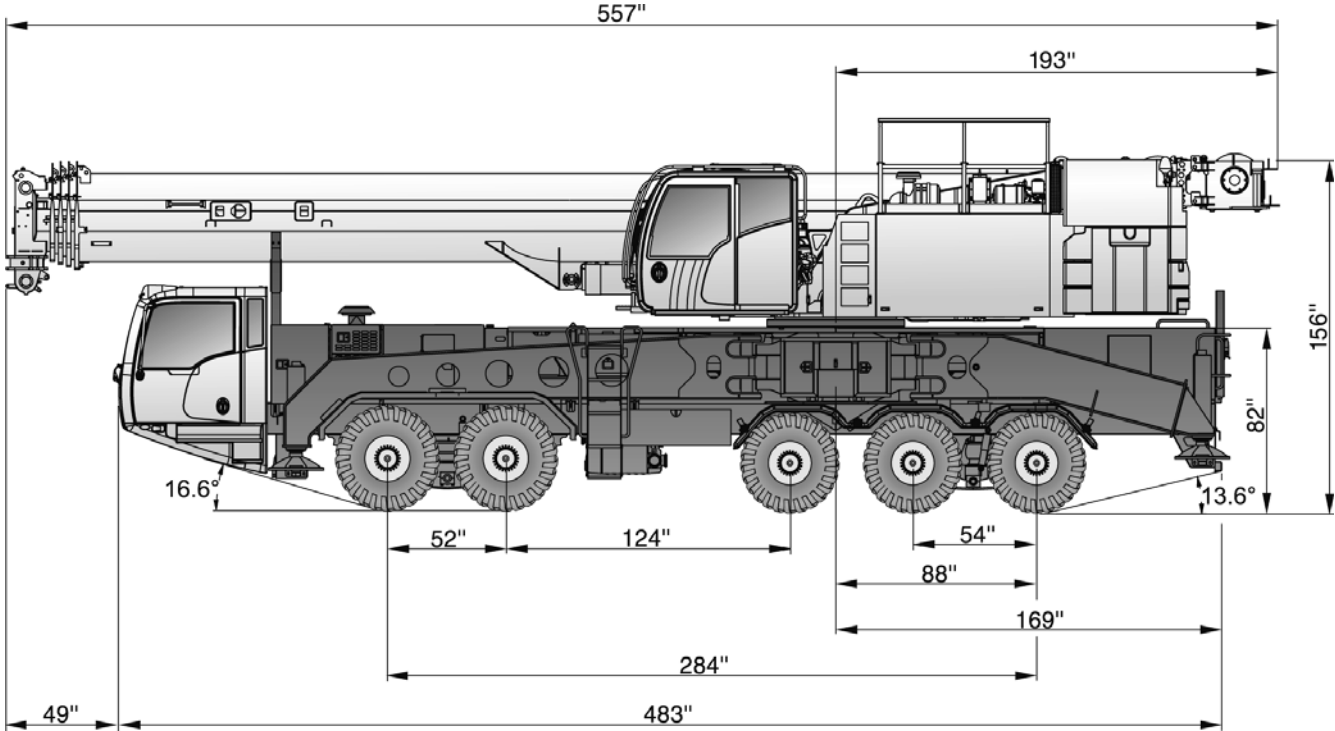

PRELIMINARY

# DIMENSIONS



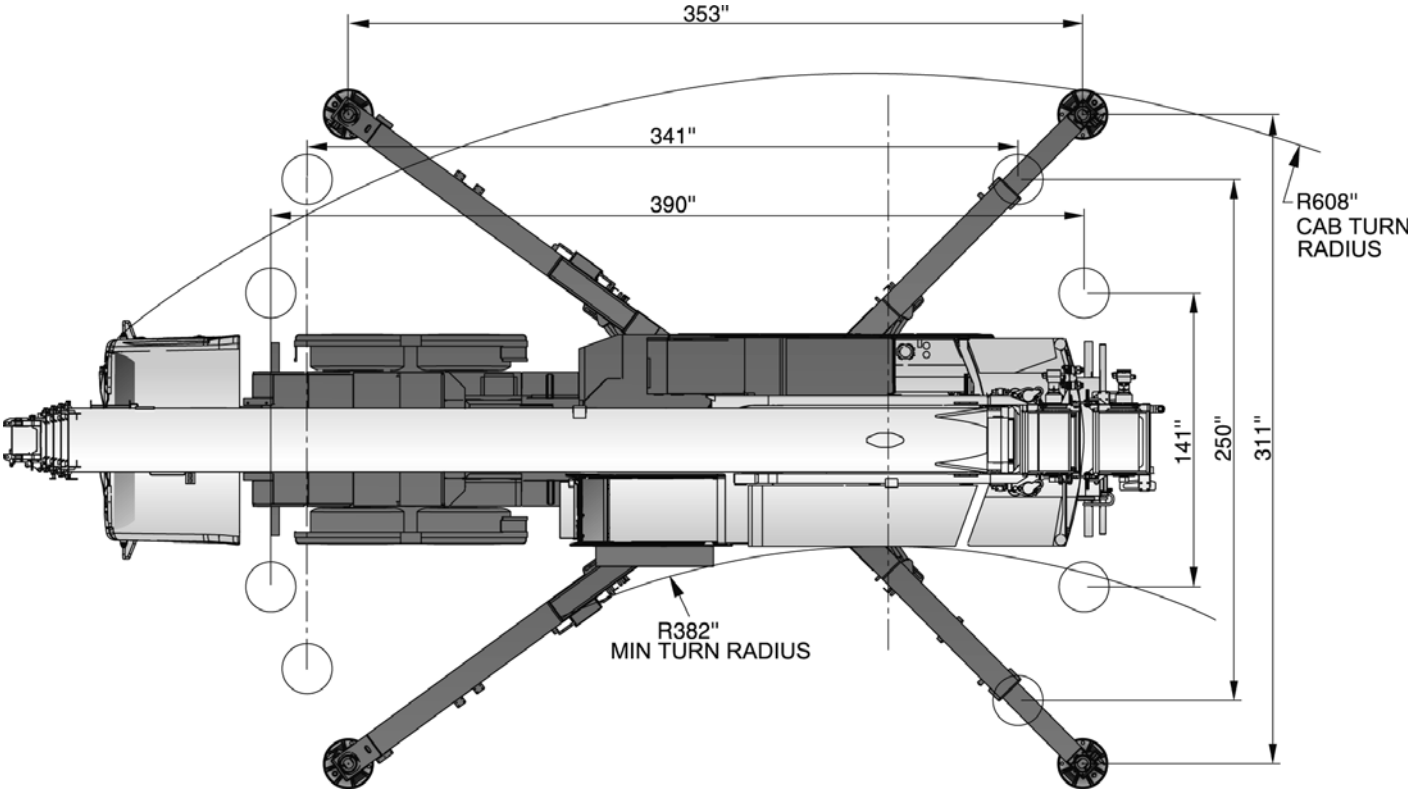

# ROADMASTER 9000







PRELIMINARY











# SPECIFICATIONS







# ROADMASTER 9000

 Axle 1 + Axle 2 + Axle 3 + Axle 4 + Axle 5	Total				 2
11.0T + 11.0T + 0T + 12.2T + 12.2T	46.4T	23-3-18	-	0	-
9.6T + 9.6T + 9.0T + 9.6T + 9.6T	47.4T	23-3-18	-	0	-
11.9T + 11.9T + 0T + 14.7T + 14.7T	53.1T	23-3-18	62.3 ft	5.17T	-
9.4T + 9.4T + 9.0T + 13.2T + 13.2T	54.2T	23-3-18	62.3 ft	5.17T	-
11.6T + 11.6T + 0T + 14.6T + 14.6T	52.3T	23-3-18	-	5.94T	-
9.8T + 9.8T + 9.0T + 13.2T + 13.2T	55.0T	23-3-18	-	5.94T	-
12.0T + 12.0T + 0T + 15.0T + 15.0T	53.9T	23-3-18	62.3 ft	5.94T	-
9.7T + 9.7T + 9.0T + 13.3T + 13.3T	55.0T	23-3-18	62.3 ft	5.94T	-
10.4T + 10.4T + 9.0T + 13.4T + 13.4T	56.6T	23-3-18	62.3 ft	7.59T	-
11.9T + 11.9T + 9.0T + 13.7T + 13.7T	60.1T	23-3-18	62.3 ft	11.11T	-

		65 mph	
23.9T	30.0T		29.1"
29.1"	29.1"		

	445/65R22.5, 315/80R22.5
	30 %

				
 1	377 ft/min	15062.2 lb	0.71"	869.4 ft
 2	377 ft/min	15062.2 lb	0.71"	869.4 ft
	1.4 min <sup>-1</sup>			
	315 s (39.0-164.0 ft)			
	60 s (0°-82°)			

					
1	7.4T	12.1-0	5	352.8 lb	3.28 ft
2	14.8T	29.8-3	5	1045.0 lb	5.91 ft
3	22.0T	29.8-3	5	1045.0 lb	5.91 ft
4	29.3T	29.8-3	5	1045.0 lb	5.91 ft
5	36.5T	75.0-5	5	1203.8 lb	5.91 ft
6	43.5T	75.0-5	5	1045.0 lb	5.91 ft
7	50.6T	75.0-5	5	1045.0 lb	5.91 ft
8	57.5T	75.0-5	5	1045.0 lb	6.56 ft
9	64.4T	75.0-5	5	1045.0 lb	6.56 ft
10	71.2T	75.0-5	5	1045.0 lb	6.56 ft
11	77.9T	99.2-7	5 + S1	2149.5 lb	6.56 ft
12	84.5T	99.2-7	6 + S1	2149.5 lb	6.56 ft
13	91.2T	99.2-7	7 + S1	2149.5 lb	6.56 ft
14	97.7T	99.2-7	8 + S1	2149.5 lb	6.56 ft

# COUNTERWEIGHT

# ROADMASTER 9000

## Parts

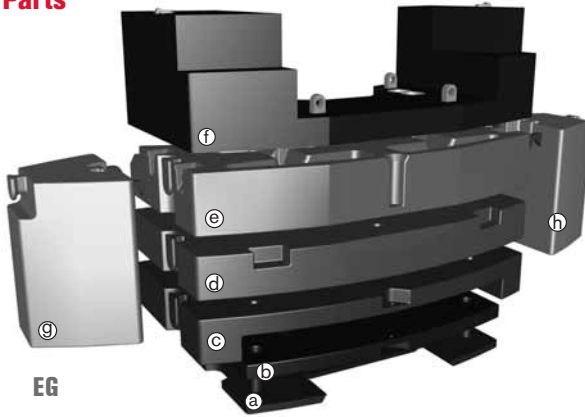

EG

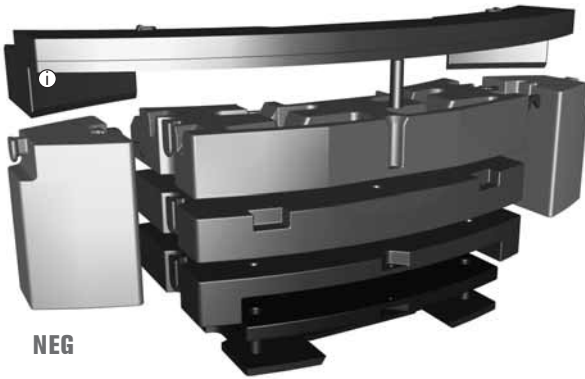

NEG

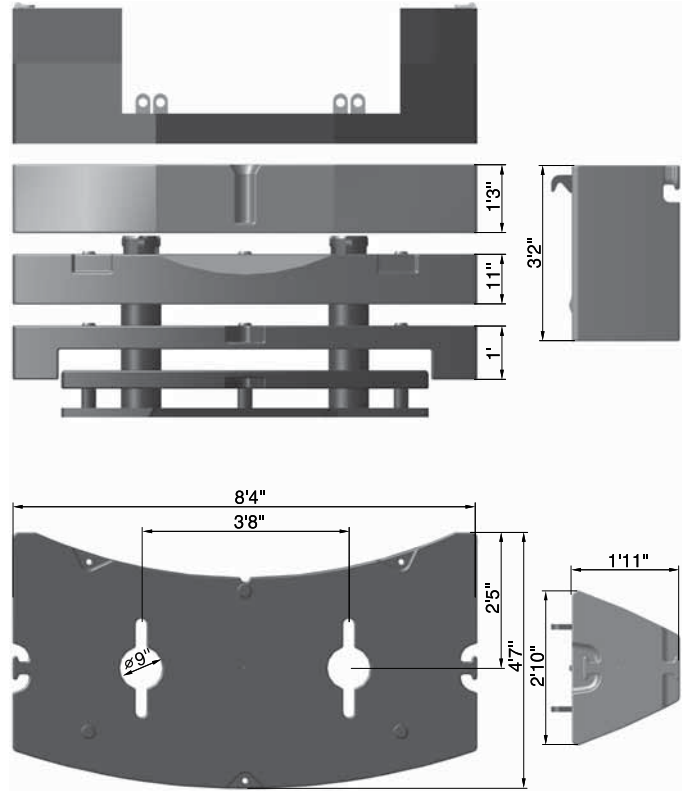

## Configurations

	EG	NEG	(a) 1,540 lb	(b) 3,310 lb	(c) 7,060 lb	(d) 11,470 lb	(e) 13,230 lb	(f) 10,360 lb	(g) 5,290 lb	(h) 5,290 lb	(i) 10,360 lb
1,540 lb	X	X	X								
4,850 lb	X	X	X	X							
8,600 lb	X	X	X		X						
10,360 lb	X							X			
11,900 lb	X		X					X			
11,900 lb	X	X	X	X	X						
15,200 lb	X		X	X				X			
19,000 lb	X		X		X			X			
20,000 lb	X	X	X		X	X					
22,300 lb	X		X	X	X			X			
23,400 lb	X	X	X	X	X	X					
30,400 lb	X		X		X	X		X			
33,300 lb	X	X	X		X	X	X				
33,700 lb	X		X	X	X	X		X			
36,400 lb	X	X	X	X	X	X	X				
43,700 lb	X		X		X	X	X	X			
43,900 lb	X	X	X		X	X	X		X	X	
47,000 lb	X		X	X	X	X	X	X			
47,200 lb	X	X	X	X	X	X	X		X	X	
54,200 lb	X		X		X	X	X	X	X	X	
54,200 lb		X	X		X	X	X		X	X	X
57,500 lb	X		X	X	X	X	X	X	X	X	
57,500 lb		X	X	X	X	X	X		X	X	X

PRELIMINARY

# MAIN BOOM

# ROADMASTER 9000

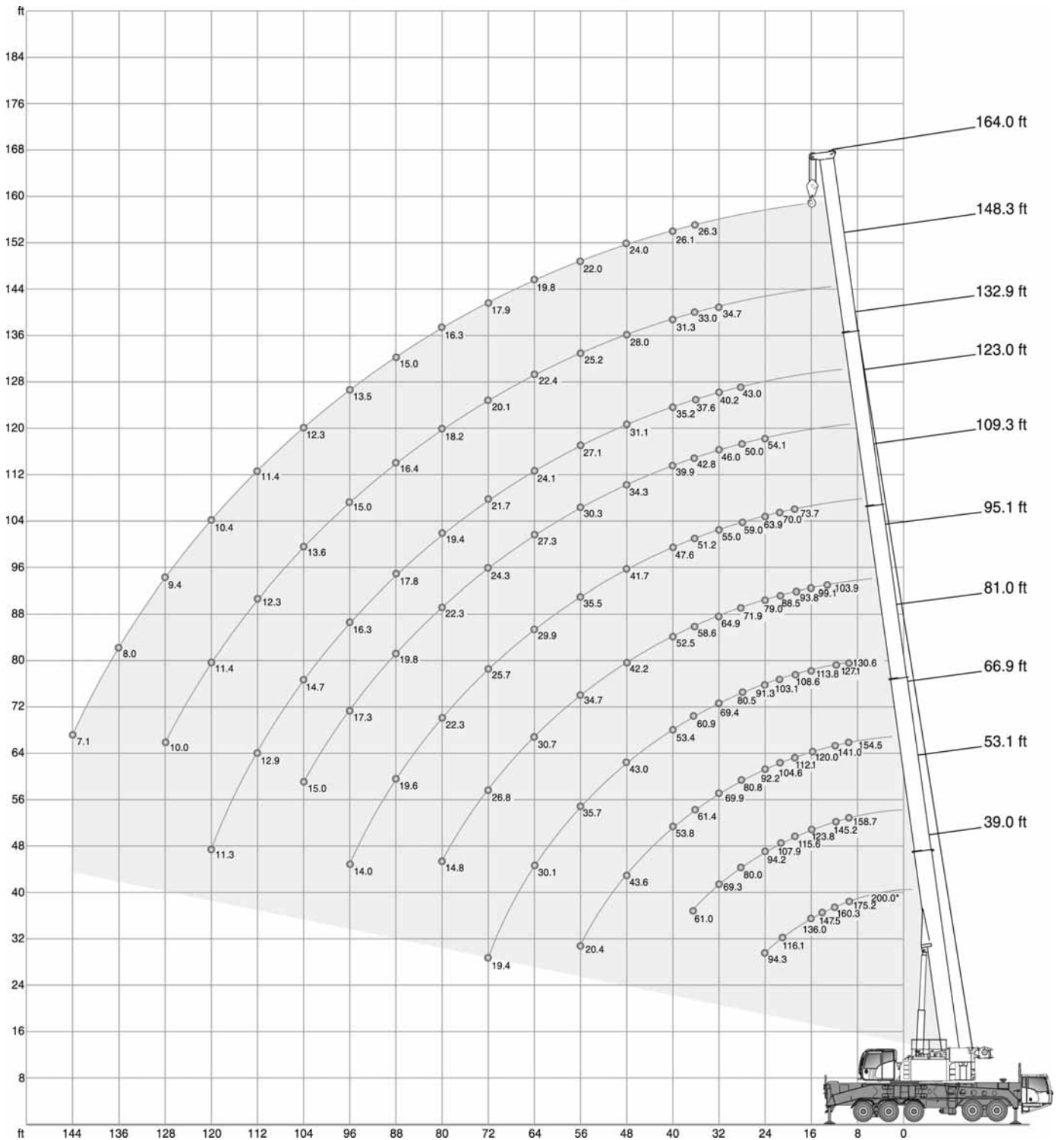
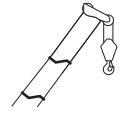



PRELIMINARY





# MAIN BOOM

# ROADMASTER 9000

57,500 lb		26 ft x 29 ft 6 in (100%)										360°	85 %
  (0°)		39.0 ft	39.0 ft	53.1 ft	66.9 ft	81.0 ft	95.1 ft	109.3 ft	123.0 ft	132.9 ft	148.3 ft	164.0 ft	
ft	180.0*	-	-	-	-	-	-	-	-	-	-	-	ft
1,000 lb													
10	175,2	164,2	158,7	154,5	130,6	-	-	-	-	-	-	-	10
12	160,3	150,1	145,2	141,0	127,1	-	-	-	-	-	-	-	12
14	147,5	137,9	133,7	129,7	118,3	103,9	-	-	-	-	-	-	14
16	136,0	127,3	123,8	120,0	113,8	99,1	-	-	-	-	-	-	16
18	126,1	118,0	115,6	112,1	108,6	93,8	73,7	-	-	-	-	-	18
20	116,1	109,1	107,9	104,6	103,1	88,5	70,0	-	-	-	-	-	20
24	94,3	91,8	94,2	92,2	91,3	79,0	63,9	54,1	-	-	-	-	24
28	-	-	80,0	80,8	80,5	71,9	59,0	50,0	43,0	-	-	-	28
32	-	-	69,3	69,9	69,4	64,9	55,0	46,0	40,2	34,7	-	-	32
36	-	-	61,0	61,4	60,9	58,6	51,2	42,8	37,6	33,0	26,3	-	36
40	-	-	-	53,8	53,4	52,5	47,6	39,9	35,2	31,3	26,1	-	40
48	-	-	-	43,6	43,0	42,2	41,7	34,3	31,1	28,0	24,0	-	48
56	-	-	-	20,4	35,7	34,7	35,5	30,3	27,1	25,2	22,0	-	56
64	-	-	-	-	30,1	30,7	29,9	27,3	24,1	22,4	19,8	-	64
72	-	-	-	-	19,4	26,8	25,7	24,3	21,7	20,1	17,9	-	72
80	-	-	-	-	-	14,8	22,3	22,3	19,4	18,2	16,3	-	80
88	-	-	-	-	-	-	19,6	19,8	17,8	16,4	15,0	-	88
96	-	-	-	-	-	-	14,0	17,3	16,3	15,0	13,5	-	96
104	-	-	-	-	-	-	-	15,0	14,7	13,6	12,3	-	104
112	-	-	-	-	-	-	-	-	12,9	12,3	11,4	-	112
120	-	-	-	-	-	-	-	-	11,3	11,4	10,4	-	120
128	-	-	-	-	-	-	-	-	-	10,0	9,4	-	128
136	-	-	-	-	-	-	-	-	-	-	8,0	-	136
144	-	-	-	-	-	-	-	-	-	-	7,1	-	144



\* with special attachment



47,000 lb		26 ft x 29 ft 6 in (100%)										360°	85 %
 		39.0 ft	53.1 ft	66.9 ft	81.0 ft	95.1 ft	109.3 ft	123.0 ft	132.9 ft	148.3 ft	164.0 ft		
ft												ft	
1,000 lb													
10	164,2	158,7	154,5	130,6	-	-	-	-	-	-	-	-	10
12	150,1	145,2	141,0	127,1	-	-	-	-	-	-	-	-	12
14	137,9	133,7	129,7	118,3	103,9	-	-	-	-	-	-	-	14
16	127,3	123,8	120,0	113,8	99,1	-	-	-	-	-	-	-	16
18	118,0	115,6	112,1	108,6	93,8	73,7	-	-	-	-	-	-	18
20	108,9	107,6	104,6	103,1	88,5	70,0	-	-	-	-	-	-	20
24	90,1	91,4	91,0	90,5	79,0	63,9	54,1	-	-	-	-	-	24
28	-	76,4	77,9	77,5	71,9	59,0	50,0	43,0	-	-	-	-	28
32	-	66,2	66,7	66,2	64,7	55,0	46,0	40,2	34,7	-	-	-	32
36	-	58,1	58,6	58,1	57,2	51,2	42,8	37,6	33,0	26,3	-	-	36
40	-	-	51,4	51,0	49,9	47,6	39,9	35,2	31,3	26,1	-	-	40
48	-	-	41,4	41,0	40,1	41,0	34,3	31,1	28,0	24,0	-	-	48
56	-	-	20,4	33,9	33,9	33,9	30,3	27,1	25,2	22,0	-	-	56
64	-	-	-	28,5	29,4	28,4	27,3	24,1	22,4	19,8	-	-	64
72	-	-	-	19,4	24,8	23,5	23,9	21,7	20,1	17,9	-	-	72
80	-	-	-	-	14,8	20,0	20,0	19,3	18,2	16,3	-	-	80
88	-	-	-	-	-	18,1	17,0	17,0	16,2	15,0	-	-	88
96	-	-	-	-	-	14,0	15,0	14,5	14,2	13,5	-	-	96
104	-	-	-	-	-	-	13,2	12,4	12,6	11,9	-	-	104
112	-	-	-	-	-	-	-	11,2	10,7	10,1	-	-	112
120	-	-	-	-	-	-	-	9,2	9,4	8,7	-	-	120
128	-	-	-	-	-	-	-	-	8,0	7,4	-	-	128
136	-	-	-	-	-	-	-	-	-	6,2	-	-	136
144	-	-	-	-	-	-	-	-	-	5,3	-	-	144

PRELIMINARY

# MAIN BOOM

# ROADMASTER 9000

☰ 33,700 lb		☰ 26 ft x 29 ft 6 in (100%)										360°		85 %	
 		39.0 ft	53.1 ft	66.9 ft	81.0 ft	95.1 ft	109.3 ft	123.0 ft	132.9 ft	148.3 ft	164.0 ft				
ft		1,000 lb										ft			
10	164,2	158,7	154,5	130,6	-	-	-	-	-	-	-	10			
12	150,1	145,2	141,0	127,1	-	-	-	-	-	-	-	12			
14	137,9	133,7	129,7	118,3	103,9	-	-	-	-	-	-	14			
16	127,3	123,8	120,0	113,8	99,1	-	-	-	-	-	-	16			
18	116,0	115,0	112,1	108,6	93,8	73,7	-	-	-	-	-	18			
20	104,6	105,9	104,1	102,8	88,5	70,0	-	-	-	-	-	20			
24	84,6	86,1	87,6	87,2	79,0	63,9	54,1	-	-	-	-	24			
28	-	72,8	73,4	73,0	70,8	59,0	50,0	43,0	-	-	-	28			
32	-	62,3	62,8	62,4	61,3	55,0	46,0	40,2	34,7	-	-	32			
36	-	54,7	55,1	54,6	53,6	51,2	42,8	37,6	33,0	26,3	-	36			
40	-	-	48,2	47,7	46,8	47,3	39,9	35,2	31,3	26,1	40	40			
48	-	-	38,4	37,9	38,2	37,8	34,0	31,1	28,0	24,0	48	48			
56	-	-	20,4	30,0	30,8	29,3	29,3	26,9	25,2	22,0	56	56			
64	-	-	-	25,1	24,7	24,5	23,8	23,1	22,4	19,8	64	64			
72	-	-	-	19,4	20,8	20,4	19,9	19,3	18,8	17,9	72	72			
80	-	-	-	-	14,8	17,2	16,8	15,9	16,1	15,5	80	80			
88	-	-	-	-	-	14,7	14,2	14,1	13,5	12,9	88	88			
96	-	-	-	-	-	12,7	12,0	12,3	11,2	10,6	96	96			
104	-	-	-	-	-	-	10,3	10,4	9,5	8,8	104	104			
112	-	-	-	-	-	-	-	9,0	7,9	7,2	112	112			
120	-	-	-	-	-	-	-	6,6	6,6	5,9	120	120			
128	-	-	-	-	-	-	-	-	5,5	4,8	128	128			
136	-	-	-	-	-	-	-	-	-	3,9	136	136			
144	-	-	-	-	-	-	-	-	-	3,1	144	144			

☰ 22,300 lb		☰ 26 ft x 29 ft 6 in (100%)										360°		85 %	
 		39.0 ft	53.1 ft	66.9 ft	81.0 ft	95.1 ft	109.3 ft	123.0 ft	132.9 ft	148.3 ft	164.0 ft				
ft		1,000 lb										ft			
10	164,2	158,7	154,5	130,6	-	-	-	-	-	-	-	10			
12	150,1	145,2	141,0	127,1	-	-	-	-	-	-	-	12			
14	137,9	133,7	129,7	118,3	103,9	-	-	-	-	-	-	14			
16	127,0	123,8	120,0	113,8	99,1	-	-	-	-	-	-	16			
18	113,2	112,5	110,5	108,5	93,8	73,7	-	-	-	-	-	18			
20	99,4	100,9	100,7	102,2	88,5	70,0	-	-	-	-	-	20			
24	80,4	82,9	83,4	82,9	78,5	63,9	54,1	-	-	-	-	24			
28	-	69,2	69,8	69,2	68,4	59,0	50,0	43,0	-	-	-	28			
32	-	59,2	59,6	59,2	58,1	55,0	46,0	40,2	34,7	-	-	32			
36	-	51,3	51,9	51,3	50,0	49,7	42,8	37,6	33,0	26,3	-	36			
40	-	-	44,6	43,9	44,1	43,9	39,6	35,2	31,3	26,1	40	40			
48	-	-	33,1	33,5	33,4	31,9	32,5	30,0	28,0	24,0	48	48			
56	-	-	20,4	26,4	25,7	25,9	25,0	24,7	23,9	22,0	56	56			
64	-	-	-	21,0	21,3	20,6	20,4	19,7	19,5	18,8	64	64			
72	-	-	-	17,5	17,3	17,0	16,4	16,6	15,7	15,1	72	72			
80	-	-	-	-	14,7	14,2	13,7	13,7	12,8	12,2	80	80			
88	-	-	-	-	-	11,8	11,3	11,4	10,5	9,9	88	88			
96	-	-	-	-	-	10,0	9,4	9,5	8,5	7,8	96	96			
104	-	-	-	-	-	-	7,7	7,9	7,0	6,3	104	104			
112	-	-	-	-	-	-	-	6,6	5,7	5,0	112	112			
120	-	-	-	-	-	-	-	4,4	4,6	3,9	120	120			
128	-	-	-	-	-	-	-	-	3,6	3,0	128	128			
136	-	-	-	-	-	-	-	-	-	2,2	136	136			

# MAIN BOOM

# ROADMASTER 9000

15,200 lb		26 ft x 29 ft 6 in (100%)										360°	85 %
		39.0 ft	53.1 ft	66.9 ft	81.0 ft	95.1 ft	109.3 ft	123.0 ft	132.9 ft	148.3 ft	164.0 ft		
ft		1,000 lb										ft	
10	164,2	158,7	154,5	130,6	-	-	-	-	-	-	-	10	
12	150,1	145,2	141,0	127,1	-	-	-	-	-	-	-	12	
14	137,9	133,7	129,7	118,3	103,9	-	-	-	-	-	-	14	
16	124,0	123,8	120,0	113,8	99,1	-	-	-	-	-	-	16	
18	109,5	110,8	108,7	106,8	93,8	73,7	-	-	-	-	-	18	
20	95,9	97,4	99,2	98,7	88,5	70,0	-	-	-	-	-	20	
24	77,6	80,0	80,6	80,2	77,7	63,9	54,1	-	-	-	-	24	
28	-	66,9	67,4	66,9	65,7	59,0	50,0	43,0	-	-	-	28	
32	-	57,1	57,6	57,1	54,5	53,0	46,0	40,2	34,7	-	-	32	
36	-	47,7	48,3	47,7	46,0	45,7	40,8	37,3	33,0	26,3	-	36	
40	-	-	39,4	40,1	40,3	38,6	37,8	34,1	31,2	26,1	40		
48	-	-	29,7	30,0	29,4	29,7	28,6	27,8	26,2	23,8	48		
56	-	-	20,4	23,1	23,3	22,7	22,4	21,6	21,5	20,1	56		
64	-	-	-	18,5	18,5	18,3	17,6	17,8	16,9	15,8	64		
72	-	-	-	15,1	15,3	14,6	14,2	14,4	13,3	12,6	72		
80	-	-	-	-	12,7	12,0	11,5	11,6	10,6	10,0	80		
88	-	-	-	-	-	9,9	9,3	9,5	8,4	7,7	88		
96	-	-	-	-	-	8,2	7,5	7,8	6,7	6,0	96		
104	-	-	-	-	-	-	6,1	6,3	5,2	4,6	104		
112	-	-	-	-	-	-	-	5,0	4,1	3,5	112		
120	-	-	-	-	-	-	-	3,1	3,1	2,5	120		
128	-	-	-	-	-	-	-	-	2,3	-	128		

11,900 lb		26 ft x 29 ft 6 in (100%)										360°	85 %
		39.0 ft	53.1 ft	66.9 ft	81.0 ft	95.1 ft	109.3 ft	123.0 ft	132.9 ft	148.3 ft	164.0 ft		
ft		1,000 lb										ft	
10	164,2	158,7	154,5	130,6	-	-	-	-	-	-	-	10	
12	150,1	145,2	141,0	127,1	-	-	-	-	-	-	-	12	
14	137,9	133,7	129,7	118,3	103,9	-	-	-	-	-	-	14	
16	122,5	122,7	120,0	113,8	99,1	-	-	-	-	-	-	16	
18	107,7	109,2	108,0	106,0	93,8	73,7	-	-	-	-	-	18	
20	94,4	95,9	97,7	97,2	88,5	70,0	-	-	-	-	-	20	
24	76,3	78,8	79,4	78,9	77,0	63,9	54,1	-	-	-	-	24	
28	-	65,8	66,3	65,8	62,7	58,5	50,0	43,0	-	-	-	28	
32	-	54,5	55,3	54,7	51,6	50,5	44,7	40,2	34,7	-	-	32	
36	-	45,0	45,7	45,1	44,8	42,9	39,7	36,1	33,0	26,3	-	36	
40	-	-	38,4	38,6	37,9	36,4	35,4	32,7	31,0	26,1	40		
48	-	-	28,0	28,2	28,5	27,8	27,5	25,9	25,1	23,2	48		
56	-	-	20,4	21,9	21,8	21,5	20,8	20,8	19,9	18,5	56		
64	-	-	-	17,3	17,3	16,9	16,2	16,5	15,6	14,4	64		
72	-	-	-	14,0	14,2	13,5	13,1	13,3	12,2	11,3	72		
80	-	-	-	-	11,6	11,1	10,5	10,7	9,6	8,9	80		
88	-	-	-	-	-	9,1	8,4	8,6	7,6	7,0	88		
96	-	-	-	-	-	7,3	6,8	6,9	6,0	5,3	96		
104	-	-	-	-	-	-	5,5	5,5	4,6	3,9	104		
112	-	-	-	-	-	-	-	4,4	3,5	2,8	112		
120	-	-	-	-	-	-	-	2,5	2,5	-	120		

PRELIMINARY

# FOLDING SWING-AWAY JIB

# ROADMASTER 9000

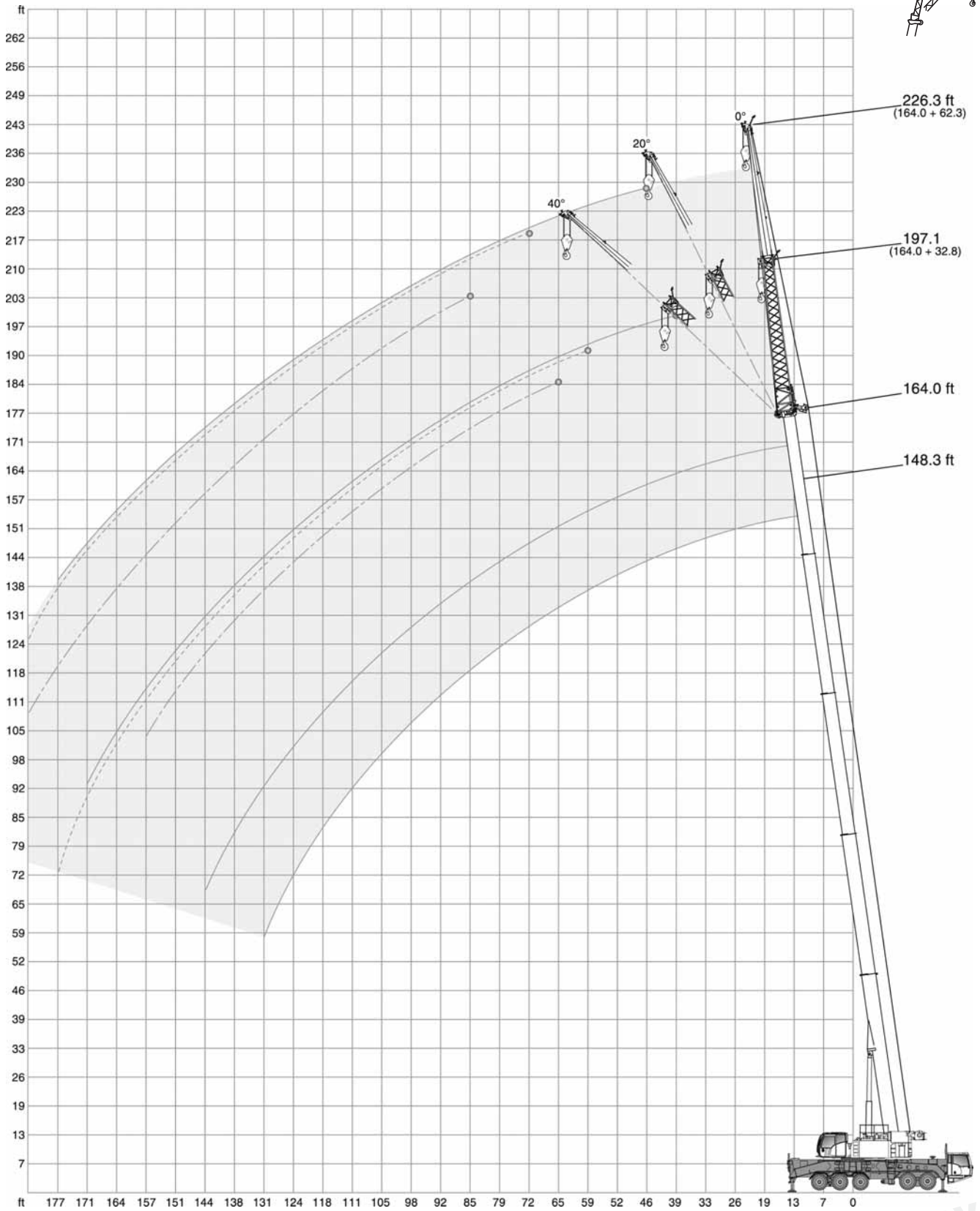
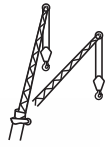

# FOLDING SWING-AWAY JIB

# ROADMASTER 9000

**57,500 lb**  **26 ft x 29 ft 6 in (100%)** **360°** **85 %**

**148.3 ft**

ft	32.8 ft			62.3 ft		
	0°	20°	40°	0°	20°	40°
	1,000 lb					
40	18,9	-	-	10,1	-	-
48	18,7	-	-	10,1	-	-
56	18,3	17,7	-	10,1	-	-
64	17,2	16,8	15,7	10,0	-	-
72	15,9	15,7	15,4	9,7	9,0	-
80	14,6	14,6	14,6	9,4	8,8	7,7
88	13,3	13,4	13,5	9,2	8,5	7,5
96	12,2	12,4	12,5	8,9	8,2	7,4
104	11,2	11,4	11,6	8,6	8,2	7,3
112	10,1	10,3	10,5	8,1	7,9	7,1
120	9,3	9,5	9,5	7,8	7,6	7,0
128	8,6	8,7	8,8	7,4	7,2	6,8
136	7,7	8,1	8,1	7,0	6,9	6,7
144	6,9	6,9	7,1	6,4	6,6	6,6
152	6,3	6,5	-	5,8	6,1	6,3
160	5,5	5,7	-	5,0	5,7	5,9
168	-	-	-	4,7	4,9	5,3
176	-	-	-	4,3	4,4	-
184	-	-	-	3,5	4,0	-

**164.0 ft**

ft	32.8 ft			62.3 ft		
	0°	20°	40°	0°	20°	40°
	1,000 lb					
40	14,8	-	-	-	-	-
48	14,8	-	-	8,2	-	-
56	14,8	-	-	8,2	-	-
64	14,8	14,3	-	8,2	-	-
72	13,9	13,5	12,6	8,2	-	-
80	12,9	12,7	11,8	8,2	8,1	-
88	12,0	11,9	11,3	8,2	7,9	7,2
96	11,0	11,0	10,7	8,2	7,8	7,1
104	10,2	10,4	10,2	8,0	7,5	6,9
112	9,4	9,4	9,7	7,7	7,0	6,6
120	8,6	8,6	8,8	7,2	6,8	6,3
128	7,7	7,9	8,0	6,8	6,4	6,1
136	7,2	7,2	7,4	6,3	6,0	6,0
144	6,4	6,6	6,9	5,8	5,7	5,7
152	5,4	5,8	6,0	5,3	5,5	5,5
160	4,6	5,0	-	4,8	5,1	5,2
168	3,9	4,1	-	4,0	4,7	4,8
176	3,2	3,4	-	3,4	4,1	4,3
184	-	-	-	2,8	3,3	-
192	-	-	-	2,1	2,7	-
200	-	-	-	-	2,0	-

**47,000 lb**  **26 ft x 29 ft 6 in (100%)** **360°** **85 %**

**148.3 ft**

ft	32.8 ft			62.3 ft		
	0°	20°	40°	0°	20°	40°
	1,000 lb					
40	18,9	-	-	10,1	-	-
48	18,7	-	-	10,1	-	-
56	18,3	17,7	-	10,1	-	-
64	17,2	16,8	15,7	10,0	-	-
72	15,9	15,7	15,4	9,7	9,0	-
80	14,6	14,6	14,6	9,4	8,8	7,7
88	13,3	13,4	13,5	9,2	8,5	7,5
96	12,2	12,4	12,5	8,9	8,2	7,4
104	11,2	11,4	11,6	8,6	8,2	7,3
112	9,8	10,3	10,5	8,1	7,9	7,1
120	8,6	8,9	9,3	7,8	7,6	7,0
128	7,7	7,9	7,9	7,2	7,2	6,8
136	6,5	6,9	7,1	6,3	6,9	6,7
144	5,5	5,8	6,0	5,8	6,2	6,6
152	4,7	5,0	-	5,0	5,4	5,8
160	3,9	4,2	-	4,2	4,8	5,1
168	-	-	-	3,5	4,0	4,3
176	-	-	-	2,8	3,2	-
184	-	-	-	2,4	2,6	-

**164.0 ft**

ft	32.8 ft			62.3 ft		
	0°	20°	40°	0°	20°	40°
	1,000 lb					
40	14,8	-	-	-	-	-
48	14,8	-	-	8,2	-	-
56	14,8	-	-	8,2	-	-
64	14,8	14,3	-	8,2	-	-
72	13,9	13,5	12,6	8,2	-	-
80	12,9	12,7	11,8	8,2	8,1	-
88	12,0	11,9	11,3	8,2	7,9	7,2
96	11,0	11,0	10,7	8,2	7,8	7,1
104	10,2	10,4	10,2	8,0	7,5	6,9
112	9,4	9,4	9,7	7,7	7,0	6,6
120	8,1	8,6	8,8	7,2	6,8	6,3
128	6,8	7,4	7,8	6,8	6,4	6,1
136	5,8	6,2	6,6	6,0	6,0	6,0
144	4,7	5,1	5,4	4,9	5,7	5,7
152	3,9	4,3	4,5	4,1	5,0	5,4
160	3,1	3,5	-	3,3	4,2	4,6
168	2,4	2,7	-	2,6	3,3	3,8
176	1,8	2,1	-	2,1	2,5	3,0

PRELIMINARY

# FOLDING SWING-AWAY JIB

# ROADMASTER 9000

 **22,300 lb**  **26 ft x 29 ft 6 in (100%)** **360°** **85 %**

 **148.3 ft**

ft	32.8 ft			62.3 ft		
	0°	20°	40°	0°	20°	40°
	1,000 lb					
40	18,9	-	-	10,1	-	-
48	18,7	-	-	10,1	-	-
56	18,3	17,7	-	10,1	-	-
64	17,2	16,8	15,7	10,0	-	-
72	14,6	15,7	15,4	9,7	9,0	-
80	12,6	13,2	14,1	9,4	8,8	7,7
88	10,3	11,4	11,5	9,0	8,5	7,5
96	8,3	9,2	9,9	8,2	8,2	7,4
104	6,8	7,5	8,1	6,8	7,6	7,3
112	5,4	6,1	6,5	5,7	7,0	7,0
120	4,2	4,8	5,3	4,6	5,7	6,3
128	3,2	3,7	4,2	3,5	4,6	5,5
136	2,4	2,8	3,1	2,6	3,7	4,4
144	1,6	2,0	2,2	2,0	2,7	3,4
152	-	-	-	-	2,1	2,5

 **164.0 ft**

ft	32.8 ft			62.3 ft		
	0°	20°	40°	0°	20°	40°
	1,000 lb					
40	14,8	-	-	-	-	-
48	14,8	-	-	8,2	-	-
56	14,8	-	-	8,2	-	-
64	14,8	14,3	-	8,2	-	-
72	13,9	13,5	12,6	8,2	-	-
80	11,3	12,4	11,8	8,2	8,1	-
88	9,1	10,3	10,9	8,0	7,9	7,2
96	7,3	8,3	9,2	6,9	7,8	7,1
104	5,7	6,8	7,5	5,5	7,2	6,9
112	4,6	5,2	5,9	4,3	5,9	6,6
120	3,3	4,2	4,6	3,3	4,7	5,9
128	2,4	3,1	3,5	2,5	3,7	4,8
136	-	2,2	2,4	-	2,8	3,8
144	-	-	-	-	2,0	2,9

 **11,900 lb**  **26 ft x 29 ft 6 in (100%)** **360°** **85 %**

 **148.3 ft**

ft	32.8 ft			62.3 ft		
	0°	20°	40°	0°	20°	40°
	1,000 lb					
40	18,9	-	-	10,1	-	-
48	18,7	-	-	10,1	-	-
56	17,1	17,7	-	10,1	-	-
64	14,5	15,4	15,7	10,0	-	-
72	11,5	13,0	13,5	9,7	9,0	-
80	9,1	10,5	11,5	8,7	8,8	7,7
88	7,2	8,4	9,3	7,0	8,3	7,5
96	5,7	6,7	7,4	5,5	7,2	7,4
104	4,4	5,0	5,7	4,1	5,7	6,9
112	3,2	3,9	4,3	3,0	4,6	5,9
120	2,2	2,8	3,3	2,2	3,6	4,6
128	-	-	2,2	-	2,8	3,6
136	-	-	-	-	1,9	2,7
144	-	-	-	-	-	1,8

 **164.0 ft**

ft	32.8 ft			62.3 ft		
	0°	20°	40°	0°	20°	40°
	1,000 lb					
40	14,8	-	-	-	-	-
48	14,8	-	-	8,2	-	-
56	14,8	-	-	8,2	-	-
64	12,9	14,3	-	8,2	-	-
72	10,0	11,5	12,6	8,2	-	-
80	7,6	9,1	10,2	7,2	8,1	-
88	5,8	7,1	8,2	5,4	7,5	7,2
96	4,4	5,3	6,3	4,1	6,0	7,1
104	3,2	4,1	4,8	2,8	4,6	6,1
112	-	3,0	3,7	-	3,5	4,8
120	-	-	2,6	-	2,5	3,7
128	-	-	-	-	-	2,8
136	-	-	-	-	-	1,9

# BOOM HEAD EXTENSION

# ROADMASTER 9000

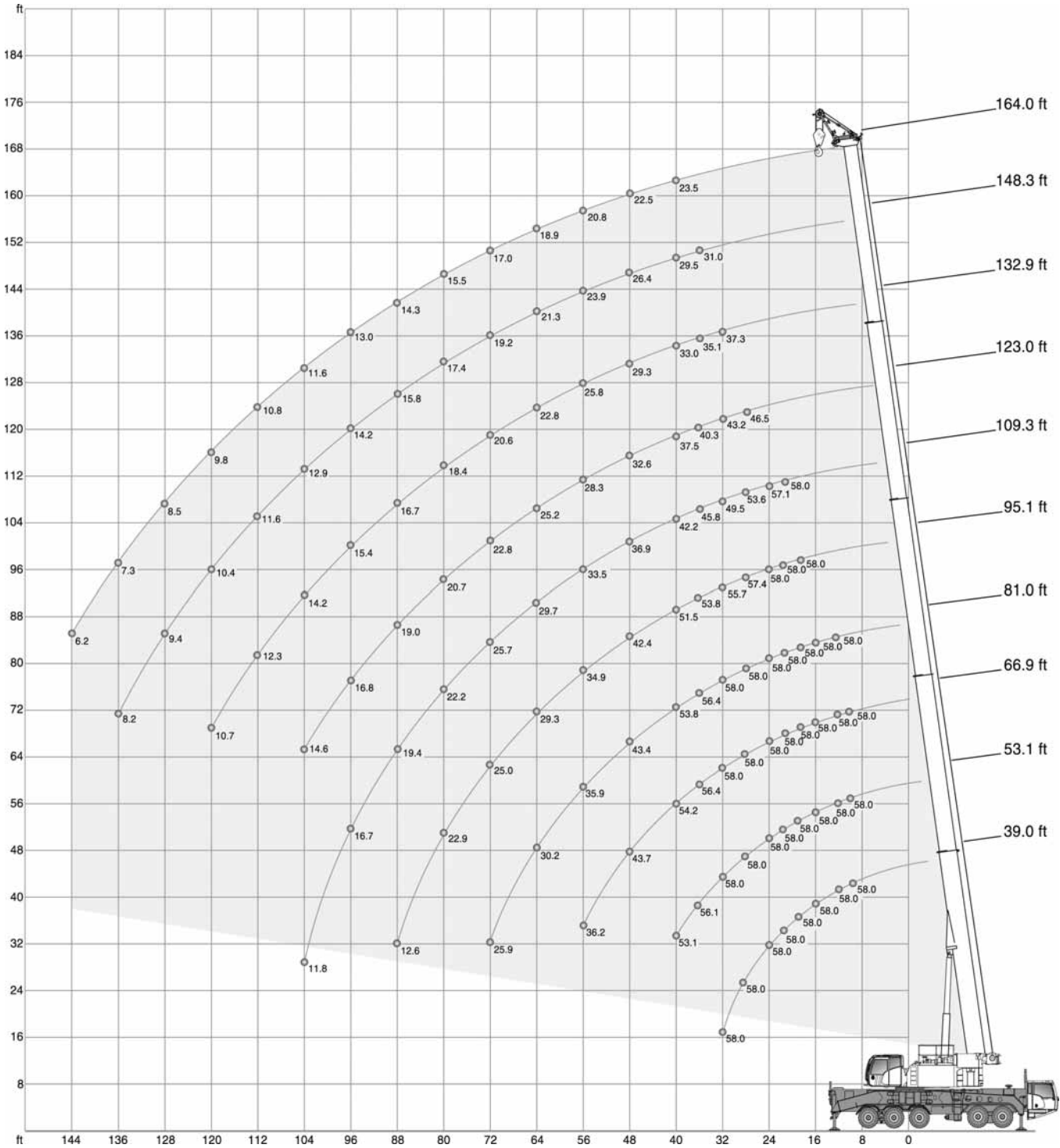
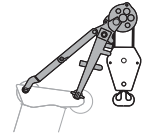

PRELIMINARY

# BOOM HEAD EXTENSION

# ROADMASTER 9000





57,500 lb		26 ft x 29 ft 6 in (100%)										360°		85 %	
		1,000 lb													
ft	ft	39.0 ft	53.1 ft	66.9 ft	81.0 ft	95.1 ft	109.3 ft	123.0 ft	132.9 ft	148.3 ft	164.0 ft	ft	ft		
10	58,0	58,0	58,0	-	-	-	-	-	-	-	-	10	10		
12	58,0	58,0	58,0	58,0	58,0	-	-	-	-	-	-	12	12		
14	58,0	58,0	58,0	58,0	58,0	-	-	-	-	-	-	14	14		
16	58,0	58,0	58,0	58,0	58,0	-	-	-	-	-	-	16	16		
18	58,0	58,0	58,0	58,0	58,0	58,0	-	-	-	-	-	18	18		
20	58,0	58,0	58,0	58,0	58,0	58,0	58,0	-	-	-	-	20	20		
24	58,0	58,0	58,0	58,0	58,0	58,0	57,1	-	-	-	-	24	24		
28	58,0	58,0	58,0	58,0	58,0	57,4	53,6	46,5	-	-	-	28	28		
32	58,0	58,0	58,0	58,0	58,0	55,7	49,5	43,2	37,3	-	-	32	32		
36	-	56,1	56,4	56,4	56,4	53,8	45,8	40,3	35,1	31,0	-	36	36		
40	-	53,1	54,2	53,8	53,8	51,5	42,2	37,5	33,0	29,5	23,5	40	40		
48	-	-	43,7	43,4	42,4	36,9	32,6	29,3	26,4	22,5	48	48			
56	-	-	36,2	35,9	34,9	33,5	28,3	25,8	23,9	20,8	56	56			
64	-	-	-	30,2	29,3	29,7	25,2	22,8	21,3	18,9	64	64			
72	-	-	-	25,9	25,0	25,7	22,8	20,6	19,2	17,0	72	72			
80	-	-	-	-	22,9	22,2	20,7	18,4	17,4	15,5	80	80			
88	-	-	-	-	12,6	19,4	19,0	16,7	15,8	14,3	88	88			
96	-	-	-	-	-	16,7	16,8	15,4	14,2	13,0	96	96			
104	-	-	-	-	-	11,8	14,6	14,2	12,9	11,6	104	104			
112	-	-	-	-	-	-	-	12,3	11,6	10,8	112	112			
120	-	-	-	-	-	-	-	10,7	10,4	9,8	120	120			
128	-	-	-	-	-	-	-	-	9,4	8,5	128	128			
136	-	-	-	-	-	-	-	-	8,2	7,3	136	136			
144	-	-	-	-	-	-	-	-	-	6,2	144	144			





47,000 lb		26 ft x 29 ft 6 in (100%)										360°		85 %	
		1,000 lb													
ft	ft	39.0 ft	53.1 ft	66.9 ft	81.0 ft	95.1 ft	109.3 ft	123.0 ft	132.9 ft	148.3 ft	164.0 ft	ft	ft		
10	58,0	58,0	58,0	-	-	-	-	-	-	-	-	10	10		
12	58,0	58,0	58,0	58,0	58,0	-	-	-	-	-	-	12	12		
14	58,0	58,0	58,0	58,0	58,0	-	-	-	-	-	-	14	14		
16	58,0	58,0	58,0	58,0	58,0	-	-	-	-	-	-	16	16		
18	58,0	58,0	58,0	58,0	58,0	58,0	-	-	-	-	-	18	18		
20	58,0	58,0	58,0	58,0	58,0	58,0	58,0	-	-	-	-	20	20		
24	58,0	58,0	58,0	58,0	58,0	58,0	57,1	-	-	-	-	24	24		
28	58,0	58,0	58,0	58,0	58,0	57,4	53,6	46,5	-	-	-	28	28		
32	58,0	58,0	58,0	58,0	58,0	55,7	49,5	43,2	37,3	-	-	32	32		
36	-	54,8	55,2	55,2	55,2	53,3	45,8	40,3	35,1	31,0	-	36	36		
40	-	50,5	51,8	51,4	50,3	42,2	37,5	33,0	29,5	23,5	40	40			
48	-	-	41,8	41,3	40,3	36,9	32,6	29,3	26,4	22,5	48	48			
56	-	-	34,5	34,1	33,2	33,2	28,3	25,8	23,9	20,8	56	56			
64	-	-	-	28,8	27,7	28,4	25,2	22,8	21,3	18,9	64	64			
72	-	-	-	23,7	24,5	23,5	22,8	20,6	19,2	17,0	72	72			
80	-	-	-	-	20,7	19,6	19,8	18,4	17,4	15,5	80	80			
88	-	-	-	-	12,6	17,2	16,7	16,4	15,6	14,3	88	88			
96	-	-	-	-	-	15,3	14,3	14,0	13,3	13,0	96	96			
104	-	-	-	-	-	11,8	12,7	11,9	11,9	11,1	104	104			
112	-	-	-	-	-	-	-	10,5	10,1	9,4	112	112			
120	-	-	-	-	-	-	-	9,6	8,7	7,8	120	120			
128	-	-	-	-	-	-	-	-	7,4	6,6	128	128			
136	-	-	-	-	-	-	-	-	6,4	5,5	136	136			
144	-	-	-	-	-	-	-	-	-	4,5	144	144			



# BOOM HEAD EXTENSION

# ROADMASTER 9000

 15,200 lb		 26 ft x 29 ft 6 in (100%)										360°		85 %	
															
		39.0 ft	53.1 ft	66.9 ft	81.0 ft	95.1 ft	109.3 ft	123.0 ft	132.9 ft	148.3 ft	164.0 ft				
ft		1,000 lb										ft			
10	58,0	58,0	58,0	-	-	-	-	-	-	-	-	-	10		
12	58,0	58,0	58,0	58,0	-	-	-	-	-	-	-	-	12		
14	58,0	58,0	58,0	58,0	-	-	-	-	-	-	-	-	14		
16	58,0	58,0	58,0	58,0	-	-	-	-	-	-	-	-	16		
18	58,0	58,0	58,0	58,0	58,0	-	-	-	-	-	-	-	18		
20	58,0	58,0	58,0	58,0	58,0	58,0	58,0	-	-	-	-	-	20		
24	58,0	58,0	58,0	58,0	58,0	58,0	57,1	-	-	-	-	-	24		
28	58,0	58,0	58,0	58,0	57,4	53,6	46,5	-	-	-	-	-	28		
32	54,8	55,8	56,7	56,3	53,4	49,5	43,2	37,3	-	-	-	-	32		
36	-	47,8	48,9	48,4	45,8	43,3	39,0	35,1	31,0	-	-	-	36		
40	-	39,6	40,3	39,6	39,0	38,6	35,5	32,7	29,5	23,5	-	-	40		
48	-	-	29,2	30,0	29,7	28,6	28,4	26,9	25,5	22,4	-	-	48		
56	-	-	23,0	23,2	23,1	22,7	22,2	21,1	20,5	19,3	-	-	56		
64	-	-	-	18,3	18,3	18,0	17,4	17,3	16,5	15,1	-	-	64		
72	-	-	-	14,8	14,8	14,4	13,7	14,0	12,9	11,8	-	-	72		
80	-	-	-	-	12,2	11,7	11,1	11,1	10,2	9,1	-	-	80		
88	-	-	-	-	10,2	9,5	8,8	9,0	8,0	7,1	-	-	88		
96	-	-	-	-	-	7,8	7,1	7,1	6,2	5,3	-	-	96		
104	-	-	-	-	-	6,3	5,7	5,7	4,8	3,9	-	-	104		
112	-	-	-	-	-	-	-	4,6	3,5	2,8	-	-	112		
120	-	-	-	-	-	-	-	3,6	2,5	-	-	-	120		

 11,900 lb		 26 ft x 29 ft 6 in (100%)										360°		85 %	
															
		39.0 ft	53.1 ft	66.9 ft	81.0 ft	95.1 ft	109.3 ft	123.0 ft	132.9 ft	148.3 ft	164.0 ft				
ft		1,000 lb										ft			
10	58,0	58,0	58,0	-	-	-	-	-	-	-	-	-	10		
12	58,0	58,0	58,0	58,0	-	-	-	-	-	-	-	-	12		
14	58,0	58,0	58,0	58,0	-	-	-	-	-	-	-	-	14		
16	58,0	58,0	58,0	58,0	-	-	-	-	-	-	-	-	16		
18	58,0	58,0	58,0	58,0	58,0	-	-	-	-	-	-	-	18		
20	58,0	58,0	58,0	58,0	58,0	58,0	58,0	-	-	-	-	-	20		
24	58,0	58,0	58,0	58,0	58,0	57,1	-	-	-	-	-	-	24		
28	58,0	58,0	58,0	58,0	57,4	53,6	46,5	-	-	-	-	-	28		
32	52,3	54,7	55,3	54,7	51,1	47,6	43,2	37,3	-	-	-	-	32		
36	-	46,1	46,8	46,1	43,0	42,0	37,8	34,5	31,0	-	-	-	36		
40	-	37,3	37,9	37,3	38,3	36,0	34,6	31,3	29,3	23,5	-	-	40		
48	-	-	28,3	28,4	27,8	28,0	26,6	25,3	23,6	21,9	-	-	48		
56	-	-	21,6	21,7	21,8	21,2	20,8	20,3	19,4	17,7	-	-	56		
64	-	-	-	17,2	17,1	16,7	16,1	16,2	15,3	13,8	-	-	64		
72	-	-	-	13,7	13,7	13,3	12,6	12,9	11,8	10,4	-	-	72		
80	-	-	-	-	11,3	10,7	10,0	10,2	9,1	8,1	-	-	80		
88	-	-	-	-	9,2	8,6	8,0	8,0	7,1	6,2	-	-	88		
96	-	-	-	-	-	6,9	6,2	6,4	5,3	4,6	-	-	96		
104	-	-	-	-	-	5,5	4,8	5,0	3,9	3,3	-	-	104		
112	-	-	-	-	-	-	-	3,9	2,8	-	-	-	112		
120	-	-	-	-	-	-	-	2,9	-	-	-	-	120		

PRELIMINARY

## Basic equipment

### Carrier

Engine US EPA 2010 Compliant	Detroit Diesel DD13, output 450 HP, torque 1650 ft-lb, certifications in accordance with US EPA 2010.
Engine –OPTIONAL – Not US EPA 2010 Compliant	MTU MBE460, output 450 HP, torque 1475 ft-lb, certifications in accordance with Tier 3.
Fuel tank	70 gallons Diesel; 10 gallons Diesel exhaust fluid.
Transmission	Allison HD4560 fully automatic with 6 forward speeds and 1 reverse.
Axles 8 x 4	48,000 lb front axles, 60,000 lb rear axles with interaxle and diff locks, optional 20,000 lb pusher axle.
Suspension	Full air over walking beam suspensions front and rear.
Steering	Full power steering master and slave steering boxes.
Brakes	Dual circuit pneumatic service brake with drum brakes on all wheels. 4 way antilock brake system and additional exhaust brake. Spring applied parking brake.
Wheels	Aluminium wheels with stainless hub cover, front tires 445/65R22.5, rear tires 315/80R22.5, pusher tires 445/50R22.5.
Cab carrier	Adjustable driver seat with seat heating, armrests and pneumatic suspension; Steering wheel height and tilt adjustable; Power door windows; Tinted glass; Air conditioning and radio ready; 2 integrated rotary beacons; Storage area.
Cruise control	Automatic speed control.

### Crane

Telescopic boom	39.0 - 164 ft; Single cylinder telescoping system, automatic telescoping; Attachments for all equipment and extensions; 5 sheaves integrated in boom head for max. capacity of 142,200 lb.
Counterweight	Configuration EG: 47,000 lb, 6 pieces; Automatic rigging system; Expandable to max. 57,500 lb; 47,000 lb can be carried on board; 10,400 lb fixed.
Outriggers	X-4-Point design with 5th front jack. Manual levelling with electronic pressure indication.
Outrigger pads	4 outrigger pads; 24" diameter (3.14 ft <sup>2</sup> ) each, transport attached to leveling cylinder.
Boom luffing	Single luffing cylinder with automatic lowering brake valve.
Rotary drive	Single slewing gear unit with spring-loaded multi-disc brake.
Main Hoist	Hoist with spring-loaded multi-disc brake.
Engine	MTU; Output 175 HP, torque 464 ft-lb, certifications in accordance with EURO MOT 3b, TIER 4i, CARB; MTU exhaust system made of stainless steel with SCR catalyst.
Fuel tank	53 gallons Diesel.
Drive	Hydraulic system with power control; Hydraulic oil cooler.
Control system	4 simultaneous working movements; Electric pilot controls via 2 two-axis joysticks.
Operator aids	IC-1, with integrated Rated capacity indicator; Color display; Displaying of current operating conditions, load charts, fault indicator; (Pre-)warning when approaching limit devices and conditions; Signal lights indicating LMI-load; Crane data logger; Outrigger load indicator.
Work area definition	Included in RCI function.
Cab	Tilt variable 20°; Seat heating; Sliding window in door and rear; Fold-out front window; Extendable side and foldable front step; Handrails; Tinted safety glass; Pull-down sun visor and light curtains; Air conditioning with 24,000 BTU cooling power and radio preparation.
Cab heating	Engine warm water heating with 41,000 BTU heating power.
Miscellaneous	Safety handrails for cab access.

### Additional Features

Illumination	1 x for hoists and rigging, 1 x adjustable crane cab, 1 x engine area, 2 rotary beacons on rear of crane.
Safety marking	Reflective safety markings on carrier and counterweight.

## Options

### Crane

<b>Boom head extension</b>	Heavy lift attachment, 2-sheaved; Dis-/connectable; For total 7 sheaves at boom head; Max. capacity of 180,000 lb.
<b>Second hoist</b>	2. hoist; Spring-loaded multi-disc brake; Resolver; Self-rigging; Incl. quick couplings and transport storage; Enables 2-hook operation with all extensions.
<b>Auxiliary heating engine independant</b>	Auxiliary, engine independant Diesel heating system with 34,000 BTU heating power; With timer; Switchable between engine block and upper cab.

### Extensions

<b>Folding jib</b>	32.8 ft; Folding swing-away jib, manual offset 20° / 40°; 1-sheaved head; Incl. transport storage.
<b>Double folding jib</b>	32.8 ft / 62.3 ft; Double folding swing-away jib, manual offset 20° / 40°; 1-sheaved head; Incl. transport storage.
<b>Boom head extension</b>	4.9 ft; Boom head extension; 2 sheaves for max capacity 29.4 T; Incl transport storage at boom head.

### Diverse

<b>Dolly preparation</b>	Adjustable 4-point support brackets enable individual positioning of a dolly; Incl. freewheel for slewing gear unit and luffing cylinder, and quick couplings for brake air and electrics.
<b>Hook block 100T</b>	Hook block 7 sheaves, 100 T, 18 mm, 2150 lb.
<b>Hook block 75T</b>	Hook block 5 sheaves, 75 T, 18 mm, 1204 lb.
<b>Hook block 30T</b>	Hook block 3 sheaves, 30 T, 18 mm, 1046 lb.
<b>Overhaul ball 8T</b>	Overhaul ball 360 lb.

## NOTES TO LIFTING CAPACITY

Ratings are in compliance with ISO 4305.  
Lifting capacities do not exceed 85% of tipping load.

Weight of hook blocks and slings is part of the load, and is to be deducted from the capacity ratings.  
Consult operation manual for further details.

**Note:** Data published herein is intended as a guide only and shall not be construed to warrant applicability for lifting purposes.  
Crane operation is subject to the computer charts and operation manual both supplied with the crane.

# ROADMASTER 9000

[www.terexcranes.com](http://www.terexcranes.com)

Effective Date: March 2011.

Product specifications and prices are subject to change without notice or obligation. The photographs and/or drawings in this document are for illustrative purposes only. Refer to the appropriate Operator's Manual for instructions on the proper use of this equipment. Failure to follow the appropriate Operator's Manual when using our equipment or to otherwise act irresponsibly may result in serious injury or death. The only warranty applicable to our equipment is the standard written warranty applicable to the particular product and sale and Terex makes no other warranty, express or implied. Products and services listed may be trademarks, service marks or trade-names of Terex Corporation and/or its subsidiaries in the USA and other countries. All rights are reserved. Terex® is a registered trademark of Terex Corporation in the USA and many other countries.

Copyright 2011 Terex Corporation

Terex Cranes, Global Marketing, Dinglerstraße 24, 66482 Zweibrücken, Germany  
Tel. +49 (0) 6332 830, Email: [info.cranes@terex.com](mailto:info.cranes@terex.com), [www.terexcranes.com](http://www.terexcranes.com)

Brochure Reference: TC-DS-I-E-Roadmaster 9000 - 03/11



**WORKS FOR YOU.™**