

# LORAIN® LRT 200E SERIES

rough terrain cranes  
specifications

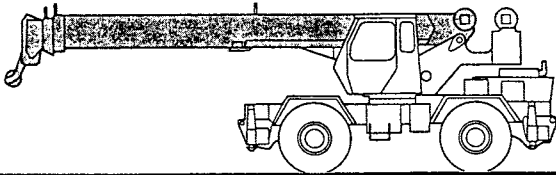

---

## STANDARD BOOM EQUIPMENT

### BOOM

30-72 ft. (9.23-22.19 m), three section full power boom. Telescoping is mechanically synchronized with single lever control. The synchronization system consists of a single telescope cylinder and high strength leaf chains to extend and retract the tip section. Boom is high strength four plate design, welded inside and out, with anti-friction slide pads. Boom side plates are made with stamped impressions to reduce weight and increase strength. A single boom hoist cylinder provides for boom elevation of -4 to 76 degrees. All

cylinders are equipped with integral hold valves. Maximum tip height is 79 ft. (24.23 m).

### BOOM HEAD

Welded to third section of boom. Four or five metallic load sheaves and two idler sheaves mounted on heavy duty, anti-friction bearings. Quick reeving boom head. Provisions made for side-stow jib mounting.

---

## OPTIONAL BOOM EQUIPMENT

### MAIN BOOM

30-94 ft. (9.23-28.78 m), four section full power boom. Telescoping is mechanically synchronized with single lever control. The synchronization system consists of a single telescope cylinder and high strength leaf chains to extend and retract the third section and tip section. Boom is high strength four plate design, welded inside and out, with anti-friction slide pads. Boom side plates are made with stamped impressions to reduce weight and increase strength. A single boom hoist cylinder provides for boom elevation of -4 to 76 degrees. All cylinders are equipped with integral hold valves. Maximum tip height is 99 ft. (30.17 m).

Single sheave mounted on anti-friction bearing. Jib is extendible to 43 ft. (13.11 m) by means of a 17 ft. (5.18 m) manual pull-out tip section, roller supported for ease of extension. Jib is offsettable at 0°, 15°, or 30°. Maximum tip height is 141 ft. (42.99 m).

### AUXILIARY BOOM HEAD

Removable auxiliary boom head has single metallic sheave mounted on anti-friction bearing. Removable pin-type rope guard for quick reeving. Installs on main boom peak only. Removal is not required for jib use.

### JIBS

26 ft. (7.92m) side stow swing-on one-piece lattice type jib. Single metallic sheave mounted on anti-friction bearing. Jib is offsettable at 0°, 15°, or 30°. Maximum tip height is 124 ft. (37.77 m).

### HOOK BLOCK

Two, three, or four metallic sheaves on anti-friction bearings with hook and hook latch. Quick reeving design does not require removal of wedge and socket from rope.

### HOOK & BALL

6.25 ton (5.7 mt) top swivel ball with hook and hook latch.

26-43 ft. (7.92-13.11m) side-stow swing-on lattice type jib.

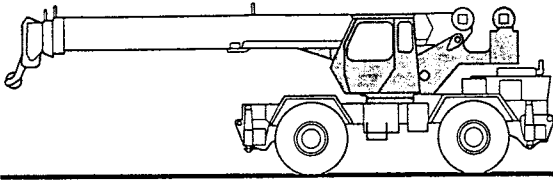

---

## STANDARD UPPERSTRUCTURE EQUIPMENT

### UPPERSTRUCTURE FRAME

All welded one-piece structure fabricated with high tensile strength alloy steel. Counterweight is bolted to frame.

### TURNTABLE CONNECTION

Swing bearing is a single row, ball type, with external teeth. The swing bearing is bolted to the revolving upperstructure and welded to the carrier frame.

### SWING

A hydraulic motor drives a double planetary reduction gear for precise and smooth swing function. Maximum swing speed (no load) is 3.0 rpm.

### SWING BRAKE

Heavy duty multiple disc swing brake is mechanically actuated from operator's cab by foot pedal. Brake may be locked on or used as a momentary brake. A separate 2-position mechanical house lock is also provided.

### RATED LOAD INDICATOR

Built in Rated Load Indicator with visual and audible warning system and automatic function disconnects. On-screen display includes: boom radius, boom angle, allowable load, actual load, and percentage of allowable load registered numerically and by bar graph. Boom length and tip height available at the touch of a button. Anti-two block system with audio/visual warning and automatic function disconnects.

### OPERATOR'S CAB

Environmental cab with all steel construction, optimum visibility, tinted safety glass throughout, and rubber floor matting is mounted on vibration absorbing pads. The cab has a sliding door on the left side, sliding window on the right side, hinged tinted Lexan® skylight and removable front windshield. Acoustical foam padding insulates against sound and weather. The deluxe six-way adjustable operator's seat includes head and arm rests.

### CONTROLS

All control levers and pedals are positioned for efficient operation. Hand operated control levers include swing, telescope, boom hoist, winch(s), shift, and vernier adjustable hand throttle. Foot control pedals include swing brake, boom raise, boom lower, service brakes and accelerator.

### INSTRUMENTATION AND ACCESSORIES

In-cab gauges include air pressure, bubble level, engine oil pressure, fuel, engine temperature, voltmeter, transmission temperature, and transmission oil pressure. Switches include ignition, steering mode, parking brake, and outrigger controls. Indicators include low air, high water temperature/low oil pressure/high transmission temperature audio/visual warning, low coolant audio/visual warning, and Rated Load Indicator. Accessories include fire extinguisher; light package including headlights, tail lights, brake lights, directional signals, four-way hazard flashers, and back-up lights with audio pulsating back-up alarm; windshield washer/wiper; R.H. and L.H. rear view mirrors; dash lights; and seat belt.

### HYDRAULIC CONTROL VALVES

Valves are mounted on the upperstructure and are easily accessible. Valves are mechanically operated and include one four spool valve for boom elevation, telescope, main winch boost, and main winch; and one single spool valve for swing. Quick disconnects are provided for ease of installation of pressure check gauges.

---

### OPTIONAL EQUIPMENT

Auxiliary Winch • Winch Cable Rollers • Drum Rotation Indicators • 360° House Lock • Heater/Defroster • Air Conditioner • Torsion Bar Suspension for Seat • Roof Window Electric Wiper • Tachometer • Work Lights • Revolving Amber Light

---

---

## STANDARD CARRIER EQUIPMENT

### CARRIER CHASSIS

Chassis is Lorain designed and built with four-wheel drive and four-wheel steer (4 x 4 x 4). Has box type construction with reinforcing cross members, a precision machined turntable mounting plate and integrally welded outrigger boxes. Decking has skid-resistant surfaces, including tool storage compartment, and access steps and handles left and right side and front and rear corners.

### AXLES AND SUSPENSION

Rear axle is a planetary drive/steer type with total 10 in. (0.25 m) of oscillation. Automatic oscillation lockouts engage when the superstructure is swung 10° in either direction. Front axle is a planetary drive/steer type, rigid mounted to the frame for increased stability.

### WHEELS & TIRES

Disc type wheels with full tapered bead seat rim. 134 in. (3.40 m) wheelbase.

### TIRES

Standard: 16.00 x 25, 28 P.R.  
Optional: 20.5 x 25, 24 P.R.

### SERVICE BRAKES

Air over hydraulic drum type brakes on all four wheels: 17" x 4" (43.18 x 10.2 cm) drum brakes.

### PARKING BRAKE

Transmission mounted spring-set, air released external caliper disk type emergency/parking brake.

### STEERING

Hydraulic four-wheel power steering for two-wheel, four-wheel, or crab steer is easily controlled by steering wheel.

# STANDARD CARRIER EQUIPMENT (continued)

Turning radius to center of outside tire.

	(standard tires)	(optional tires)
Two-wheel:	34' 8.81" (10.50 m)	34' 10.38" (10.63 m)
Four-wheel:	19' 3.44" (5.88)	19' 5" (5.92 m)

## TRANSMISSION

Range-shift type power-shift transmission with integral torque converter has neutral safety start, 6 speeds forward, and 6 speeds reverse. Automatic pulsating back-up alarm.

## OUTRIGGERS

POWRSPAN® - out and down fully independent hydraulic outriggers extending 19 ft. (5.79 m) centerline to centerline. Easily removable steel floats, each with an area of 254 in<sup>2</sup> (1639 cm<sup>2</sup>), stow on the carrier frame. Complete controls and sight leveling bubble are located in the operator's cab.

## HYDRAULIC SYSTEM

### HYDRAULIC PUMPS

Three gear type pumps, one single and two in tandem, driven off the transmission. Combined system capability is 113 gpm (427.7 lpm). Includes manual pump disconnect.

### Main and Auxiliary Winch Pump

53 gpm (200.7 lpm) @ 3,500 psi (246.1 kg/cm<sup>2</sup>)

### Boom Hoist, Telescope Pump

39 gpm (147.6 lpm) @ 3,500 psi (246.1 kg/cm<sup>2</sup>)

### Power Steering, Outrigger and Swing Pump

21 gpm (79.5 lpm) @ 2,500 psi (175 kg/cm<sup>2</sup>). Always live even when pump disconnect is actuated.

## FILTRATION

Full flow oil filtration system with bypass protection includes a removable 60 mesh (250 micron) suction screen-type filter and 5 micron replaceable return line filter.

## HYDRAULIC RESERVOIR

All steel, welded construction with internal baffles and diffuser. Provides easy access to filters and is equipped with an external sight level gauge. The hydraulic tank is pressurized to aid in keeping out contaminants and in reducing potential pump cavitation. Capacity is 94 gal (355 liters). Swing-away hydraulic oil cooler is standard.

## OPTIONAL EQUIPMENT

Cold Weather Starting Aid • Immersion Heater • Rear Axle Centering Light • Pintle Hook • Clearance Lights

## MAIN WINCH SPECIFICATIONS

Lorain built hydraulic winch with geroller, motor and planetary reduction provides 2-speed operation with equal speeds for power up and down. Winch is equipped with an integral automatic brake and a grooved drum with tapered flanges for improved rope spooling.

PERFORMANCE	LO-RANGE	HI-RANGE
Max. line speed (no load)		
First layer	190 fpm (57.9 m/min)	328 fpm (100 m/min)
Fifth layer	275 fpm (83.8 m/min)	474 fpm (144.5 m/min)
Max. line pull-first layer	11,825 lbs (5,363 kg)	
Max. line pull-fifth layer	8,185 lbs (3,712 kg)	
Permissible line pull	9,000 lbs (4082 kg)	

DRUM DIMENSIONS	DRUM CAPACITY
10.62 in (270 mm) drum diameter	Max. Storage: 540 ft (164.6 m)
16.00 in (406 mm) length	6th layer not a working layer
17.88 in (454 mm) flange dia.	Max. Useable: 430 ft (131.1 m)*
Cable: 5/8 in. x 450 ft (16 mm x 137.2 m)	
Cable type: 5/8 in. (16 mm) 6x19 IWRC IPS right regular lay, preformed.	*Based on minimum flange height above top layer to comply with ANSI B30.5.
Min. breaking strength 17.9 tons (16.2 mt).	

**OPTIONAL HOIST LINE** - 5/8 in. (16 mm) rotation resistant compacted strand 18 x 19 or 19 x 19. Min. breaking strength 22.6 tons (20.6 mt).

## OPTIONAL AUXILIARY WINCH

Lorain hydraulic winch with geroller, motor, power up and down, equal speed, planetary reduction with integral automatic brake.

PERFORMANCE	
Max. line speed (no load)	
Fifth layer	275 fpm (83.8 m/min)
Max. line pull	
First layer	11,825 lbs (5,363 kg)

DRUM DIMENSIONS
10.62 in (270 mm) drum diameter
16.00 in (406 mm) length
17.88 in (454 mm) flange diameter
Cable: 5/8 in. x 450 ft. (16 mm x 137.2 m)
Cable type: 5/8 in. (16 mm) 6 x 19 IWRC IPS right regular lay preformed. Min. breaking strength 17.9 tons (16.2 mt).

DRUM CAPACITY
Max. storage: 540 ft (164.6 m)
Max. Useable: 430 ft (131.1 m)*

**OPTIONAL HOIST LINE** - 5/8 in. (16 mm) rotation resistant compacted strand 18 x 19 or 19 x 19. Min. breaking strength 22.6 tons (20.6 mt).

## PERFORMANCE (Standard Engine)

Transmission Range	Gear	Forward Drive	Maximum Speed	Maximum Tractive Effort	Gradeability @ Stall
Low	1	4-wheel	2.3 mph 3.7 km/h	37,856 lbs 17,171 kg	112.34%
	2	4-wheel	4.4 mph 7.1 km/h	19,254 lbs 8,734 kg	39.84%
	3	4-wheel	12.4 mph 20.0 km/h	6,431 lbs 2,917 kg	11.10%
High	1	2-wheel	5.0 mph 8.0 km/h	16,893 lbs 7,663 kg	34.04%
	2	2-wheel	9.5 mph 15.3 km/h	8,589 lbs 3,896 kg	15.59%
	3	2-wheel	24.5 mph 39.4 km/h	2,849 lbs 1,292 kg	3.77%

All performance data is based on a gross vehicle weight of 52,000 lbs. (23,583 kg). 16:00 x 25 tires, 4 x 4 drive. Performance may vary due to engine performance. Gradeability data is theoretical and is limited by tire slip, stability, or engine oil pan design.

## ENGINE SPECIFICATIONS

Make and Model	Standard Cummins 6BT5.9	Optional Caterpillar 3116 DIT
Type	6 cylinder	6 cylinder
Bore and Stroke	4.02 x 4.72 in. (102 x 120 mm)	4.12 x 5.0 in. (105 x 127 mm)
Displacement	359 cu. in. (5.9 l)	402 cu. in. (6.6 l)
Max. Gross Horsepower	130 hp (97 kw) @ 2500 rpm	140 hp (105 kw) @ 2400 rpm
Max. Gross Torque	368 lb-ft (499 N-m) @ 1200 rpm	426 lb-ft (578 N-m) @ 1400 rpm
Aspiration	turbocharged	turbocharged
Air Filter	dry type	dry type
Electrical System	12 volt	12 volt
Alternator	102 amp	115 amp
Battery	(2) 12V-1250 C.C.A.	(2) 12V-1600 C.C.A.
Fuel Capacity	50 gal (189 l)	50 gal (189 l)

# GENERAL DIMENSIONS

**NOTES:**

- Dimensions given assume the boom is fully retracted in travel position and 16:00 x 25 tires.
- Minimum ground clearance under transmission - 20.62" (0.52 m)  
 axle bowls - 19.12" (0.49 m)  
 tie rods - 20.38" (0.52 m)
- Track width: 6' 7.50" (2.02 m) 16:00 x 25 tires  
 6' 10.5" (2.10 m) 20.5 x 25 tires

- Width of carrier:  
 8'0" (2.44 m) 16:00 x 25 tires  
 8'8" (2.64 m) 20.5 x 25 tires

Tire to frame angle	16:00 tires
Approach angle:	25.1°
Departure angle:	23.1°

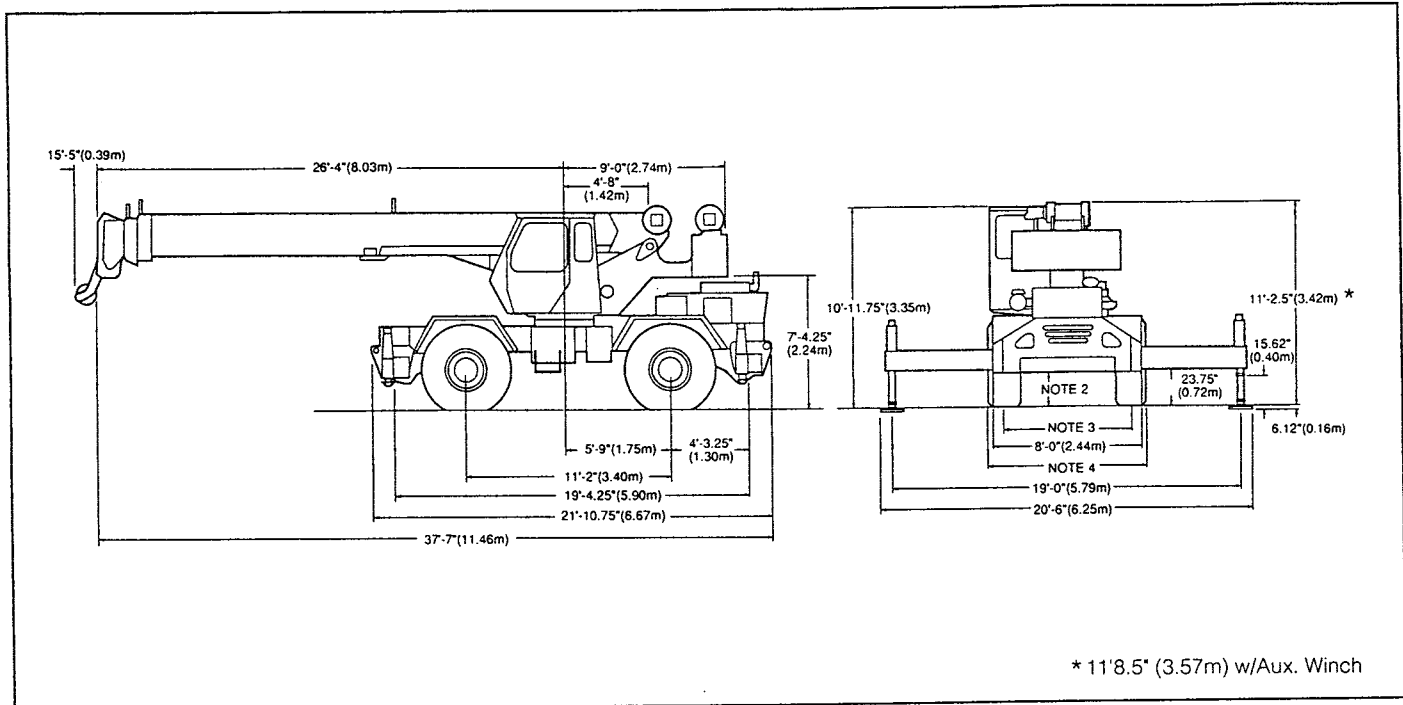

WEIGHTS & AXLE LOADS	GROSS WEIGHT LBS.	UPPER FACING FRONT		GROSS WEIGHT KG.	UPPER FACING FRONT	
		FRONT	REAR		FRONT	REAR
Basic Crane with 8,000 lb. (3628 kg) Counterweight	50,220	25,005	25,210	22,780	11,342	11,435
<b>Add Options:</b>						
26' (7.92 m) Swing-on Jib (Stowed)	+ 1,100	+ 2,000	- 900	+ 499	+ 907	- 408
26'-43' (7.92-13.11 m) Swing-on Jib (Stowed)	+ 1,500	+ 2,600	- 1,100	+ 680	+ 1,179	- 499
Auxiliary Boom Head	+ 100	+ 300	- 200	+ 45	+ 136	- 91
Auxiliary Winch Controls and Plumbing Only	+ 75	+ 0	+ 75	+ 34	+ 0	+ 34
Auxiliary Winch with Wire Rope, Controls, Etc.	+ 115	- 25	+ 140	+ 52	- 11	+ 63
30 ton (27.2 mt) 4 Sheave Hook Block	+ 660	+ 1,080	- 420	+ 299	+ 492	- 193
30 ton (27.2 mt) 3 Sheave Hook Block	+ 640	+ 1,050	- 410	+ 290	+ 477	- 187
22 ton (20 mt) 2 Sheave Hook Block	+ 580	+ 950	- 370	+ 263	+ 432	- 169
6.25 ton (5.7 mt) Hook and Ball (In tool box)	+ 240	+ 290	- 50	+ 109	+ 130	- 21
Pintle Hook : Front	+ 45	+ 60	- 15	+ 20	+ 27	- 7
Rear	+ 45	- 25	+ 70	+ 20	- 11	+ 31
<b>Substitute:</b>						
94' (28.78 m) Full Power 4-section Boom	+ 3,190	+ 4,335	- 1,145	+ 1,445	+ 1,965	- 520
20.5 x 25 Tires	+ 360	+ 180	+ 180	+ 164	+ 82	+ 82

NOTE: Weights are for Lorain supplied equipment and subject to 2% variation due to manufacturing tolerances.

WE RESERVE THE RIGHT TO AMEND THESE SPECIFICATIONS AT ANY TIME WITHOUT NOTICE. THE ONLY WARRANTY APPLICABLE IS OUR STANDARD WRITTEN WARRANTY APPLICABLE TO THE PARTICULAR PRODUCT AND SALE. WE MAKE NO OTHER WARRANTY, EXPRESSED OR IMPLIED.



Koehring Cranes & Excavators  
 Waverly, Iowa 50677

# LORAIN<sup>®</sup> LRT 230E

rough terrain crane  
30 ton capacity

range diagrams & lifting capacities

## Range Diagram (30' - 72' boom)

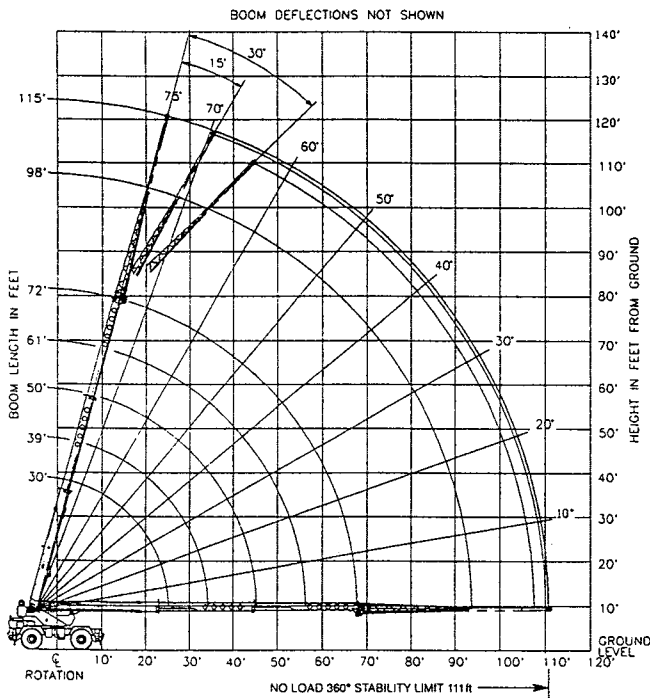

## Range Diagram (30' - 94' boom)

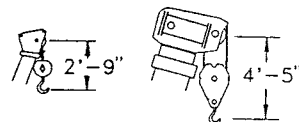
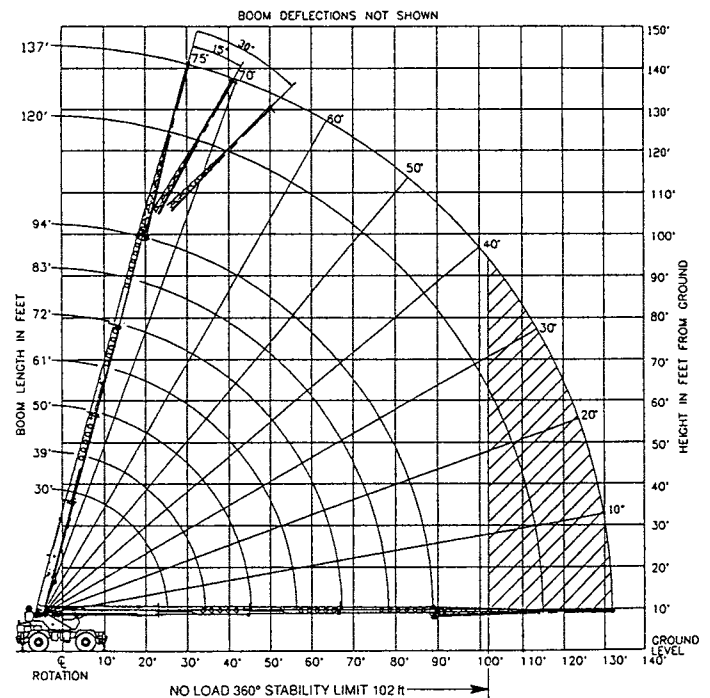

DIMENSIONS ARE FOR LARGEST KOEHRING  
FURNISHED HOOK BLOCK AND HEADACHE  
BALL. WITH ANTI-BLOCK ACTIVATED.

### CRANE WORKING CONDITIONS

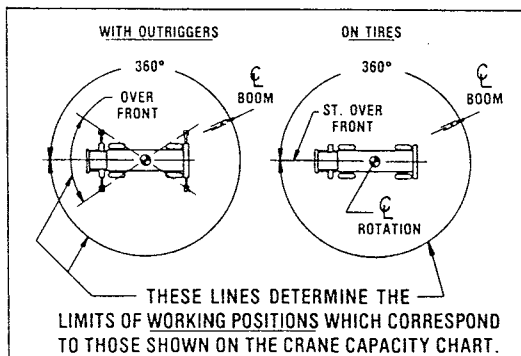

### REDUCTION IN MAIN BOOM CAPACITY

All Jibs in Stowed Position	0 Lbs.
Aux. Boom Head Sheave	100 Lbs.

### HOOK BLOCK WEIGHTS

Hook & Ball	239 Lbs.
Hook Block (2 Sheave)	580 Lbs.
Hook Block (3 Sheave)	640 Lbs.
Hook Block (4 Sheave)	660 Lbs.

# Lifting Capacities — Pounds (30' - 72' boom)

## MODEL LRT 230E

COUNTERWEIGHT W/AUX. WINCH 6900 lb. STABILITY PCT. ON OUTRIGGERS 85%  
 W/O AUX. WINCH 8000 lb. ON TIRES 75%  
 BOOM LENGTH 30-72 ft. PCSA CLASS 10-110  
 OUTRIGGER SPREAD 19 ft.

**CAUTION:** Do not use this specification sheet as a load rating chart. The format of data is not consistent with the machine chart and may be subject to change.

### ON OUTRIGGERS

LOAD RADIUS (FT)	BOOM LENGTH 30 FT			BOOM LENGTH 39 FT			BOOM LENGTH 50 FT			BOOM LENGTH 61 FT			BOOM LENGTH 72 FT			LOAD RADIUS (FT)
	LOADED BOOM ANGLE (DEG)	OVER FRONT (LB)	360° (LB)	LOADED BOOM ANGLE (DEG)	OVER FRONT (LB)	360° (LB)	LOADED BOOM ANGLE (DEG)	OVER FRONT (LB)	360° (LB)	LOADED BOOM ANGLE (DEG)	OVER FRONT (LB)	360° (LB)	LOADED BOOM ANGLE (DEG)	OVER FRONT (LB)	360° (LB)	
10	63.0	60,000*	60,000*	69.4	45,600*	45,600*										10
12	59.5	45,800*	45,800*	66.5	42,800*	42,800*	72.4	40,400*	40,400*							12
15	52.4	38,700*	38,700*	62.0	37,400*	37,400*	68.9	35,100*	35,100*	73.5	33,500*	33,500*				15
20	35.1	27,600*	27,600*	53.6	28,200*	28,200*	63.0	28,600*	28,600*	68.7	27,500*	27,500*	72.7	23,600*	23,600*	20
25	16.0	20,800*	20,800*	43.6	21,500*	21,500*	56.4	21,900*	21,900*	63.8	22,200*	22,200*	68.7	19,900*	19,900*	25
30	**			28.7	16,900*	16,900*	47.9	17,400*	17,400*	58.4	17,600*	17,600*	64.5	17,100*	17,100*	30
35				**			36.0	14,200*	14,100	51.9	14,400*	14,400	59.9	14,600*	14,600	35
40							22.1	11,700*	11,000	43.7	12,000*	11,400	54.3	12,200*	11,600	40
45							7.4	9,800	8,800	34.4	10,000	9,200	47.9	10,300	9,400	45
50							**			24.6	8,300	7,500	40.4	8,600	7,700	50
55										14.6	6,900	6,200	32.6	7,200	6,400	55
60										**			24.7	6,100	5,300	60
65													16.7	5,100	4,500	65
70										**			**			70

### \*\*MAXIMUM CAPACITY AT 0 DEGREE BOOM ANGLE

BOOM LENGTH 30 FT			BOOM LENGTH 39 FT			BOOM LENGTH 50 FT			BOOM LENGTH 61 FT			BOOM LENGTH 72 FT		
LOAD RADIUS (FT)	OVER FRONT (LB)	360° (LB)	LOAD RADIUS (FT)	OVER FRONT (LB)	360° (LB)	LOAD RADIUS (FT)	OVER FRONT (LB)	360° (LB)	LOAD RADIUS (FT)	OVER FRONT (LB)	360° (LB)	LOAD RADIUS (FT)	OVER FRONT (LB)	360° (LB)
26.62	20,000*	20,000*	34.33	14,000*	14,000	45.33	9,600	8,700	56.33	6,600	5,900	67.33	5,000	4,400

### ON TIRES

RADIUS (FT)	MAX BOOM LENGTH (FT)	16:00 X 25-28PR				20:50 X 25-24PR				RADIUS (FT)
		PICK & CARRY		PICK & CARRY		PICK & CARRY		PICK & CARRY		
		STATIONARY 360°	STRAIGHT OVER FRONT	STATIONARY 360°	STRAIGHT OVER FRONT	STATIONARY 360°	STRAIGHT OVER FRONT	STATIONARY 360°	STRAIGHT OVER FRONT	
10	30	21,000	46,700*	37,000*	27,400*	22,100	45,000*	35,600*	24,600*	10
12	30	18,200	34,600*	31,800*	23,300*	17,600	38,600*	30,900*	21,200*	12
15	39	11,900	25,000	25,000	19,700*	12,500	26,300	25,700*	17,300*	15
20	39	7,600	15,800	15,800	14,500*	7,800	15,700	15,700	12,700*	20
25	50	5,000	10,900	10,900	10,900	5,200	10,700	10,700	9,900*	25
30	50	3,400	7,800	7,800	7,800	3,600	7,900	7,900	7,900	30
35	50	2,200	6,000	6,000	6,000	2,200	6,000	6,000	6,000	35
40	61	1,000	4,600	4,600	4,600	1,000	4,500	4,500	4,500	40
45	61		3,700	3,700	3,700		3,600	3,600	3,600	45
50	61		3,100	3,100	3,100		3,100	3,100	3,100	50
55	61		2,900	2,900	2,900		2,900	2,900	2,900	55

### SIDE STOW JIB ON OUTRIGGERS

LOADED BOOM ANGLE (DEG)	LOAD RADIUS (REF) (FT)	26 FT OFFSETTABLE JIB						43 FT OFFSETTABLE JIB						LOAD RADIUS (REF) (FT)	LOAD RADIUS (REF) (FT)
		0° OFFSET		15° OFFSET		30° OFFSET		0° OFFSET		15° OFFSET		30° OFFSET			
		LOAD RADIUS (REF) (FT)	360° (LB)	LOAD RADIUS (REF) (FT)	360° (LB)	LOAD RADIUS (REF) (FT)	360° (LB)	LOAD RADIUS (REF) (FT)	360° (LB)	LOAD RADIUS (REF) (FT)	360° (LB)	LOAD RADIUS (REF) (FT)	360° (LB)		
75	27'-7"	13,000*	30'-1"	7,700*	40'-5"	5,500*	27'-7"	5,000*	32'-7"	3,200*	47'-2"	2,400*	75		
73	30'-8"	11,800*	33'-11"	7,200*	42'-10"	5,300*	33'-9"	4,800*	39'-7"	3,100*	51'-5"	2,300*	73		
71	33'-10"	10,900*	37'-6"	6,800*	45'-2"	5,100*	39'-11"	4,600*	45'-5"	2,900*	55'-3"	2,300*	71		
68	38'-4"	9,900*	42'-6"	6,400*	48'-9"	4,900*	46'-2"	4,300*	52'-9"	2,700*	60'-9"	2,200*	68		
65	42'-6"	9,000*	47'-1"	6,000*	52'-2"	4,700*	52'-6"	3,900*	58'-11"	2,500*	65'-6"	2,200*	65		
62	46'-8"	8,300*	51'-5"	5,600*	55'-7"	4,500*	58'-11"	3,500*	64'-6"	2,400*	69'-11"	2,200*	62		
59	50'-8"	7,600*	55'-6"	5,300*	58'-11"	4,400*	63'-3"	3,200*	69'-5"	2,300*	74'-0"	2,200*	59		
55	55'-10"	6,700*	60'-8"	4,900*	63'-3"	4,200*	69'-6"	2,800*	75'-3"	2,200*	79'-1"	2,100*	55		
51	60'-11"	5,700	65'-5"	4,600*	67'-9"	4,100*	75'-1"	2,600*	80'-6"	2,200*	83'-9"	2,100*	51		
47	65'-7"	4,900	70'-1"	4,500	72'-3"	4,100	80'-3"	2,400*	85'-3"	2,100*	87'-11"	2,100*	47		
43	70'-4"	4,300	74'-5"	4,000	76'-2"	3,800	85'-0"	2,300*	89'-7"	2,100*	91'-10"	2,100*	43		
38	75'-8"	3,700	79'-1"	3,500	80'-5"	3,300	90'-5"	2,200*	94'-6"	2,100*	96'-2"	2,100*	38		
32	80'-11"	3,200	83'-9"	2,900	84'-6"	2,900	96'-3"	2,100	99'-7"	2,100	101'-0"	2,100	32		
25	85'-11"	2,700	88'-1"	2,500			102'-11"	2,000	105'-3"	2,000			25		
17	90'-5"	2,300	91'-11"	2,200			107'-10"	1,800	108'-10"	1,800			17		

#### NOTES FOR ON TIRE CAPACITIES

- A. For Pick and Carry operations, boom must be centered over the front of the crane with swing brake and lock engaged. Use minimum boom point height and keep load close to ground surface.
- B. The load should be restrained from swinging. NO ON TIRE OPERATION WITH JIB ERECTED.
- C. Without outriggers, never maneuver the boom beyond listed load radii for applicable tires to ensure stability.
- D. Creep speed is crane movement of less than 200 Ft. (61m) in a 30 minute period and not exceeding 1.0 mph (1.6 km/h).
- E. Refer to General Notes for additional information.

#### NOTES FOR JIB CAPACITIES

- F. For all boom lengths less than the maximum with a jib erected, the rated loads are determined by boom angle only in the appropriate column.
- G. For boom angle not shown, use the capacity of the next lower boom angle.
- H. Listed radii are for fully extended main boom only.

### MAX. PERMISSIBLE HOIST LINE LOAD

MAXIMUM PERMISSIBLE HOIST LINE LOAD							
LINE PARTS	1	2	3	4	5	6	7
MAX. LOAD	9,080	18,160	27,240	36,320	45,400	54,480	65,560
BOOM HEAD	2	2-D	2-3	1-2-D	1-2-3	1-2-3-D	1-2-3-4
HOOK BLOCK	D	2	2-D	1-2	1-2-D	1-2-3	1-2-3-D
WIRE ROPE: 5/8" ROTATION RESISTANT COMPACTED STRAND, 18X19 OR 19X19 MINIMUM BREAKING STRENGTH - 22.7 TONS							
5/8" 6X19 OR 6X37 IWRC IPS PERFORMED RIGHT REGULAR LAY MINIMUM BREAKING STRENGTH - 17.9 TONS							

### RECOMMENDED TIRE PRESSURES

TIRE SIZE	STATIONARY	CREEP	2 1/2 MPH	TRAVEL
16.00 X 25-28 PR	115 PSI	115 PSI	95 PSI	80 PSI
20.50 X 25-24 PR	95 PSI	95 PSI	70 PSI	70 PSI

# Lifting Capacities — Pounds (30' - 94' boom)

## MODEL LRT 230E

COUNTERWEIGHT  
W/AUX. WINCH 6900 lb.  
W/O AUX. WINCH 8000 lb.  
BOOM LENGTH 30-94 ft.  
OUTRIGGER SPREAD 19 ft.

STABILITY PCT.  
ON OUTRIGGERS 85%  
ON TIRES 75%  
PCSA CLASS 10-106

**CAUTION:** Do not use this specification sheet as a load rating chart. The format of data is not consistent with the machine chart and may be subject to change.

### ON OUTRIGGERS

LOAD RADIUS (FT)	BOOM LENGTH 30 FT			BOOM LENGTH 39 FT			BOOM LENGTH 50 FT			BOOM LENGTH 61 FT			BOOM LENGTH 72 FT			BOOM LENGTH 83 FT			BOOM LENGTH 94 FT			LOAD RADIUS (FT)
	LOADED BOOM ANGLE (DEG)	OVER FRONT (LB)	360° (LB)	LOADED BOOM ANGLE (DEG)	OVER FRONT (LB)	360° (LB)	LOADED BOOM ANGLE (DEG)	OVER FRONT (LB)	360° (LB)	LOADED BOOM ANGLE (DEG)	OVER FRONT (LB)	360° (LB)	LOADED BOOM ANGLE (DEG)	OVER FRONT (LB)	360° (LB)	LOADED BOOM ANGLE (DEG)	OVER FRONT (LB)	360° (LB)	LOADED BOOM ANGLE (DEG)	OVER FRONT (LB)	360° (LB)	
10	63.0	60,000*	60,000*	69.4	46,500*	46,500*																10
12	59.5	44,500*	44,500*	66.5	41,700*	41,700*	72.4	39,300*	39,300*													12
15	52.4	37,800*	37,800*	62.0	36,200*	36,200*	68.9	34,000*	34,000*	73.5	32,500*	32,500*										15
20	35.1	26,400*	26,400*	53.6	27,200*	27,200*	63.0	27,700*	27,700*	68.7	26,400*	26,400*	72.7	25,400*	25,400*							20
25	16.0	19,500*	19,500*	43.6	20,400*	20,400*	56.4	20,900*	20,900*	63.8	21,200*	21,200*	68.7	21,300*	21,300*	72.2	18,900*	18,900*	74.7	15,200*	15,200*	25
30	**			28.7	15,800*	15,800*	47.9	16,300*	16,300*	58.4	16,600*	16,600*	64.5	16,900*	16,900*	68.5	15,800*	15,800*	71.8	13,000*	13,000*	30
35				**			36.0	13,000*	13,000*	51.9	13,400*	13,400*	59.9	13,600*	13,600*	64.7	13,700*	13,700*	68.8	11,300*	11,300*	35
40							22.1	10,600*	10,600*	43.7	10,900*	10,900*	54.3	11,100*	11,100*	60.9	11,300*	11,300*	65.7	9,900*	9,900*	40
45							7.4	8,600*	8,300*	34.4	9,000*	8,800*	47.9	9,200*	8,900*	56.6	9,400*	9,000*	62.1	8,700*	8,700*	45
50							**			24.6	7,200*	6,900*	40.4	7,500*	7,100*	51.7	7,700*	7,300*	57.7	7,800*	7,400*	50
55										14.6	5,800*	5,500*	32.6	6,100*	5,800*	46.1	6,200*	5,900*	53.2	6,400*	6,100*	55
60										**			24.7	5,600*	4,700*	39.7	5,100*	4,800*	47.9	5,200*	5,000*	60
65													16.7	4,800*	3,700*	33.0	4,200*	3,900*	42.4	4,300*	4,100*	65
70													**			26.2	3,400*	3,200*	36.7	3,600*	3,300*	70
75																19.4	2,700*	2,500*	31.0	2,900*	2,700*	75
80																**			25.1	2,300*	2,100*	80
85																			19.3	1,800*	1,600*	85
90																			**			90

### \*\*MAXIMUM CAPACITY AT 0 DEGREE BOOM ANGLE

BOOM LENGTH 30 FT			BOOM LENGTH 39 FT			BOOM LENGTH 50 FT			BOOM LENGTH 61 FT			BOOM LENGTH 72 FT			BOOM LENGTH 83 FT			BOOM LENGTH 94 FT		
LOAD RADIUS (FT)	OVER FRONT (LB)	360° (LB)	LOAD RADIUS (FT)	OVER FRONT (LB)	360° (LB)	LOAD RADIUS (FT)	OVER FRONT (LB)	360° (LB)	LOAD RADIUS (FT)	OVER FRONT (LB)	360° (LB)	LOAD RADIUS (FT)	OVER FRONT (LB)	360° (LB)	LOAD RADIUS (FT)	OVER FRONT (LB)	360° (LB)	LOAD RADIUS (FT)	OVER FRONT (LB)	360° (LB)
25.62	18,700*	18,700*	34.33	12,700*	12,700*	45.33	8,400*	8,100*	56.33	5,500*	5,200*	67.33	3,700*	3,400*	78.33	2,400*	2,200*	89.33	1,700*	1,500*

### ON TIRES

RADIUS (FT)	MAX BOOM LENGTH (FT)	16.00 X 25-28PR				20.50 X 25-24 PR				RADIUS (FT)
		STATIONARY		CREEP 2.5 MPH		STATIONARY		CREEP 2.5 MPH		
		360°	STRAIGHT OVER FRONT	360°	STRAIGHT OVER FRONT	360°	STRAIGHT OVER FRONT	360°	STRAIGHT OVER FRONT	
10	30	24,300	44,000*	34,700*	25,500*	22,500	42,400*	33,300*	22,800*	10
12	30	17,600	38,400*	30,200*	22,000*	17,400	35,000*	29,000*	19,600*	12
15	39	11,800	25,300	25,000*	18,000*	12,500	27,000*	24,000*	16,000*	15
20	39	6,800	14,900	14,900	13,400*	7,600	15,900	15,900	11,800*	20
25	50	4,800	10,500	10,500	10,200*	4,600	10,700	10,700	8,900*	25
30	50	2,900	7,400	7,400	7,400	2,900	7,400	7,400	7,400	30
35	50	2,200	5,900	5,900	5,900	1,700	5,400	5,400	5,400	35
40	61	1,300	4,400	4,400	4,400	1,000	4,100	4,100	4,100	40
45	61		3,300	3,300	3,300		3,300	3,300	3,300	45
50	61		2,700	2,700	2,700		2,500	2,500	2,500	50
55	61		2,000	2,000	2,000		1,800	1,800	1,800	55

#### NOTES FOR ON TIRE CAPACITIES

- A. For Pick and Carry operations, boom must be centered over the front of the crane with swing brake and lock engaged. Use minimum boom point height and keep load close to ground surface.
- B. The load should be restrained from swinging. NO ON TIRE OPERATION WITH JIB ERECTED.
- C. Without outriggers, never maneuver the boom beyond listed load radii for applicable tires to ensure stability.
- D. Creep speed is crane movement of less than 200 Ft. (61m) in a 30 minute period and not exceeding 1.0 mph (1.6 km/h).
- E. Refer to General Notes for additional information.

### SIDE STOW JIB ON OUTRIGGERS

LOADED BOOM ANGLE (DEG)	26 FT OFFSETTABLE JIB						43 FT OFFSETTABLE JIB						LOADED BOOM ANGLE (DEG)
	0° OFFSET		15° OFFSET		30° OFFSET		0° OFFSET		15° OFFSET		30° OFFSET		
	LOAD RADIUS (REF) (FT)	360° (LB)	LOAD RADIUS (REF) (FT)	360° (LB)	LOAD RADIUS (REF) (FT)	360° (LB)	LOAD RADIUS (REF) (FT)	360° (LB)	LOAD RADIUS (REF) (FT)	360° (LB)	LOAD RADIUS (REF) (FT)	360° (LB)	
75	32'-0"	9,000*	38'-0"	7,900*	43'-0"	5,500*	53'-6"	5,000*	66'-11"	3,200*	72'-3"	2,400*	75
73	37'-7"	8,500*	41'-0"	6,700*	46'-0"	5,200*	56'-7"	4,800*	68'-8"	3,100*	74'-7"	2,300*	73
71	41'-2"	8,000*	44'-3"	6,200*	49'-8"	4,900*	59'-7"	4,600*	71'-3"	2,900*	76'-11"	2,300*	71
68	48'-0"	7,200*	52'-3"	5,600*	54'-2"	4,500*	64'-11"	4,300*	75'-11"	2,700*	80'-6"	2,200*	68
65	53'-2"	6,200*	58'-11"	5,000*	59'-2"	4,000*	68'-7"	3,900*	79'-0"	2,500*	84'-11"	2,200*	65
62	58'-9"	5,400*	64'-11"	4,500*	66'-4"	3,600*	73'-11"	3,500*	82'-10"	2,400*	87'-8"	2,100*	62
59	63'-6"	4,800*	70'-3"	4,000*	72'-3"	3,300*	77'-11"	3,200*	86'-9"	2,300*	91'-3"	2,100*	59
55	69'-9"	4,100*	76'-7"	3,500*	79'-0"	2,900*	83'-8"	2,800*	91'-11"	2,200*	96'-0"	2,100*	55
51	75'-5"	3,100	82'-4"	2,800	84'-8"	2,700*	90'-10"	2,400	97'-11"	2,100	100'-9"	2,000	51
47	80'-8"	2,700	87'-6"	2,300	89'-8"	2,200	97'-2"	1,900	102'-3"	1,700	105'-6"	1,700	47
43	85'-7"	2,200	92'-2"	1,800	94'-1"	1,800	102'-10"	1,500	107'-5"	1,400	110'-3"	1,300	43
38	91'-0"	1,600	97'-8"	1,400	98'-11"	1,400							38

#### NOTES FOR JIB CAPACITIES

- F. For all boom lengths less than the maximum with a jib erected, the rated loads are determined by boom angle only in the appropriate column.
- G. For boom angle not shown, use the capacity of the next lower boom angle.
- H. Listed radii are for fully extended main boom only.

### MAX. PERMISSIBLE HOIST LINE LOAD

MAXIMUM PERMISSIBLE HOIST LINE LOAD							
LINE PARTS	1	2	3	4	5	6	7
MAX. LOAD	9,080	18,160	27,240	36,320	45,400	54,480	65,560
BOOM HEAD	2	2-D	2-3	1-2-D	1-2-3	1-2-3-D	1-2-3-4
HOOK BLOCK	D	2	2-D	1-2	1-2-D	1-2-3	1-2-3-D

WIRE ROPE: 5/8" ROTATION RESISTANT COMPACTED STRAND, 18X19 OR 19X19 MINIMUM BREAKING STRENGTH - 22.7 TONS  
5/8" 6X19 OR 6X37 IWRC IPS PERFORMED RIGHT REGULAR LAY MINIMUM BREAKING STRENGTH - 17.9 TONS

### RECOMMENDED TIRE PRESSURES

TIRE SIZE	STATIONARY	CREEP	2 1/2 MPH	TRAVEL
16:00 X 25-28 PR	115 PSI	115 PSI	95 PSI	80 PSI
20:50 X 25-24 PR	95 PSI	95 PSI	70 PSI	70 PSI

# General Notes

## GENERAL

1. Review Operator's Manual prior to operating this crane.
2. Crane load ratings as determined by boom length, radius, and boom angle apply to this crane only as originally manufactured and equipped. **THEY ARE MAXIMUM LOAD RATINGS.**
3. This crane and its load ratings are in accordance with Power Crane & Shovel Association Standard No. 4, SAE Crane Load Stability Test Code J-765a. SAE Method of Test for Crane Structure J1063 and Safety Code for Cranes, Derricks and Hoists, ANSI B30.5-1982.
4. Improperly operated or maintained equipment can be dangerous. The operator and other personnel should read and fully understand the Operator's Manual furnished by the manufacturer before operating or maintaining this crane. Rules for safe operation of equipment should be adhered to at all times. If either Manuals or a lift chart are missing, these should be ordered by crane serial number through the distributor.
5. Operators and supervisors must fully understand Safety Standards for Mobile Hydraulic Cranes ANSI B30.5 or latest, and be familiar with Federal, State, and local safety regulations.

## SET-UP

6. Crane load ratings are based on the crane being leveled and standing on a firm, uniform supporting surface.
7. Crane load ratings on outriggers are based on all outrigger beams fully extended and the tires raised free of the supporting surface.
8. Crane load ratings on tires depend on appropriate inflation pressure and tire conditions. Caution must be exercised when increasing air pressures in tires. Consult Operator's Manual for precautions.
9. Use of jibs, lattice-type boom extension, or fourth section pullout extended is not permitted for pick and carry operations.
10. Consult appropriate section of the Operator's and Service Manual for more exact description of hoist line reeving.
11. The use of more parts of line than required by the load may result in having insufficient rope to allow the hook block to reach the ground.
12. Properly maintained wire rope is essential to safe crane operation. Consult Operator's Manual for proper maintenance and inspection requirements.
13. When spin-resistant wire rope is used, the allowable rope loading shall be the breaking strength divided by five (5) unless otherwise specified by the wire rope manufacturer.

## OPERATION

14. Crane load ratings must not be exceeded. **DO NOT ATTEMPT TO TIP THE CRANE TO DETERMINE ALLOWABLE LOADS.**
15. Crane load ratings are for lift crane service. Applications for other than lift crane (clamshell and magnet) are permitted. Due to significant variation in materials and applications, consult factory for optimum capability.

16. Weight of hooks, hook blocks, slings and all other load handling devices must be considered part of the load to be handled and must be subtracted from the load ratings to obtain the allowable load to be lifted.
17. Crane load ratings are based on freely suspended loads. **SIDE LOAD ON BOOM OR JIB IS EXTREMELY DANGEROUS.**
18. Practical working loads depend on the supporting surface, wind velocity, pendulum action, jerking or sudden stopping of loads, hazardous surroundings, experience of personnel and proper operation, tire inflation, tire condition, traveling with loads, multiple crane lifts, proximity of electrical wires, etc. Appropriate reduction of load ratings must be made for these and any other conditions which may affect practical working loads.
19. Crane load ratings with an asterick (\*) beside them are based on the crane's structure strength. All other ratings are based on stability and do not exceed the specified percentage of tipping load as determined by SAE Crane Stability Test Code J-765a.
20. When either radius or boom length, or both, are between listed values, the smaller of the two load ratings shall be used.
21. Do not operate at longer radii than those listed on the applicable load rating chart as tipping can occur without a load on the hook.
22. Power telescoping boom sections must be extended equally.
23. Load ratings are dependent upon the crane being maintained according to manufacturer's specifications.
24. The maximum load which may be telescoped is limited by boom angle, hydraulic pressure, boom lubrication, etc. It is safe to attempt to extend and retract within the limits to the capacity chart.
25. It is recommended that load handling devices, including hooks, and hook blocks, be kept away from boom head at all times.
26. The boom angles shown on the capacity chart give an approximation of the operating radius for a specified boom length. The boom angle, before loading, should be greater to account for boom deflection. It may be necessary to retract the boom if maximum boom angle is insufficient to maintain rated radius.
27. For MCH carrier-mounted cranes only: 360° capacities apply only to machine equipped with front outrigger jack with all five (5) outrigger jacks properly set. For 360° lift capacities, use Over Side capacity chart.

## DEFINITIONS

28. Operating Radius: The horizontal distance from the axis of rotation before loading to the center of the vertical hoist line or tackle with a load applied.
29. Freely Suspended Load: Load hanging free with no direct external force applied except by the hoist rope.
30. Side Load: Horizontal force applied to the lifted load either on the ground or in the air.
31. Working Area: Areas measured in a circular arc around the centerline of rotation as shown on the working area diagram.

WE RESERVE THE RIGHT TO AMEND THESE SPECIFICATIONS AT ANY TIME WITHOUT NOTICE. THE ONLY WARRANTY APPLICABLE IS OUR STANDARD WRITTEN WARRANTY APPLICABLE TO THE PARTICULAR PRODUCT AND SALE. WE MAKE NO OTHER WARRANTY, EXPRESSED OR IMPLIED.



Koehring Cranes & Excavators  
Waverly, Iowa 50677