

**ROUGH TERRAIN  
RT440B****FEATURES**

- ▶ 40 tons (36 mt) maximum lifting capacity
- ▶ 123' (37.4 m) maximum boom length
- ▶ 128' (39 m) maximum tip height
- ▶ Five-section full power boom with single lever control
- ▶ Swingaway jib offsettable 0°, 20° or 40°
- ▶ Two-speed main and auxiliary winches
- ▶ Quick-reeving boom head and hook block
- ▶ Fully independent multi-position out and down outriggers
- ▶ Environmental operator's cab optimizes load visibility and productivity
- ▶ Hydraulic joystick control
- ▶ Rated Capacity Indicator
- ▶ Easy to read load chart books include range diagrams
- ▶ Twelve month or 2,000 hour crane warranty and five year or 10,000 hours warranty on major weldments

**RT440B****ROUGH TERRAIN CRANES**

Max. Lifting Capacity: 44 tons (40 mt)

**FEATURES**

- ▶ High strength, ovoidal design to optimize weight.
- ▶ Single boom hoist cylinder provides boom elevation of -2° to 78° for easier reeving changes and close radius operation.
- ▶ Quick-reeving boom head; no need to remove wedge and socket from rope.
- ▶ 360° house lock standard.

**ENVIRONMENTAL OPERATOR'S CAB**

- ▶ Rated Capacity Indicator (RCI) system including anti-two block system with automatic function disconnects.
- ▶ Deluxe six-way adjustable operator's seat has mechanical suspension and adjustable head and arm rests.
- ▶ Sound and weather insulated for comfort.
- ▶ Upper and rear hinged window, front and upper anti-breaking window.
- ▶ Armrest mounted dual axis controls for winch(s), swing, boom elevation and boom telescope; foot control pedal for throttle.
- ▶ Cab heater and A/C.
- ▶ Complete instrumentation.
- ▶ External, centralized, easy accessible electric panel.

**RUGGED EASY TO MANEUVER CARRIER**

- ▶ Box-type chassis construction with reinforcing cross members.
- ▶ Chassis is Terex designed and built with 4 x 4 x 4 drive.
- ▶ Full power-shift transmission with integral torque converter; neutral safety start; three + three speeds forward and reverse.
- ▶ Hydraulic four-wheel power steering for two-wheel, four-wheel or crab steer.
- ▶ Split system air over hydraulic drum brakes on all four wheels.
- ▶ Fully independent hydraulic outriggers may be utilized fully extended to 19.03' (5.83 m), in their half extended position or fully retracted, with steel pads.
- ▶ Tail swing only 143" (3.63 m).



- ▶ Standard QSB 6.7 160HP (119KW) Tier-III compliant Cummins diesel engine.
- ▶ 79 gal (300 L) fuel tank.
- ▶ Earthmover style 20.50 x 25 P.R. tires standard.

**POWERFUL, TWO-SPEED MAIN & AUXILIARY WINCHES, STANDARD**

- ▶ 220 fpm (67 m/min) maximum line speed, 13,938 lb (6,200 kg) maximum line pull, 10,116 lb (4,500 kg) permissible line pull.
- ▶ Integral automatic brake.
- ▶ Winch drum rollers.

**HIGH CAPACITY, DEPENDABLE HYDRAULIC SYSTEM**

- ▶ Two tandem gear pumps driven off the transmission. Combined system capability is 100 gpm (450 lpm).
- ▶ Hydraulic reservoir with 92 gal (420 L) capacity and full flow oil filtration system.

**STANDARD FEATURES INCLUDE**

26' (8 m) swing-on jib, offset 0°, 20° or 40° • Air conditioner  
• Cold weather starting aid • Work lights • Revolving amber light, 360° spotlight • Pintle hook front • Tire inflation kit

**TEREX Cranes**  
106-12th Street S.E.  
Waverly, Iowa 50677-9466 USA

TEL (319) 352-3920 FAX (319) 352-5727  
EMAIL [inquire@terexwaverly.com](mailto:inquire@terexwaverly.com)  
WEB [terex.com](http://terex.com)

WE RESERVE THE RIGHT TO AMEND THESE SPECIFICATIONS AT ANY TIME WITHOUT NOTICE. THE ONLY WARRANTY APPLICABLE IS OUR STANDARD WRITTEN WARRANTY APPLICABLE TO THE PARTICULAR PRODUCT AND SALE.

WE MAKE NO OTHER WARRANTY, EXPRESSED OR IMPLIED.

©TEREX CRANES, INC 2005

PRINTED IN U.S.A.

MAY 25, 2007

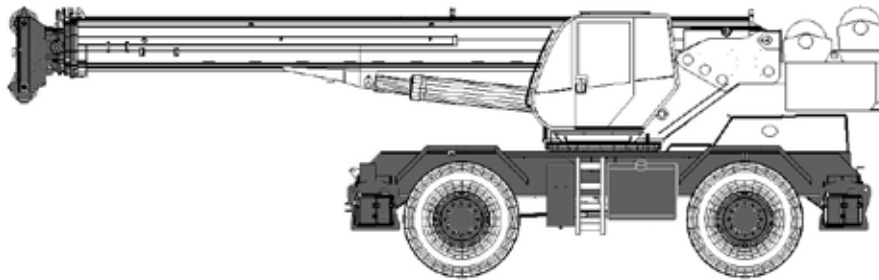

## STANDARD BOOM EQUIPMENT

### BOOM

31-123' (9.5-37.4 m), five section full power boom. Element 2 slides out regardless of the other elements; elements 3, 4 and 5 slide out in a proportional and continuous way. Extension cylinder with two independent strokes, rope drive system.

Extension under partial load possible. The boom is a high-strength octagonal design, welded out on the neutral axis, with anti-friction slide pads.

A single boom hoist cylinder provides for boom elevation of  $-2^{\circ}$  to  $78^{\circ}$ . Maximum tip height 128' (39 m).

### BOOM HEAD

Welded to fifth section of boom. Five resin load sheaves and one idler sheaves mounted on heavy duty, anti-friction bearings.

Quick reeving boom head. Provision made for side-stow jib mounting.

## OPTIONAL BOOM EQUIPMENT

### JIBS

Jibs feature easy installation/stowage through use of spear type stowage system. Jibs utilize a single resin sheave mounted on anti-friction bearing. Jibs are quickly offsettable at  $0^{\circ}$ ,  $20^{\circ}$  or  $40^{\circ}$  by relocating two pins. 26' (8 m) side stow swing-on one piece boxed type jib. Maximum tip height is 154' (47 m).

### AUXILIARY BOOM HEAD

Removable auxiliary boom head has single metallic sheave mounted on anti-friction bearing. Removable pin-type rope guard for quick reeving. Installs on main boom peak only. Removable is not required for jib use.

### HOOK BLOCK

Five plastic sheaves on anti-friction bearings with hook and hook latch. Quick reeving design does not require removal of wedge and socket from rope.

### HOOK AND BALL

5,5 ton (5 mt) top swivel ball with hook and hook latch.

## STANDARD UPPERSTRUCTURE EQUIPMENT

### UPPERSTRUCTURE FRAME

All welded one-piece structure fabricated with high tensile strength alloy steel. Counterweight is bolted to frame.

### TURNTABLE CONNECTION

Swing bearing is a double row, ball type, with internal teeth. The swing bearing is bolted to the revolving upperstructure and to the carrier frame.

### SWING

A hydraulic motor drives a double planetary reduction gear for precise and smooth swing function. Swing speed (no load) is two rpm.

### SWING BRAKE

Heavy duty multiple disc swing brake. Negative type: spring applied, hydraulically automatically released. Brake electro-hydraulic release for direct alignment of boom along load vertical line. Manually operated 360° mechanical house lock is standard.

### RATED CAPACITY INDICATOR

Rated Capacity Indicator with visual and audible warning system and automatic function disconnects. Display includes: boom radius, boom angle, boom length, allowable load, actual load and percentage of allowable load. Operator settable alarms provided for swing angle, boom length, boom angle, tip height and work area exclusion zone. Anti-two block system includes audio/visual warning and automatic function disconnects.

### OPERATORS CAB

Environmental cab with all steel construction, optimum visibility, tinted safety glass throughout and rubber floor matting. The cab has a sliding door on the left side, window on the right side, Upper and rear hinged window, front and upper anti-breaking window. Acoustical foam padding insulates against sound and weather. The deluxe six-way adjustable seat is equipped with a mechanical suspension and includes head and arm rests.



### CONTROLS

All control levers and pedals are positioned for efficient operation. Armrest mounted dual axis controls for winch(s), swing, boom elevation and boom telescope. Armrest swings up to improve access and egress. Steering column mounted turn signal, wiper, and horn controls. Dashboards include ignition, engine stop, lights, cab AC and heater, steering mode, parking brake, outriggers, telescope mode. Horn and swing brake release switches are mounted in the levers. Foot control pedals include service brake and accelerator.

### INSTRUMENTATION AND ACCESSORIES

In-cab gauges include air pressure, bubble level, fuel, engine coolant temperature. Indicators include low air, low engine oil pressure, high transmission temperature and Rated Capacity Indicator. Accessories include fire extinguisher; light package including headlights, tail light, brake lights, directional signals, four-way hazard flashers, dome light and backup lights with audible backup alarm; windshield washer/wiper; skylight wipers; R.H. and L.H. rear view mirrors; dash lights; and seat belt. Circuit breakers protect electrical circuits.

### HYDRAULIC CONTROL VALVES

Valves are mounted on the side of the upperstructure and are easily accessible. Valves have hydraulic operators and include one two spool valve for main and auxiliary winch and one three spool valve for boom movements together with one single spool valve for swing. Quick disconnects are provided for ease of installation of pressure check gauges

### STANDARD EQUIPMENT

Auxiliary Winch, Electro-hydraulic Heater, hydraulically powered Air Conditioner, Hour counter, Work Lights, Rotating Beacon.

## STANDARD CARRIER EQUIPMENT

### CARRIER CHASSIS

Chassis is Terex designed with four-wheel drive and four-wheel steer (4X4X4). Has box-type construction with reinforcing cross members, a precision machined turn table mounting plate and integrally welded outrigger boxers. Decking has antiskid surfaces, including between the frame rails lockable front tool storage compartment and access steps and handles on the left and right sides and on the front left and the rear right corners.

### AXLES AND SUSPENSION

Rear axle is a planetary drive/steer type, oscillating mounted on the frame. Automatic oscillation lockouts that engage when the superstructure is swung 3° in either direction. Front axle is a planetary drive/steer type, rigid mounted to the frame for increased stability.

### STEERING

Hydraulic four-wheel full power steering for two-wheel, fourwheel coordinated, or four-wheel crab steer is easily controlled by steering wheel. A rear axle centering light is provided.



	<b>Turning Radius: (to CL of outside tire)</b>	<b>Curb Clearance Radius</b>
Two-wheel:	41' (12,5 mt)	29' 62" (9 mt)
Four-wheel:	22' 12" (7 mt)	14' 91" (4,5 mt)

### TRANSMISSION

Range-shift type power-shift transmission with integral torque converter has neutral safety start, three+three speeds forward and three+three speeds reverse provides wide ratio coverage. Automatic pulsating backup alarm.



## STANDARD CARRIER EQUIPMENT (CONTINUED)

### MULTI-POSITION OUT AND DOWN OUTRIGGERS

Fully independent hydraulic outriggers may be utilized fully extended to 19' 03" (5.83 m) centerline to centerline, in their 1/2 extended position or fully retracted for maximum flexibility. Easily removable steel floats, each with an area of 336 in<sup>2</sup> (2165 cm<sup>2</sup>), stow in the front of the outrigger boxes near their point of use. Complete controls and a sight leveling bubble are located in the operator's cab.

### WHEELS AND TIRES

Disk type wheels with full tapered bead seat rim. 143" (3.62 m) wheelbase.

## HYDRAULIC SYSTEM

### HYDRAULIC PUMPS

Two tandem gear type pumps. Combined system capability is 100 gpm (458 lpm).

- ▶ **Main winch pump**
- ▶ 40 gpm (180 lpm) @ 3,046 psi (214 kg/cm<sup>2</sup>)
- ▶ **Boom Hoist and Telescope Pump**
- ▶ 24 gpm (109 lpm) @ 4,206 psi (296 kg/cm<sup>2</sup>)
- ▶ **Power Steering and Winch Boost Pump**
- ▶ 18 gpm (82 lpm) @ 2,176 psi (153 kg/cm<sup>2</sup>)
- ▶ **Outrigger and Swing Pump**
- ▶ 19 gpm (86 lpm) @ 2,321 psi (163 kg/cm<sup>2</sup>)

### MAIN WINCH SPECIFICATIONS

Hydraulic winch with bent axis piston and planetary reduction gearing provides two-speed operation with equal speeds for power up and down. Winch is equipped with an integral automatic brake, smooth drum and standard cable roller on drum.

Performance	LO-Range	HI-Range
▶ Max line speed (no load)		
▶ First Layer	151 fpm (46 m/min)	223 fpm (68 m/min)
▶ Fifth Layer	210 fpm (64 m/min)	308 fpm (94 m/min)
<hr/>		
▶ Max. line pull-first layer	13,938 lb (6 200kg)	9,892 lb (4 400 kg)
▶ Max. line pull-fifth layer	10,116 lb (4 500 kg)	6,969 lb (3 100 kg)
▶ Permissible line pull	10,116 lb (4 500 kg)	

Drum Dimensions	Drum Capacity
▶ 12.8" (324 mm) drum diameter	Max. Storage: 623' (190 m) on 5th layer
▶ 18.6" (472 mm) length	
▶ 21.1" (535 mm) flange dia.	
▶ Cable: 5/8" x 607' (16 mm x 185 m)	
▶ Cable type: 5/8" x (16 mm) 27WxK7, right lang lay	

### OPTIONAL AUXILIARY WINCH

Hydraulic 2-speed winch with bent axis piston motor, equal speed power up and down, planetary reduction with integral automatic brake, smooth drum and drum roller.

Performance	
▶ Max. line speed (no load) Fifth layer	354 fpm (108 m/min)
▶ Max. line pull First layer	11,240 lb (5 000 kg)
▶ Permissible line pull	8,543 lb (3 800 kg)

### TIRES

Wide earthmover (E3) style tread tires provide life and flotation. 20.5x25 P.R

### SERVICE BRAKES

Split system air over hydraulic brakes on all four wheels, 20"x4.7" drum brakes on all wheels.

### PARKING BRAKE

Front axle equipped with spring-set, air released emergency/ parking brake.

### FILTRATION

Full flow oil filtration system with bypass protection includes 25 micron replaceable return line filter.

### HYDRAULIC RESERVOIR

All steel, welded construction with internal baffles and a diffuser. Provides easy access to filters and is equipped with an external sight level gauge. Capacity is 92 gal (420 L). Hydraulic oil cooler is standard.

### ENGINE SPECIFICATIONS

- ▶ Make and Model Cummins QSB 6.7
- ▶ Type 6 cylinder
- ▶ Displacement 409 cubic inches (6.7L)
- ▶ Rated HP 160 hp (119 kw) @ 2200 rpm
- ▶ Rated Torque 540 lb•ft (732 N•m) @ 1400 rpm
- ▶ Aspiration turbocharged & charge air cooled
- ▶ Air Filter dry type
- ▶ Electrical System 24 volt
- ▶ Alternator 70 amp
- ▶ Battery (2) 12V 200Ah 850A
- ▶ Fuel Capacity 79 gal (300 L)

### PERFORMANCE (STANDARD ENGINE)

Transmission Gear	Forward Drive	Max. Speed	Max. Tractive Effort	Gradeability @ Stall
▶ Low 1	4-wheel	1.8 mph (2.9 kph)	44,805 lb (20 323 kg)	101.1%
▶ Low 2	4-wheel	3.5 mph (5.7 kph)	22,769 lb (10 328 kg)	37.5%
▶ Low 3	4-wheel	10.4 mph (16.8 kph)	7,593 lb (3 444 kg)	10.4%
▶ High 1	2-wheel	4.0 mph (6.5 kph)	20,007 lb (9 075 kg)	32.2%
▶ High 2	2-wheel	7.9 mph (12.7 kph)	10,168 lb (4 612 kg)	14.7%
▶ High 3	2-wheel	21.1 mph (34.0 kph)	3,391 lb (1 538 kg)	3.5%

All performance data is based on a gross vehicle weight of 60,847 lb (27600 kg). 20.5R25 tires, 4x4 drive. Performance may vary due to engine performance. Gradeability data is theoretical and is limited by tire slip, machine stability, or oil pan design.

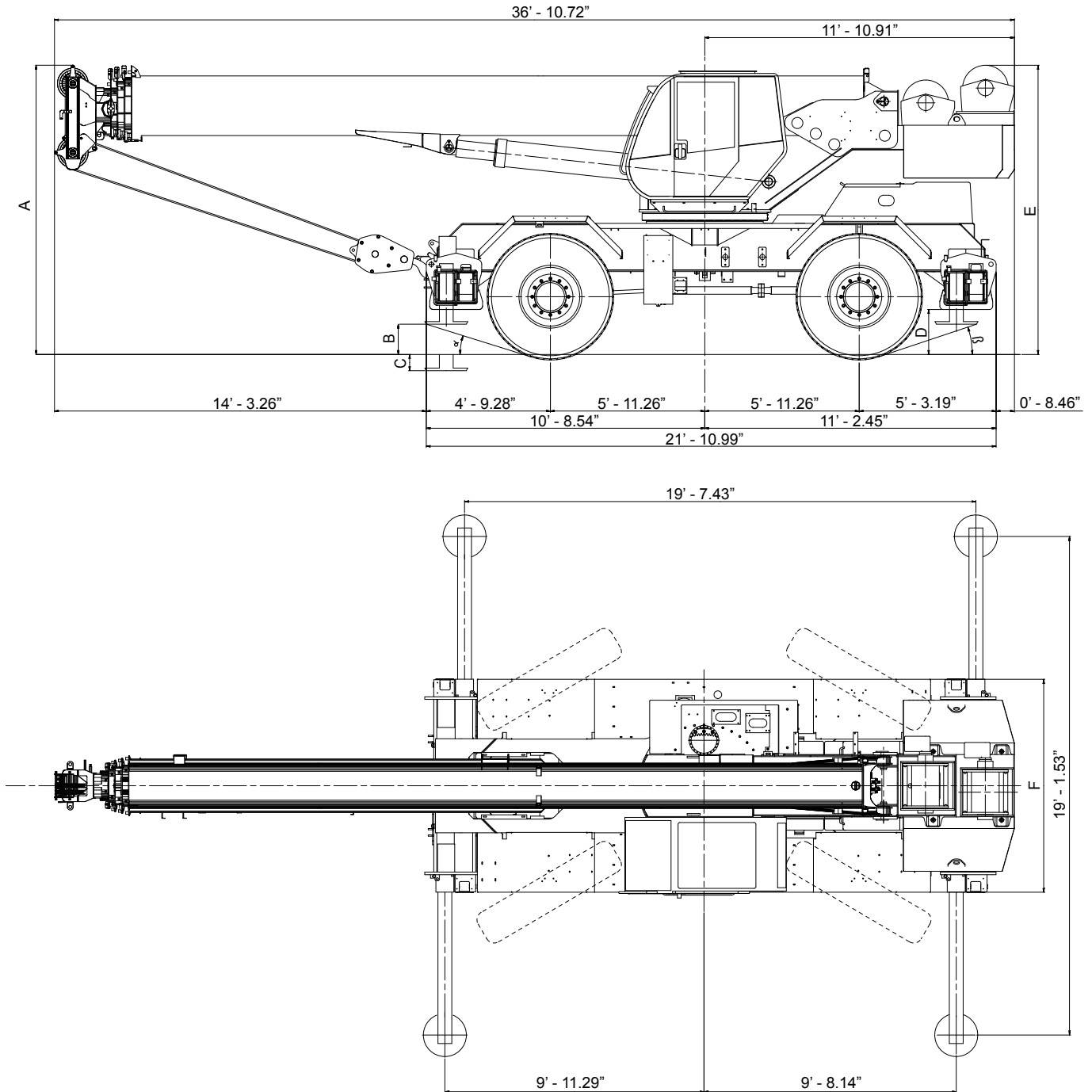
**GENERAL DIMENSIONS**

WEIGHTS & AXLE LOADS	GROSS WEIGHT LB	UPPER FACING FRONT		GROSS WEIGHT KG	UPPER FACING FRONT	
		FRONT	REAR		FRONT	REAR
Base Crane with 12,125 lb (5500 Kg) Counterweight	61,290	26,455	34,835	27,800	12,000	15,800
<b>Add options:</b> 26' *8 m( Swing/on Jib (Stowed)	+880	+1,565	-685	+400	+710	-310

## Range Diagram and Lifting Capacity | RT440B

### 44 TON LIFTING CAPACITY

### RANGE DIAGRAM 31' - 123' BOOM

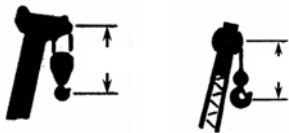

Dimensions are for largest factory furnished hook block and hook & ball, with anti-two block activated.

COUNTERWEIGHT	W/AUX. WINCH 12,125 LB
BOOM LENGTH	31'-123'
OUTRIGGER SPREAD	19'
STABILITY PERCENTAGE	ON OUTRIGGERS 85% ON TIRES 75%
PCSA CLASS	10-210

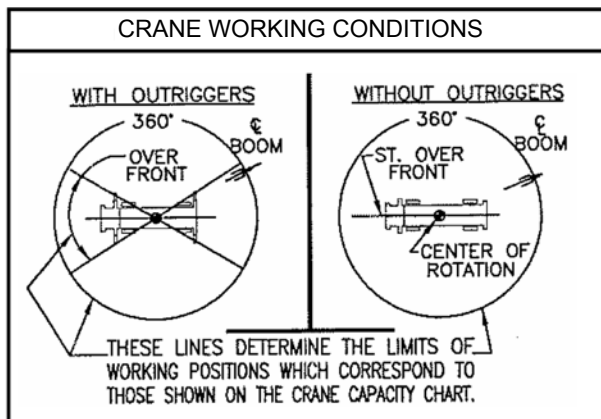
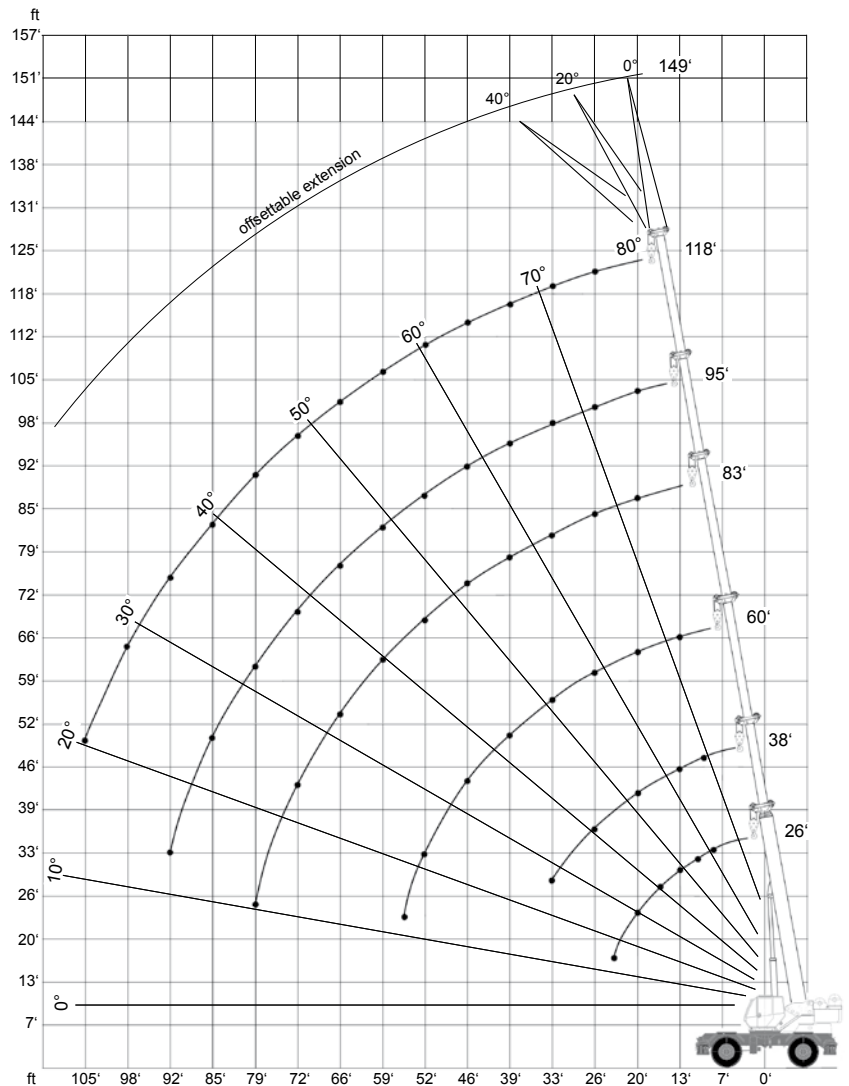

### REDUCTION IN MAIN BOOM CAPACITY

26' jib in stowed position 770 lb

### HOOK BLOCK WEIGHTS

Hook and ball	239 lb
25T hook block (4 sheave)	690 lb
30T hook block (5 sheave)	888 lb
40T hook block (6 sheave)	913 lb

**LIFTING CAPACITIES**

CAUTION: Do not use this specification sheet as a load rating chart. The format of data is not consistent with the machine chart and may be subject to change.

**ON OUTRIGGERS FULLY EXTENDED**

 USE THESE CHARTS **ONLY**  
 WHEN ALL OUTRIGGERS ARE  
 FULLY EXTENDED

Load Radius (FT)	Boom length 31'			Boom length 43'			Boom length 54'			Boom length 65'			Boom length 77'			Load Radius (FT)
	Boom angle	Over front (LB)	360° (LB)	Boom angle	Over front (LB)	360° (LB)	Boom angle	Over front (LB)	360° (LB)	Boom angle	Over front (LB)	360° (LB)	Boom angle	Over front (LB)	360° (LB)	
10	61.1	<b>80000</b>	<b>80000</b>	69.5	<b>80000</b>	<b>80000</b>	74.0	<b>57200</b>	<b>57200</b>	76.8	<b>50200</b>	<b>50200</b>				10
12	57.5	<b>78700</b>	<b>78700</b>	67.1	<b>73500</b>	<b>73400</b>	72.2	<b>52200</b>	<b>52200</b>	75.3	<b>46200</b>	<b>46200</b>	77.6	<b>41600</b>	<b>41600</b>	12
15	49.6	<b>67000</b>	<b>67000</b>	62.1	<b>63200</b>	<b>63200</b>	68.5	<b>45000</b>	<b>45000</b>	72.2	<b>39500</b>	<b>39500</b>	75.1	<b>35800</b>	<b>35800</b>	15
20	35.2	<b>55100</b>	<b>52900</b>	54.1	<b>51800</b>	<b>48500</b>	62.7	<b>36900</b>	<b>36800</b>	67.6	<b>32400</b>	<b>32400</b>	71.3	<b>29300</b>	<b>29300</b>	20
25				41.7	<b>30400</b>	<b>28600</b>	54.3	<b>29300</b>	<b>28600</b>	61.0	<b>25600</b>	<b>26800</b>	66.0	<b>23200</b>	<b>23200</b>	25
30				34.0	<b>23500</b>	<b>23300</b>	49.8	<b>22900</b>	<b>22000</b>	57.6	<b>23200</b>	<b>21800</b>	63.3	<b>21000</b>	<b>21000</b>	30
35							39.5	<b>15600</b>	<b>15400</b>	50.3	<b>16500</b>	<b>14900</b>	57.6	<b>16900</b>	<b>15900</b>	35
40							33.4	<b>13000</b>	<b>12700</b>	46.3	<b>14100</b>	<b>12700</b>	54.6	<b>14500</b>	<b>13600</b>	40
45							14.8	<b>9200</b>	<b>8800</b>	37.3	<b>10100</b>	<b>9200</b>	48.2	<b>11000</b>	<b>10100</b>	45
50										32.0	<b>9000</b>	<b>7900</b>	44.8	<b>9200</b>	<b>8800</b>	50
55										17.1	<b>6500</b>	<b>5900</b>	37.1	<b>7200</b>	<b>6800</b>	55
60													32.7	<b>6300</b>	<b>5900</b>	60
65													21.4	<b>4800</b>	<b>4600</b>	65
70													12.1	<b>4400</b>	<b>4100</b>	70
75																75
80																80
85																85
90																90
95																95
100																100
105																105
110																110
△°	0°	<b>28600</b>	<b>28600</b>	0°	<b>13200</b>	<b>13200</b>	0°	<b>6600</b>	<b>6600</b>	0°	<b>4400</b>	<b>4400</b>	0°	<b>3000</b>	<b>3000</b>	△°





**LIFTING CAPACITIES** CAUTION: Do not use this specification sheet as a load rating chart. The format of data is not consistent with the machine chart and may be subject to change.

**ON OUTRIGGERS FULLY EXTENDED**



USE THESE CHARTS **ONLY**  
WHEN ALL OUTRIGGERS ARE  
PINNED IN MID POSITION



Load Radius (FT)	Boom length 88'			Boom length 100'			Boom length 112'			Boom length 123'			Load Radius (FT)
	Boom angle	Over front (LB)	360° (LB)	Boom angle	Over front (LB)	360° (LB)	Boom angle	Over front (LB)	360° (LB)	Boom angle	Over front (LB)	360° (LB)	
10													10
12													12
15	78.1	<b>31800</b>	<b>31800</b>										15
20	73.7	<b>26800</b>	<b>26800</b>	75.7	<b>22000</b>	<b>22000</b>							20
25	69.1	<b>21400</b>	<b>21400</b>	71.8	<b>19400</b>	<b>19400</b>	73.8	<b>16400</b>	<b>16400</b>	75.2	<b>12200</b>	<b>12200</b>	25
30	66.8	<b>19200</b>	<b>19200</b>	69.8	<b>17600</b>	<b>17600</b>	72.0	<b>15500</b>	<b>15500</b>	73.6	<b>11700</b>	<b>11700</b>	30
35	62.0	<b>16000</b>	<b>14700</b>	65.7	<b>14600</b>	<b>14600</b>	68.4	<b>13500</b>	<b>13500</b>	70.4	<b>10200</b>	<b>10200</b>	35
40	59.5	<b>14700</b>	<b>13900</b>	63.6	<b>13500</b>	<b>13400</b>	66.6	<b>12600</b>	<b>12600</b>	68.8	<b>9700</b>	<b>9700</b>	40
45	54.3	<b>11000</b>	<b>10400</b>	59.2	<b>11600</b>	<b>10800</b>	62.8	<b>10900</b>	<b>10900</b>	65.4	<b>8700</b>	<b>8700</b>	45
50	51.6	<b>9900</b>	<b>9200</b>	57.0	<b>10300</b>	<b>9500</b>	60.9	<b>10100</b>	<b>9900</b>	63.7	<b>8100</b>	<b>8100</b>	50
55	45.8	<b>7400</b>	<b>7200</b>	52.3	<b>7700</b>	<b>7600</b>	56.9	<b>8200</b>	<b>7800</b>	60.2	<b>13700</b>	<b>7000</b>	55
60	42.7	<b>6800</b>	<b>6300</b>	49.9	<b>6800</b>	<b>6800</b>	54.9	<b>7400</b>	<b>7000</b>	58.4	<b>6700</b>	<b>6800</b>	60
65	35.7	<b>5400</b>	<b>4900</b>	44.7	<b>5700</b>	<b>5500</b>	50.6	<b>6100</b>	<b>5700</b>	54.7	<b>5900</b>	<b>5900</b>	65
70	31.7	<b>4800</b>	<b>4200</b>	41.9	<b>5000</b>	<b>4900</b>	48.4	<b>5500</b>	<b>5100</b>	52.8	<b>5200</b>	<b>5500</b>	70
75	21.8	<b>3700</b>	<b>3400</b>	35.7	<b>3900</b>	<b>3700</b>	43.6	<b>4400</b>	<b>3900</b>	48.8	<b>4600</b>	<b>4200</b>	75
80	14.4	<b>2800</b>	<b>2900</b>	32.3	<b>3500</b>	<b>3300</b>	41.1	<b>3900</b>	<b>3500</b>	46.7	<b>4100</b>	<b>3800</b>	80
85				24.0	<b>2700</b>	<b>2400</b>	35.5	<b>2900</b>	<b>2700</b>	42.2	<b>3100</b>	<b>2900</b>	85
90				18.6	<b>2400</b>	<b>2000</b>	32.4	<b>2600</b>	<b>2400</b>	39.8	<b>2800</b>	<b>2600</b>	90
95							25.2	<b>2000</b>	<b>1700</b>	34.7	<b>2200</b>	<b>1900</b>	95
100							14.9	<b>1800</b>	<b>1500</b>	28.7	<b>1900</b>	<b>1700</b>	100
105										25.2	<b>1500</b>	<b>1200</b>	105
110										**	**	**	110
	0°	<b>2000</b>	<b>2000</b>	0°	<b>1300</b>	<b>1300</b>	0°	<b>800</b>	<b>800</b>	25°	<b>1300</b>	<b>900</b>	

**LIFTING CAPACITIES**

CAUTION: Do not use this specification sheet as a load rating chart. The format of data is not consistent with the machine chart and may be subject to change.

**ON OUTRIGGERS MID POSITION**

USE THESE CHARTS ONLY  
WHEN ALL OUTRIGGERS ARE  
PINNED IN MID POSITION

Load Radius (FT)	Boom length 31'		Boom length 43'		Boom length 54'		Boom length 65'		Boom length 77'		Load Radius (FT)
	Boom angle	360° (LB)	Boom angle	360° (LB)	Boom angle	360° (LB)	Boom angle	360° (LB)	Boom angle	360° (LB)	
10	61.1	<b>65600</b>	69.5	<b>63900</b>	74.0	<b>57200</b>	76.8	<b>50200</b>			10
12	57.5	<b>45100</b>	67.1	<b>44000</b>	72.2	<b>44000</b>	75.3	<b>45100</b>	77.6	<b>41600</b>	12
15	49.6	<b>27700</b>	62.1	<b>26400</b>	68.5	<b>26400</b>	72.2	<b>27500</b>	75.1	<b>28600</b>	15
20	35.2	<b>15800</b>	54.1	<b>14900</b>	62.7	<b>14700</b>	67.6	<b>15800</b>	71.3	<b>16500</b>	20
25			41.7	<b>8100</b>	54.3	<b>7700</b>	61.0	<b>8500</b>	66.0	<b>9700</b>	25
30			34.0	<b>6100</b>	49.8	<b>5700</b>	57.6	<b>6800</b>	63.3	<b>7400</b>	30
35					39.5	<b>2200</b>	50.3	<b>3900</b>	57.6	<b>4600</b>	35
40					33.4	<b>1900</b>	46.3	<b>2800</b>	54.6	<b>3700</b>	40
45					**	**	37.3	<b>1500</b>	48.2	<b>2200</b>	45
50							32.0	<b>800</b>	44.8	<b>1500</b>	50
55							**	**	**	**	55
60											60
65											65
70											70
75											75
80											80
85											85
90											90
95											95
100											100
105											105
110											110
	0°	<b>10200</b>	0°	<b>3400</b>	**	**	**	**	**	**	



## LIFTING CAPACITIES

CAUTION: Do not use this specification sheet as a load rating chart. The format of data is not consistent with the machine chart and may be subject to change.

### ON OUTRIGGERS MID POSITION



USE THESE CHARTS ONLY  
WHEN ALL OUTRIGGERS ARE  
PINNED IN MID POSITION

Load Radius (FT)	Boom length 88'		Boom length 100'		Boom length 112'		Boom length 123'		Load Radius (FT)
	Boom angle	360° (LB)	Boom angle	360° (LB)	Boom angle	360° (LB)	Boom angle	360° (LB)	
10									10
12									12
15	78.1	<b>30500</b>							15
20	73.7	<b>17400</b>	75.7	<b>17600</b>					20
25	69.1	<b>10300</b>	71.8	<b>10500</b>	73.8	<b>11000</b>	75.2	<b>11200</b>	25
30	66.8	<b>8100</b>	69.8	<b>8300</b>	72.0	<b>8800</b>	73.6	<b>9000</b>	30
35	62.0	<b>5000</b>	65.7	<b>5500</b>	68.4	<b>5700</b>	70.4	<b>6000</b>	35
40	59.5	<b>4100</b>	63.6	<b>4400</b>	66.6	<b>4800</b>	68.8	<b>5000</b>	40
45	54.3	<b>2600</b>	59.2	<b>2800</b>	62.8	<b>3300</b>	65.4	<b>3500</b>	45
50	51.6	<b>1900</b>	57.0	<b>2300</b>	60.9	<b>2600</b>	63.7	<b>2800</b>	50
55	45.8	<b>900</b>	52.3	<b>1200</b>	56.9	<b>1600</b>	60.2	<b>1800</b>	55
60	**	**	**	**	54.9	<b>1100</b>	58.4	<b>1400</b>	60
65					**	**	56.6	<b>1100</b>	65
70							**	**	70
75									75
80									80
85									85
90									90
95									95
100									100
105									105
110									110
	**	**	**	**	**	**	**	**	



## LIFTING CAPACITIES

CAUTION: Do not use this specification sheet as a load rating chart. The format of data is not consistent with the machine chart and may be subject to change.

### ON TIRES 20.5R25

Load Radius (FT)	Max Boom Length (FT)	On Tires 20.5R25			Load Radius (FT)
		Static	static	2.5 MPH	
		360°	Over front	Over front	
10	31	17600	<b>30800</b>	<b>22300</b>	10
12	31	14800	<b>26400</b>	<b>19900</b>	12
15	43	12400	<b>19900</b>	<b>16000</b>	15
20	43	8400	<b>16000</b>	<b>12100</b>	20
25	43	5400	<b>13200</b>	<b>9400</b>	25
30	43	4200	<b>11200</b>	<b>7700</b>	30
35	54		<b>8200</b>	<b>5700</b>	35
40	54		<b>6900</b>	<b>4700</b>	40
45	54		<b>4700</b>	<b>3300</b>	45
50					50
55					55
60					60

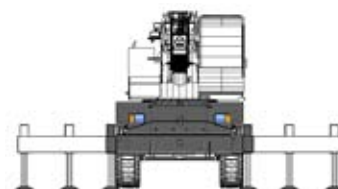

USE THESE CHARTS ONLY WHEN ALL OUTRIGGERS ARE FULLY RETRACTED

### RECCOMENDED TIRE PRESSURE

Tire Size	Make/Model	Type	Stationary	2.5 MPH	Travel
20.5R25	"TRIANGLE" 177B/193 A2	Radial	83PSI	83PSI	65PSI
20.5R25	"MICHELIN" XADN 177B TL	Radial	80PSI	80PSI	80PSI

### MAXIMUM PERMISSIBLE HOIST LINE LOAD

Line Parts	1	2	3	4	5	6	7	8	9	10
Main Hoist	10116	20233	30349	40466	50582	60698	70815	80931	91048	101164
Auxiliary Hoist	8543	17086	25429	34172	42714	51256	59799	68342	76885	85427

MAIN HOIST WIRE ROPE: 5/8" ROTATION RESISTANT 27WxK7, MINIMUM BREAKING STRENGTH 50580 Lb. RIGHT LANG LAY.  
 AUXILIARY HOIST WIRE ROPE: 5/8" ROTATION RESISTANT 27Wx7, MINIMUM BREAKING STRENGTH 42715 Lb. RIGHT LANG LAY.



ROUGH TERRAIN CRANE

**RT440B**



**General Notes | RT440B****GENERAL**

1. Rated loads as shown on Lift Charts pertain to this machine as originally manufactured and equipped. Modifications to the machine or use of optional equipment or other than that specified can result in a reduction of capacity.
2. Construction equipment can be hazardous if improperly operated or maintained. Operation and maintenance of this machine shall be in compliance with the information in the Operator's, Parts and Safety Manuals supplied with this machine. If These manuals are missing, order replacements from the manufacturer through your distributor.
3. These warnings do not constitute all of the operating conditions for the crane. The operator and job site supervision must read the OPERATORS MANUAL, CIMA SAFETY MANUAL, APPLICABLE OSHA REGULATIONS, AND SOCIETY OF MECHANICAL ENGINEERS (ASME) SAFETY STANDINGS FOR CRANES.
4. This crane and its load ratings are in accordance with POWER CRANE & SHOVEL ASSOCIATION, STANDARD NO.4 SAE CRANE LOAD STABILITY TEST CODE J765A, SAE METHOD OF TEST FOR CRANE STRUCTURE J1063 AND APPLICABLE SAFETY CODE FOR CRANES, DERRICKS AND HOISTS, ASME/ANSI B30.5

**DEFINITIONS**

1. **LOAD RADIUS** - The horizontal distance from the axis of rotation before loading to the center of the vertical hoist line or tackle with a load applied.
2. **LOADED BOOM ANGLE** - It is the angle between the boom base section and the horizontal, after lifting the rated load at the rated radius. The boom angle before loading should be greater to account for deflections. The loaded boom angle combined with boom length give only an approximation of the operating radius.
3. **WORKING AREA** - Areas measured in a circular arc about the centerline of rotation as shown in the diagram.
4. **FREELY SUSPENDED LOAD** - Load hanging free with no direct external force applied except by the hoist rope.
5. **SIDE LOAD** - Horizontal force applied to the lifted load either on the ground or in the air.
6. **NO LOAD STABILITY LIMIT** - The stability limit radius shown on the range diagrams is the radius beyond which it is not permitted to position the boom, when the boom angle is less than the minimum shown on the applicable load chart, because the machine can overturn without any load.
7. **BOOM SIDE OF CRANE** - The side of the crane over which the boom is positioned when in OVER SIDE working position.

**SET-UP**

1. Crane load ratings are based on the crane being leveled and standing on a firm, uniform supporting surface.
2. Crane load ratings on outriggers are based on all outrigger beams being fully extended or in the case of partial extension ratings mechanically pinned in the appropriate position, and the tires free of the supporting surface.
3. Crane load ratings on tires depend on appropriate inflation pressure and the tire conditions. Caution must be exercised when increasing air pressures in tires. Consult Operator's Manual for precautions.
4. Use of jibs, lattice-type boom extensions, or fourth section pullouts extended is not permitted for pick and carry operations.
5. Consult appropriate section of the Operator's and Service Manual for more exact description of hoist line reeving.
6. The use of more parts of line than required by the load may result in having insufficient rope to allow the hook block to reach the ground.
7. Properly maintained wire rope is essential for safe crane operation. Consult Operator's Manual for proper maintenance and inspection requirements.
8. When spin-resistant wire rope is used, the allowable rope loading shall be the breaking strength divided by five (5), unless otherwise specified by the wire rope manufacturer.
9. Do not elevate the boom above the angle shown in the Lift Charts unless the boom is positioned in-line with the crane's chassis or the outrigger are extended. Failure to observe this warning may result in loss of stability.

**OPERATION**

1. **CRANE LOAD RATINGS MUST NOT BE EXCEEDED. DO NOT ATTEMPT TO TIP THE CRANE TO DETERMINE ALLOWABLE LOADS.**
2. When either radius or boom length, or both, are between listed values, the smaller of the two listed load ratings shall be used.
3. Do not operate at longer radii than those listed on the applicable load rating chart (cross hatched areas shown on range diagrams.)
4. The boom angles shown on the Capacity Chart give an approximation of the operating radius for a specified boom length. The boom angle, before loading, should be greater to account for boom deflection. It may be necessary to retract the boom if maximum boom angle is insufficient to maintain rated radius.
5. Power telescoping boom sections must be extended equally.
6. Rated loads include the weight of hook block, slings, and auxiliary lifting devices. Their weights shall be subtracted from the listed rated load to obtain the net load that can be lifted. When lifting over the jib the weight of any hook block, slings, and auxiliary lifting devices at the boom head must be added to the load. When jibs are erected but unused add two (2) times the weight of any hook block, slings, and auxiliary lifting devices at the jib head to the load.
7. Rated loads do not exceed 85% on outriggers or 75% on tires, of the tipping load as determined by SAE Crane Stability Test Code J765a.
8. Rated loads are based on freely suspended loads. No attempt shall be made to drag a load horizontally on the ground in any direction.
9. The user shall operate at reduced ratings to allow for adverse job conditions, such as: soft or uneven ground, out of level conditions, high winds, side loads, pendulum action, jerking or sudden stopping of loads, hazardous conditions, experience of personnel, two machine lifts, traveling with loads, electric wires, etc. (side pull on boom or jib is hazardous). Derating of the cranes lifting capacity is required when wind speed exceeds 20 MPH. The center of the lifted load must never be allowed to move more than 3" off the center line of the base boom section due to the effects of wind, inertia, or any combination of the two.  
\*\*"Use 2' off the center line of the base boom for a two section boom, 3' for a three section boom, or 4' for a four section boom."
10. The maximum load which can be telescoped is not definable, because of variations in loadings and crane maintenance, but it is permissible to attempt retraction and extension if load ratings are not exceeded.
11. Load ratings are dependent upon the crane being maintained according to manufacturer's specifications.
12. It is recommended that load handling devices, including hooks, and hook blocks, be kept away from boom head at all times.
13. Do not lift with outrigger beams positioned between the fully extended and intermediate (pinned) positions.

**CLAMSHELL, MAGNET, AND CONCRETE BUCKET SERVICE**

1. Weight of clamshell or magnet, plus contents are not to exceed 6,000 lb or 90% of rated lifting capacities, whichever is less. For concrete bucket operation, weight of bucket and load must not exceed 90% of rated lifting capacity.