



Upperworks

➤ Engine

The Cummins QSC8.3 (Tier 3) inline 6-cylinders, electronic fuel injection, water-cooled and turbo-charge diesel engine with a rated power of 183kW(245hp) and a rated speed of 2000rpm; the maximum output torque is 1268N·m(935ft·lb) and the rotation speed at maximum output torque is 1400rpm.

And optional allocation Cummins 6CTAA-250 inline 6-cylinders, water-cooled diesel engine with a rated power of 186kW(249hp) and a rated speed of 2200rpm; the maximum output torque is 1219N·m(899ft·lb) and the rotation speed at maximum output torque is 1300rpm.

The engine is equipped with a diesel oil tank with a capacity of 400L (105.6gal) as well as an air filter.

➤ Controls

Fully-hydraulic control system allows precise control over main and auxiliary winch, luffing, swinging and traveling.

Control process is smooth.

➤ Hydraulic System

Hydraulic system consists of three parts: main circuit, control circuit and auxiliary circuit. Most hydraulic parts are imported.

The main pump is of variable displacement dual pump with constant power control, forming an open circuit with system pressure 30MPa (4354psi).

➤ Main and Auxiliary Hoisting Mechanism

The variable displacement hydraulic motor drives planetary gear speed reducer to control the hoisting and lowering of main and auxiliary winch devices, and the variable displacement hydraulic motor adjust displacement automatically according to the load to achieve the maximum winch speed.

Main hoisting devices	Drum diameter	560mm (22-1/16")
	Outermost cable speed	0~110m/min (0~361fpm)
	Diameter of steel wire	24mm (15/16")
	Length of steel wire for main hoisting gear	290m (951'5")
	Rated single-line pull	9,000kg (19,900lb)

Aux. hoisting devices	Drum diameter	560mm (22-1/16")
	Outermost cable speed	0~110m/min (0~361fpm)
	Diameter of steel wire	24mm (15/16")
	Length of steel wire for main hoisting gear	210m (689')
	Rated single-line pull	9,000kg (19,900lb)

➤ Luffing Gear

Luffing winch drum is equipped with ratchet pallet locking gear to ensure the safety of boom under non-operating conditions.



Luffing devices	Drum diameter	420mm (16-9/16")
	Outer cable speed	0~73m/min (0~239fpm)
	Diameter of Steel Wire	20mm (13/16")
	Length of steel wire for luffing winch	240m (787'5")
	Rated single-line pull	7,000kg (15,400lb)

➤ **Swing System**

Swing gear: it is driven by swing motor, allowing 360°revolution.

Swing brake: it is spring loaded; hydraulic pressure released and band type spring brake.

Swing lock: the locking gear is provided to protect the upperworks revolution from the impact during hoisting traveling or transportation.

Swing support: three-row-roller bearing in the type of 131.32.2000; the diameter of the roller is 32mm(1-1/4") and the diameter of the roller track is 2000mm(78-3/4").

Speed of swing: 0~1.9r/min (idling)

➤ **Swing Table**

Swing table is steel structured, and consists of left and right traveling table and main platform. The entire swing table is connected with chassis through turntable. Main hoisting mechanism, auxiliary hoisting mechanism, luffing mechanism, hydraulic system, power system and cab

are all mounted on the swing table. A-frame, operation equipment and counterweight are connected with different parts of the swing table respectively.

➤ **A-frame**

It is three-section telescopic design. A-frame stretches out during operation while retract back during transportation so as to reduce the transportation height.

➤ **Counterweight**

Standard counterweight is 42,000kg (92,600lb) except one 6,000kg(13,200lb) additional counterweight block. Each block of counterweight is 6,000kg(13,200lb) and there are 6 blocks, and one 6,000kg (13,200lb) counterweight tray in all. The additional counterweight is 3,000kg (6,600lb).The counterweight can achieve fully self-assembling and disassembling to facilitate transportation.

➤ **Classified Load Charts (optional)**

The additional counterweight is optional allocation. When the length of the boom is larger than 39m(128'), we can adopt additional counterweight. In order to prevent retroversion, the boom frame must be connected before installation. During disassembling, the procedures shall be opposite with that of assembling. The hoisting load shall be increased along with the adoption of counterweight. (See the load chart)

➤ **Cover**



Left cover: toolbox is below the first step in the front part. Handle for getting on is equipped in the front part, and the water tank inlet is on the top. Five access doors, which are equipped with silencing sponge, are provided in outside of the cover; the shutter is mounted inside.

Right cover: there is an access door with built-in silencing sponge.

➤ **Operator's Cab**

The novelty pattern sliding door of cab allows easy and safe opening and closing of door and window; the large window, together with head light and rearview mirror permit wider visual field; the perfect sealing and dust-proof and shock absorption can reduce the noise inside as well as improve air quality.

Seat: It is of standard configuration and adjustable.

Air conditioner: with heating and cooling functions.

Am/Fm radio: it is of standard configuration with clock.

Dry powder fire extinguisher: it is of standard configuration with a capacity of 6kg(13.2lb).

➤ **Control Operation**

Levers and traveling pedal are in the front lower part of manipulator position. The left traveling pedal (lever) drives left crawler belt and the right traveling pedal (lever) drives right one. Foot accelerator is at the right side of right traveling pedal.

The control handles of main and luffing winch are mounted on the right armrest box, so are the start switch of engine.

Auxiliary control handle, revolution control handle, lighter and control panel of air-conditioner are on the left rest box.

Switch panel of auxiliary control box is in the left front of manipulator, through which the corresponding functions can be achieved manually. Screen of load moment indicator and digital monitoring meter are beside the auxiliary control box to display relevant real-time information.

➤ **Alarm Display**

When error appears, all warning information including wind speed, oil temperature, water temperature, oil amount, oil pressure, working hours and engine speed will be displayed on the screen inside driver's cab. It will alarm under the condition that the A-frame was not completely hoisted under operation mode.

Lowerworks

➤ **Traveling**

Independent traveling gear is provided in each track frame. The hydraulic traveling motor drives planetary gear reducer and achieves independent traveling through driving wheel transmission.

➤ **Traveling Brake**

The normal state closed (i.e. it's in braking status when the control pedal valve is not



stepped.) it is built in reductor and compensated automatically without regulation. When the operating pedal is stepped down, the brake is released and the crane travels.

➤ **Crawler Pads**

The left and right track traveling device consists of 126 track shoes, width of which is 950mm(37-3/8"). Tension of track shoe can be adjusted through hydraulic jack. The perfect tensity can be achieved through adjustment of gasket position.

➤ **Chassis**

The power pin connected with the track frame is driven by the hydraulic cylinder, and easy to assemble and disassemble. The chassis is high strength welded frame structure.

➤ **Traveling Speed**

The variable displacement motor can realize double speed traveling with low speed of 0.68km/h(0.42mph) and high speed of 1.0km/h(0.68mph).

Operation Device

➤ **Main Boom**

The main chord pipe is made of high-strength steel. The boom frame is a space truss type structure welded by steel tube with constant section in the central part and variable cross section on both ends. The tip and base of the boom frame are strengthened with steel plate for easy transmission of load.

Standard configuration of booms: boom

base 7.5m(24'7"), boom tip 10.5m(34'5"), boom insert 3m×2(9'10"×2), boom insert 6m×2 (19'8"×2), and boom insert 9mA×3 (29'6"A×3) and boom insert 9mB×1 (29'6"B×1).

Length of boom is between the length of basic boom 18m (59'1") and maximum length 72m (236'3").

The boom frame adopts nonmetal pedal to reduce weight. The boom rope can be imported opening and closing steel curb wire.

➤ **Jib**

It is made of high strength main chord pipe. The boom support is a space truss structure. It is welded with steel pipe and is enforced by steel plates at tip and base so as to improve the performance of load transmission.

The basic jib length is 13m (42'8") (5m(16'5") jib tip, 3m (9'10") jib insert and 5m(16'5") jib base), and the jib insert of 6m×2 (19'8"×2) can be mounted on booms with following length: 39m (127'11"), 42m (137'10"), 45m (147'8"), 48m (157'6"), 51m (167'4"), 54m (177'2"), 57m (187'), 60m (196'10") and 63m (206'8"). Available jib lengths are 13m (42'8"), 19m (62'4") and 25m (82').

➤ **Hook Block**

Standard configuration

- 9 t (9.9USt) hook block
- 50 t (55USt) hook block
- 100 t (110USt) hook block



Optional parts:

15 t (16.5USt) hook block

35 t (38.6USt) hook block

Note: the above-mentioned equipments are the complete configurations. The detailed equipments shall be in accordance with the order.

Safety Device

➤ **Load Moment Indicator**

There is an independent security operating system controlled by computer in the load moment indicator. It can automatically detect the weight hoisted by the crane and the angle of the boom and indicate the rated load, actual load, operating radius and angle of the boom.

Composition: host machine, monitor, angle sensor and force sensor etc.

Function: instantaneously display the rated load, actual load, operation radius, angle and height of the boom under the current situation of the crane. Automatically detect the dynamic data of the angle over-limitation and load over-limitation and alarm immediately and stop the operation.

➤ **Anti-overwinding Device for Main and Auxiliary Hooks**

The limit switch and heavy punch fixed on the upper boom are used to prevent the hook from being lifted over high. When the hook is lifted to a certain height, the limit switch is activated so as to make the buzzer on the control board alarm by both

electronic and hydraulic control and the hook lifting operation stop automatically. On this occasion, the hook overwinding could be prevented.

➤ **Anti-overloosening Device for Main and Auxiliary Hooks**

It is composed of the motion trigger device fixed inside of the drum and proximity switch. It shall send signal when the steel wire was loosened close to the last 3 circles and the electronic controlling system shall automatically stop the hooks and alarm through buzzer and monitor.

➤ **Commutator for Assembling Mode/Operation Mode**

The anti-overwinding device, caging device of boom, A-frame alarming device, and moment limiter are all out of commission under the assembling mode so as to make it easier to install the crane. Under the operation mode, all the safety devices are operated.

➤ **A-frame Alarming Device**

Under operation mode, the system shall alarm through buzzer and monitor in case the A-frame was not lifted to the right position.

➤ **Caging Device for Boom**

When the elevation angle of the boom is over 78°, the buzzer shall alarm and the boom shall be stopped. Synchronously, the lifting operation of swing drum is out of commission and only lowering operation is allowed. This protection function shall be



controlled by both of the moment limiter and the two-stage control of travel switch.

When the angle of the boom is less than 30°, the buzzer shall alarm and the boom shall be stopped. Synchronously, the lowering operation of the swing drum is out of commission and only the lifting operation is allowed. This function shall be controlled by moment limiter.

➤ **Anti-retroversion Device for Boom**

The anti-retroversion rod is made in nested steel pipe and spring structure fixed on the top of the lower boom, which is equipped with the function of support through the spring pressure so as to prevent the main boom retroversion.

➤ **Swing Lock Device**

It is composed of swing braking electromagnetic valve and swing lock releasing electromagnetic valve. Only to open the swing locking electromagnetic valve first, the swing operation can be fulfilled.

➤ **Drum Lock Device**

Electronic controlled locking device is set all the winch drums, which means it is essential to release the pallet switch before the winding operation so as to prevent the misoperation caused by lever and to guarantee the safety when the winding is under non-operation mode.

➤ **Boom Angle Indicator**

Pendulum-type angle indicator mounted at

the side close to the driver's cab of the lower boom.

➤ **Hook Clamp**

Each kind of lifting hook is equipped with baffle used to prevent the hoisting wire rope from coming off.

➤ **Acousto-optic Alarm**

It can send acousto-optic alarm within 5 seconds after the engine starts and during swing and traveling. And the left and right shall flicker during swinging.

➤ **Gradienter**

Electronic gradienter can indicate the inclining angle of the upperworks on the monitor of the control system.

➤ **Relief Switch**

When the operator is not at seat or draws back the relief handle, the relief valve shall be closed and all the operations are out of commission so as to prevent misoperations.

➤ **Emergency Stopping Button**

When emergency occurs, press this button to cut off the electricity and stop all the operations.

➤ **Tricolor Load Alarming Light**

The load alarming light includes 3 colors, which can display the instantaneous load synchronously. Namely, the green color means the load rate is less than 90%, the yellow color means the load rate is between 90% to 100% and the red color means the load rate is over 100%, which is in overload situation.



➤ **Monitored Control System**

Camera: 2 PCS, respectively monitor the winch mechanism and the situation of the back portion for the complete appliance.

Monitor: the monitored images can be switched from one camera to the other through switches.

Whenever failure appears, the monitor shall show the information through related words and symbols.

➤ **Anti-lightening Stroke Protection Device**

It includes grounding devices and surge-protect device, which can prevent the damage of the electronic components and the hurt of the staff from lightening.

➤ **Optional Remote Monitoring System**

The functions of GPS satellite orientation, GPRS data transmission, inquiry of the operation of the equipments, statistic and remote failure diagnosis is available.

➤ **Illuminator**

Night lighting devices such as winch illuminator, dipped light in front of the driver's cab, angle adjustable high beam and head lamp in driver's cab shall be set so as to improve safety for construction during night.

➤ **Rearview Mirror**

The mirrors shall be respectively set at the right side of the driver's cab and the front handrail of the left cover.



Outline Dimensions

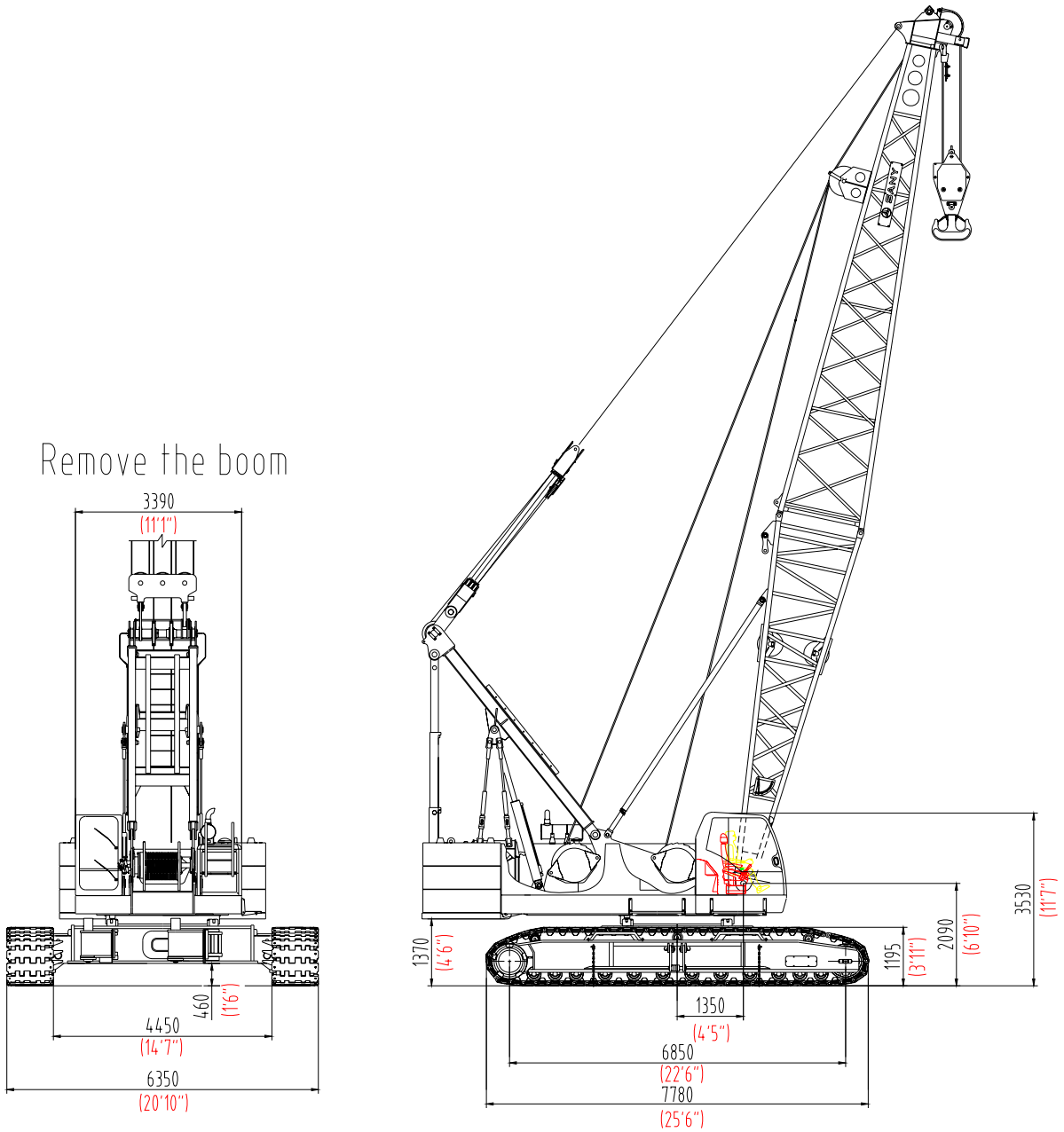



SCC1000C Hydraulic Crawler Crane

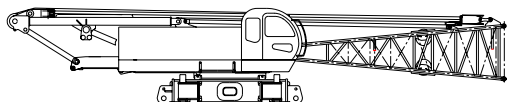

Main Body		×1
Length	16.1m	52'10"
Width	3.4m	11'2"
Height	3.1m	10'2"
Weight	45,000kg	99,200lb

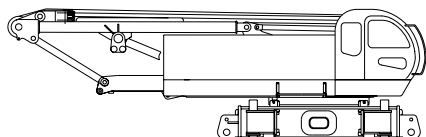

Main Body		×1
Length	9.7m	31'10"
Width	3.4m	11'2"
Height	3.1m	10'2"
Weight	43,000kg	92,600lb

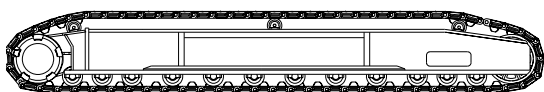

Track Assembly		×2
Length	7.9m	25'11"
Width	0.95m	3'1"
Height	1.2m	3'11"
Weight	16,500kg	36,400lb

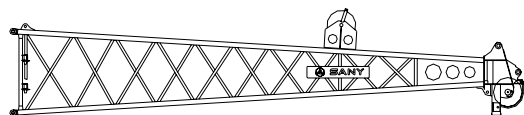

Boom tip		×1
Length	11m	36'1"
Width	1.9m	6'3"
Height	2.3m	7'7"
Weight	2,100kg	4,600lb

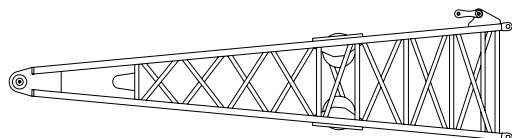

Boom base		×1
Length	7.8m	25'7"
Width	1.9m	6'3"
Height	2.1m	6'11"
Weight	2,500kg	5,500lb

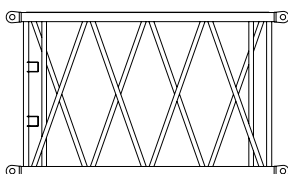

Boom insert 3m(9'10")		×2
Length	3.2m	10'6"
Width	1.9m	6'3"
Height	1.9m	6'3"
Weight	600kg	1,300lb

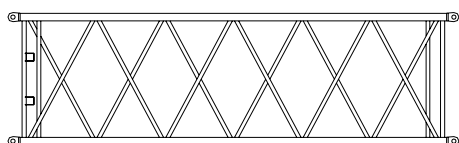

Boom insert 6m(19'8")		×2
Length	6.2m	20'4"
Width	1.9m	6'3"
Height	1.9m	6'3"
Weight	950kg	2,100lb

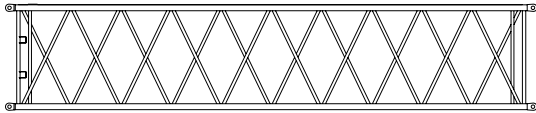

Boom insert 9mA(29'6'')		×3
Length	9.2m	30'2"
Width	1.9m	6'3"
Height	1.9m	6'3"
Weight	1,300kg	2,900lb

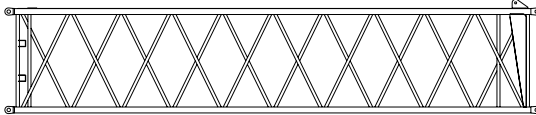

Boom insert 9mB(29'6'')		×1
Length	9.2m	30'2"
Width	1.9m	6'3"
Height	1.9m	6'3"
Weight	1,500kg	3,300lb

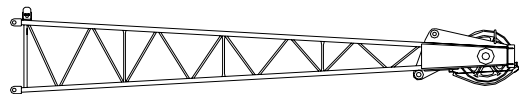

Jib tip		×1
Length	5.4m	17'9"
Width	1.1m	3'7"
Height	1.2m	3'11"
Weight	300kg	660lb

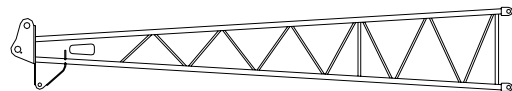

Jib base		×1
Length	5.2m	17'1"
Width	1.1m	3'7"
Height	0.83m	2'9"
Weight	200kg	440lb

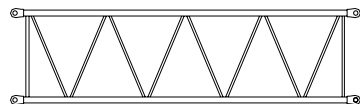

Jib insert 3m(9'10'')		×1
Length	3.1m	10'2"
Width	1.1m	3'7"
Height	0.83m	2'9"
Weight	100kg	220lb

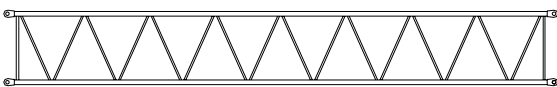

Jib insert 6m(19'8'')		×2
Length	6.1m	20'
Width	1.1m	3'7"
Height	0.83m	2'9"
Weight	200kg	440lb

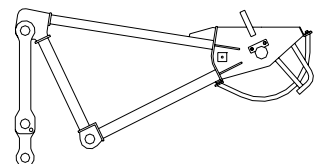

Boom extension		×1
Length	2.2m	7'3"
Width	1.1m	3'7"
Height	1.2m	3'11"
Weight	300kg	660lb

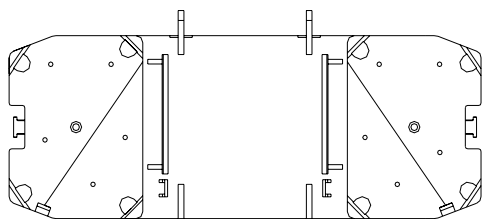

Counterweight tray	×1	
Length	4.2m	13'9"
Width	1.9m	6'3"
Height	0.5m	1'8"
Weight	660kg	1,500lb



Counterweight	×6	
Length	1.6m	5'3"
Width	1.2m	3'11"
Height	0.55m	1'10"
Weight	600kg	1,300lb



Additional	×3	
Length	0.93m	3'1"
Width	0.67m	2'2"
Height	1m	3'3"
Weight	3,100kg	6,800lb

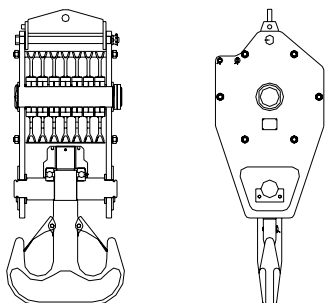

100t(110USt) hook block	×1	
Length	0.81m	2'8"
Width	0.74m	2'5"
Height	2.1m	6'11"
Weight	1,600kg	3,500lb

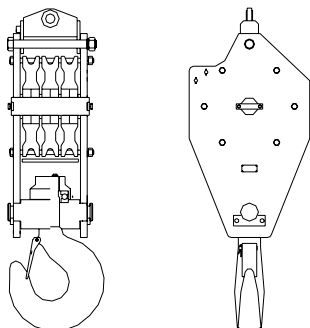

50t(55USt) hook block	×1	
Length	0.72m	2'4"
Width	0.41m	1'4"
Height	2m	6'7"
Weight	700kg	1,500lb

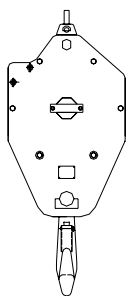
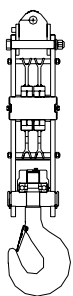

35t(39USt) hook block		×1
Length	0.72m	2'4"
Width	0.32m	1'1"
Height	1.8m	5'11"
Weight	600kg	1,300lb

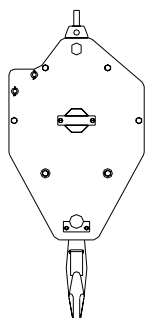
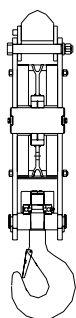

15t(16.5USt) hook block		×1
Length	0.72m	2'4"
Width	0.26m	10"
Height	1.7m	5'7"
Weight	500kg	1,100lb

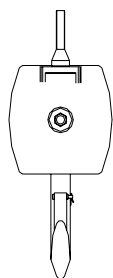
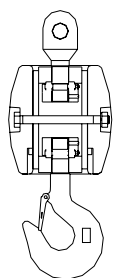

9t(9.9USt) hook block		×1
Length	0.36m	1'2"
Width	0.36m	1'2"
Height	0.95m	3'1"
Weight	300kg	660lb

Note:

- ①The transportation dimension of main parts is sketch map, which was not drawn according to the rate. The dimension in the sketch is design value excluding package.
- ②The weight is design value and there may be difference caused manufacture.

Self-assembly and Disassembly

This crane is equipped with functions including the self-assembly and disassembly of track traveling mechanism and self-assembly and disassembly of the counterweight. In the course of assembly, the track traveling mechanism should be assembled firstly and then the counterweight. In the course of disassembly, the counterweight should be disassembled firstly and then the track traveling mechanism. See the figure for detailed operation procedures.

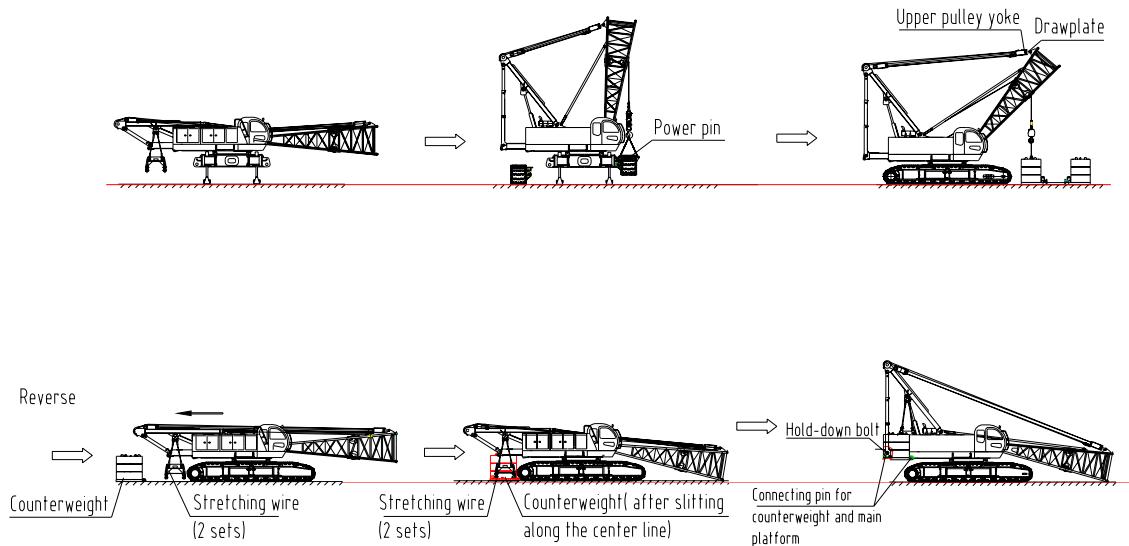

Schematic diagram of self-assembly of track frame and counterweight (perform reverse procedure for disassembly)

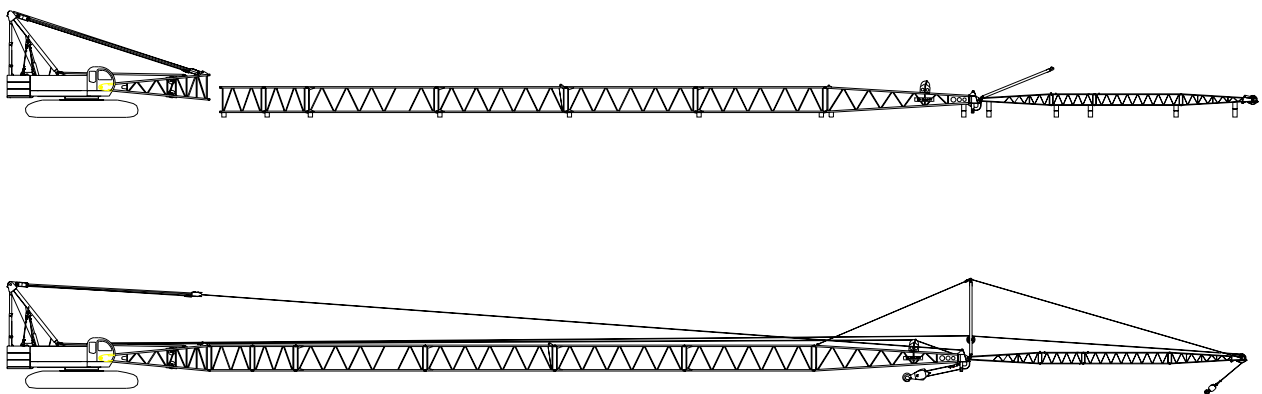

Schematic diagram of jib assembly



➤ **Main Boom Combinations**

Boom Length m (ft)	Boom inserts			
	3m (9'10")	6m (19'8")	9mA (29'6")A	9mB (29'6")B
18(59'1")	-	-	-	-
21(68'11")	1	-	-	-
24(78'9")	-	1	-	-
	2	-	-	-
27(88'7")	1	1	-	-
	-	-	1	-
30(98'5")	1	-	1	-
	-	2	-	-
33(108'3")	1	2	-	-
	-	1	1	-
36(118'1")	1	1	1	-
	-	-	2	-
	2	2	-	-
39(127'11")	2	1	1	-
	1	-	2	-
	-	2	1	-
42(137'10")	2	-	2	-
	-	1	2	-
45(147'8")	1	1	2	-
	-	-	3	-
	2	2	1	-
48(157'6")	1	-	3	-
	2	1	2	-
	-	2	2	-
51(167'4")	-	1	3	-
	2	-	3	-
54(177'2")	2	2	2	-
	1	1	3	-
57(187')	2	1	3	-
	-	2	3	-
60(196'10")	1	2	2	1
	2	-	3	1
63(206'8")	2	2	2	1
66(216'6")	2	1	3	1
69(226'5")	1	2	3	1
72(236'3")	2	2	3	1

Mai

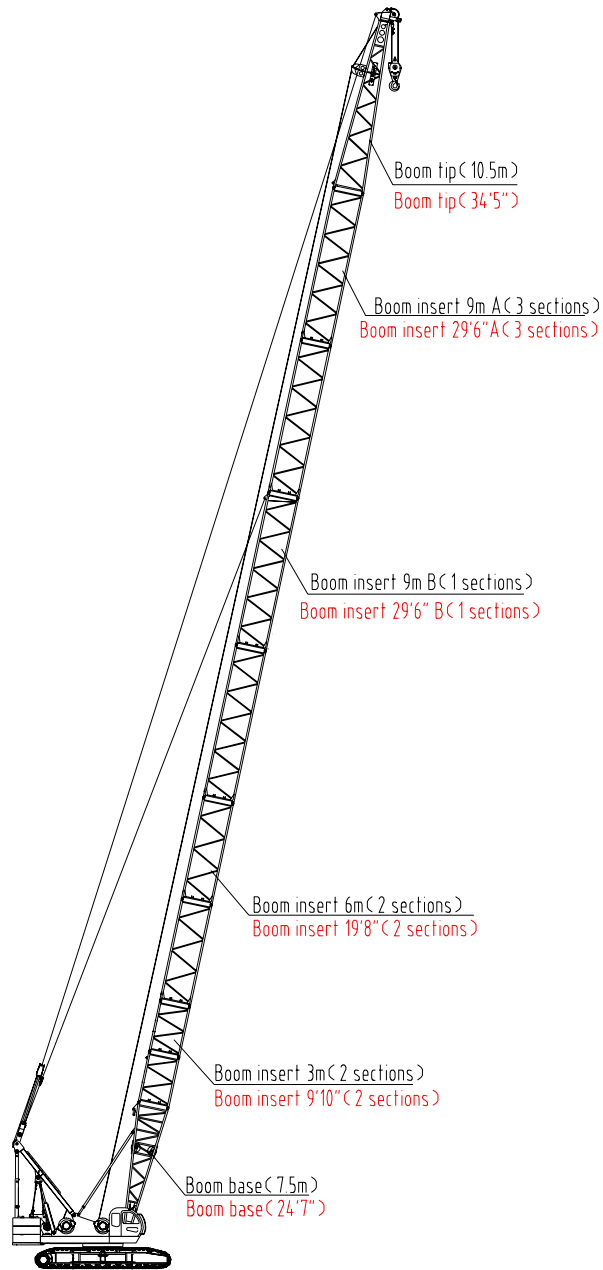

Boom Combinations: 18m~72m (59'1"~236'3")



◆ Main Boom Range Diagram

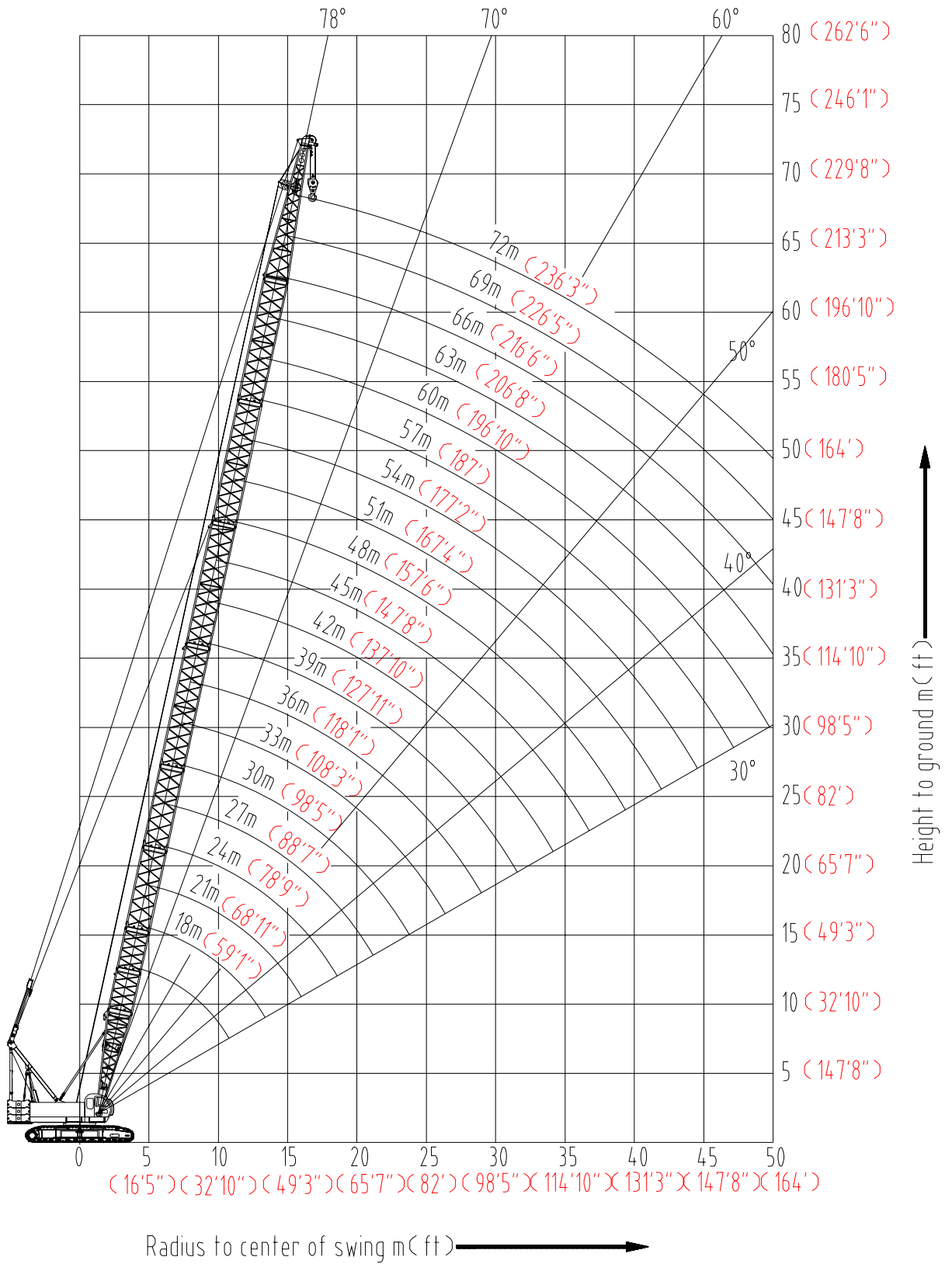



◆ Main Boom Load Charts

Boom Load Charts 1/4							
							kg(lb)×1000
Boom m(ft) Radius m(ft)	18 (59'1")	21 (68'11")	24 (78'9")	27 (88'7")	30 (98'5")	33 (108'3")	36 (118'1")
5.1 (16'9")	105.0 (231.5)						
5.5 (18'1")	100.0 (220.5)	90.9 (200.4)					
6.0 (19'8")	92.5 (203.9)	90.0 (198.4)	80.8 (178.1)	70.8 (156.1)			
7.0 (22'12")	79.5 (175.3)	78.7 (173.5)	77.5 (170.9)	70.0 (154.3)	60.5 (133.4)	57.3 (126.3)	
8.0 (26'3")	66.0 (145.5)	65.7 (144.8)	65.5 (144.4)	64.6 (142.4)	60.0 (132.3)	56.6 (124.8)	50.5 (111.3)
9.0 (29'6")	55.2 (121.7)	55.1 (121.5)	54.9 (121)	54.8 (120.8)	54.7 (120.6)	54.2 (119.5)	50.0 (110.2)
10.0 (32'10")	47.5 (104.7)	47.3 (104.3)	47.2 (104.1)	47.1 (103.8)	46.9 (103.4)	46.8 (103.2)	46.6 (102.7)
12.0 (39'4")	36.9 (81.3)	36.7 (80.9)	36.5 (80.5)	36.4 (80.2)	36.3 (80)	36.1 (79.6)	36.0 (79.4)
14.0 (45'11")	30.1 (66.4)	29.8 (65.7)	29.6 (65.3)	29.5 (65)	29.3 (64.6)	30.2 (66.6)	29.1 (64.2)
16.0 (52'6")	25.2 (55.6)	25.0 (55.1)	24.8 (54.7)	24.7 (54.5)	24.5 (54)	24.3 (53.6)	24.2 (53.4)
18.0 (59'1")	21.7 (47.8)	21.5 (47.4)	21.2 (46.7)	21.1 (46.5)	20.9 (46.1)	20.8 (45.9)	20.7 (45.6)
20.0 (65'7")		19.4 (42.8)	18.6 (41)	18.4 (40.6)	18.2 (40.1)	18.0 (39.7)	17.9 (39.5)
22.0 (72'2")		17.1 (37.7)	17.0 (37.5)	16.3 (35.9)	16.1 (35.5)	15.9 (35.1)	15.8 (34.8)
24.0 (78'9")			14.7 (32.4)	14.5 (32)	14.2 (31.3)	14.1 (31.1)	14.0 (30.9)
26.0 (85'4")				12.8 (28.2)	12.7 (28)	12.6 (27.8)	12.5 (27.6)
28.0 (91'10")					11.1 (24.5)	11.4 (25.1)	11.3 (24.9)
30.0 (98'5")						10.5 (23.1)	10.3 (22.7)
32.0 (104'12")						9.7 (21.4)	9.4 (20.7)
34.0 (111'7")							8.6 (19)
Counterweight kg(lb)×1000	42 (92.6)	42 (92.6)	42 (92.6)	42 (92.6)	42 (92.6)	42 (92.6)	42 (92.6)

Note: 1. the actual hoisting capacity is the value that rated hoisting capacity in the table deducts the weight of hook block and other lifting tools.

2. The rated loads in the table represent the values when slowly and smoothly hoisting a weight on a horizontal and hardy soil surface under non-traveling hoisting working state.

3. All values in the load table apply to 360° rotation.

4. The rated loads in the table were calculated under the condition that the wind speed was 9.8m/s (22 mph) and according to 75% of the tilting load.



Boom Load Charts 2/4									kg(lb)×1000
Boom m(ft) Radius m(ft)	39 (127'11")		42 (137'10")		45 (147'8")		48 (157'6")		
8.0 (26'3")	46.6 (102.7)	<i>49.4</i> (108.9)							
9.0 (29'6")	46.2 (101.9)	<i>49.0</i> (108)	44.2 (97.4)	<i>46.9</i> (103.4)	41.2 (90.8)	<i>43.7</i> (96.3)			
10.0 (32'10")	44.7 (98.5)	<i>47.4</i> (104.5)	42.4 (93.5)	<i>44.9</i> (99)	40.4 (89.1)	<i>42.8</i> (94.4)	35.6 (78.5)	<i>37.7</i> (83.1)	
12.0 (39'4")	35.9 (79.1)	<i>38.1</i> (84)	35.8 (78.9)	<i>37.9</i> (83.6)	35.7 (78.7)	<i>37.8</i> (83.3)	33.7 (74.3)	<i>35.7</i> (78.7)	
14.0 (45'11")	28.9 (63.7)	<i>30.6</i> (67.5)	28.8 (63.5)	<i>30.5</i> (67.2)	28.7 (63.3)	<i>30.4</i> (67)	28.6 (63.1)	<i>30.3</i> (66.8)	
16.0 (52'6")	24.0 (52.9)	<i>25.4</i> (56)	23.9 (52.7)	<i>25.3</i> (55.8)	23.8 (52.5)	<i>25.2</i> (55.6)	23.7 (52.2)	<i>25.1</i> (55.3)	
18.0 (59'1")	20.5 (45.2)	<i>21.7</i> (47.8)	20.4 (45)	<i>21.6</i> (47.6)	20.2 (44.5)	<i>21.4</i> (47.2)	20.1 (44.3)	<i>21.3</i> (47)	
20.0 (65'7")	17.7 (39)	<i>18.8</i> (41.4)	17.6 (38.8)	<i>18.7</i> (41.2)	17.5 (38.6)	<i>18.6</i> (41)	17.4 (38.4)	<i>18.4</i> (40.6)	
22.0 (72'2")	15.6 (34.4)	<i>16.5</i> (36.4)	15.5 (34.2)	<i>16.4</i> (36.2)	15.3 (33.7)	<i>16.2</i> (35.7)	15.2 (33.5)	<i>16.1</i> (35.5)	
24.0 (78'9")	13.7 (30.2)	<i>14.5</i> (32)	13.6 (30)	<i>14.4</i> (31.7)	13.5 (29.8)	<i>14.3</i> (31.5)	13.3 (29.3)	<i>14.1</i> (31.1)	
26.0 (85'4")	12.3 (27.1)	<i>13.0</i> (28.7)	12.2 (26.9)	<i>12.9</i> (28.4)	12.0 (26.5)	<i>12.7</i> (28)	11.9 (26.2)	<i>12.6</i> (27.8)	
28.0 (91'10")	11.0 (24.3)	<i>11.7</i> (25.8)	10.9 (24)	<i>11.6</i> (25.6)	10.8 (23.8)	<i>11.4</i> (25.1)	10.6 (23.4)	<i>11.2</i> (24.7)	
30.0 (98'5")	10.0 (22)	<i>10.6</i> (23.4)	9.9 (21.8)	<i>10.5</i> (23.1)	9.7 (21.4)	<i>10.3</i> (22.7)	9.6 (21.2)	<i>10.2</i> (22.5)	
32.0 (104'12")	9.1 (20.1)	<i>9.6</i> (21.2)	9.0 (19.8)	<i>9.5</i> (20.9)	8.8 (19.4)	<i>9.3</i> (20.5)	8.7 (19.2)	<i>9.2</i> (20.3)	
34.0 (111'7")	8.4 (18.5)	<i>8.9</i> (19.6)	8.2 (18.1)	<i>8.7</i> (19.2)	8.1 (17.9)	<i>8.6</i> (19)	7.9 (17.4)	<i>8.4</i> (18.5)	
36.0 (118'1")	7.4 (16.3)	<i>7.8</i> (17.2)	7.3 (16.1)	<i>7.7</i> (17)	7.2 (15.9)	<i>7.6</i> (16.8)	7.1 (15.7)	<i>7.5</i> (16.5)	
38.0 (124'8")			6.8 (15)	<i>7.2</i> (15.9)	6.7 (14.8)	<i>7.1</i> (15.7)	6.5 (14.3)	<i>6.9</i> (15.2)	
40.0 (131'3")			6.5 (14.3)	<i>6.9</i> (15.2)	6.2 (13.7)	<i>6.6</i> (14.6)	6.1 (13.4)	<i>6.5</i> (14.3)	
42.0 (137'10")					5.6 (12.3)	<i>5.9</i> (13)	5.5 (12.1)	<i>5.8</i> (12.8)	
44.0 (144'4")							4.7 (10.4)	<i>5.0</i> (11)	
Counterweight kg(lb)×1000	42 (92.6)	42+3 (92.6+6.6)	42 (92.6)	42+3 (92.6+6.6)	42 (92.6)	42+3 (92.6+6.6)	42 (92.6)	42+3 (92.6+6.6)	

Note: 1. the actual hoisting capacity is the value that rated hoisting capacity in the table deducts the weight of hook block and other lifting tools.

2. The italic values in grey filling table means the operating condition under which standard counterweight and additional counterweight are included.

3. The rated loads in the table represent the values when slowly and smoothly hoisting a weight on a horizontal and hardy soil surface under non-traveling hoisting working state.

4. All values in the load table apply to 360° rotation.

5. The rated loads in the table were calculated under the condition that the wind speed was 9.8m/s (22 mph) and according to 75% of the tilting load.

Note: To prevent retroversion, it is essential to connect a 39m (127'11") long boom frame and then install the additional counterweight.



Boom Load Charts 3/4								kg(lb)×1000	
Boom m(ft) Radius m(ft)	51 (167'4")		54 (177'2")		57 (187'0")		60 (196'10")		
10.0 (32'10")	32.8 (72.3)	<i>34.8</i> (76.7)	28.7 (63.3)	<i>30.4</i> (67)	26.3 (58)	<i>27.9</i> (61.5)			
12.0 (39'4")	30.3 (66.8)	<i>32.1</i> (70.8)	28.2 (62.2)	<i>29.9</i> (65.9)	26.2 (57.8)	<i>27.8</i> (61.3)	24.5 (54)	26.0 (57.3)	
14.0 (45'11")	28.5 (62.8)	<i>30.2</i> (66.6)	26.9 (59.3)	<i>28.5</i> (62.8)	25.3 (55.8)	<i>26.8</i> (59.1)	23.7 (52.2)	25.1 (55.3)	
16.0 (52'6")	23.5 (51.8)	<i>24.9</i> (54.9)	23.4 (51.6)	<i>24.8</i> (54.7)	23.2 (51.1)	<i>24.6</i> (54.2)	22.1 (48.7)	23.4 (51.6)	
18.0 (59'1")	20.0 (44.1)	<i>21.2</i> (46.7)	19.8 (43.7)	<i>21.0</i> (46.3)	19.6 (43.2)	<i>20.8</i> (45.9)	19.5 (43)	20.7 (45.6)	
20.0 (65'7")	17.2 (37.9)	<i>18.2</i> (40.1)	17.1 (37.7)	<i>18.1</i> (39.9)	16.9 (37.3)	<i>17.9</i> (39.5)	16.8 (37)	17.8 (39.2)	
22.0 (72'2")	14.9 (32.8)	<i>15.8</i> (34.8)	14.8 (32.6)	<i>15.7</i> (34.6)	14.6 (32.2)	<i>15.5</i> (34.2)	14.5 (32)	15.4 (34)	
24.0 (78'9")	13.2 (29.1)	<i>14.0</i> (30.9)	13.0 (28.7)	<i>13.8</i> (30.4)	12.8 (28.2)	<i>13.6</i> (30)	12.7 (28)	13.5 (29.8)	
26.0 (85'4")	11.7 (25.8)	<i>12.4</i> (27.3)	11.5 (25.4)	<i>12.2</i> (26.9)	11.3 (24.9)	<i>12.0</i> (26.5)	11.2 (24.7)	11.9 (26.2)	
28.0 (91'10")	10.5 (23.1)	<i>11.1</i> (24.5)	10.3 (22.7)	<i>10.9</i> (24)	10.1 (22.3)	<i>10.7</i> (23.6)	10.0 (22)	10.6 (23.4)	
30.0 (98'5")	9.4 (20.7)	<i>10.0</i> (22)	9.3 (20.5)	<i>9.9</i> (21.8)	9.0 (19.8)	<i>9.5</i> (20.9)	8.9 (19.6)	9.4 (20.7)	
32.0 (104'12")	8.5 (18.7)	<i>9.0</i> (19.8)	8.4 (18.5)	<i>8.9</i> (19.6)	8.1 (17.9)	<i>8.6</i> (19)	8.0 (17.6)	8.5 (18.7)	
34.0 (111'7")	7.7 (17)	<i>8.2</i> (18.1)	7.6 (16.8)	<i>8.1</i> (17.9)	7.3 (16.1)	<i>7.7</i> (17)	7.2 (15.9)	7.6 (16.8)	
36.0 (118'1")	7.0 (15.4)	<i>7.4</i> (16.3)	6.9 (15.2)	<i>7.3</i> (16.1)	6.6 (14.6)	<i>7.0</i> (15.4)	6.5 (14.3)	6.9 (15.2)	
38.0 (124'8")	6.4 (14.1)	<i>6.8</i> (15)	6.3 (13.9)	<i>6.7</i> (14.8)	6.0 (13.2)	<i>6.4</i> (14.1)	6.0 (13.2)	6.4 (14.1)	
40.0 (131'3")	5.9 (13)	<i>6.3</i> (13.9)	5.7 (12.6)	<i>6.0</i> (13.2)	5.5 (12.1)	<i>5.8</i> (12.8)	5.4 (11.9)	5.7 (12.6)	
42.0 (137'10")	5.4 (11.9)	<i>5.7</i> (12.6)	5.2 (11.5)	<i>5.5</i> (12.1)	4.9 (10.8)	<i>5.2</i> (11.5)	4.8 (10.6)	5.1 (11.2)	
44.0 (144'4")	4.6 (10.1)	<i>4.9</i> (10.8)	4.5 (9.9)	<i>4.8</i> (10.6)	4.4 (9.7)	<i>4.7</i> (10.4)	4.3 (9.5)	4.6 (10.1)	
46.0 (150'11")	4.4 (9.7)	<i>4.7</i> (10.4)	4.3 (9.5)	<i>4.6</i> (10.1)	4.0 (8.8)	<i>4.2</i> (9.3)	3.8 (8.4)	4.0 (8.8)	
48.0 (157'6")	3.9 (8.6)	<i>4.1</i> (9)	3.6 (7.9)	<i>3.8</i> (8.4)	3.5 (7.7)	<i>3.7</i> (8.2)	3.4 (7.5)	3.6 (7.9)	
50.0 (164'0")			3.3 (7.3)	<i>3.5</i> (7.7)	3.1 (6.8)	<i>3.3</i> (7.3)	3.0 (6.6)	3.2 (7.1)	
52.0 (170'7")					2.7 (6)	<i>2.9</i> (6.4)	2.6 (5.7)	2.8 (6.2)	
Counterweight kg(lb)×1000	42 (92.6)	<i>42+3</i> (92.6+6.6)	42 (92.6)	<i>42+3</i> (92.6+6.6)	42 (92.6)	<i>42+3</i> (92.6+6.6)	42 (92.6)	<i>42+3</i> (92.6+6.6)	

Note: 1. the actual hoisting capacity is the value that rated hoisting capacity in the table deducts the weight of hook block and other lifting tools.

2. The italic values in grey filling table means the operating condition under which standard counterweight and additional counterweight are included.

3. The rated loads in the table represent the values when slowly and smoothly hoisting a weight on a horizontal and hardy soil surface under non-traveling hoisting working state.

4. All values in the load table apply to 360° rotation.

5. The rated loads in the table were calculated under the condition that the wind speed was 9.8m/s (22 mph) and according to 75% of the tilting load.

Note: To prevent retroversion, it is essential to connect a 39m (127'11") long boom frame and then install the additional counterweight.



Boom Load Charts 4/4									kg(lb)×1000
Boom m(ft) Radius m(ft)	63 (206'8")		66 (216'6")		69 (226'5")		72 (236'3")		
12.0 (39'4")	22.9 (50.5)	24.3 (53.6)	19.4 (42.8)	20.6 (45.4)					
14.0 (45'11")	21.8 (48.1)	23.1 (50.9)	19.2 (42.3)	20.4 (45)	17.8 (39.2)	18.9 (41.7)	16.0 (35.3)	17.0 (37.5)	
16.0 (52'6")	20.2 (44.5)	21.4 (47.2)	18.3 (40.3)	19.4 (42.8)	17.0 (37.5)	18.0 (39.7)	15.4 (34)	16.3 (35.9)	
18.0 (59'1")	19.4 (42.8)	20.6 (45.4)	17.5 (38.6)	18.6 (41)	16.2 (35.7)	17.2 (37.9)	14.6 (32.2)	15.5 (34.2)	
20.0 (65'7")	16.7 (36.8)	17.7 (39)	16.5 (36.4)	17.5 (38.6)	15.5 (34.2)	16.4 (36.2)	13.9 (30.6)	14.7 (32.4)	
22.0 (72'2")	14.4 (31.7)	15.3 (33.7)	14.2 (31.3)	15.1 (33.3)	14.0 (30.9)	14.8 (32.6)	13.0 (28.7)	13.8 (30.4)	
24.0 (78'9")	12.6 (27.8)	13.4 (29.5)	12.4 (27.3)	13.1 (28.9)	12.2 (26.9)	12.9 (28.4)	12.0 (26.5)	12.7 (28)	
26.0 (85'4")	11.1 (24.5)	11.8 (26)	10.9 (24)	11.6 (25.6)	10.7 (23.6)	11.3 (24.9)	10.5 (23.1)	11.1 (24.5)	
28.0 (91'10")	9.9 (21.8)	10.5 (23.1)	9.7 (21.4)	10.3 (22.7)	9.5 (20.9)	10.1 (22.3)	9.3 (20.5)	9.9 (21.8)	
30.0 (98'5")	8.8 (19.4)	9.3 (20.5)	8.6 (19)	9.1 (20.1)	8.4 (18.5)	8.9 (19.6)	8.2 (18.1)	8.7 (19.2)	
32.0 (104'12")	7.9 (17.4)	8.4 (18.5)	7.7 (17)	8.2 (18.1)	7.5 (16.5)	8.0 (17.6)	7.3 (16.1)	7.7 (17)	
34.0 (111'7")	7.1 (15.7)	7.5 (16.5)	6.9 (15.2)	7.3 (16.1)	6.7 (14.8)	7.1 (15.7)	6.5 (14.3)	6.9 (15.2)	
36.0 (118'1")	6.4 (14.1)	6.8 (15)	6.2 (13.7)	6.6 (14.6)	6.0 (13.2)	6.4 (14.1)	5.8 (12.8)	6.1 (13.4)	
38.0 (124'8")	5.8 (12.8)	6.1 (13.4)	5.6 (12.3)	5.9 (13)	5.4 (11.9)	5.7 (12.6)	5.1 (11.2)	5.4 (11.9)	
40.0 (131'3")	5.2 (11.5)	5.5 (12.1)	4.9 (10.8)	5.2 (11.5)	4.6 (10.1)	4.9 (10.8)	4.3 (9.5)	4.6 (10.1)	
42.0 (137'10")	4.6 (10.1)	4.9 (10.8)	4.3 (9.5)	4.6 (10.1)	4.1 (9)	4.3 (9.5)	3.8 (8.4)	4.0 (8.8)	
44.0 (144'4")	4.1 (9)	4.3 (9.5)	3.8 (8.4)	4.0 (8.8)	3.5 (7.7)	3.7 (8.2)	3.2 (7.1)	3.4 (7.5)	
46.0 (150'11")	3.6 (7.9)	3.8 (8.4)	3.3 (7.3)	3.5 (7.7)	3.1 (6.8)	3.3 (7.3)	2.8 (6.2)	3.0 (6.6)	
48.0 (157'6")	3.2 (7.1)	3.4 (7.5)	2.9 (6.4)	3.1 (6.8)	2.6 (5.7)	2.8 (6.2)	2.3 (5.1)	2.4 (5.3)	
50.0 (164'0")	2.8 (6.2)	3.0 (6.6)	2.5 (5.5)	2.7 (6)	2.3 (5.1)	2.4 (5.3)	2.0 (4.4)	2.1 (4.6)	
52.0 (170'7")	2.4 (5.3)	2.5 (5.5)	2.1 (4.6)	2.2 (4.9)	2.0 (4.4)	2.1 (4.6)	1.8 (4)	1.9 (4.2)	
Counterweight kg(lb)×1000	42 (92.6)	42+3 (92.6+6.6)	42 (92.6)	42+3 (92.6+6.6)	42 (92.6)	42+3 (92.6+6.6)	42 (92.6)	42+3 (92.6+6.6)	

Note: 1. the actual hoisting capacity is the value that rated hoisting capacity in the table deducts the weight of hook block and other lifting tools.

2. The italic values in grey filling table means the operating condition under which standard counterweight and additional counterweight are included.

3. The rated loads in the table represent the values when slowly and smoothly hoisting a weight on a horizontal and hardy soil surface under non-traveling hoisting working state.

4. All values in the load table apply to 360° rotation.

5. The rated loads in the table were calculated under the condition that the wind speed was 9.8m/s (22 mph) and according to 75% of the tilting load.

Note: To prevent retroversion, it is essential to connect a 39m (127'11") long boom frame and then install the additional counterweight.

◆ Fixed Jib Combinations

Jib Length m(ft)	Jib inserts		Main boom Length m(ft)	Angle between Main Boom and Jib
	3 m (9'10")	6 m (19'8")		
13 (42'8")	1	-	39~63 (127'11"~206'8")	15°, 30°
19 (62'4")	1	1	39~63 (127'11"~206'8")	15°, 30°
25 (82')	1	2	39~60 (127'11"~196'10")	15°, 30°

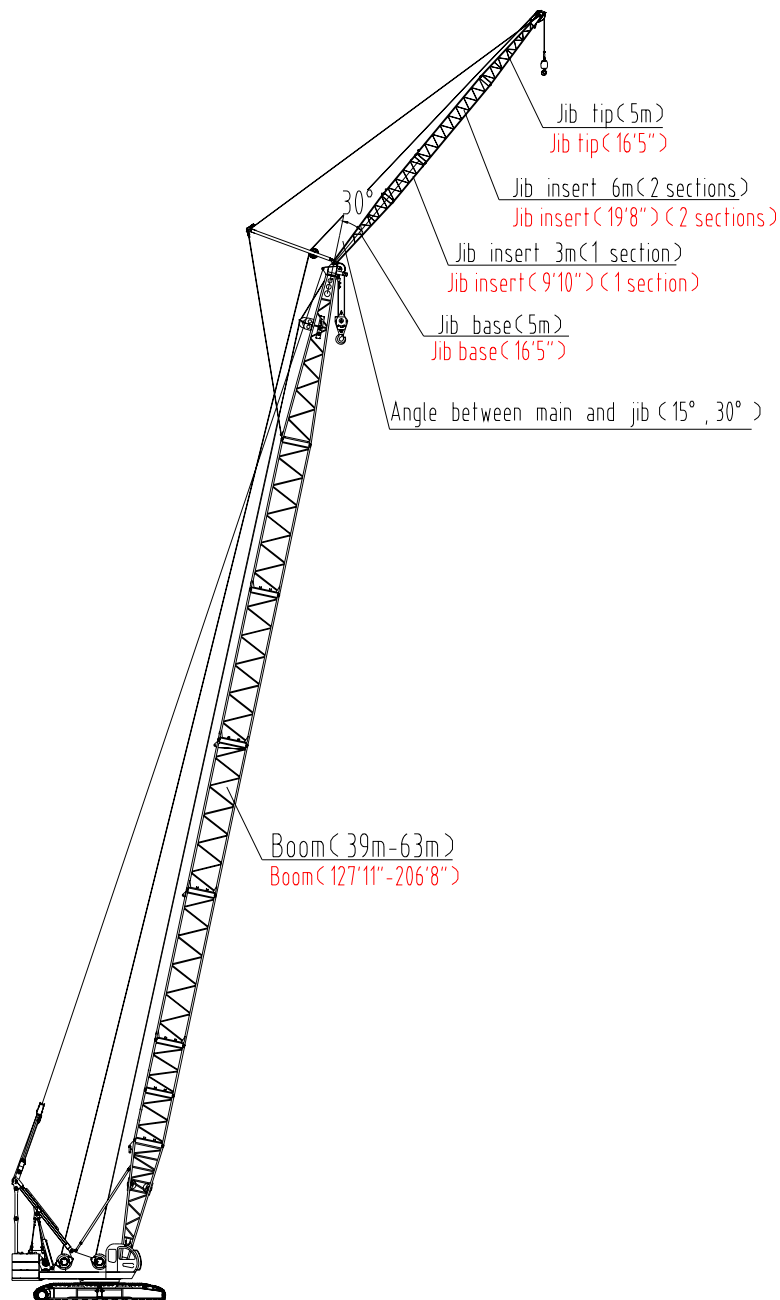



◆ Fixed Jib Range Diagram

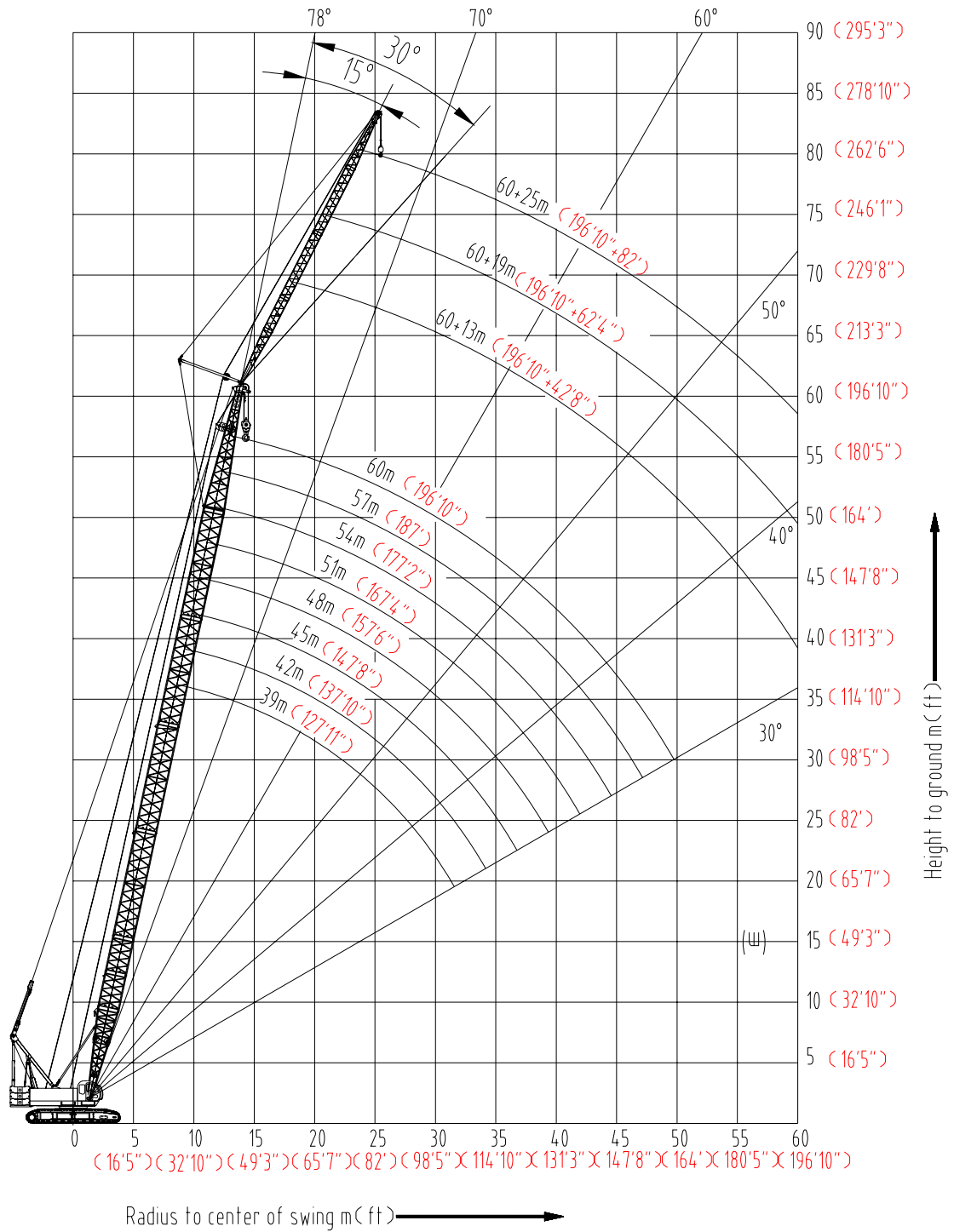



◆ Fixed Jib Load Charts

Fixed Jib Load Charts 1/10									kg(lb)×1000
Main Boom Length m(ft)	39m (127'11")								
Fixed Jib Length m(ft)	13m (42'8")				19m (62'4")				
Jib Angle	15°		30°		15°		30°		
Radius m(ft)	15°		30°		15°		30°		
14m (45'11")	14.3/11.0 (46'11"/24.3)	14.3/11.5 (46'11"/25.4)							
16m (52'6")	11.0 (24.3)	11.5 (25.4)	17.2/8.0 (56'5"/17.6)	17.2/8.4 (56'5"/18.5)	17.2/7.2 (56'5"/15.9)	17.2/7.5 (56'5"/16.5)			
18m (59'1")	11.0 (24.3)	11.5 (25.4)	8.0 (17.6)	8.4 (18.5)	7.2 (15.9)	7.5 (16.5)			
20m (65'7")	11.0 (24.3)	11.5 (25.4)	8.0 (17.6)	8.4 (18.5)	7.2 (15.9)	7.5 (16.5)	21.1/5.7 (69'3"/12.6)	21.1/6.0 (69'3"/13.2)	
22m (72'2")	11.0 (24.3)	11.5 (25.4)	8.0 (17.6)	8.4 (18.5)	7.2 (15.9)	7.5 (16.5)	5.7 (12.6)	6.0 (13.2)	
24m (78'9")	11.0 (24.3)	11.5 (25.4)	8.0 (17.6)	8.4 (18.5)	7.2 (15.9)	7.5 (16.5)	5.7 (12.6)	6.0 (13.2)	
26m (85'4")	11.0 (24.3)	11.5 (25.4)	8.0 (17.6)	8.4 (18.5)	7.2 (15.9)	7.5 (16.5)	5.7 (12.6)	6.0 (13.2)	
28m (91'10")	29.0/11.0 (95'2"/24.3)	29.0/11.5 (95'2"/25.4)	8.0 (17.6)	8.4 (18.5)	7.2 (15.9)	7.5 (16.5)	5.7 (12.6)	6.0 (13.2)	
30m (98'5")	10.6 (23.4)	11.1 (24.5)	8.0 (17.6)	8.4 (18.5)	7.2 (15.9)	7.5 (16.5)	5.7 (12.6)	6.0 (13.2)	
32m (104'12")	10.0 (22)	10.5 (23.1)	8.0 (17.6)	8.4 (18.5)	7.2 (15.9)	7.5 (16.5)	5.7 (12.6)	6.0 (13.2)	
34m (111'7")	9.4 (20.7)	9.8 (21.6)	8.0 (17.6)	8.4 (18.5)	7.2 (15.9)	7.5 (16.5)	5.7 (12.6)	6.0 (13.2)	
36m (118'1")	34.7/9.4 (113'10"/20.7)	34.7/9.8 (113'10"/21.6)	34.7/8.0 (113'10"/17.6)	34.7/8.4 (113'10"/18.5)	34.7/7.2 (113'10"/15.9)	34.7/7.5 (113'10"/16.5)	34.7/5.7 (113'10"/12.6)	34.7/6.0 (113'10"/13.2)	
Counterweight kg(lb)×1000	42 (92.6)	(42+3) (92.6+6.6)	42 (92.6)	(42+3) (92.6+6.6)	42 (92.6)	(42+3) (92.6+6.6)	42 (92.6)	(42+3) (92.6+6.6)	

Main Boom Length m(ft)	39m (127'11")				42m (137'10")			
Fixed Jib Length m(ft)	25m (82'0")				13m (42'8")			
Jib Angle	15°		30°		15°		30°	
Radius m(ft)	15°		30°		15°		30°	
14m (45'11")					14.9/11.0 (48'11"/24.3)	14.9/11.5 (48'11"/25.4)		
16m (52'6")					11.0 (24.3)	11.5 (25.4)		
18m (59'1")	19.5/4.6 (63'12"/10.1)	19.5/4.8 (63'12"/10.6)			11.0 (24.3)	11.5 (25.4)	18.2/8.0 (59'9"/17.6)	18.2/8.4 (59'9"/18.5)
20m (65'7")	4.6 (10.1)	4.8 (10.6)			11.0 (24.3)	11.5 (25.4)	8.0 (17.6)	8.4 (18.5)
22m (72'2")	4.6 (10.1)	4.8 (10.6)			11.0 (24.3)	11.5 (25.4)	8.0 (17.6)	8.4 (18.5)
24m (78'9")	4.6 (10.1)	4.8 (10.6)	25.1/3.9 (82'4"/8.6)	25.1/4.1 (82'4"/9)	11.0 (24.3)	11.5 (25.4)	8.0 (17.6)	8.4 (18.5)
26m (85'4")	4.6 (10.1)	4.8 (10.6)	3.9 (8.6)	4.1 (9)	11.0 (24.3)	11.5 (25.4)	8.0 (17.6)	8.4 (18.5)
28m (91'10")	4.6 (10.1)	4.8 (10.6)	3.9 (8.6)	4.1 (9)	11.0 (24.3)	11.5 (25.4)	8.0 (17.6)	8.4 (18.5)
30m (98'5")	4.6 (10.1)	4.8 (10.6)	3.9 (8.6)	4.1 (9)	11.0 (24.3)	11.5 (25.4)	8.0 (17.6)	8.4 (18.5)
32m (104'12")	4.6 (10.1)	4.8 (10.6)	3.9 (8.6)	4.1 (9)	10.3 (22.7)	10.8 (23.8)	8.0 (17.6)	8.4 (18.5)
34m (111'7")	4.6 (10.1)	4.8 (10.6)	3.9 (8.6)	4.1 (9)	9.3 (20.5)	9.7 (21.4)	8.0 (17.6)	8.4 (18.5)
36m (118'1")	34.7/4.6 (113'10"/10.1)	34.7/4.8 (113'10"/10.6)	34.7/3.9 (113'10"/8.6)	34.7/4.1 (113'10"/9)	8.4 (18.5)	8.8 (19.4)	8.0 (17.6)	8.4 (18.5)
38m (124'8")					37.1/8.2 (121'9"/18.1)	37.1/8.6 (121'9"/19)	37.1/8.0 (121'9"/17.6)	37.1/8.4 (121'9"/18.5)
Counterweight kg(lb)×1000	42 (92.6)	(42+3) (92.6+6.6)	42 (92.6)	(42+3) (92.6+6.6)	42 (92.6)	(42+3) (92.6+6.6)	42 (92.6)	(42+3) (92.6+6.6)

Note: 1. The actual hoisting weight is the value that rated load in the table deducts the weight of hook



block and other lifting tools.

2. Rated hoisting load in this table is the weight lifted from level and hard ground.

3. The italic values in grey filling table means the operating condition under which standard counterweight and additional counterweight are included.



Fixed Jib Load Charts 2/10									kg(lb)×1000
Main Boom Length m(ft)	42m (137'10")								
Fixed Jib Length m(ft)	19m (62'4")				25m (82'0")				
Jib Angle	15°		30°		15°		30°		
Radius m(ft)									
16m (52'6")	17.6/7.2 (57'9"/15.9)	17.6/7.5 (57'9"/16.5)							
18m (59'1")	7.2 (15.9)	7.5 (16.5)							
20m (65'7")	7.2 (15.9)	7.5 (16.5)	21.5/5.7 (70'6"/12.6)	21.5/6.0 (70'6"/13.2)	20.1/4.6 (65'11"/10.1)	20.1/4.8 (65'11"/10.6)			
22m (72'2")	7.2 (15.9)	7.5 (16.5)	5.7 (12.6)	6.0 (13.2)	4.6 (10.1)	4.8 (10.6)			
24m (78'9")	7.2 (15.9)	7.5 (16.5)	5.7 (12.6)	6.0 (13.2)	4.6 (10.1)	4.8 (10.6)	25.4/3.9 (83'4"/8.6)	25.4/4.1 (83'4"/9)	
26m (85'4")	7.2 (15.9)	7.5 (16.5)	5.7 (12.6)	6.0 (13.2)	4.6 (10.1)	4.8 (10.6)	3.9 (8.6)	4.1 (9)	
28m (91'10")	7.2 (15.9)	7.5 (16.5)	5.7 (12.6)	6.0 (13.2)	4.6 (10.1)	4.8 (10.6)	3.9 (8.6)	4.1 (9)	
30m (98'5")	7.2 (15.9)	7.5 (16.5)	5.7 (12.6)	6.0 (13.2)	4.6 (10.1)	4.8 (10.6)	3.9 (8.6)	4.1 (9)	
32m (104'12")	7.2 (15.9)	7.5 (16.5)	5.7 (12.6)	6.0 (13.2)	4.6 (10.1)	4.8 (10.6)	3.9 (8.6)	4.1 (9)	
34m (111'7")	7.2 (15.9)	7.5 (16.5)	5.7 (12.6)	6.0 (13.2)	4.6 (10.1)	4.8 (10.6)	3.9 (8.6)	4.1 (9)	
36m (118'1")	7.2 (15.9)	7.5 (16.5)	5.7 (12.6)	6.0 (13.2)	4.6 (10.1)	4.8 (10.6)	3.9 (8.6)	4.1 (9)	
38m (124'8")	37.1/7.2 (121'9"/15.9)	37.1/7.5 (121'9"/16.5)	37.1/5.7 (121'9"/12.6)	37.1/6.0 (121'9"/13.2)	37.1/4.6 (121'9"/10.1)	37.1/4.8 (121'9"/10.6)	37.1/3.9 (121'9"/8.6)	37.1/4.1 (121'9"/9)	
Counterweight kg(lb)×1000	42 (92.6)	42+3 (92.6+6.6)	42 (92.6)	42+3 (92.6+6.6)	42 (92.6)	42+3 (92.6+6.6)	42 (92.6)	42+3 (92.6+6.6)	
Main Boom Length m(ft)	45m (147'8")								
Fixed Jib Length m(ft)	13m (42'8")				19m (62'4")				
Jib Angle	15°		30°		15°		30°		
Radius m(ft)									
14m (45'11")	15.1/11.0 (49'6"/24.3)	15.1/11.5 (49'6"/25.4)							
16m (52'6")	11.0 (24.3)	11.5 (25.4)							
18m (59'1")	11.0 (24.3)	11.5 (25.4)	18.2/8.0 (59'9"/17.6)	18.2/8.4 (59'9"/18.5)	18.1/7.2 (59'5"/15.9)	18.1/7.5 (59'5"/16.5)			
20m (65'7")	11.0 (24.3)	11.5 (25.4)	8.0 (17.6)	8.4 (18.5)	7.2 (15.9)	7.5 (16.5)			
22m (72'2")	11.0 (24.3)	11.5 (25.4)	8.0 (17.6)	8.4 (18.5)	7.2 (15.9)	7.5 (16.5)	22.3/5.7 (73'2"/12.6)	22.3/6.0 (73'2"/13.2)	
24m (78'9")	11.0 (24.3)	11.5 (25.4)	8.0 (17.6)	8.4 (18.5)	7.2 (15.9)	7.5 (16.5)	5.7 (12.6)	6.0 (13.2)	
26m (85'4")	11.0 (24.3)	11.5 (25.4)	8.0 (17.6)	8.4 (18.5)	7.2 (15.9)	7.5 (16.5)	5.7 (12.6)	6.0 (13.2)	
28m (91'10")	11.0 (24.3)	11.5 (25.4)	8.0 (17.6)	8.4 (18.5)	7.2 (15.9)	7.5 (16.5)	5.7 (12.6)	6.0 (13.2)	
30m (98'5")	30.3/11.0 (99'5"/24.3)	30.3/11.5 (99'5"/25.4)	8.0 (17.6)	8.4 (18.5)	7.2 (15.9)	7.5 (16.5)	5.7 (12.6)	6.0 (13.2)	
32m (104'12")	10.2 (22.5)	10.7 (23.6)	8.0 (17.6)	8.4 (18.5)	7.2 (15.9)	7.5 (16.5)	5.7 (12.6)	6.0 (13.2)	
34m (111'7")	9.2 (20.3)	9.6 (21.2)	8.0 (17.6)	8.4 (18.5)	7.2 (15.9)	7.5 (16.5)	5.7 (12.6)	6.0 (13.2)	
36m (118'1")	8.4 (18.5)	8.8 (19.4)	36.8/8.0 (120'9"/17.6)	36.8/8.4 (120'9"/18.5)	7.2 (15.9)	7.5 (16.5)	5.7 (12.6)	6.0 (13.2)	
38m (124'8")	8.1 (17.9)	8.5 (18.7)	7.8 (17.2)	8.2 (18.1)	7.2 (15.9)	7.5 (16.5)	5.7 (12.6)	6.0 (13.2)	
40m (131'3")	7.5 (16.5)	7.8 (17.2)	7.4 (16.3)	7.7 (17)	7.2 (15.9)	7.5 (16.5)	5.7 (12.6)	6.0 (13.2)	
42m (137'10")	40.3/7.4 (132'3"/16.3)	40.3/7.7 (132'3"/17)	40.3/7.3 (132'3"/16.1)	40.3/7.6 (132'3"/16.8)	40.3/7.2 (132'3"/15.9)	40.3/7.5 (132'3"/16.5)	40.3/5.7 (132'3"/12.6)	40.3/6.0 (132'3"/13.2)	
Counterweight kg(lb)×1000	42 (92.6)	42+3 (92.6+6.6)	42 (92.6)	42+3 (92.6+6.6)	42 (92.6)	42+3 (92.6+6.6)	42 (92.6)	42+3 (92.6+6.6)	

Note: 1. The actual hoisting weight is the value that rated load in the table deducts the weight of hook block and other lifting tools.

2. Rated hoisting load in this table is the weight lifted from level and hard ground.

3. The italic values in grey filling table means the operating condition under which standard counterweight and additional counterweight are included.



Fixed Jib Load Charts 3/10								kg(lb)×1000	
Main Boom Length m(ft)	45m (147'8")				48m (157'6")				
Fixed Jib Length m(ft)	25m (82'0")				13m (42'8")				
Jib Angle	15°		30°		15°		30°		
Radius m(ft)	15°		30°		15°		30°		
16m (52'6")					15.9/11.0 (52'2"/24.3)	15.9/11.5 (52'2"/25.4)			
18m (59'1")					11.0 (24.3)	11.5 (25.4)	18.4/8.0 (60'4"/17.6)	18.4/8.4 (60'4"/18.5)	
20m (65'7")	20.7/4.6 (67'11"/10.1)	20.7/4.8 (67'11"/10.6)			11.0 (24.3)	11.5 (25.4)	8.0 (17.6)	8.4 (18.5)	
22m (72'2")	4.6 (10.1)	4.8 (5.3)			11.0 (24.3)	11.5 (25.4)	8.0 (17.6)	8.4 (18.5)	
24m (78'9")	4.6 (10.1)	4.8 (10.6)	25.9/3.9 (84'12"/8.6)	25.9/4.1 (84'12"/9)	11.0 (24.3)	11.5 (25.4)	8.0 (17.6)	8.4 (18.5)	
26m (85'4")	4.6 (10.1)	4.8 (10.6)	3.9 (8.6)	4.1 (9)	11.0 (24.3)	11.5 (25.4)	8.0 (17.6)	8.4 (18.5)	
28m (91'10")	4.6 (10.1)	4.8 (10.6)	3.9 (8.6)	4.1 (9)	11.0 (24.3)	11.5 (25.4)	8.0 (17.6)	8.4 (18.5)	
30m (98'5")	4.6 (10.1)	4.8 (10.6)	3.9 (8.6)	4.1 (9)	30.1/11.0 (98'9"/24.3)	30.1/11.5 (98'9"/25.4)	8.0 (17.6)	8.4 (18.5)	
32m (104'12")	4.6 (10.1)	4.8 (10.6)	3.9 (8.6)	4.1 (9)	10.1 (22.3)	10.6 (23.4)	8.0 (17.6)	8.4 (18.5)	
34m (111'7")	4.6 (10.1)	4.8 (10.6)	3.9 (8.6)	4.1 (9)	9.1 (20.1)	9.5 (20.9)	8.0 (17.6)	8.4 (18.5)	
36m (118'1")	4.6 (10.1)	4.8 (10.6)	3.9 (8.6)	4.1 (9)	8.2 (18.1)	8.6 (19)	8.0 (17.6)	8.4 (18.5)	
38m (124'8")	4.6 (10.1)	4.8 (10.6)	3.9 (8.6)	4.1 (9)	8.0 (17.6)	8.4 (18.5)	7.4 (16.3)	7.7 (17)	
40m (131'3")	4.6 (10.1)	4.8 (10.6)	3.9 (8.6)	4.1 (9)	7.3 (16.1)	7.6 (16.8)	7.3 (16.1)	7.6 (16.8)	
42m (137'10")	40.3/4.6 (132'3"/10.1)	40.3/4.8 (132'3"/10.6)	40.3/3.9 (132'3"/8.6)	40.3/4.1 (132'3"/9)	7.1 (15.7)	7.4 (16.3)	7.1 (15.7)	7.4 (16.3)	
44m (144'4")					42.8/6.9 (140'5"/15.2)	42.8/7.2 (140'5"/15.9)	42.8/6.8 (140'5"/15)	42.8/7.1 (140'5"/15.7)	
Counterweight kg(lb)×1000	42 (92.6)	(42+3) (92.6+6.6)	42 (92.6)	(42+3) (92.6+6.6)	42 (92.6)	(42+3) (92.6+6.6)	42 (92.6)	(42+3) (92.6+6.6)	

Fixed Jib Load Charts 3/10								kg(lb)×1000	
Main Boom Length m(ft)	48m (157'6")				25m (82'0")				
Fixed Jib Length m(ft)	19m (62'4")				25m (82'0")				
Jib Angle	15°		30°		15°		30°		
Radius m(ft)	15°		30°		15°		30°		
18m (59'1")	18.2/7.2 (59'9"/15.9)	18.2/7.5 (59'9"/16.5)							
20m (65'7")	7.2 (15.9)	7.5 (16.5)			21.2/4.6 (69'7"/10.1)	21.2/4.8 (69'7"/10.6)			
22m (72'2")	7.2 (15.9)	7.5 (16.5)	22.7/5.7 (74'6"/12.6)	22.7/6.0 (74'6"/13.2)	4.6 (10.1)	4.8 (10.6)			
24m (78'9")	7.2 (15.9)	7.5 (16.5)	5.7 (12.6)	6.0 (13.2)	4.6 (10.1)	4.8 (10.6)			
26m (85'4")	7.2 (15.9)	7.5 (16.5)	5.7 (12.6)	6.0 (13.2)	4.6 (10.1)	4.8 (10.6)	26.5/3.9 (86'11"/8.6)	26.5/4.1 (86'11"/9)	
28m (91'10")	7.2 (15.9)	7.5 (16.5)	5.7 (12.6)	6.0 (13.2)	4.6 (10.1)	4.8 (10.6)	3.9 (8.6)	4.1 (9)	
30m (98'5")	7.2 (15.9)	7.5 (16.5)	5.7 (12.6)	6.0 (13.2)	4.6 (10.1)	4.8 (10.6)	3.9 (8.6)	4.1 (9)	
32m (104'12")	7.2 (15.9)	7.5 (16.5)	5.7 (12.6)	6.0 (13.2)	4.6 (10.1)	4.8 (10.6)	3.9 (8.6)	4.1 (9)	
34m (111'7")	7.2 (15.9)	7.5 (16.5)	5.7 (12.6)	6.0 (13.2)	4.6 (10.1)	4.8 (10.6)	3.9 (8.6)	4.1 (9)	
36m (118'1")	7.2 (15.9)	7.5 (16.5)	5.7 (12.6)	6.0 (13.2)	4.6 (10.1)	4.8 (10.6)	3.9 (8.6)	4.1 (9)	
38m (124'8")	7.2 (15.9)	7.5 (16.5)	5.7 (12.6)	6.0 (13.2)	4.6 (10.1)	4.8 (10.6)	3.9 (8.6)	4.1 (9)	
40m (131'3")	7.2 (15.9)	7.5 (16.5)	5.7 (12.6)	6.0 (13.2)	4.6 (10.1)	4.8 (10.6)	3.9 (8.6)	4.1 (9)	
42m (137'10")	7.0 (15.4)	7.3 (16.1)	5.7 (12.6)	6.0 (13.2)	4.6 (10.1)	4.8 (10.6)	3.9 (8.6)	4.1 (9)	
44m (144'4")	42.8/6.7 (140'5"/14.8)	42.8/7.0 (140'5"/15.4)	42.8/5.7 (140'5"/12.6)	42.8/6.0 (140'5"/13.2)	42.8/4.6 (140'5"/10.1)	42.8/4.8 (140'5"/10.6)	42.8/3.9 (140'5"/8.6)	42.8/4.1 (140'5"/9)	
Counterweight kg(lb)×1000	42 (92.6)	(42+3) (92.6+6.6)	42 (92.6)	(42+3) (92.6+6.6)	42 (92.6)	(42+3) (92.6+6.6)	42 (92.6)	(42+3) (92.6+6.6)	

Note: 1. The actual hoisting weight is the value that rated load in the table deducts the weight of hook block and other lifting tools.

2. Rated hoisting load in this table is the weight lifted from level and hard ground.

3. The italic values in grey filling table means the operating condition under which standard counterweight and additional counterweight are included.



Fixed Jib Load Charts 4/10									kg(lb)×1000
Main Boom Length m(ft)	51m (167'4")								
Fixed Jib Length m(ft)	13m (42'8")				19m (62'4")				
Jib Angle Radius m(ft)	15°		30°		15°		30°		
16m (52'6")	16.3/11.0 (53'6"/24.3)	16.3/11.5 (53'6"/25.4)							
18m (59'1")	11.0 (24.3)	11.5 (25.4)	19.1/8.0 (62'8"/17.6)	19.1/8.4 (62'8"/18.5)	18.7/7.2 (61'4"/15.9)	18.7/7.5 (61'4"/16.5)			
20m (65'7")	11.0 (24.3)	11.5 (25.4)	8.0 (17.6)	8.4 (18.5)	7.2 (15.9)	7.5 (16.5)			
22m (72'2")	11.0 (24.3)	11.5 (25.4)	8.0 (17.6)	8.4 (18.5)	7.2 (15.9)	7.5 (16.5)	23.4/5.7 (76'9"/12.6)	23.4/6.0 (76'9"/13.2)	
24m (78'9")	11.0 (24.3)	11.5 (25.4)	8.0 (17.6)	8.4 (18.5)	7.2 (15.9)	7.5 (16.5)	5.7 (12.6)	6.0 (13.2)	
26m (85'4")	11.0 (24.3)	11.5 (25.4)	8.0 (17.6)	8.4 (18.5)	7.2 (15.9)	7.5 (16.5)	5.7 (12.6)	6.0 (13.2)	
28m (91'10")	11.0 (24.3)	11.5 (25.4)	8.0 (17.6)	8.4 (18.5)	7.2 (15.9)	7.5 (16.5)	5.7 (12.6)	6.0 (13.2)	
30m (98'5")	29.6/11.0 (97'1"/24.3)	29.6/11.5 (97'1"/25.4)	8.0 (17.6)	8.4 (18.5)	7.2 (15.9)	7.5 (16.5)	5.7 (12.6)	6.0 (13.2)	
32m (104'12")	9.9 (21.8)	10.3 (22.7)	8.0 (17.6)	8.4 (18.5)	7.2 (15.9)	7.5 (16.5)	5.7 (12.6)	6.0 (13.2)	
34m (111'7")	9.0 (19.8)	9.4 (20.7)	8.0 (17.6)	8.4 (18.5)	7.2 (15.9)	7.5 (16.5)	5.7 (12.6)	6.0 (13.2)	
36m (118'1")	8.1 (17.9)	8.5 (18.7)	36.2/8.0 (118'9"/17.6)	36.2/8.4 (118'9"/18.5)	7.2 (15.9)	7.5 (16.5)	5.7 (12.6)	6.0 (13.2)	
38m (124'8")	8.0 (17.6)	8.4 (18.5)	7.3 (16.1)	7.6 (16.8)	7.2 (15.9)	7.5 (16.5)	5.7 (12.6)	6.0 (13.2)	
40m (131'3")	7.2 (15.9)	7.5 (16.5)	7.1 (15.7)	7.4 (16.3)	40.9/7.2 (134'2"/15.9)	40.9/7.5 (134'2"/16.5)	5.7 (12.6)	6.0 (13.2)	
42m (137'10")	6.9 (15.2)	7.2 (15.9)	6.9 (15.2)	7.2 (15.9)	6.8 (15)	7.1 (15.7)	5.7 (12.6)	6.0 (13.2)	
44m (144'4")	6.7 (14.8)	7.0 (15.4)	6.7 (14.8)	7.0 (15.4)	6.6 (14.6)	6.9 (15.2)	5.7 (12.6)	6.0 (13.2)	
46m (150'11")	44.6/6.2 (146'4"/13.7)	44.6/6.5 (146'4"/14.3)	44.6/6.2 (146'4"/13.7)	44.6/6.5 (146'4"/14.3)	44.6/6.1 (146'4"/13.4)	44.6/6.4 (146'4"/14.1)	44.6/5.7 (146'4"/12.6)	44.6/6.0 (146'4"/13.2)	
Counterweight kg(lb)×1000	42 (92.6)	(42+3) (92.6+6.6)	42 (92.6)	(42+3) (92.6+6.6)	42 (92.6)	(42+3) (92.6+6.6)	42 (92.6)	(42+3) (92.6+6.6)	

Note: 1. The actual hoisting weight is the value that rated load in the table deducts the weight of hook block and other lifting tools.

2. Rated hoisting load in this table is the weight lifted from level and hard ground.

3. The italic values in grey filling table means the operating condition under which standard counterweight and additional counterweight are included.



Fixed Jib Load Charts 5/10									kg(lb)×1000
Main Boom Length m(ft)	51m (167'4")				54m (177'2")				
Fixed Jib Length m(ft)	25m (82'0")				13m (42'8")				
Jib Angle Radius m(ft)	15°		30°		15°		30°		
16m (52'6")					17.1/11.0 (56'1"/24.3)	17.1/11.5 (56'1"/25.4)			
18m (59'1")					11.0 (24.3)	11.5 (25.4)			
20m (65'7")					11.0 (24.3)	11.5 (25.4)	20.1/8.0 (65'11"/17.6)	20.1/8.4 (65'11"/18.5)	
22m (72'2")	21.9/4.6 (71'10"/10.1)	21.9/4.8 (71'10"/10.6)	21.5/3.9 (70'6"/8.6)	21.5/4.1 (70'6"/9)	11.0 (24.3)	11.5 (25.4)	8.0 (17.6)	8.4 (18.5)	
24m (78'9")	4.6 (10.1)	4.8 (10.6)	3.9 (8.6)	4.1 (9)	11.0 (24.3)	11.5 (25.4)	8.0 (17.6)	8.4 (18.5)	
26m (85'4")	4.6 (10.1)	4.8 (10.6)	3.9 (8.6)	4.1 (9)	11.0 (24.3)	11.5 (25.4)	8.0 (17.6)	8.4 (18.5)	
28m (91'10")	4.6 (10.1)	4.8 (10.6)	3.9 (8.6)	4.1 (9)	11.0 (24.3)	11.5 (25.4)	8.0 (17.6)	8.4 (18.5)	
30m (98'5")	4.6 (10.1)	4.8 (10.6)	3.9 (8.6)	4.1 (9)	11.0 (24.3)	11.5 (25.4)	8.0 (17.6)	8.4 (18.5)	
32m (104'12")	4.6 (10.1)	4.8 (10.6)	3.9 (8.6)	4.1 (9)	9.8 (21.6)	10.2 (22.5)	8.0 (17.6)	8.4 (18.5)	
34m (111'7")	4.6 (10.1)	4.8 (10.6)	3.9 (8.6)	4.1 (9)	8.9 (19.6)	9.3 (20.5)	8.0 (17.6)	8.4 (18.5)	
36m (118'1")	4.6 (10.1)	4.8 (10.6)	3.9 (8.6)	4.1 (9)	8.1 (17.9)	8.5 (18.7)	8.0 (17.6)	8.4 (18.5)	
38m (124'8")	4.6 (10.1)	4.8 (10.6)	3.9 (8.6)	4.1 (9)	8.0 (17.6)	8.4 (18.5)	7.2 (15.9)	7.5 (16.5)	
40m (131'3")	4.6 (10.1)	4.8 (10.6)	3.9 (8.6)	4.1 (9)	7.1 (15.7)	7.4 (16.3)	7.0 (15.4)	7.3 (16.1)	
42m (137'10")	4.6 (10.1)	4.8 (10.6)	3.9 (8.6)	4.1 (9)	6.7 (14.8)	7.0 (15.4)	6.6 (14.6)	6.9 (15.2)	
44m (144'4")	4.6 (10.1)	4.8 (10.6)	3.9 (8.6)	4.1 (9)	6.6 (14.6)	6.9 (15.2)	6.5 (14.3)	6.8 (15)	
46m (150'11")	44.6/4.6 (146'4"/10.1)	44.6/4.8 (146'4"/10.6)	44.6/3.9 (146'4"/8.6)	44.6/4.1 (146'4"/9)	6.1 (13.4)	6.4 (14.1)	6.1 (13.4)	6.4 (14.1)	
48m (157'6")					5.8 (12.8)	6.1 (13.4)	5.8 (12.8)	6.1 (13.4)	
50m (164'0")					48.1/5.7 (157'10"/12.6)	48.1/6.0 (157'10"/13.2)	48.1/5.7 (157'10"/12.6)	48.1/6.0 (157'10"/13.2)	
Counterweight kg(lb)×1000	42 (92.6)	(42+3) (92.6+6.6)	42 (92.6)	(42+3) (92.6+6.6)	42 (92.6)	(42+3) (92.6+6.6)	42 (92.6)	(42+3) (92.6+6.6)	

Note: 1. The actual hoisting weight is the value that rated load in the table deducts the weight of hook block and other lifting tools.

2. Rated hoisting load in this table is the weight lifted from level and hard ground.

3. The italic values in grey filling table means the operating condition under which standard counterweight and additional counterweight are included.



Fixed Jib Load Charts 6/10									kg(lb)×1000
Main Boom Length m(ft)	54m (177'2")								
Fixed Jib Length m(ft)	19m (62'4")				25m (82'0")				
Jib Angle Radius m(ft)	15°		30°		15°		30°		
20m (65'7")	20.0/7.2 (65'7"/15.9)	<i>20.0/7.5 (65'7"/16.5)</i>							
22m (72'2")	7.2 (15.9)	<i>7.5 (16.5)</i>			22.3/4.6 (73'2"/10.1)	<i>22.3/4.8 (73'2"/10.6)</i>			
24m (78'9")	7.2 (15.9)	<i>7.5 (16.5)</i>	25.2/5.7 (82'8"/12.6)	<i>25.2/6.0 (82'8"/13.2)</i>	4.6 (10.1)	<i>4.8 (10.6)</i>			
26m (85'4")	7.2 (15.9)	<i>7.5 (16.5)</i>	5.7 (12.6)	<i>6.0 (13.2)</i>	4.6 (10.1)	<i>4.8 (10.6)</i>			
28m (91'10")	7.2 (15.9)	<i>7.5 (16.5)</i>	5.7 (12.6)	<i>6.0 (13.2)</i>	4.6 (10.1)	<i>4.8 (10.6)</i>	28.1/3.9 (92'2"/8.6)	<i>28.1/4.1 (92'2"/9)</i>	
30m (98'5")	7.2 (15.9)	<i>7.5 (16.5)</i>	5.7 (12.6)	<i>6.0 (13.2)</i>	4.6 (10.1)	<i>4.8 (10.6)</i>	3.9 (8.6)	<i>4.1 (9)</i>	
32m (104'12")	7.2 (15.9)	<i>7.5 (16.5)</i>	5.7 (12.6)	<i>6.0 (13.2)</i>	4.6 (10.1)	<i>4.8 (10.6)</i>	3.9 (8.6)	<i>4.1 (9)</i>	
34m (111'7")	7.2 (15.9)	<i>7.5 (16.5)</i>	5.7 (12.6)	<i>6.0 (13.2)</i>	4.6 (10.1)	<i>4.8 (10.6)</i>	3.9 (8.6)	<i>4.1 (9)</i>	
36m (118'1")	7.2 (15.9)	<i>7.5 (16.5)</i>	5.7 (12.6)	<i>6.0 (13.2)</i>	4.6 (10.1)	<i>4.8 (10.6)</i>	3.9 (8.6)	<i>4.1 (9)</i>	
38m (124'8")	37.8/7.2 (124'0"/15.9)	<i>37.8/7.5 (124'0"/16.5)</i>	5.7 (12.6)	<i>6.0 (13.2)</i>	4.6 (10.1)	<i>4.8 (10.6)</i>	3.9 (8.6)	<i>4.1 (9)</i>	
40m (131'3")	7.0 (15.4)	<i>7.3 (16.1)</i>	5.7 (12.6)	<i>6.0 (13.2)</i>	4.6 (10.1)	<i>4.8 (10.6)</i>	3.9 (8.6)	<i>4.1 (9)</i>	
42m (137'10")	6.5 (14.3)	<i>6.8 (15)</i>	5.7 (12.6)	<i>6.0 (13.2)</i>	4.6 (10.1)	<i>4.8 (10.6)</i>	3.9 (8.6)	<i>4.1 (9)</i>	
44m (144'4")	6.4 (14.1)	<i>6.7 (14.8)</i>	5.7 (12.6)	<i>6.0 (13.2)</i>	4.6 (10.1)	<i>4.8 (10.6)</i>	3.9 (8.6)	<i>4.1 (9)</i>	
46m (150'11")	6.1 (13.4)	<i>6.4 (14.1)</i>	5.7 (12.6)	<i>6.0 (13.2)</i>	4.6 (10.1)	<i>4.8 (10.6)</i>	3.9 (8.6)	<i>4.1 (9)</i>	
48m (157'6")	5.7 (12.6)	<i>6.0 (13.2)</i>	5.7 (12.6)	<i>6.0 (13.2)</i>	4.6 (10.1)	<i>4.8 (10.6)</i>	3.9 (8.6)	<i>4.1 (9)</i>	
50m (164'0")	48.1/5.7 (157'10"/12.6)	<i>48.1/6.0 (157'10"/13.2)</i>	48.1/5.7 (157'10"/12.6)	<i>48.1/6.0 (157'10"/13.2)</i>	48.1/4.6 (157'10"/10.1)	<i>48.1/4.8 (157'10"/10.6)</i>	48.1/3.9 (157'10"/8.6)	<i>48.1/4.1 (157'10"/9)</i>	
Counterweight kg(lb)×1000	42 (92.6)	<i>(42+3) (92.6+6.6)</i>	42 (92.6)	<i>(42+3) (92.6+6.6)</i>	42 (92.6)	<i>(42+3) (92.6+6.6)</i>	42 (92.6)	<i>(42+3) (92.6+6.6)</i>	

Note: 1. The actual hoisting weight is the value that rated load in the table deducts the weight of hook block and other lifting tools.

2. Rated hoisting load in this table is the weight lifted from level and hard ground.

3. The italic values in grey filling table means the operating condition under which standard counterweight and additional counterweight are included.



Fixed Jib Load Charts 7/10									kg(lb)×1000
Main Boom Length m(ft)	57m (187'0")								
Fixed Jib Length m(ft)	13m (42'8")				19m (62'4")				
Jib Angle Radius m(ft)	15°		30°		15°		30°		
18m (59'1")	18.3/11.0 (60'0"/24.3)	<i>18.3/11.5 (60'0"/25.4)</i>							
20m (65'7")	11.0 (24.3)	<i>11.5 (25.4)</i>	20.6/8.0 (67'7"/17.6)	<i>20.6/8.4 (67'7"/18.5)</i>	20.4/7.2 (66'11"/15.9)	<i>20.4/7.5 (66'11"/16.5)</i>			
22m (72'2")	11.0 (24.3)	<i>11.5 (25.4)</i>	8.0 (17.6)	<i>8.4 (18.5)</i>	7.2 (15.9)	<i>7.5 (16.5)</i>			
24m (78'9")	11.0 (24.3)	<i>11.5 (25.4)</i>	8.0 (17.6)	<i>8.4 (18.5)</i>	7.2 (15.9)	<i>7.5 (16.5)</i>	24.6/5.7 (80'8"/12.6)	<i>24.6/6.0 (80'8"/13.2)</i>	
26m (85'4")	11.0 (24.3)	<i>11.5 (25.4)</i>	8.0 (17.6)	<i>8.4 (18.5)</i>	7.2 (15.9)	<i>7.5 (16.5)</i>	5.7 (12.6)	<i>6.0 (13.2)</i>	
28m (91'10")	29.3/11.0 (96'2"/24.3)	<i>29.3/11.5 (96'2"/25.4)</i>	8.0 (17.6)	<i>8.4 (18.5)</i>	7.2 (15.9)	<i>7.5 (16.5)</i>	5.7 (12.6)	<i>6.0 (13.2)</i>	
30m (98'5")	9.7 (21.4)	<i>10.1 (22.3)</i>	8.0 (17.6)	<i>8.4 (18.5)</i>	7.2 (15.9)	<i>7.5 (16.5)</i>	5.7 (12.6)	<i>6.0 (13.2)</i>	
32m (104'12")	9.5 (20.9)	<i>9.9 (21.8)</i>	8.0 (17.6)	<i>8.4 (18.5)</i>	7.2 (15.9)	<i>7.5 (16.5)</i>	5.7 (12.6)	<i>6.0 (13.2)</i>	
34m (111'7")	8.7 (19.2)	<i>9.1 (20.1)</i>	8.0 (17.6)	<i>8.4 (18.5)</i>	7.2 (15.9)	<i>7.5 (16.5)</i>	5.7 (12.6)	<i>6.0 (13.2)</i>	
36m (118'1")	8.0 (17.6)	<i>8.4 (18.5)</i>	37.1/8.0 (121'9"/17.6)	<i>37.1/8.4 (121'9"/18.5)</i>	7.2 (15.9)	<i>7.5 (16.5)</i>	5.7 (12.6)	<i>6.0 (13.2)</i>	
38m (124'8")	7.8 (17.2)	<i>8.2 (18.1)</i>	7.2 (15.9)	<i>7.5 (16.5)</i>	38.7/7.2 (126'12"/15.9)	<i>38.7/7.5 (126'12"/16.5)</i>	5.7 (12.6)	<i>6.0 (13.2)</i>	
40m (131'3")	7.0 (15.4)	<i>7.3 (16.1)</i>	6.8 (15)	<i>7.1 (15.7)</i>	7.0 (15.4)	<i>7.3 (16.1)</i>	5.7 (12.6)	<i>6.0 (13.2)</i>	
42m (137'10")	6.5 (14.3)	<i>6.8 (15)</i>	6.4 (14.1)	<i>6.7 (14.8)</i>	6.2 (13.7)	<i>6.5 (14.3)</i>	5.7 (12.6)	<i>6.0 (13.2)</i>	
44m (144'4")	6.4 (14.1)	<i>6.7 (14.8)</i>	6.3 (13.9)	<i>6.6 (14.6)</i>	6.1 (13.4)	<i>6.4 (14.1)</i>	5.7 (12.6)	<i>6.0 (13.2)</i>	
46m (150'11")	6.0 (13.2)	<i>6.3 (13.9)</i>	6.0 (13.2)	<i>6.3 (13.9)</i>	6.0 (13.2)	<i>6.3 (13.9)</i>	47.1/5.7 (154'6"/12.6)	<i>47.1/6.0 (154'6"/13.2)</i>	
48m (157'6")	5.7 (12.6)	<i>6.0 (13.2)</i>	5.7 (12.6)	<i>6.0 (13.2)</i>	5.6 (12.3)	<i>5.9 (13)</i>	5.5 (12.1)	<i>5.8 (12.8)</i>	
50m (164'0")	5.5 (12.1)	<i>5.7 (12.6)</i>	5.4 (11.9)	<i>5.6 (12.3)</i>	5.3 (11.7)	<i>5.5 (12.1)</i>	5.2 (11.5)	<i>5.5 (12.1)</i>	
52m (170'7")	50.5/5.1 (165'8"/11.2)	<i>50.5/5.3 (165'8"/11.7)</i>	50.5/5.0 (165'8"/11)	<i>50.5/5.2 (165'8"/11.5)</i>	50.5/4.9 (165'8"/10.8)	<i>50.5/5.1 (165'8"/11.2)</i>	50.5/4.8 (165'8"/10.6)	<i>50.5/5.1 (165'8"/11.2)</i>	
Counterweight kg(lb)×1000	42 (92.6)	(42+3) (92.6+6.6)	42 (92.6)	(42+3) (92.6+6.6)	42 (92.6)	(42+3) (92.6+6.6)	42 (92.6)	(42+3) (92.6+6.6)	

Note: 1. The actual hoisting weight is the value that rated load in the table deducts the weight of hook block and other lifting tools.

2. Rated hoisting load in this table is the weight lifted from level and hard ground.

3. The italic values in grey filling table means the operating condition under which standard counterweight and additional counterweight are included.



Fixed Jib Load Charts 8/10									kg(lb)×1000
Main Boom Length m(ft)	57m (187'0")				60m (196'10")				
Fixed Jib Length m(ft)	25m (82'0")				13m (42'8")				
Jib Angle Radius m(ft)	15°		30°		15°		30°		
18m (59'1")					18.2/11.0 (59'9"/24.3)	18.2/11.5 (59'9"/25.4)			
20m (65'7")					11.0 (24.3)	11.5 (25.4)	21.2/8.0 (69'7"/17.6)	21.2/8.4 (69'7"/18.5)	
22m (72'2")	23.1/4.6 (75'9"/10.1)	23.1/4.8 (75'9"/10.6)			11.0 (24.3)	11.5 (25.4)	8.0 (17.6)	8.4 (18.5)	
24m (78'9")	4.6 (10.1)	4.8 (10.6)			11.0 (24.3)	11.5 (25.4)	8.0 (17.6)	8.4 (18.5)	
26m (85'4")	4.6 (10.1)	4.8 (10.6)			11.0 (24.3)	11.5 (25.4)	8.0 (17.6)	8.4 (18.5)	
28m (91'10")	4.6 (10.1)	4.8 (10.6)	28.2/3.9 (92'6"/8.6)	28.2/4.1 (92'6"/9)	29.7/11.0 (97'5"/24.3)	29.7/11.5 (97'5"/25.4)	8.0 (17.6)	8.4 (18.5)	
30m (98'5")	4.6 (10.1)	4.8 (10.6)	3.9 (8.6)	4.1 (9)	9.6 (21.2)	10.0 (22)	8.0 (17.6)	8.4 (18.5)	
32m (104'12")	4.6 (10.1)	4.8 (10.6)	3.9 (8.6)	4.1 (9)	9.4 (20.7)	9.8 (21.6)	8.0 (17.6)	8.4 (18.5)	
34m (111'7")	4.6 (10.1)	4.8 (10.6)	3.9 (8.6)	4.1 (9)	8.5 (18.7)	8.9 (19.6)	8.0 (17.6)	8.4 (18.5)	
36m (118'1")	4.6 (10.1)	4.8 (10.6)	3.9 (8.6)	4.1 (9)	8.0 (17.6)	8.4 (18.5)	36.3/8.0 (119'1"/17.6)	36.3/8.4 (119'1"/18.5)	
38m (124'8")	4.6 (10.1)	4.8 (10.6)	3.9 (8.6)	4.1 (9)	7.6 (16.8)	7.9 (17.4)	7.2 (15.9)	7.5 (16.5)	
40m (131'3")	4.6 (10.1)	4.8 (10.6)	3.9 (8.6)	4.1 (9)	6.9 (15.2)	7.2 (15.9)	6.7 (14.8)	7.0 (15.4)	
42m (137'10")	4.6 (10.1)	4.8 (10.6)	3.9 (8.6)	4.1 (9)	6.4 (14.1)	6.7 (14.8)	6.3 (13.9)	6.6 (14.6)	
44m (144'4")	4.6 (10.1)	4.8 (10.6)	3.9 (8.6)	4.1 (9)	6.2 (13.7)	6.5 (14.3)	6.1 (13.4)	6.4 (14.1)	
46m (150'11")	4.6 (10.1)	4.8 (10.6)	3.9 (8.6)	4.1 (9)	5.8 (12.8)	6.1 (13.4)	5.7 (12.6)	6.0 (13.2)	
48m (157'6")	4.6 (10.1)	4.8 (10.6)	3.9 (8.6)	4.1 (9)	5.5 (12.1)	5.7 (12.6)	5.4 (11.9)	5.6 (12.3)	
50m (164'0")	4.6 (10.1)	4.8 (10.6)	3.9 (8.6)	4.1 (9)	5.4 (11.9)	5.6 (12.3)	5.2 (11.5)	5.4 (11.9)	
52m (170'7")	50.5/4.6 (165'8"/10.1)	50.5/4.8 (165'8"/10.6)	50.5/3.9 (165'8"/8.6)	50.5/4.1 (165'8"/9)	5.0 (11)	5.2 (11.5)	4.9 (10.8)	5.1 (11.2)	
54m (177'2")					52.8/4.4 (173'3"/9.7)	52.8/4.6 (173'3"/10.1)	52.8/4.3 (173'3"/9.5)	52.8/4.5 (173'3"/9.9)	
Counterweight kg(lb)×1000	42 (92.6)	(42+3) (92.6+6.6)	42 (92.6)	(42+3) (92.6+6.6)	42 (92.6)	(42+3) (92.6+6.6)	42 (92.6)	(42+3) (92.6+6.6)	

Note: 1. The actual hoisting weight is the value that rated load in the table deducts the weight of hook block and other lifting tools.

2. Rated hoisting load in this table is the weight lifted from level and hard ground.

3. The italic values in grey filling table means the operating condition under which standard counterweight and additional counterweight are included.



Fixed Jib Load Charts 9/10									kg(lb)×1000
Main Boom Length m(ft)	60m (196'10")								
Fixed Jib Length m(ft)	19m (62'4")				25m (82'0")				
Jib Angle Radius m(ft)	15°		30°		15°		30°		
20m (65'7")	21.0/7.2 (68'11"/15.9)	<i>21.0/7.5 (68'11"/16.5)</i>							
22m (72'2")	7.2 (15.9)	<i>7.5 (16.5)</i>			23.5/4.6 (77'1"/10.1)	<i>23.5/4.8 (77'1"/10.6)</i>			
24m (78'9")	7.2 (15.9)	<i>7.5 (16.5)</i>	24.4/5.7 (80'1"/12.6)	<i>24.4/6.0 (80'1"/13.2)</i>	4.6 (10.1)	<i>4.8 (10.6)</i>			
26m (85'4")	7.2 (15.9)	<i>7.5 (16.5)</i>	5.7 (12.6)	<i>6.0 (13.2)</i>	4.6 (10.1)	<i>4.8 (10.6)</i>			
28m (91'10")	7.2 (15.9)	<i>7.5 (16.5)</i>	5.7 (12.6)	<i>6.0 (13.2)</i>	4.6 (10.1)	<i>4.8 (10.6)</i>	29.1/3.9 (95'6"/8.6)	<i>29.1/4.1 (95'6"/9)</i>	
30m (98'5")	7.2 (15.9)	<i>7.5 (16.5)</i>	5.7 (12.6)	<i>6.0 (13.2)</i>	4.6 (10.1)	<i>4.8 (10.6)</i>	3.9 (8.6)	<i>4.1 (9)</i>	
32m (104'12")	7.2 (15.9)	<i>7.5 (16.5)</i>	5.7 (12.6)	<i>6.0 (13.2)</i>	4.6 (10.1)	<i>4.8 (10.6)</i>	3.9 (8.6)	<i>4.1 (9)</i>	
34m (111'7")	7.2 (15.9)	<i>7.5 (16.5)</i>	5.7 (12.6)	<i>6.0 (13.2)</i>	4.6 (10.1)	<i>4.8 (10.6)</i>	3.9 (8.6)	<i>4.1 (9)</i>	
36m (118'1")	7.2 (15.9)	<i>7.5 (16.5)</i>	5.7 (12.6)	<i>6.0 (13.2)</i>	4.6 (10.1)	<i>4.8 (10.6)</i>	3.9 (8.6)	<i>4.1 (9)</i>	
38m (124'8")	38.2/7.2 (125'4"/15.9)	<i>38.2/7.5 (125'4"/16.5)</i>	5.7 (12.6)	<i>6.0 (13.2)</i>	4.6 (10.1)	<i>4.8 (10.6)</i>	3.9 (8.6)	<i>4.1 (9)</i>	
40m (131'3")	6.6 (14.6)	<i>6.9 (15.2)</i>	5.7 (12.6)	<i>6.0 (13.2)</i>	4.6 (10.1)	<i>4.8 (10.6)</i>	3.9 (8.6)	<i>4.1 (9)</i>	
42m (137'10")	6.2 (13.7)	<i>6.5 (14.3)</i>	5.7 (12.6)	<i>6.0 (13.2)</i>	4.6 (10.1)	<i>4.8 (10.6)</i>	3.9 (8.6)	<i>4.1 (9)</i>	
44m (144'4")	6.0 (13.2)	<i>6.3 (13.9)</i>	5.7 (12.6)	<i>6.0 (13.2)</i>	4.6 (10.1)	<i>4.8 (10.6)</i>	3.9 (8.6)	<i>4.1 (9)</i>	
46m (150'11")	5.7 (12.6)	<i>6.0 (13.2)</i>	46.8/5.7 (153'6"/12.6)	<i>46.8/6.0 (153'6"/13.2)</i>	4.6 (10.1)	<i>4.8 (10.6)</i>	3.9 (8.6)	<i>4.1 (9)</i>	
48m (157'6")	5.3 (11.7)	<i>5.5 (12.1)</i>	5.2 (11.5)	<i>5.5 (12.1)</i>	4.6 (10.1)	<i>4.8 (10.6)</i>	3.9 (8.6)	<i>4.1 (9)</i>	
50m (164'0")	5.1 (11.2)	<i>5.3 (11.7)</i>	5.0 (11)	<i>5.3 (11.7)</i>	4.6 (10.1)	<i>4.8 (10.6)</i>	3.9 (8.6)	<i>4.1 (9)</i>	
52m (170'7")	4.8 (10.6)	<i>5.0 (11)</i>	4.6 (10.1)	<i>4.9 (10.8)</i>	4.6 (10.1)	<i>4.8 (10.6)</i>	3.9 (8.6)	<i>4.1 (9)</i>	
54m (177'2")	52.8/4.3 (173'3"/9.5)	<i>52.8/4.5 (173'3"/9.9)</i>	52.8/4.3 (173'3"/9.5)	<i>52.8/4.6 (173'3"/10.1)</i>	52.8/4.2 (173'3"/9.3)	<i>52.8/4.4 (173'3"/9.7)</i>	52.8/3.9 (173'3"/8.6)	<i>52.8/4.1 (173'3"/9)</i>	
Counterweight kg(lb)×1000	42 (92.6)	(42+3) (92.6+6.6)	42 (92.6)	(42+3) (92.6+6.6)	42 (92.6)	(42+3) (92.6+6.6)	42 (92.6)	(42+3) (92.6+6.6)	

Note: 1. The actual hoisting weight is the value that rated load in the table deducts the weight of hook block and other lifting tools.

2. Rated hoisting load in this table is the weight lifted from level and hard ground.

3. The italic values in grey filling table means the operating condition under which standard counterweight and additional counterweight are included.



Fixed Jib Load Charts 10/10									kg(lb)×1000
Main Boom Length m(ft)	63m (206'8")								
Fixed Jib Length m(ft)	13m (42'8")				19m (62'4")				
Jib Angle Radius m(ft)	15°		30°		15°		30°		
18m (59'1")	18.7/11.0 (61'4"/24.3)	<i>18.7/11.5 (61'4"/25.4)</i>							
20m (65'7")	11.0 (24.3)	<i>11.5 (25.4)</i>			21.3/7.2 (69'11"/15.9)	<i>21.3/7.5 (69'11"/16.5)</i>			
22m (72'2")	11.0 (24.3)	<i>11.5 (25.4)</i>	8.0 (17.6)	<i>8.4 (18.5)</i>	7.2 (15.9)	<i>7.5 (16.5)</i>			
24m (78'9")	11.0 (24.3)	<i>11.5 (25.4)</i>	8.0 (17.6)	<i>8.4 (18.5)</i>	7.2 (15.9)	<i>7.5 (16.5)</i>	24.2/5.7 (79'5"/12.6)	<i>24.2/6.0 (79'5"/13.2)</i>	
26m (85'4")	11.0 (24.3)	<i>11.5 (25.4)</i>	8.0 (17.6)	<i>8.4 (18.5)</i>	7.2 (15.9)	<i>7.5 (16.5)</i>	5.7 (12.6)	<i>6.0 (13.2)</i>	
28m (91'10")	29.9/11.0 (98'1"/24.3)	<i>29.9/11.5 (98'1"/25.4)</i>	8.0 (17.6)	<i>8.4 (18.5)</i>	7.2 (15.9)	<i>7.5 (16.5)</i>	5.7 (12.6)	<i>6.0 (13.2)</i>	
30m (98'5")	9.4 (20.7)	<i>9.8 (21.6)</i>	8.0 (17.6)	<i>8.4 (18.5)</i>	7.2 (15.9)	<i>7.5 (16.5)</i>	5.7 (12.6)	<i>6.0 (13.2)</i>	
32m (104'12")	9.1 (20.1)	<i>9.5 (20.9)</i>	8.0 (17.6)	<i>8.4 (18.5)</i>	7.2 (15.9)	<i>7.5 (16.5)</i>	5.7 (12.6)	<i>6.0 (13.2)</i>	
34m (111'7")	8.2 (18.1)	<i>8.6 (19)</i>	35.1/8.0 (115'2"/17.6)	<i>35.1/8.4 (115'2"/18.5)</i>	7.2 (15.9)	<i>7.5 (16.5)</i>	5.7 (12.6)	<i>6.0 (13.2)</i>	
36m (118'1")	7.8 (17.2)	<i>8.2 (18.1)</i>	7.7 (17)	<i>8.0 (17.6)</i>	7.2 (15.9)	<i>7.5 (16.5)</i>	5.7 (12.6)	<i>6.0 (13.2)</i>	
38m (124'8")	7.4 (16.3)	<i>7.7 (17)</i>	7.2 (15.9)	<i>7.5 (16.5)</i>	7.2 (15.9)	<i>7.5 (16.5)</i>	5.7 (12.6)	<i>6.0 (13.2)</i>	
40m (131'3")	6.7 (14.8)	<i>7.0 (15.4)</i>	6.5 (14.3)	<i>6.8 (15)</i>	6.4 (14.1)	<i>6.7 (14.8)</i>	5.7 (12.6)	<i>6.0 (13.2)</i>	
42m (137'10")	6.2 (13.7)	<i>6.5 (14.3)</i>	6.1 (13.4)	<i>6.4 (14.1)</i>	6.1 (13.4)	<i>6.4 (14.1)</i>	5.7 (12.6)	<i>6.0 (13.2)</i>	
44m (144'4")	6.0 (13.2)	<i>6.3 (13.9)</i>	5.7 (12.6)	<i>6.0 (13.2)</i>	5.7 (12.6)	<i>6.0 (13.2)</i>	45.3/5.7 (148'7"/12.6)	<i>45.3/6.0 (148'7"/13.2)</i>	
46m (150'11")	5.6 (12.3)	<i>5.9 (13)</i>	5.5 (12.1)	<i>5.7 (12.6)</i>	5.4 (11.9)	<i>5.6 (12.3)</i>	5.2 (11.5)	<i>5.4 (11.9)</i>	
48m (157'6")	5.3 (11.7)	<i>5.5 (12.1)</i>	5.1 (11.2)	<i>5.3 (11.7)</i>	5.0 (11)	<i>5.2 (11.5)</i>	4.9 (10.8)	<i>5.1 (11.2)</i>	
50m (164'0")	5.2 (11.5)	<i>5.4 (11.9)</i>	5.0 (11)	<i>5.2 (11.5)</i>	4.9 (10.8)	<i>5.1 (11.2)</i>	4.7 (10.4)	<i>4.9 (10.8)</i>	
52m (170'7")	5.0 (11)	<i>5.2 (11.5)</i>	4.7 (10.4)	<i>4.9 (10.8)</i>	4.7 (10.4)	<i>4.9 (10.8)</i>	4.6 (10.1)	<i>4.8 (10.6)</i>	
54m (177'2")	4.3 (9.5)	<i>4.5 (9.9)</i>	4.1 (9)	<i>4.3 (9.5)</i>	4.1 (9)	<i>4.3 (9.5)</i>	4.0 (8.8)	<i>4.2 (9.3)</i>	
56m (183'9")	55.7/3.8 (182'9"/8.4)	<i>55.7/4.0 (182'9"/8.8)</i>	55.7/3.7 (182'9"/8.2)	<i>55.7/3.9 (182'9"/8.6)</i>	55.7/3.6 (182'9"/7.9)	<i>55.7/3.8 (182'9"/8.4)</i>	55.7/3.5 (182'9"/7.7)	<i>55.7/3.7 (182'9"/8.2)</i>	
Counterweight kg(lb)×1000	42 (92.6)	(42+3) (92.6+6.6)	42 (92.6)	(42+3) (92.6+6.6)	42 (92.6)	(42+3) (92.6+6.6)	42 (92.6)	(42+3) (92.6+6.6)	

Note: 1. The actual hoisting weight is the value that rated load in the table deducts the weight of hook block and other lifting tools.

2. Rated hoisting load in this table is the weight lifted from level and hard ground.

3. The italic values in grey filling table means the operating condition under which standard counterweight and additional counterweight are included.