

General Specifications

Link-Belt® 100-ton (90.70 metric ton)

Wire rope truck crane

HC-218A

GENERAL INFORMATION ONLY

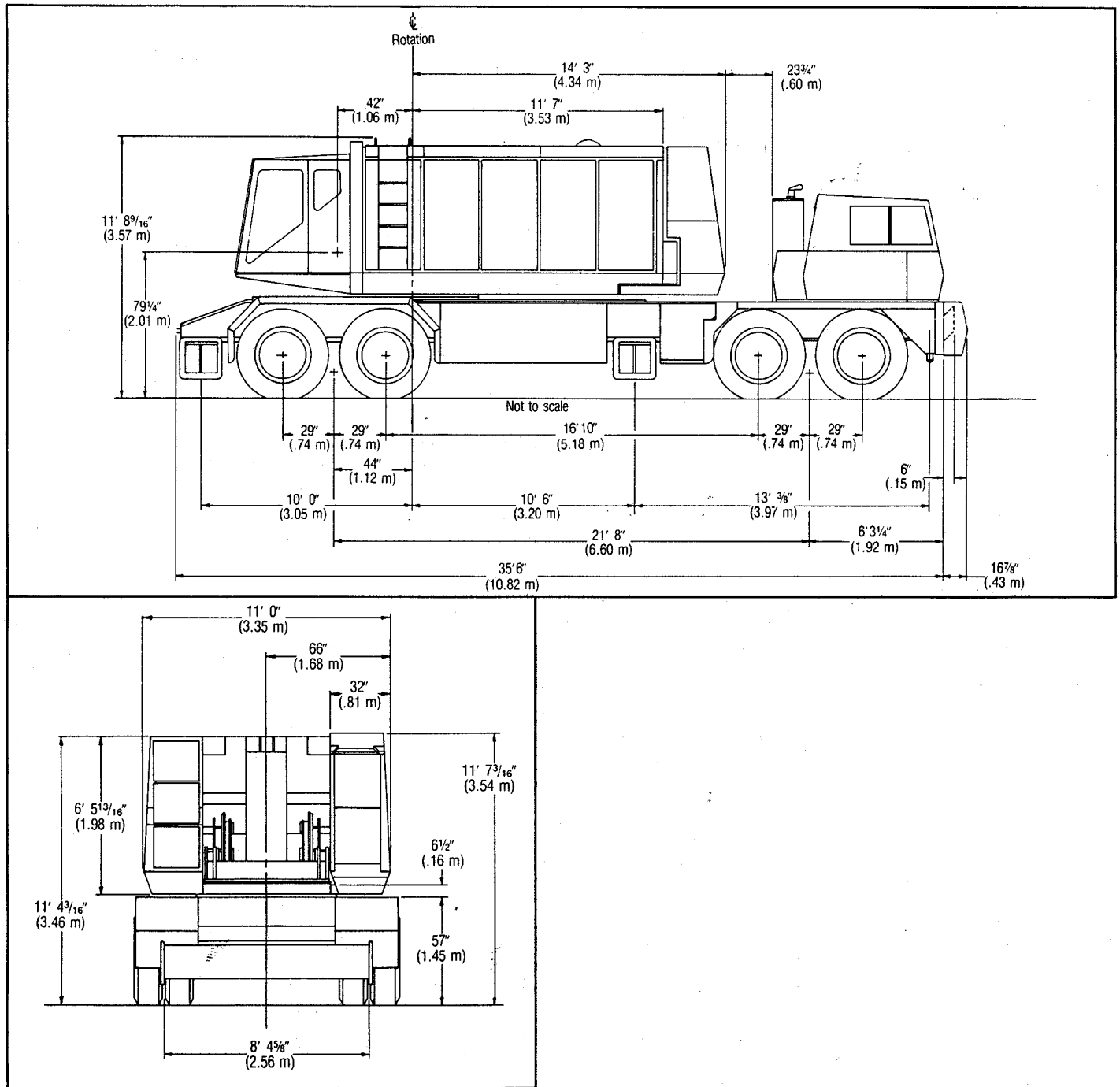

General dimensions	Feet	meters
Overall width, outriggers extended, (over floats)	22' 6"	6.86
Overall width, outriggers extended, (centerline of jacks)	20' 0"	6.10
Overall width, outriggers retracted, (floats removed)	11' 0"	3.35
Minimum ground clearance	8½"	.21
Ground clearance under upper counterweight with machine on tires	58¾"	1.48
Counterweight tailswing, across corners of counterweight	15' ¾"	4.65
Upper cab overall width	11' 0"	3.35
Basic boom length — open throat	40' 0"	12.19
— hammerhead	30' 0"	9.14
— tapered tip	90' 0"	27.43
Radius of boomfoot pin	42"	1.07
Height of boomfoot pin	79¼"	2.02

General dimensions	Feet	meters
Overall length with basic length boom in travel position over rear of carrier with bumper counterweight — open throat boom	71' 1"	21.67
— hammerhead boom	59' 10½"	18.24
— tapered tip boom	See note	
Overall length with basic length boom in travel position over front of carrier — open throat boom	59' ¾"	18.07
— hammerhead boom	48' 2"	14.68
— tapered tip boom	See note	
Height over boom live mast with basic length boom in travel position over rear of carrier	—	—
— open throat boom	11' 10"	3.61
— hammerhead boom	11' 8½"	3.57
— tapered tip boom	See note	
Height over boom live mast with basic length boom in travel position over front of carrier	—	—
— open throat boom	14' 8"	4.47
— hammerhead boom	14' 6"	4.42
— tapered tip boom	See note	

Note: Boom with tapered tip top section cannot be traveled over the road.

Axle loadings — approximate

Based on HC-218A crane upper equipped with 21,000# (9 526 kg) counterweight "A", boom lowering planetary, rear drum load lowering clutch, GM 6-71N diesel with single stage torque converter*, mounted on FMC 8x4, 11' 0" (3.35 m) wide, 260" (6.60 m) wheelbase carrier with GM 6V92-TA diesel, 14:00x24 J (18-ply rating) transport type tires, hydraulic outriggers front and rear, 4 floats in storage racks, fenders, and 13,500# (6 124 kg) front bumper counterweight.	Basic machine gross weight		Upper facing front				Upper facing rear				
	**	Lbs.	kg	Front		Rear		Front		Rear	
		Lbs.	kg	Lbs.	kg	Lbs.	kg	Lbs.	kg	Lbs.	kg
A	56,630	25 687	- 9,580	- 4 346	66,210	30 033	28,750	13 041	27,880	12 646	
B	62,130	28 182	+ 37,650	+ 17 078	24,480	11 104	37,650	17 078	24,480	11 104	
C	118,760	53 870	+ 28,070	+ 12 733	90,690	41 137	66,400	30 119	52,360	23 751	
Adjust axle loadings accordingly for the following components:	Component weights		Front		Rear		Front		Rear		
	Lbs.	kg	Lbs.	kg	Lbs.	kg	Lbs.	kg	Lbs.	kg	
Upper machinery —											
Boom lowering clutch (high speed)	+ 400	+ 181	- 50	- 23	+ 450	+ 204	+ 180	+ 81	+ 220	+ 100	
Boomhoist wire rope — 530' (161.54 m), ¾" (19.05 mm) diameter, Type "N"	+ 550	+ 249	- 70	- 32	+ 620	+ 281	+ 250	+ 113	+ 300	+ 136	
Front drum load lowering clutch	+ 400	+ 181	+ 40	+ 18	+ 360	+ 163	+ 90	+ 40	+ 310	+ 141	
Front drum planetary — load hoist	+ 450	+ 204	+ 50	+ 23	+ 400	+ 181	+ 100	+ 45	+ 350	+ 159	
Front drum planetary — load lowering	+ 450	+ 204	+ 50	+ 23	+ 400	+ 181	+ 100	+ 45	+ 350	+ 159	
Front drum wire rope — 890' (271.27 m), 7/8" (22.23 mm) diameter, Type "N"	+ 1,260	+ 572	+ 140	+ 64	+ 1,120	+ 508	+ 290	+ 132	+ 970	+ 440	
Rear drum planetary — load hoist	+ 450	+ 204	- 10	- 5	+ 460	+ 209	+ 160	+ 73	+ 290	+ 131	
Rear drum planetary — load lowering	+ 450	+ 204	- 10	- 5	+ 460	+ 209	+ 160	+ 73	+ 290	+ 131	
Rear drum wire rope — 890' (271.27 m), 7/8" (22.23 mm) diameter, Type "N"	+ 1,260	+ 572	- 30	- 13	+ 1,290	+ 585	+ 460	+ 209	+ 800	+ 363	
Third drum (with front drum lowering clutch and gear to power third drum)	+ 2,100	+ 953	+ 410	+ 186	+ 1,690	+ 767	+ 300	+ 136	+ 1,800	+ 817	
Third drum — as above, but with third drum load lowering clutch	+ 400	+ 181	+ 90	+ 40	+ 310	+ 141	+ 50	+ 22	+ 350	+ 159	
Third drum wire rope — 505' (153.92 m), ¾" (19.05 mm) diameter, Type "N"	+ 530	+ 240	+ 110	+ 50	+ 420	+ 191	+ 70	+ 32	+ 460	+ 209	
Upper counterweight "A"	- 21,000	- 9 526	+ 9,170	+ 4 159	- 30,170	- 13 685	- 16,280	- 7 385	- 4,720	- 2 141	
Upper counterweight "B"	+ 12,000	+ 5 443	- 5,240	- 2 377	+ 17,240	+ 7,820	+ 9,300	+ 4 218	+ 2,700	+ 1 225	
Optional Cummins N855-P220 diesel with three-stage torque converter	+ 1,060	+ 481	- 300	- 136	+ 1,360	+ 617	+ 660	+ 299	+ 400	+ 181	
Crane booms and auxiliary equipment —											
40' (12.19 m) basic open throat boom with accessories	+ 5,200	+ 2 359	+ 8,330	+ 3 779	- 3,130	- 1 420	- 6,570	- 2 980	+ 11,770	+ 5 339	
20' (6.10 m) open throat boom top section only	- 3,380	- 1 533	- 6,670	- 3 066	+ 3,380	+ 1 737	+ 5,610	+ 2 545	- 8,990	- 4 078	
30' (9.14 m) basic hammerhead boom with accessories	+ 4,730	+ 2 146	+ 6,140	+ 2 785	- 1,410	- 639	- 4,540	- 2 059	+ 9,270	+ 4 205	
Boom stops	+ 770	+ 349	+ 230	+ 104	+ 540	+ 245	+ 40	+ 18	+ 730	331	
Boom live mast (extended and horizontal), bridle and spreader bar	+ 3,600	+ 1 633	+ 3,860	+ 1 751	- 260	- 118	- 2,640	- 1 198	+ 6,240	+ 2 831	
Carrier —											
Front outrigger box, beams and jacks	- 5,100	- 2 313	- 3,220	- 1 460	- 1,880	- 853	- 3,220	- 1 460	- 1,880	- 853	
Rear outrigger box, beams and jacks	- 5,100	- 2 313	+ 1,490	+ 676	- 6,590	- 2 989	+ 1,490	+ 676	- 6,590	- 2 989	
Front and rear outrigger floats (4)	- 500	- 227	- 140	- 64	- 360	- 163	- 140	- 64	- 360	- 163	
Front center hydraulic jack	+ 130	+ 59	+ 170	+ 77	- 40	- 18	+ 170	+ 77	- 40	- 18	
Front center hydraulic jack float (1)	+ 130	+ 59	+ 60	+ 27	+ 70	+ 32	+ 60	+ 27	+ 70	+ 32	
Bumper counterweight "A"	- 13,500	- 6 124	- 17,780	- 8 065	+ 4,280	+ 1 941	- 17,780	- 8 065	+ 4,280	+ 1 941	
Optional Cummins NTC-290 diesel	+ 740	+ 336	+ 800	+ 363	- 60	- 27	+ 800	+ 363	- 60	- 27	
Optional 14:00x24L (20-ply rating) HCT highway type tires	+ 970	+ 440	+ 320	+ 145	+ 650	+ 295	+ 320	+ 145	+ 650	+ 295	
Optional 14:00x24 J (18-ply rating) Goodyear SRL-1 tires	+ 1,330	+ 603	+ 440	+ 200	+ 890	+ 403	+ 440	+ 200	+ 890	+ 403	

*GM6-71N diesel with three-stage converter — weight approximately same as GM 6-71N with single stage converter.

**A — upper, B — carrier, C — total weight of upper and carrier.

General specifications

Carrier —

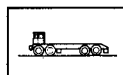

Type —

FMC; 8 x 4 drive, 260" (6.60 m) wheelbase, 11'0" (3.35 m) wide.

Frame — Main members heat treated alloy steel; machined surface for mounting outer race of turntable bearing.

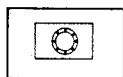

Turntable bearing —

Outer race, with integral external tooth swing (ring) gear, bolted to machined surface on carrier deck.

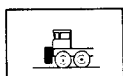

Bumper counterweight —

Mounts on front bumper counterweight hooks; easily removable. Refer to lifting capacity charts for counterweight requirements.

Bumper counterweight "A" — 13,500# (6 124 kg).

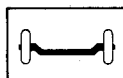

Front axles —

Shuler FTCA-34L; bogie beam mounted tandem axles, single wheels. Track—104" (2.64 m).

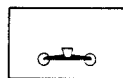

Bogie —

Hendrickson; rubber mounted equalizer beams, rubber bushed torque rods.

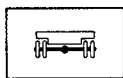

Rear axles —

Clark Planetary BD-65200, bogie mounted tandem axles, dual wheels. Track — 100-5/8" (2.56 m).

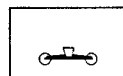

Bogie —

Hendrickson; bronze bushed equalizer beams, rubber bushed torque rods.

Tag axle — Optional; Transport Trailer, equipped with air brakes, 10:00 x 20F (12-ply rating) dual tires.

Wheels and rims — Front; cast spoke type. Rear; integral with planetary hubs.



Tires —

Single tires front; dual tires rear.

Standard — 14:00 x 24J (18-ply rating), transport type tread.

Optional — 14:00 x 24L (20-ply rating). General HCT Nygen; 14:00 x 24J (18-ply rating) Goodyear SRL-1.

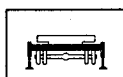

Outriggers —

Full width, double box, front and rear; pin connected to carrier frame. Hydraulically operated beams and jack cylinders individually controlled from each side of carrier. Hydraulic power supplied by PTO-driven hydraulic pump. Check valve at each jack cylinder. Optional — outrigger beam/jack controls in crane upper cab.

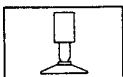

Front center hydraulic jack —

Optional; jack with float available — required for handling 360° swing rated capacities.

Floats — Low profile, alloy steel, lightweight; 30" (.76 m) square base.

Trailer hitch — Optional; includes air and electric connections at rear of carrier for trailer lights and air brakes.

Brakes — 8-wheel air brakes.

Service — Dual diaphragm air chambers on four rear wheels, single diaphragm air chambers on four front wheels.

Size and area — Rear wheels; 20" x 7" (.51 x .18 m); total effective lining area, 574 square inches (3 073 cm²) per axle. Front wheels; 17 1/4" x 4" (.44 x .10 m); total effective lining area, 248 square inches (1 601 cm²) per axle.

Parking — Brakes on four rear wheels applied and air chamber push rods automatically and mechanically locked with air control valve on dash.

Emergency — Bendix-Westinghouse DD-3 air brakes on four rear wheels apply and mechanically lock automatically if air pressure drops to 40 p.s.i. (275.80 kPa) in system. Emergency brake may be manually applied any time by hand control of dash-mounted air control valve.



Steering —

Power hydraulic assist. Ross HPS70; 18" (.46 m) diameter steering wheel.



Engines —

Diesel; 12-volt alternator, starter, pressure lubrication, hydraulic pump, dry type air cleaner, and 14.5 c.f.m. (.41 m³/min) air compressor.

Standard — GM 6V-92TA diesel, 6 cylinder, 2 cycle, 4.84" (.12 m) bore, 5" (.13 m) stroke, 552 cu. in. (9 047 cm³) displacement, 318 brake horsepower at 2,100 r.p.m. governed load speed. Peak torque 914 ft. lbs. (126.41 kgm) at 1,400 r.p.m. Electric shutdown.

Optional — Cummins NTC-290 diesel, 6 cylinder, 4 cycle, 5 1/2" (.14 m) bore, 6" (.15 m) stroke, 855 cu. in. (14 013 cm³) displacement, 290 brake horsepower at 2,100 r.p.m. governed load speed. Peak torque 930 ft. lbs. (128.62 kgm) at 1,300 r.p.m. Electric shutdown.

Clutch — Lipe-Rollway, 14" (.36 m), 2-plate, dry disc.

Transmissions —

Main — Eaton RTO-915; 15 speeds forward, 3 reverse.

Auxiliary — Eaton AT-1202; 2-speed, midship mounting.

Universals — Mechanics type drive tubes; needle bearings.

Cab — One-man, offset, fully enclosed. Rubber suspension mounted bucket seat with seat belt. Noise absorbing insulation with vinyl covering, sound reduction headliner, carpet floor mat; isolated from engine compartment, rubber mounted for sound level reduction. Instrument panel and dash includes speedometer, odometer, voltmeter, and gauges for fuel, engine temperature, air and oil pressures. Low air pressure warning buzzer, key locking switch, pushbutton starter, throttle control, tachometer, fire extinguisher, heater and defroster, 2-speed electric windshield wiper, and windshield washer.

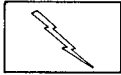

Electrical system —

12-volt; including dual sealed beam headlights, directional signals with 4-way flashing system, stop and tail lights, clearance lights, horn, lighting of instrument panel, dome light, headlight dimmer switch, and two 12-volt, 225 ampere hour batteries. Individual switches provide circuit control for hydraulic outrigger solenoid valves; one control station on each side of carrier.

Standard auxiliary equipment — West Coast rear view mirrors, boom guide, lug wrench, 2-way reading bubble levels at 4 positions on carrier frame, tire gauge and tire inflation hose. High pressure lube fittings at all bearing points. Two 45 gallon (170.31 liter) capacity fuel tanks, hand grab rails, carrier deck access ladder, back-up alarm, skid-resistant finish on carrier deck.

Carrier speeds —

Based on GM 6V-92TA or Cummins NTC-290 engines running at 2,100 r.p.m. governed full load speed.

Gear		Main-Eaton RTD-915	Auxiliary — Eaton AT-1202			
			1.00:1.00		2.036:1.00	
			M.p.h.	km/hr	M.p.h.	km/hr
High	10th	.81	43.6	70.15	21.4	34.43
	9th	1.00	35.3	56.80	17.4	28.00
	8th	1.26	28.0	45.05	13.8	22.20
	7th	1.59	22.2	35.72	10.9	17.54
	6th	2.04	17.3	27.84	8.5	13.68
	Reverse	2.21	16.0	25.74	7.9	12.71
Low	5th	2.59	13.6	21.88	6.7	10.78
	4th	3.20	11.0	17.70	5.4	8.69
	3rd	4.04	8.7	14.00	4.3	6.92
	2nd	5.10	6.9	11.10	3.4	5.47
	1st	6.51	5.4	8.69	2.6	4.18
	Reverse	7.06	5.0	8.05	2.5	4.02
Deep Reduction	5th	3.87	9.1	14.64	4.5	7.24
	4th	4.78	7.4	11.91	3.6	5.79
	3rd	6.03	5.9	9.49	2.9	4.67
	2nd	7.62	4.6	7.40	2.3	3.70
	1st	9.73	3.6	5.79	1.8	2.90
	Reverse	10.55	3.3	5.31	1.6	2.57

Creep speed in deep reduction low (1st), based on GM 6V-92TA peak engine torque of 1,400 r.p.m. — 1.2 m.p.h. (1.93 km/hr.); based on Cummins NTC-290 peak engine torque of 1,300 r.p.m. — 1.1 m.p.h. (1.77 km/hr.)
 Note: Rear axle ratio — 8.667 to 1.0.

Turning ability —

Turning circle diameter	Curb clearance circle diameter	Vehicle clearance circle diameter	
		Over outside of front bumper	Over outside of front bumper counterweight "A"
Centerline of outer front tire	Outside of outer front tire		
111' 0" (33.83 m)	112' 0" (34.14 m)	117' 0" (35.66 m)	118' 0" (35.97 m)

Revolving upperstructure —



Frame —

All welded, stress relieved, precision machined; machinery side housings welded integral with frame.

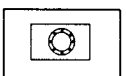

Turntable bearing —

Inner race of bearing bolted to machined surface on underneath side of frame.

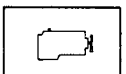

Engines —

Diesel; full pressure lubrication, oil filter, air cleaner, hour meter, foot and optional hand throttles. Manual control shutdown cable for GM engine, electrical shutdown for Cummins engine.

Engine specifications	GM 6-71N with single stage torque converter ①	GM 6-71N with three stage torque converter ②	Cummins N855-P220 with three stage torque converter ②
Number cylinders	6	6	6
Bore and stroke	4¼" x 5" (.108 x .13 mm)	4¼" x 5" (.108 x .13 mm)	5½" x 6" (.13 x .152 m)
Piston displacement (cu. in.)	425.6 (6 975.6 cm³)	425.6 (6 975.6 cm³)	855 (14 013.5 cm³)
High idle speed r.p.m.	1950	1940	1980
Engine r.p.m. at full load speed	1800	1800	1800
Net engine horsepower at full load speed	165	165	168
Peak torque (foot pounds)	1,400 (1898 joule)	2,360 (3200 joule)	2,402 (3257 joule)
Peak torque r.p.m.	Output shaft stall	Output shaft stall	Output shaft stall
Electrical system	12-volt	12-volt	12-volt
Batteries	One/12-volt	One/12-volt	Two/12-volt
Clutch or power take-off	Disconnect between engine and converter	Disconnect between engine and converter	Disconnect between engine and converter
Transmission —	—	—	—
Number chain wheel teeth	161	161	161
Number engine pinion teeth	28	28	28

① Allison #TCDO 475 torque converter
 ② Twin Disc #CO-10066 TCI torque converter

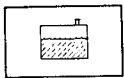

Fuel tank —

75-gallon (284 liters) capacity fuel tank equipped with fuel gauge and fill pipe with flame arrester unit.

Power train —

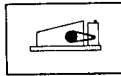

Transmission —

Quadruple roller chain enclosed in oil tight chain case with integral lubrication system.

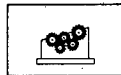

Machinery gear train —

"Full Function" design, two-directional power available to all operating shafts; shafts mounted on anti-friction bearings in precision bored machinery side housings. All load hoist, swing, and boomhoist functions independent of one another. Components such as gears, pinions, chain wheels, brake drums and clutch spiders involute splined to shafts. Drum gear/clutch drum assemblies bolted together and mounted on shafts on anti-friction bearings. Machine-cut teeth on drum gears, pinions, spur gears, and chain wheel. Chain wheel and pinion fully enclosed and running in oil.

Principal operating functions —

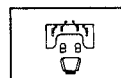

Control system —

Speed-o-Matic® power hydraulic control system; a variable pressure system requiring no bleeding. Operating pressure transmitted through oil to all 2-shoe clutch cylinders, and other hydraulic cylinders as required. System includes constant displacement, engine driven, vane type hydraulic pump to provide constant flow of oil, accumulator to maintain system operating pressure, unloader valve to control pressure in accumulator, relief valve to protect pressure buildup in system, full-flow filter with 40 micron disposable filter element, and variable pressure control valves to control drum clutches.

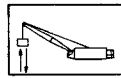

Load hoisting and lowering —

Wire rope drum gear train (front and rear main, and optional third, operating drums) powered by chain transmission from engine. Tandem design drums.

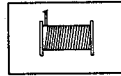

Load hoist drums —

Front and rear main operating drums — One-piece, 17¼" (.44 m) root diameter smooth drums; involute splined to shafts. Extended length shafts permit installation of power load lowering clutches; special length shaft required for, and furnished with, optional planetary drive units for either or both drums.

Third operating drum — Optional; mounts forward of front main operating drum. One-piece, 11¼" (.29 m) root diameter smooth drum; involute splined to shaft. Note: Installation of optional third operating drum includes required installation of power load lowering clutch/gear unit on front main operating drum shaft.



Drum clutches —

Speed-o-Matic power hydraulic 2-shoe clutches. Internal expanding, lined aluminum alloy shoes; clutch spiders splined to shafts, clutch drums bolted to drum spur gears and mounted on shafts on anti-friction bearings. Front, rear, and optional third, main operating drum clutches, swing clutches, and boom hoist clutch are fully interchangeable.

Load hoist clutches — Front and rear main, and optional third, operating drums — 20" (.51 m) diameter, 5" (.13 m) face width.

Load lowering clutches — Standard on rear main drum; optional on front main, and optional third, operating drums. Clutches 20" (.51 m) diameter, 5" (.13 m) face width.

Drum planetary drive units — Optional; available for load hoist or lowering on either or both front and rear main operating drums. Planetary units mount (on extended drum shafts) between drum spur gears and 2-shoe clutch drums. Available for **either** increase or decrease of standard load hoist or lowering line speeds — choice of increased or decreased line speeds predetermined by customer at time of order. Two-shoe clutches control standard line speeds. Planetary drive units controlled by external contracting band brakes through push button located on appropriate control lever.

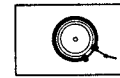

Drum brakes —

Two-piece, external contracting band; mechanically foot pedal operated. Foot pedals equipped with latch to permit locking brakes in applied position.

Front and rear main drums — brakes 34" (.86 m) diameter, 5" (.13 m) face width.

Optional third drum — brake 28" (.71 m) diameter, 5" (.13 m) face width.

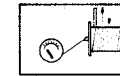

Drum rotation indicators —

Standard for front and rear main operating drums. Two solenoid operated indicator buttons, recessed in drum clutch control lever handles; one button pulsates when rope drums rotate in one direction, the other button pulsates when drums rotate in opposite direction. Operator can adjust pulsations to determine either rope speed off drum or hook block speed based on specific number of parts of load hoist rope.

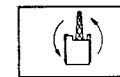

Swing system —

Spur gear driven; single bevel gears (enclosed and running in oil) on horizontal and vertical swing shafts. Swing pinion, involute splined to vertical swing shaft, meshes with external teeth of swing gear integral with outer race of turntable bearing.



Swing clutches —

20" (.51 m) diameter, 5" (.13 m) face width; aluminum alloy shoes.

Swing brake — External contracting band; spring applied, hydraulically released by operator controlled lever. Brake drum involute splined to vertical swing shaft; brake 20" (.51 m) diameter, 3¼" (82.6 mm) face width.

Swing lock — Mechanically controlled pawl engages external teeth of turntable bearing swing (ring) gear.

Maximum swing speed — 3.0 r.p.m.

GENERAL INFORMATION ONLY

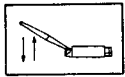

Boom hoist/ lowering system —

Independent, spur gear driven. Precision control — hoisting through power hydraulic 2-shoe clutch; lowering through low speed planetary drive unit.

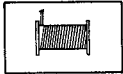

Boomhoist drum —

1 1/4" (.31 m) root diameter, smooth; involute splined to shaft.

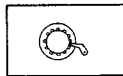

Boomhoist drum locking pawl —

Operator controlled; spring applied, mechanically released.



Boom hoist clutch —

20" (.51 m) diameter, 5" (.13 m) face width.

Boom lowering planetary — Mounts on outer end of shaft; planetary external contracting band brake hydraulically controlled by boom hoist/lowering control lever.



Boom lowering clutch —

Optional; in addition to planetary boom lowering. Two-shoe clutch permits higher speed boom lowering mounted on shaft outside planetary unit, clutch drum bolted to outer face of planetary housing. Clutch power hydraulically controlled by depressing solenoid push button located on boom hoist/lowering control lever.

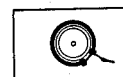

Boom hoist/lowering brake —

External contracting band; spring applied, hydraulically released as hoist clutch or lowering planetary are engaged. Brake drum involute splined to shaft; brake 28" (.71 m) diameter, 5" (.13 m) face width.

Boomhoist limiting device — Provided to restrict hoisting boom beyond recommended minimum radius; located on exterior right-hand side of operator's cab.



Electrical system —

Battery, 12-volt, 225 ampere hour, either one or two batteries depending on engine. **Optional** — battery lighting system, including two sealed beam automotive type adjustable headlights located on cab front roof, one interior cab light and automotive type wiring. **Optional** — additional 50 watt sealed beam automotive type headlight mounted on boom. (Three maximum quantity recommended.) **Optional** — Onan independent light plant with single cylinder four cycle, air cooled diesel engine with remote electric starting, 3,000 watt, 120-volt, single-phase, 60 cycles A.C. including wiring in conduit, three interior cablights, trouble lamp with cord and two 300 watt adjustable floodlights on cab front roof. **Optional** — additional 300 watt floodlights available for mounting on cab and boom.

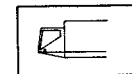

Operator's cab —

Environmental cab, modular type isolated from upper machinery cab. Tinted tempered glass panels in all windows, hand grab rail, adjustable, cushioned seat with head rest, arm rests on control consoles, dry chemical fire extinguisher. Cab heater/defroster and windshield wiper optional.



Machinery cab —

Equipped with warning horn, hinged doors on two sides, rear, and top. Removable panels for machinery access, roof-top access ladder, and skid resistant finish on roof.

Gantry — low type, mounted at top rear of machinery side housings supports boom suspension system.

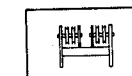

Gantry bail —

Contains eight 12" (.30 m) root diameter sheaves, mounted on anti-friction bearings for 16-part boomhoist wire rope reeving.

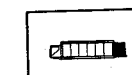

Counterweight —

"A" counterweight — 21,000# (9 526 kg); "B" counterweight — 12,000# (5 443 kg). (Refer counterweight requirement instructions with lifting capacity chart.)

Booms and jibs



Boom —

Tubular; basic boom two-piece 40' (12.19 m) long with open throat, three-piece 30' (9.14 m) long with hammerhead, and 90' (27.43 m) long with tapered tip top sections. Boom 60" (1.52 m) wide, 50" (1.27 m) deep at centerline of connections. Alloy steel, round tubular chords 3" (76.20 mm) outside diameter on 60" (1.52 m) centers.

Base section — 20' (6.10 m) long. Boom feet 2 1/2" (63.5 mm) thick on 60" (1.52 m) centers.

Boom extensions — one of two types required. Type "H" **must be used** for first 60' (1.52 m) of extensions beyond base section — available in 10' (3.05 m), 20' (6.10 m) and 30' (9.14 m) lengths. Type "F" **must be used** at point 80' (24.38 m) from boom feet and beyond — available in 10' (3.05 m), 15' (4.57 m), 20' (6.10 m), 30' (9.14 m) and 40' (12.19 m) lengths. Extended hub on female connections serves as anchor for link used to attach jib staylines, boom suspension pendants for boom assembly, and boom midpoint suspension pendants.

Boom connections — In-line, tapered pins.

Boom folding section — Available for folding boom with open throat top section only; 10' (3.05 m) long. Includes lifting hubs for boom folding shaft; construction similar to type "H" boom extension.

Boom top section — Open throat; 20' (6.10 m) long.

— **Boompoin machinery**. Five 21" (.53 m) root diameter head sheaves mounted on anti-friction bearings.

Boom top section — Hammerhead; 5' (1.52 m) long; requires use also of 5' (1.52 m) long tapered extension immediately below the hammerhead top section.

— Tapered extension. 5' (1.52 m) long; tapered from 60" (1.52 m) wide, 50" (1.27 m) deep to 54" (1.37 m) wide, 44" (1.12 m) deep at centerline of connections. (For use with hammerhead boomtop section only).

— **Boompoin machinery**. Five head sheaves (seven available for International) plus one or two (optional) idler sheaves to guide load hoist wire rope on to head sheaves. All sheaves 1 1/2" (.47 m) root diameter, mounted on anti-friction bearings.

Boom top section – Tapered tip; 40' (12.19 m) long, tapered from 60" (1.52 m) wide, 50" (1.27 m) deep at lower end to 32" (.81 m) wide 12¾" (.32 m) deep at top end. Requires use of 30' (9.14 m) of type "H" extensions, immediately below the tapered tip top section to obtain basic 90' (27.43 m) length boom.

— **Pendant spreader bar.** Prevents jib back stayline interference with boom suspension pendants. Required for tapered tip booms 150' (45.72 m) through 210' (64.01 m) long when equipped **with** jib. Optional for use with tapered tip booms 150' (45.72 m) through 230' (70.10 m) long **without** jib. Spreader bar **must not** be used with tapered tip booms 90' (27.43 m) through 140' (42.67 m) with or without jib.

— **Boompoint machinery.** Two 25" root diameter head sheaves, mounted on antifriction bearings.

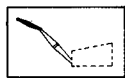

Jib —

Tubular; basic jib two-piece 30' (9.14 m) long; 32" (.81 m) wide, 24" (.61 m) deep at connections. Alloy steel tubular chords 2" (50.80 mm) outside diameter.

Base section – 15'0" (4.57 m) long.

Jib extensions – Available in 15' (4.57 m) length with appropriate length pendants. Maximum boom/jib lengths permitted — open throat boom; 200' (60.96 m) boom plus 60' (18.29 m) jib — hammerhead boom; 200' (60.96 m) boom plus 60' (18.29 m) jib — tapered tip boom; 210' (64.01 m) boom plus 60' (18.29 m) jib.

Connections – In-line, tapered pins.

Tip section – 15'0" (4.57 m) long; single peak sheave 15¼" (.39 m) diameter, mounted on anti-friction bearings. Anchors at jib peak shaft for 2-part load hoist wire rope (whipline). Jib frontstay line anchors suspended from peak shaft.

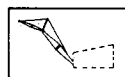

Jib mast —

12'1" (3.69 m) high, mounted on jib base section. Two deflector sheaves mounted within mast to guide whipline; mounted on anti-friction bearings. Two equalizer sheaves mounted on top of mast — one for jib frontstay line, one for jib backstay line.

— **Jib staylines.** Front and rear staylines vary in length depending on degree of jib offset from boom centerline; back staylines attached at bottom end of boom top section on open throat and tapered tip booms, and at a point 20' (6.10 m) or 30' (9.14 m) below peak of hammerhead top section.

— **Jib stops.** Telescoping type; pinned from jib mast to boom top section and from jib mast to jib base section.

Items applicable to all booms and jibs —



Boom stops —

Dual lever-type; pinned to low gantry head shaft and top of boom base section; spring-loaded bumper ends.

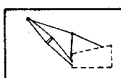

Boom live mast —

Supports boomhoist bridle, boom pendants, and boom midpoint suspension pendants. Hydraulically extends to maximum 24'0" (7.32 m) — required operating position for **all** capacities when using booms with open throat and tapered tip top sections, and for all hammerhead boom capacities with exception of 30' (9.14 m) long hammerhead boom. Mechanically retracts to minimum 20'6" (6.25 m) height — required operating position for **maximum** capacity when using basic 30' (9.14 m) boom with hammerhead top section, and to reduce overall height for travel.

Note: Boom live mast, in extended 24'0" (7.32 m) height, may be used as short boom in machine/boom assembly or dismantling, but is not intended for general crane service. Refer to lifting crane capacity chart for boom live mast lifting capacities.

— **Mast stops.** Incorporated with boom stops; manually positioned when using live mast as short boom.

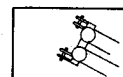

Boomhoist bridle and spreader bar —

Serves as connection for boom suspension system. Bridle contains eight 12" (.30 m) root diameter sheaves, mounted on anti-friction bearings, for 16-part boomhoist wire rope reeving. Bracket attached to bridle contains two 157/8" (.40 m) root diameter, bronze bushed sheaves, to permit reeving wire rope suspension for use of boom live mast as short boom. Spreader bar provides attachment point for boom main pendants and boom midpoint suspension pendants.



Boom angle indicator —

Pendulum type; mounted on boom base section.

Deflector rollers — Deflect load hoist wire rope off boom to avoid chafing; steel rollers mounted on anti-friction bearings. One roller furnished with each boom extension, two with open throat boom top section and three with tapered tip boom top section.

Boom pendants — Standard; furnished for basic boom lengths plus appropriate length pendants with each boom extension.

Boom midpoint suspension pendants — Assist in lifting long booms off ground. Required for all boom lengths exceeding 150' (45.72 m); pendants must connect on boom at point 80' (24.38 m) from boom feet.

Auxiliary equipment —

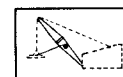

Tagline —

Optional. Spring wound drum type, mounted on crane boom. Rud-O-Matic® model 648, single barrel; cable pull off drum, 60' (18.29 m) to 75' (22.76 m) from neutral.

Load hoist wire ropes — Main load hoist wire rope standard, jib load hoist wire rope (whipline) furnished with machine **only** if jib is ordered.

Hook blocks — Blocks, or weighted ball with swivel hook, optional — refer to price list.

GENERAL INFORMATION ONLY

We are constantly improving our products and therefore reserve the right to change designs and specifications.

